



841 S. 71st Avenue • Phoenix, AZ 85043  
(623) 907-0081  
www.performanceaccessories.com

## 2002 CHEVY AVALANCHE INSTALLATION INSTRUCTIONS - KIT #PA10073

### ⚠WARNING

Installation of a Performance Accessories body lift will change the center of gravity and the handling characteristics of the vehicle. Because of the higher center of gravity and larger tires, the vehicle will handle and react differently both on and off road. You must drive it safely! Extreme care must be taken to prevent vehicle rollover or loss of control, which could result in serious injury or death. Avoid sudden sharp turns or abrupt maneuvers and always make sure all vehicle occupants have their seat belts fastened.

### ⚠WARNING

Read and understand all instructions, warnings, cautions, and notes in this sheet and in your owners manual before you begin the installation of this body lift kit.

### ⚠CAUTION

Proper installation of a Performance Accessories body lift kit requires knowledge of the factory recommended procedures for disassembly and assembly of original equipment components. We recommend that the factory shop manual and any special tools necessary to your vehicle be on hand during the installation. Installation of this body lift kit without proper knowledge of the factory recommended procedures may affect the performance of these components and the safety of your vehicle. We strongly recommend that a certified mechanic familiar with the installation of similar components install this body lift kit.

### ⚠WARNING

This body lift kit should only be installed on vehicles in good working condition. Before installation, the vehicle should be thoroughly inspected for evidence of corrosion or deformation of the sheet metal around the factory body mounts. This body lift kit should not be installed on any vehicle that is suspected to have been in a collision or misused. Off road use of your vehicle with this body lift installed may increase the stress applied to the factory body mounts. We do not recommend that any vehicle with a body lift installed be involved in any extreme off road maneuvers such as jumping. Failure to observe this warning may result in serious personal injury and/or severe damage to your vehicle.

### ⚠WARNING

Many states now have laws restricting bumper heights and vehicle lifts. Local laws should be consulted to determine if the changes you intend to make to your vehicle comply with state laws. Before combining a body lift with a suspension lift, consult an installation professional to see how this will affect your specific application.

### ⚠WARNING

The installation of larger wheel and tire combinations may reduce the effectiveness of the Anti-lock Braking System.

### ⚠WARNING

Always wear eye protection when operating power tools.

### ⚠WARNING

Ensure that your vehicle tires are properly blocked and secured before you begin installation of this lift kit.

### ⚠WARNING

The Supplemental Restraint System (SRS, or air bag) must be deactivated during lift kit installation to avoid accidental air bag deployment while working near SRS sensors and wiring. Do not allow anyone near the air bag during lift kit installation. Accidental deployment can result in serious personal injury or death. Refer to your factory service manual/owner's manual for the recommended procedure to disable the SRS. The SRS must be reactivated before driving the vehicle.

## A. Before you start.

### △NOTE

As you read through this procedure, note that each part referenced has the same callout number throughout. Also, the part number in the text matches the corresponding part number in the art. Kit parts are prefaced by the word *kit* in italics.

### △NOTE

You will find it easier to keep track of hardware if immediately after removal you put the fasteners for each subassembly in a paper lunch bag and write on the bag where they go.

1. Read all warnings and instructions completely and carefully before you begin.
2. Check to make sure the kit is complete (refer to the Parts List, section E).
3. Only install this kit on the vehicle for which it is intended. If anytime during the installation you encounter something different from what is outlined in the instructions, call technical support at (928) 636-0979.
4. Park the vehicle on a clean, dry, flat, level surface and block the tires so the vehicle cannot roll in either direction.
5. Disconnect both battery cables. Disconnect the negative cable (1) first, then the positive cable (2) from the battery (3).
6. Remove cover (4) and the airbag fuse #15 (5) from the fuse panel (6). Fuse locations may vary. Check fuse chart on back of cover (4).

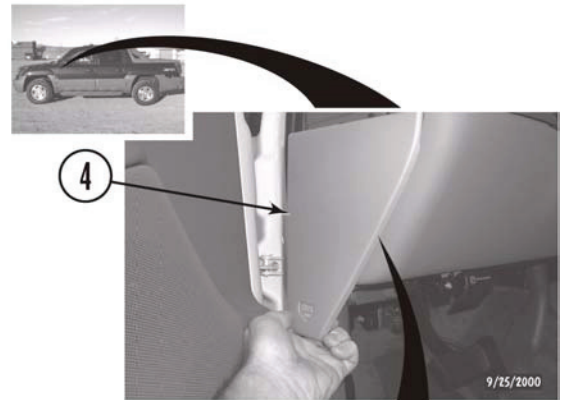
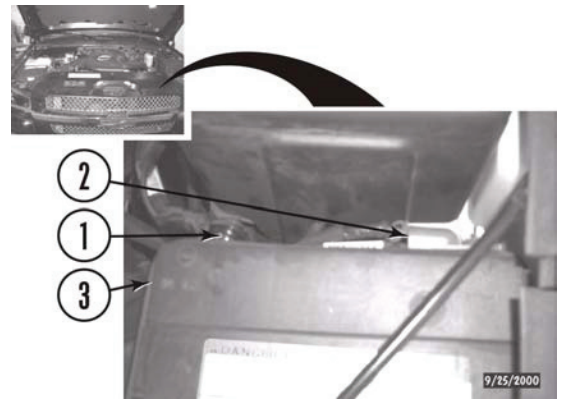

## B. Get ready to install the kit.

1. Remove the grille and front bumper.

a. Remove three popups (7) from grille (8).

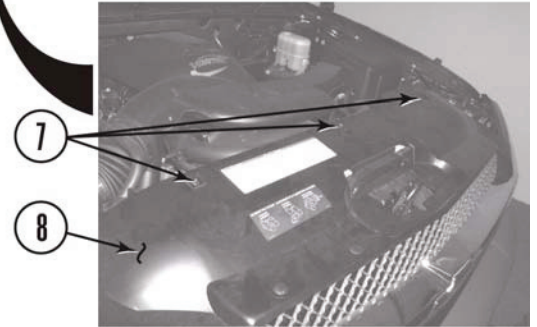
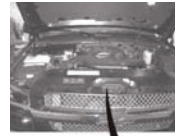

b. Remove eight screws (9) from front outer bumper (10) and two front fenders (11).

c. Remove two bolts with captive washers (12) and bracket (13) from shroud (14).

d. Remove four bolts with captive washers (15) and side brackets (16) from core support mounting pads (17).

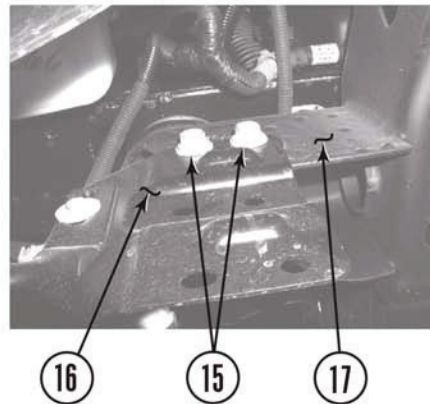
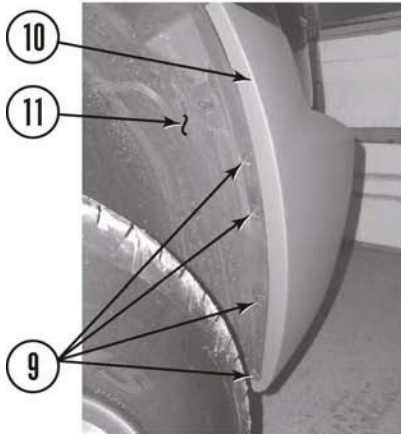

e. Remove four push clips (18) from two bumper brackets (19) and four connectors (20) from two fog lamps (21).

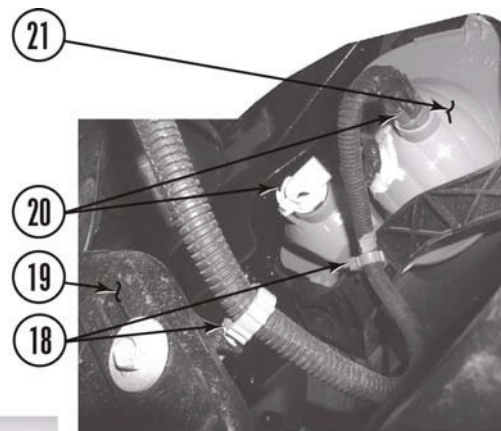

f. Pull front outer bumper (10) forward and remove four clips (22) from two front fenders (11).

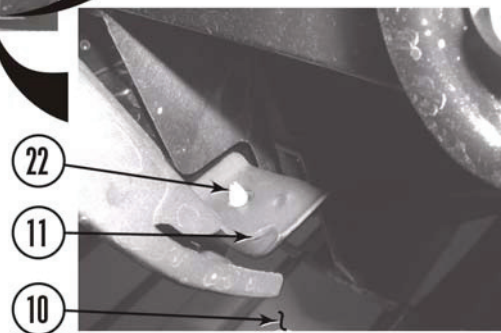

g. Push down on on fourteen clips (23) and remove front outer bumper (10) from two front fenders (11), core support (24), front inner bumper (25), and grille (8).

h. Carefully pull two clips (26) and grille (8) from core support (24).

i. Squeeze two clips (27) and remove grille (8) from two front fenders (11).

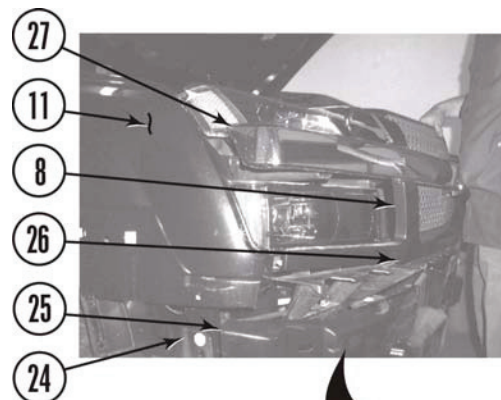



j. Remove four bolts with captive washers (28) and front inner bumper (25) from frame (29).

k. Remove two nuts (30), bolts (31), washers (32), bolts with captive washers (33), and tow hooks (34) from the frame (29).

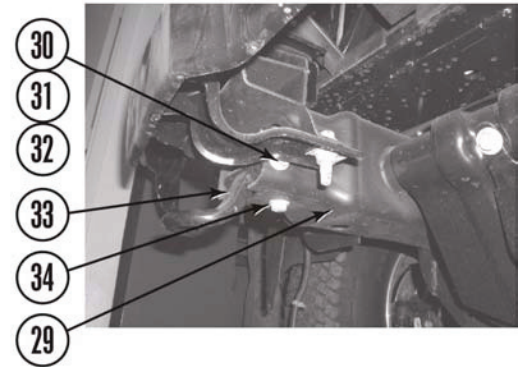
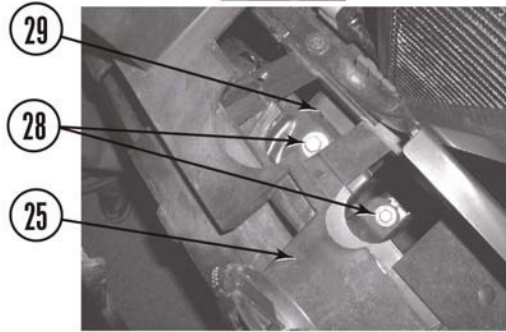
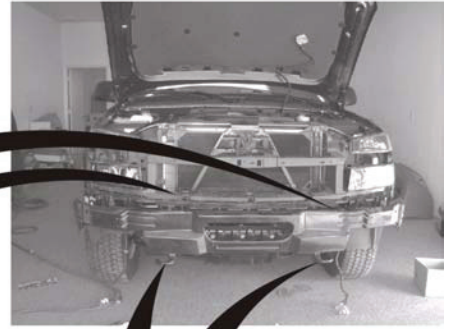

2. Under the hood.

a. Remove two hoses (35 and 36) from three clamps (37, 38 and 39).

b. Loosen two clamps (40 and 41) and remove air duct (42) from air filter housing (43) and throttle body (44).

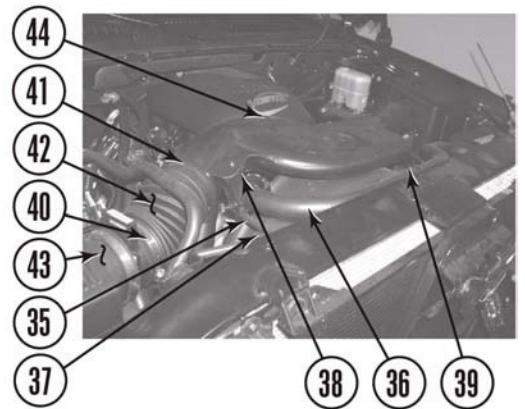

c. Remove two bolts with captive washers (45), four popups (46), and top fan shroud (47) from bottom fan shroud (48) and radiator (49) and vehicle. Rest fan shroud on fan.

d. Pull front of bottom fan shroud (48) up over core support (24), gently push lower fan blades back toward engine (if the fan is composite fiber) and remove lower fan shroud from vehicle. If the fan is hard fiber, remove lower fan shroud by turning shroud around passenger side of fan.

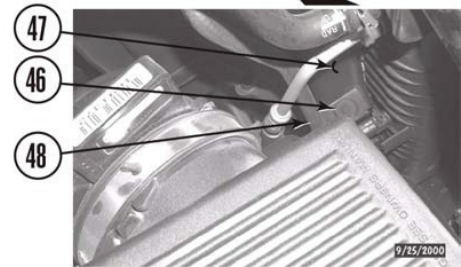
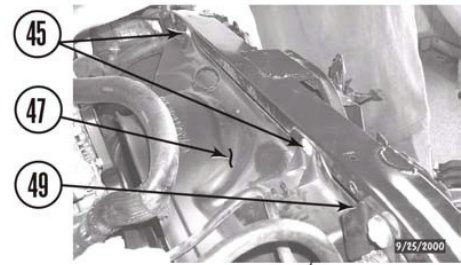

**⚠NOTE**

Ensure steering shaft does not turn independently of the steering gearbox. This could cause the air bag system to malfunction, resulting in serious personal injury or damage to the equipment.

e. Straighten steering wheel and strap the wheel so it will not turn.

f. Remove bolt (50) and clip (51) and slide upper steering shaft (52) up to separate from lower shaft (53).

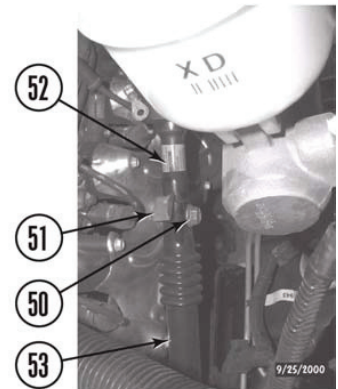

g. Remove nut (54) and ground strap (55) from stud (56).

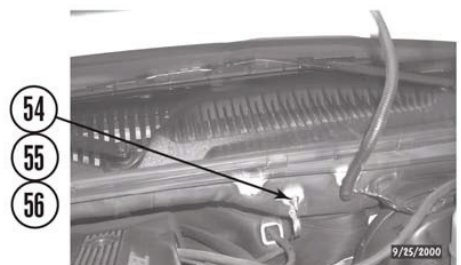

h. Remove clip (57) from bracket (58).

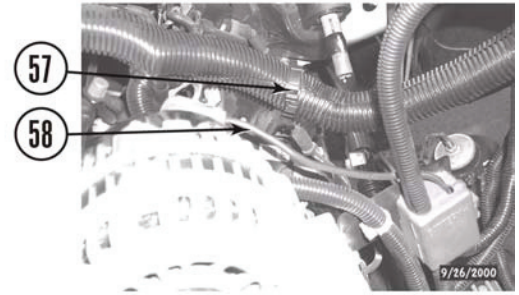

3. Along the frame rails.

a. Remove clip (59) from frame (29) driver side.  
Remove harness (60) from clip.

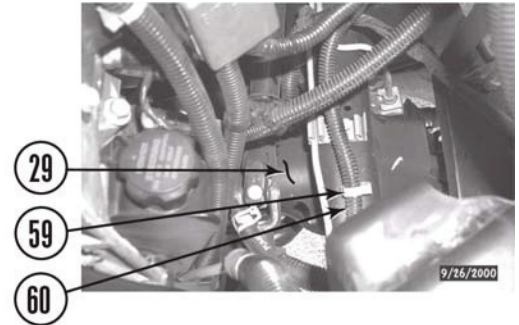

b. Remove three clips (61, 62, and 63) from frame (29) driver side and wheel well (64).

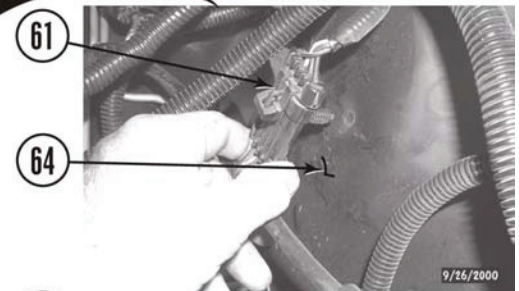
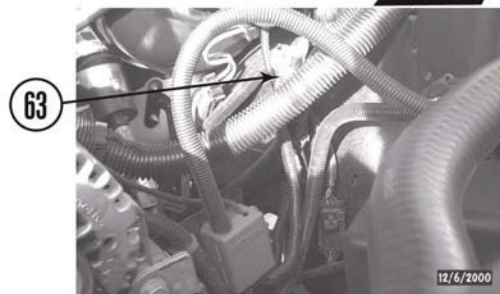

c. Remove two brake lines (65) from two sets of clips (66).

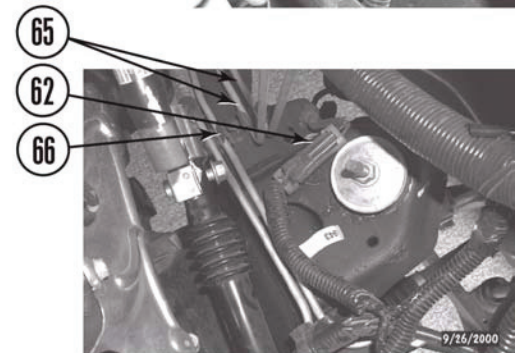



d. Remove harness (60) from clip (67).

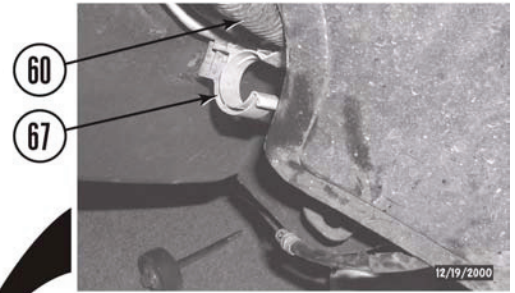

e. Remove (you may have to cut) clip (68) from frame (29).

f. Remove bolt (69) and two ground wires (70 and 71) from driver side frame mounting pad (72).

g. Remove two harnesses (60 and 73) from clip (74). Remove clip from frame (18) driver side.

h. Pull some slack in front parking brake cable (75) and clamp cable with a vicegrip.

i. Separate front part of parking brake cable (75) from rear parking brake cable (76).

j. Remove front part of parking brake cable (75) from driver side frame mounting pad (72).

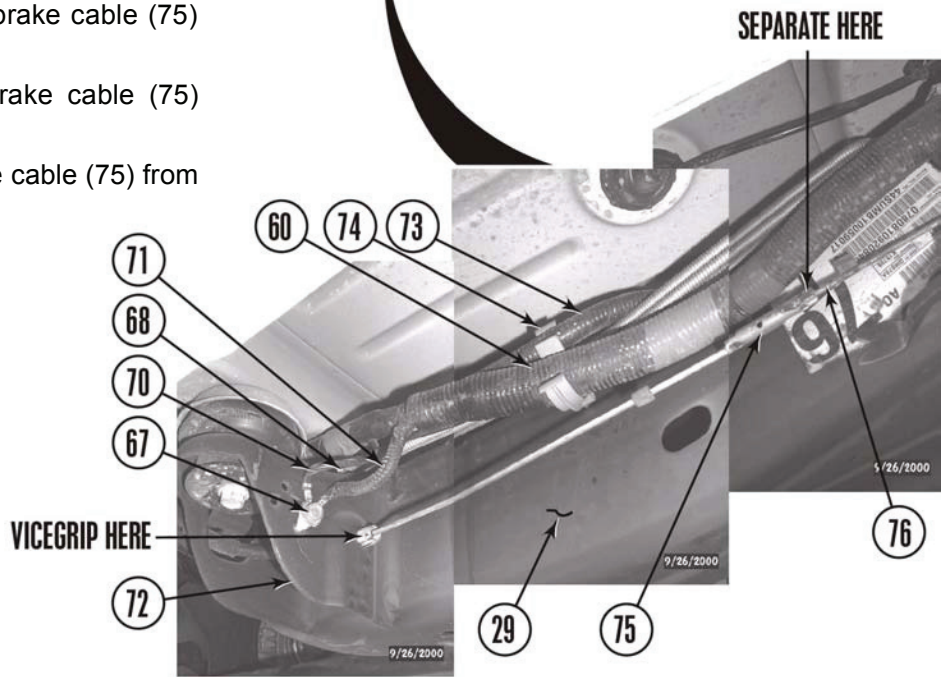

k. Remove two clips (77) and harness (78) from frame (29) passenger side.

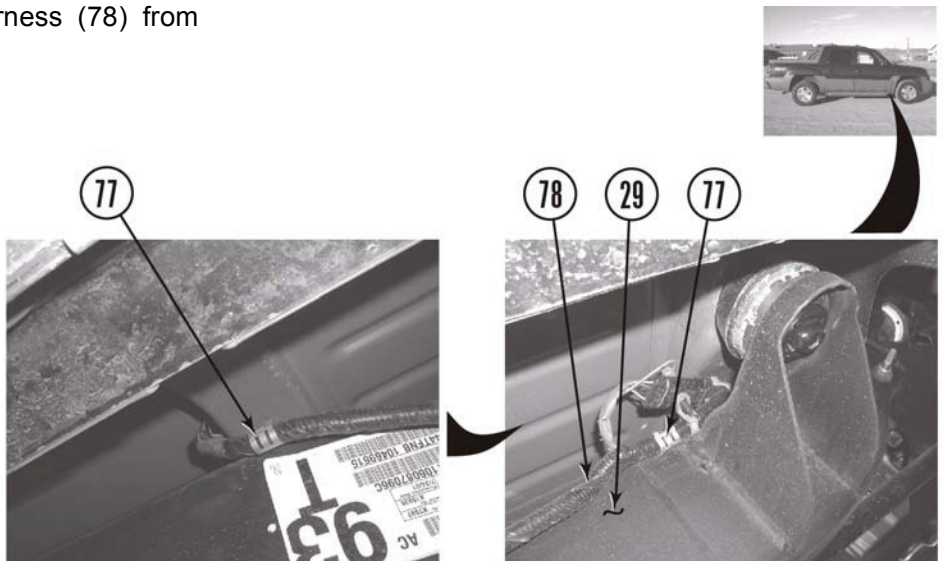



**⚠WARNING**

Use extreme caution when working near fuel lines and fuel tank. Clean up spilled fuel immediately. Any spark could cause an explosion or fire resulting in serious personal injury and property damage.

4. Remove the fuel filler.

- a. Remove gas cap (79).
- b. Remove three bolts (80) from body (81) and fuel filler (82).

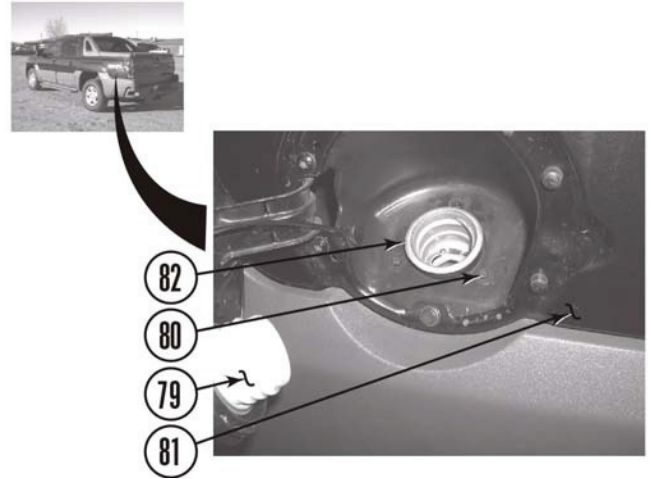

5. Remove the rear bumper.

- a. Measure distance between rear bumper (83) and tailgate (84).
- b. Remove spare tire (refer to the Owner's Manual).

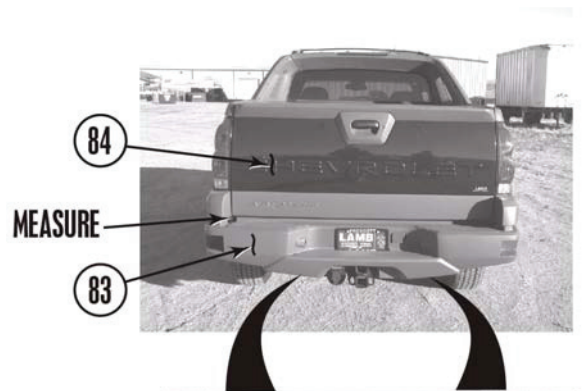

c. Disconnect two license plate lights (85) from rear bumper (83).



d. Remove three clips (86) and harness (87) from rear bumper (83).

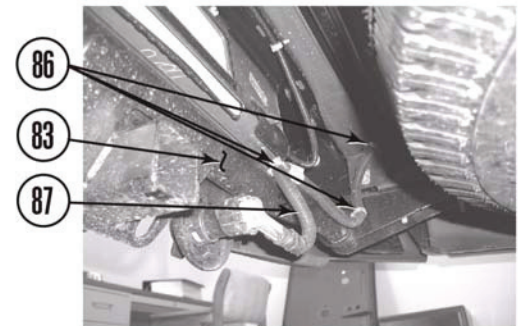

e. Remove six bolts with captive washers (88) from two rear bumper brackets (89) and frame (29).

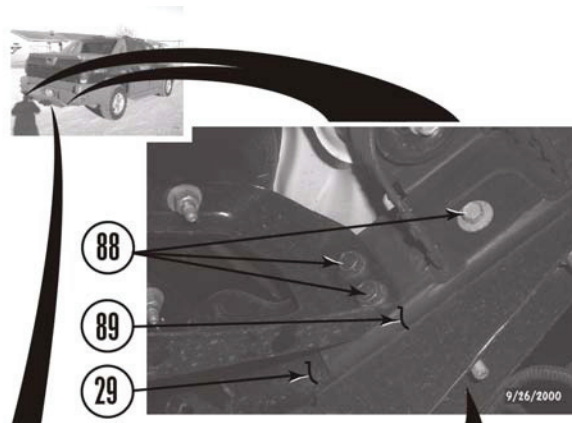

f. If equipped with a factory class III trailer hitch (90), remove four bolts (91) and hitch from frame (29).

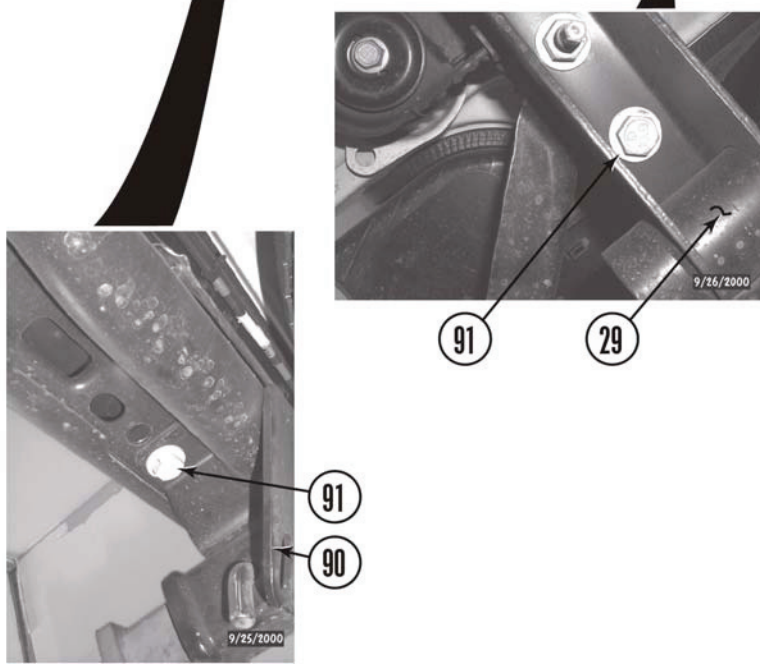

g. Remove two rear bumper brackets (89) and rear bumper (83) from frame (29).

h. Remove four nuts with captive washers (92), four bolts with captive washers (93), and two rear bumper brackets (89) from rear bumper (83).

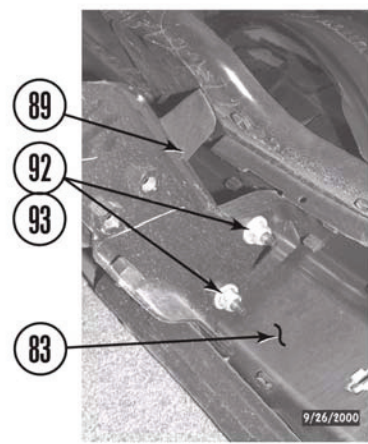

## C. Install the kit.

1. Prepare to lift body from frame.

### ⚠WARNING

Failure to replace the OEM body mounting hardware (except mounting bolts in the kit) in the stock locations could result in serious personal injury or damage to the vehicle.

- a. Hold two core support bolts (94) and loosen but do not remove two nuts (95) from core support mounting pads (17).
- b. Loosen but do not remove ten body mounting bolts (94).

### ⚠WARNING

Use extreme caution when lifting body from frame. Ensure lifting device is securely placed. Keep hands out from between frame and body, or serious personal injury could result.

### ⚠CAUTION

Continually check hoses, wires, lines, etc. to be sure that everything is flexing properly and not binding, or damage to the vehicle could result. Be especially careful of the a/c hoses at the firewall, the belt pulley, and at the core support. Ensure brake lines stretch while lifting. Bending the lines to gain ample slack may be necessary. Be extremely careful not to kink the lines.

### ⚠NOTE

Ensure stock spacers and body mounting pads stay on vehicle unless otherwise specified in these instructions. Kit spacer blocks are installed in addition to the stock spacers and body mounting pads.

### ⚠NOTE

Passenger side core support bolt can be removed but driver side core support bolt cannot until body is lifted.

- c. Remove nut (95), washer (96), bottom bushing (97), washer (98), and bolt (94) from the passenger side core support mounting pad (17) and passenger side frame mounting pad (72).

- d. Remove five bolts (94) and bottom bushings (97) from the passenger side frame mounting pads (72) and body mounting pads (99).

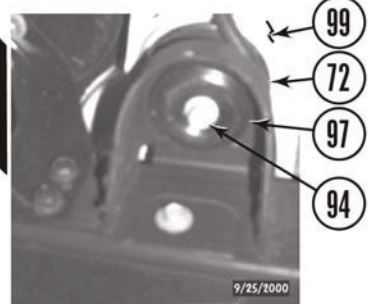
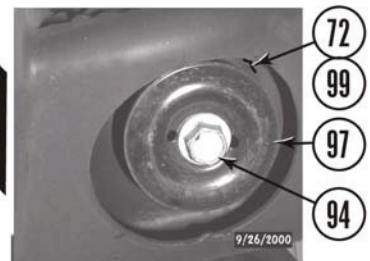
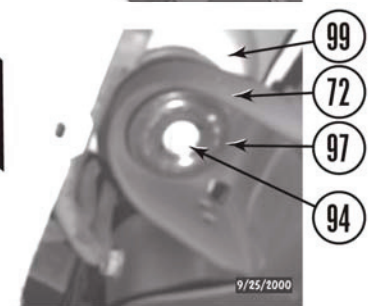
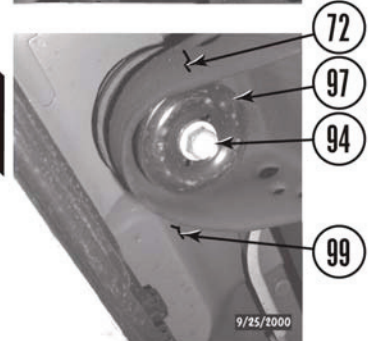
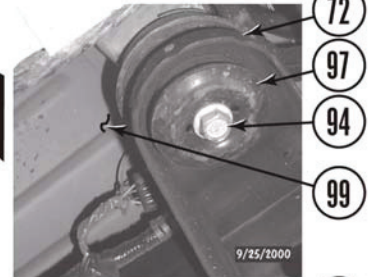
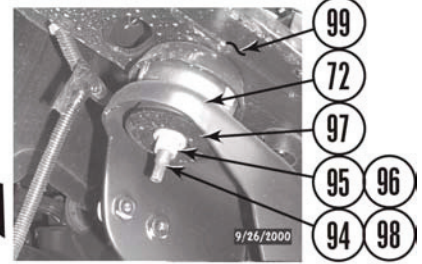



2. Lift body and install body passenger side spacer blocks.

a. Using a hydraulic jack and a wooden block, slowly lift the body (81) passenger side just high enough to position a *kit* spacer block (100) between the metal cup (101) and the passenger side core support mounting pad (17).

b. Position five *kit* spacer blocks (100) on top of the passenger side frame mounting pads (72).

c. Install a *kit* 12mm x 1.75 x 180mm bolt (102) through *kit* 7/16" USS washer (103), bottom bushing (97), frame mounting pad (72), top bushing (104), metal cup (101), *kit* spacer block (100), body passenger side core support mounting pad (17), *kit* 1/2" thick washer (105), and stock nut (95). LEAVE THE BOTTOM BUSHING (97) OFF FOR NOW. Do not tighten.

d. Install five *kit* 12mm x 1.75 x 180mm bolts (102) through five *kit* 7/16" USS washers (103), bottom bushings (97), frame mounting pads (72), top bushings (104), metal cups (101), *kit* spacer blocks (100), and body mounting pads (99). LEAVE THE BOTTOM BUSHINGS (97) OFF FOR NOW. Do not tighten.

e. Lower body (81) on the *kit* spacer blocks (100).

3. Install the body driver's side spacer blocks.

a. Repeat steps C. 1. c. and d. and C. 2. a. through e. for the body driver's side.

4. Finish the body spacer block installation.

a. Remove twelve bolts (102) one at a time, INSTALL THROUGH THE BOTTOM BUSHING (97) NOW, coat threads with Loctite®, and reinstall. Tighten to 55 lb-ft.

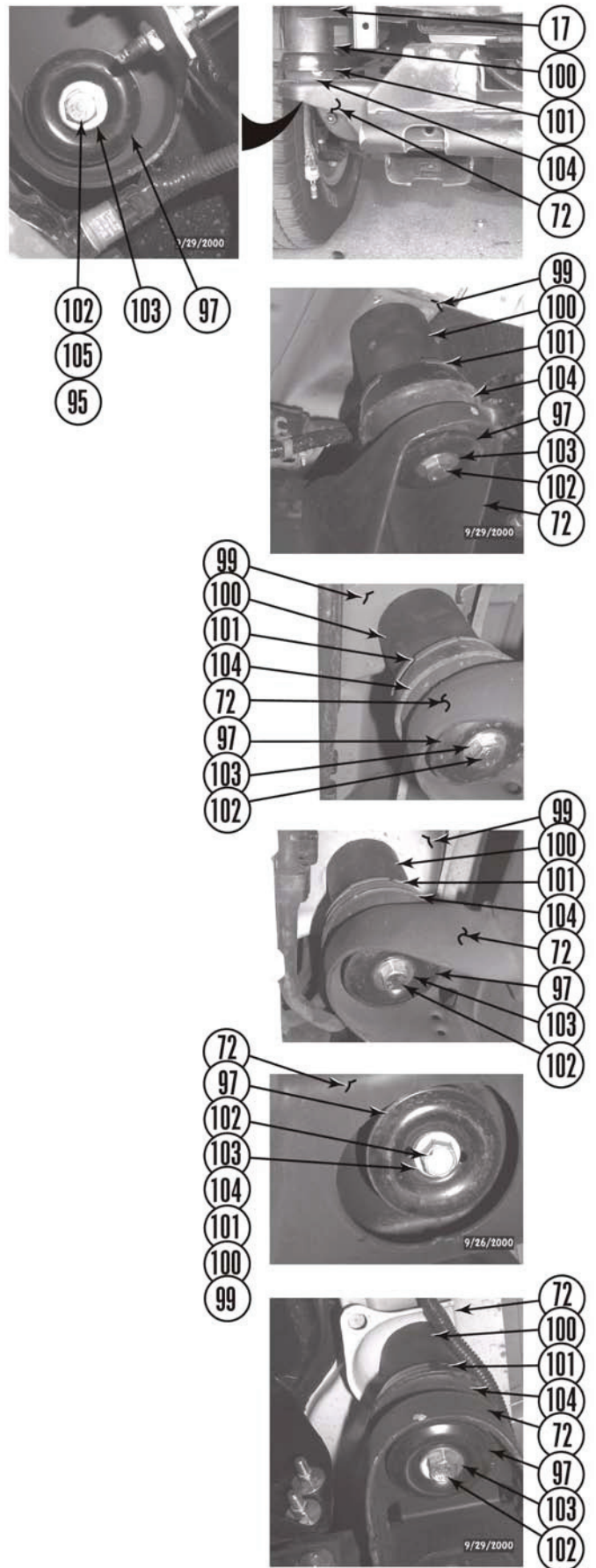

**⚠WARNING**

Use extreme caution when working near fuel lines and fuel tank. Clean up spilled fuel immediately. Any spark could cause an explosion or fire resulting in serious personal injury and property damage.

5. Install fuel filler.

- a. Install fuel filler (82) on the body (81) with three bolts (80).
- b. Install gas cap (79).



6. Along the frame rails.

- a. Install two clips (77) and harness (78) on frame (29) passenger side.

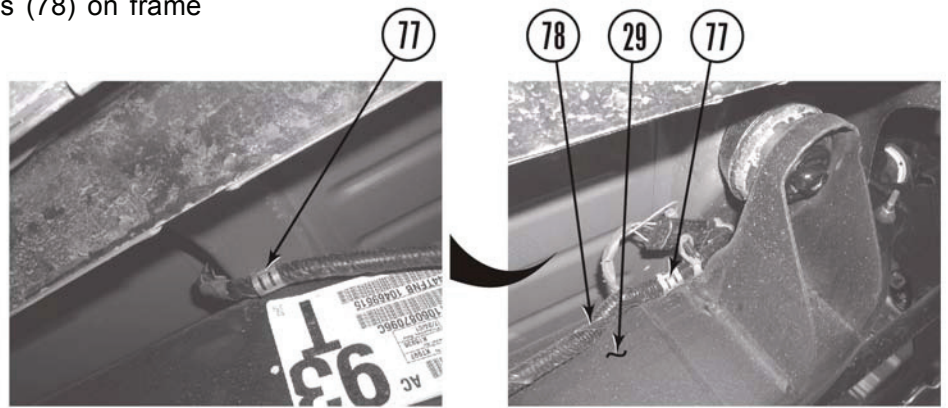

- b. Install two harnesses (60 and 73) in clip (74) and clip on frame (29) driver side.

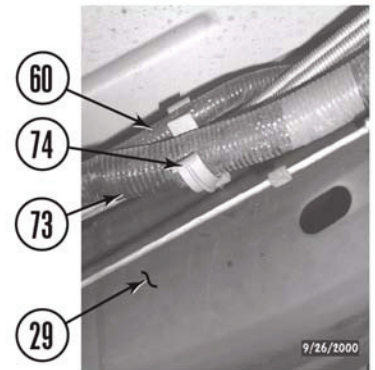

- c. Install *kit* parking brake bracket (106) on frame driver side mounting pad (72) as shown with *kit* 5/16" x 1" bolt (107), two *kit* 5/16" USS washers (108), and *kit* 5/16" nylock nut (109).

- d. Using *kit* bracket (106) as a template, drill a 5/16" hole as shown for the second *kit* bolt (107).

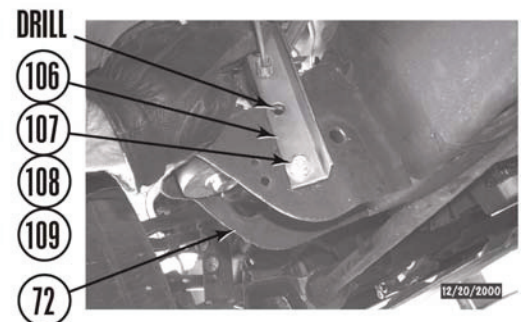



e. Install *kit* parking brake bracket (106) on frame mounting pad (72) as shown with second *kit* 5/16" x 1" bolt (107), two *kit* 5/16" USS washers (108), and *kit* 5/16" nylock nut (109).

f. Install two ground wires (69 and 70) on *kit* parking brake bracket (106) with *kit* 5/16" x 1" bolt (107), two *kit* 5/16" USS washers (108), and *kit* 5/16" nylock nut (109).

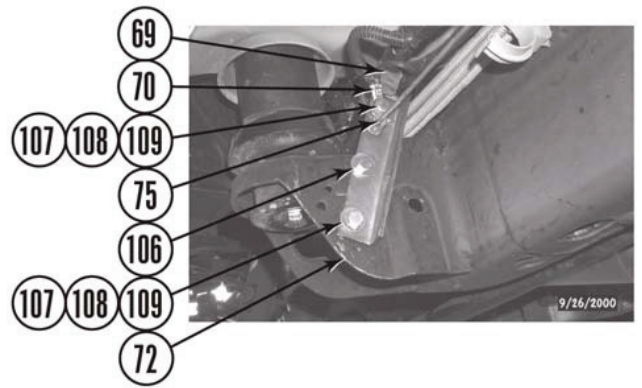

g. Route the front parking brake cable (75) through the biggest hole in the *kit* parking brake bracket (106) and reconnect the front cable to the rear cable (76).

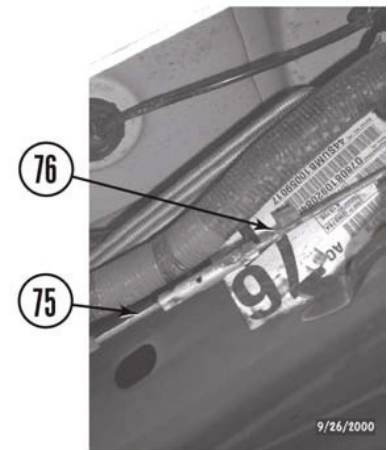

h. Install two brake lines (65) in two sets of clips (66).

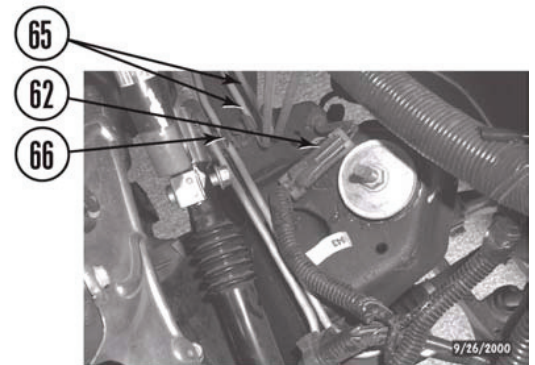

i. If possible, install three clips (61, 62, and 63) in frame (29) driver side and wheel well (64).

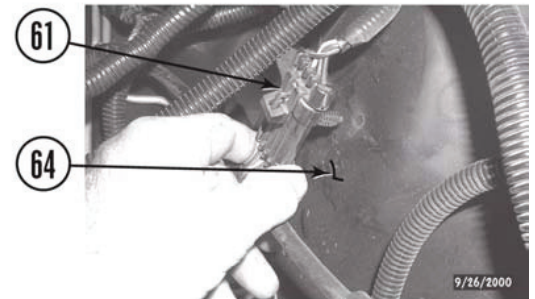
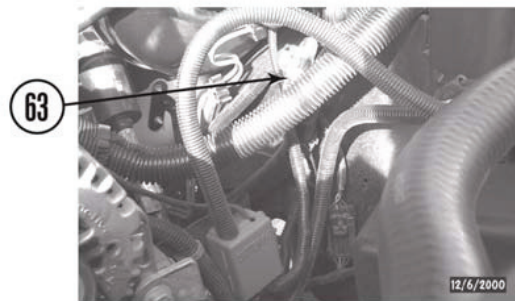

j. If possible, install harness (60) in clip (59) and clip in frame (29) driver side.

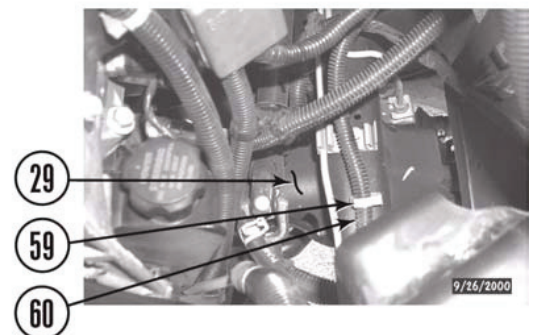



k. If possible, install clip (57) in bracket (58).

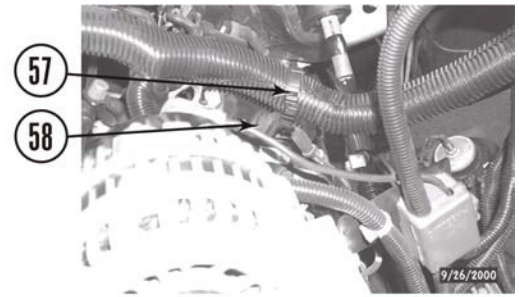

7. Under the body.

**NOTE**

Step 7.a. is for vehicles with automatic transmissions only. Other models skip this step.

a. Ensure automatic transmission cable (110) has enough slack and is not pulling on boot (111) or binding. If cable is pulling or binding, remove cable from clip (112).

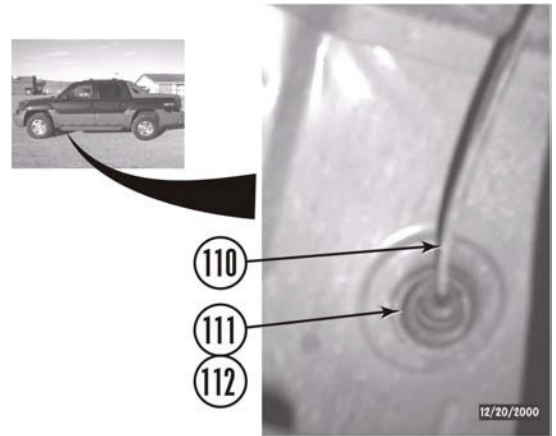

8. Under the hood.

a. Install *kit* bracket (113) on stud (56) with nut (54).  
b. Install ground strap (55) on *kit* bracket (113) with *kit* 1/4" x 1" bolt (114), two *kit* 1/4" SAE washers (115), and *kit* 1/4" nylock nut (116).

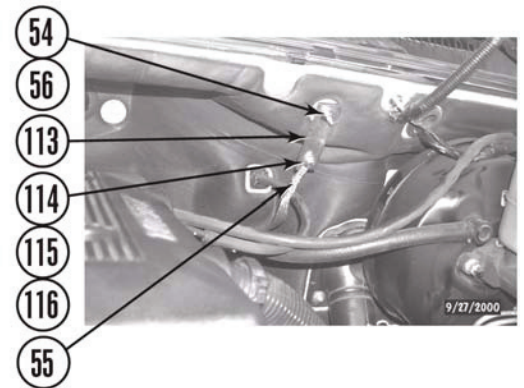

9. Install *kit* steering extension.

a. Coat threads of retaining bolts (50 and 117) with Loctite®.  
b. Install *kit* steering extension (118) on upper steering shaft (52) with *kit* 3/8" x 1 3/4" retaining bolt (117), two *kit* 3/8" SAE washers (119), and *kit* 3/8" nylock nut (120). Do not tighten.  
c. Install lower steering shaft (53) on *kit* steering extension (118) with the stock retaining bolt (50) and clip (51).  
d. Tighten bolts (50 and 117) to 33 lb-ft.

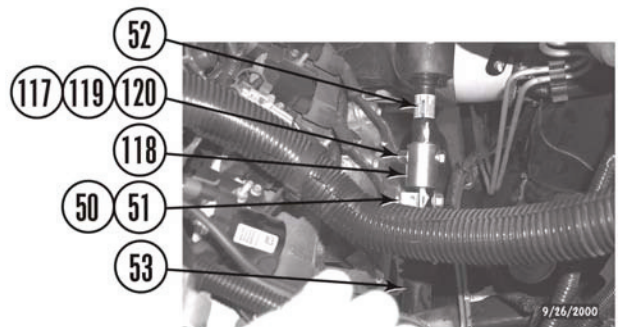

10. Radiator.

a. Trim ears from bottom fan shroud (48) as shown.

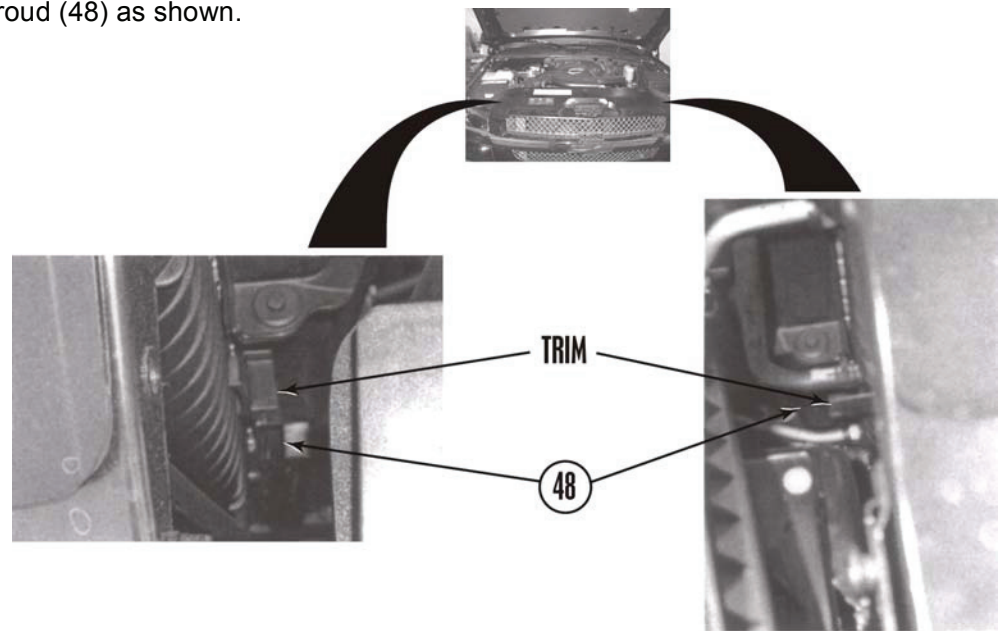

b. Remove two center harness clips (121) from core support (24). Remove two clips from harness (122).

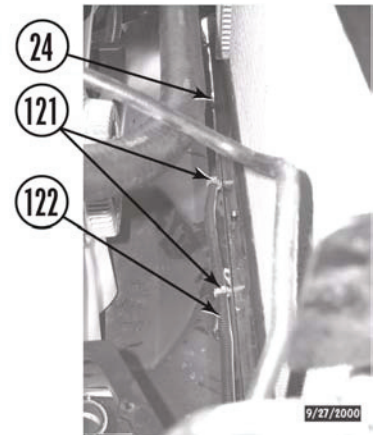

c. Position two *kit* clamps (123) on harness (122).

d. Install two *kit* clamps (123) and two *kit* lower fan shroud mounting brackets (124) on the core support (24) with two *kit* 1/4" x 1" bolts (125), two *kit* 1/4" SAE washers (126), and two *kit* 1/4" nylock nuts (127).

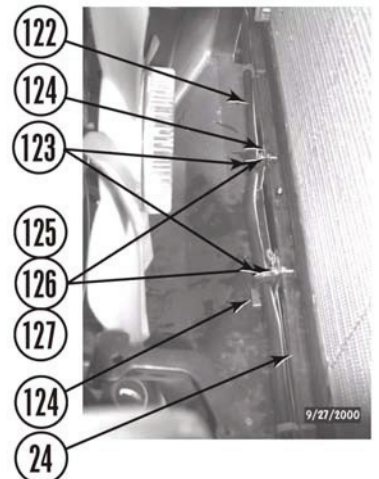

e. Install two *kit* upper fan shroud mounting brackets (128) on core support (24) with two bolts with captive washers (45). Do not tighten.

f. Install top fan shroud (47) on *kit* mounting brackets (128) with two *kit* 1/4" SAE washers (126) and *kit* 1/4" nylock nuts (127). Do not tighten.

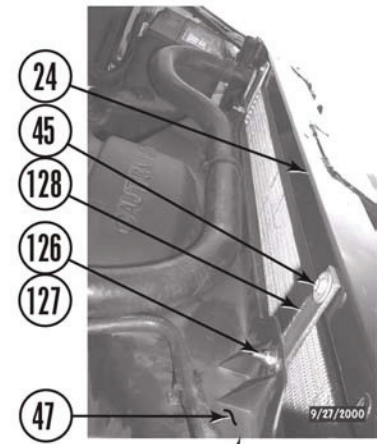

g. Install top fan shroud (47) on bottom fan shroud (48) with four popups (46).

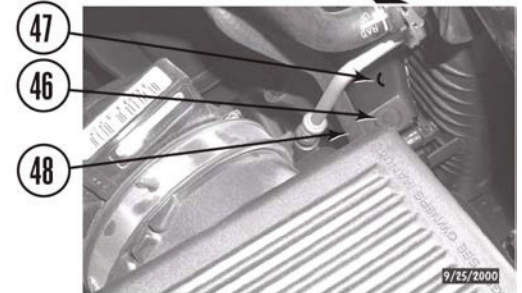

h. Using two *kit* lower fan shroud support brackets (124) as a template, mark and drill two 5/16" holes in the bottom fan shroud (48) from front of vehicle up through shroud as shown.

i. Install bottom fan shroud (48) on two *kit* lower fan shroud support brackets (124) with two *kit* 1/4 x 1" bolts (125), four *kit* 1/4" SAE washers (126), and two *kit* 1/4" nylock nuts (127). Ensure bolt threads point out of shroud.

j. Check fan to fan shroud clearance. Ensure gap is the same all around shroud and tighten bolts (125) and nuts (127).

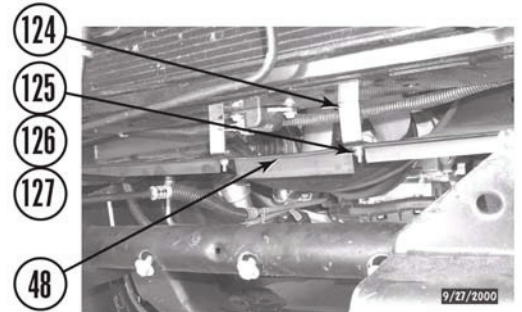

k. Position air duct (42) on air filter housing (43) and throttle body (44) and tighten two clamps (40 and 41).

l. Install two hoses (35 and 36) in three clamps (37, 38, and 39).

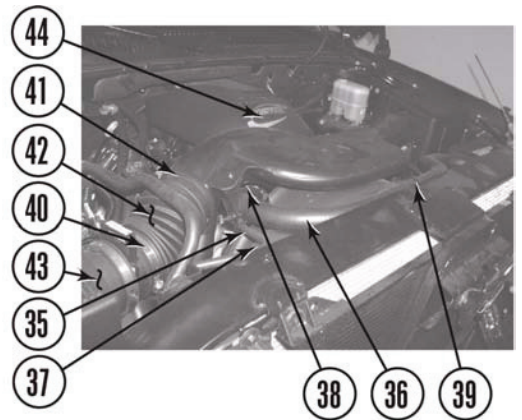



11. Install the front bumper.

a. Trim the two front frame crush zones (129) as shown.

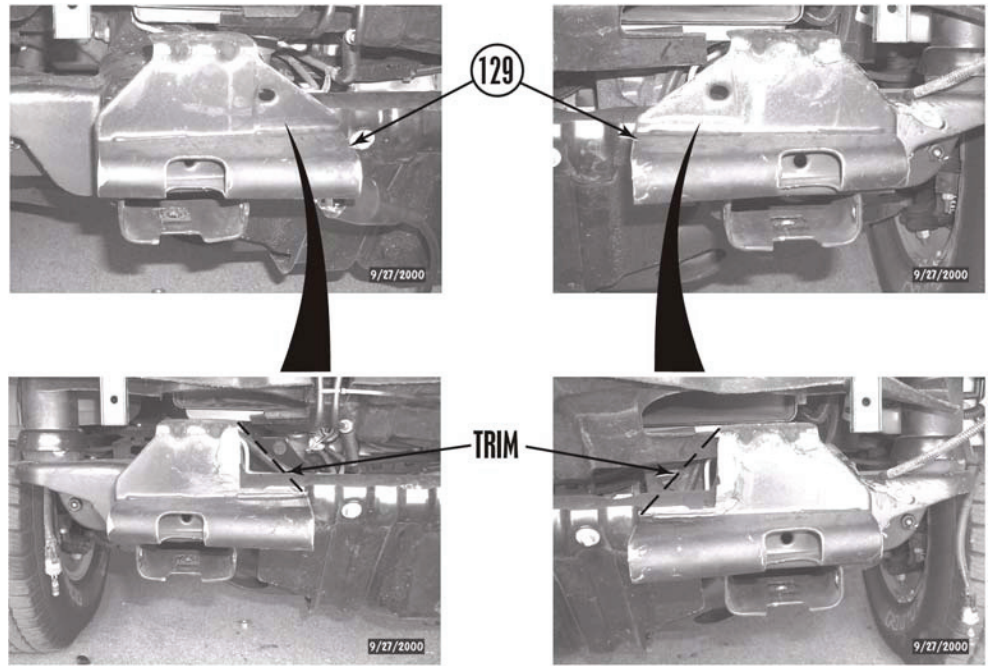

b. Trim the core support (24) in four places as shown.

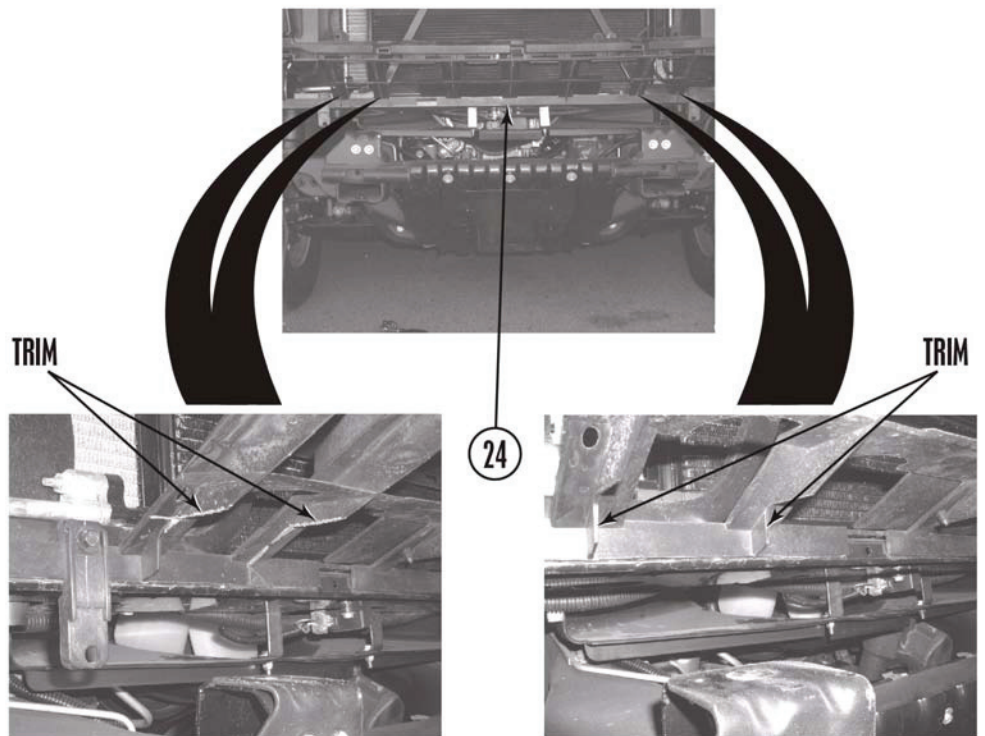

c. Coat threads of bolts (28 and 131) and nuts (133) with Loctite®.

d. Install two *kit* bumper brackets (130) on frame (29) with two stock bolts with captive washers (28), two *kit* 7/16" x 1 1/2" bolts (131), four *kit* 7/16" USS washers (132), and two *kit* 7/16" nylock nuts (133). Do not tighten.

e. Install *kit* small bumper brackets (134) on *kit* bumper brackets (130) with four *kit* 7/16" x 1 1/2" bolts (131), eight *kit* 7/16" USS washers (132), and four *kit* 7/16" nylock nuts (133). Do not tighten.

f. Install front inner bumper (25) on two *kit* bumper brackets (130) and two *kit* small bumper brackets (134) with two stock bolts with captive washers (28), two *kit* 7/16" x 1 1/2" bolts (131), four *kit* 7/16" USS washers (132), and two *kit* 7/16" nylock nuts (134).

g. Tighten nuts (133) and bolts (28 and 131).



25

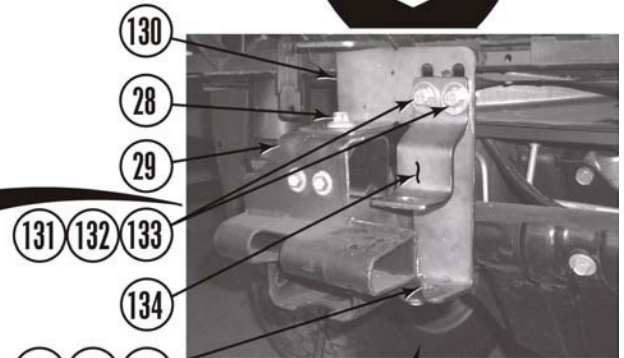

130

28

29

131 132 133

134

131 132 133

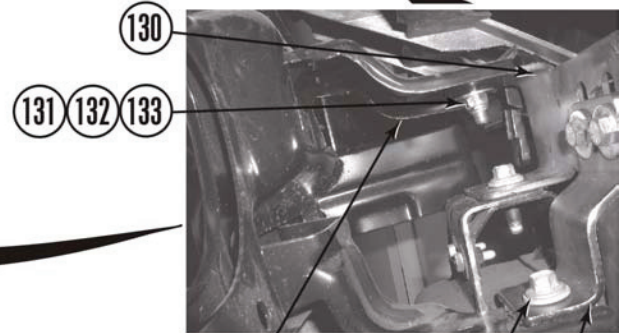

130

131 132 133

25

28

134

h. Position grille (8) on front of vehicle, click two clips (27) into two front fenders (11), and two more clips (26) into core support (24).

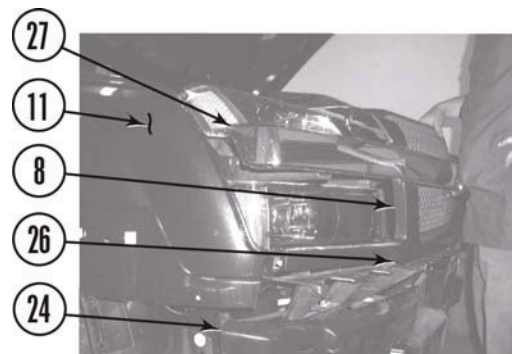

27

11

8

26

24

i. Position front outer bumper (10) over front inner bumper (25) and click fourteen clips (23) into two front fenders (11), core support (24), front inner bumper (25), and grille (8).

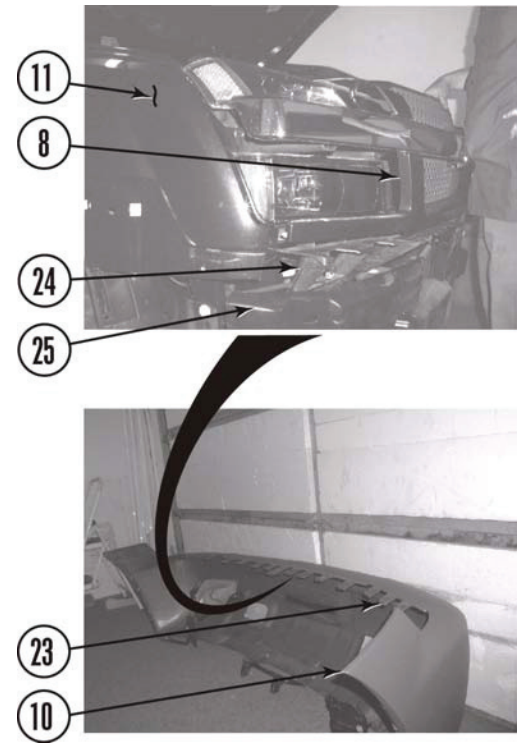

j. Click four clips (22) into two front fenders (11).

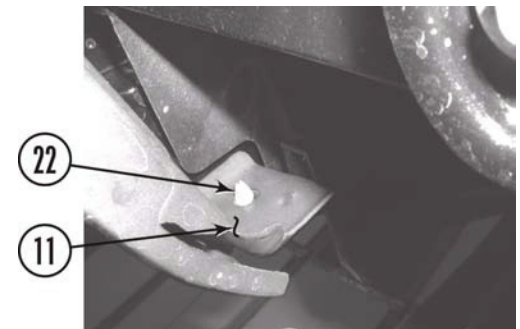

k. Install four connectors (20) in two fog lamps (21) and four push clips (18) in bumper brackets (19).

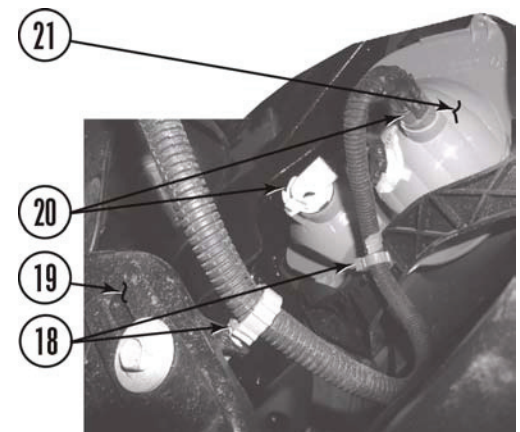



l. Install two side brackets (16) on frame (29) with four bolts (15) (note that bolts now go in bracket center holes).

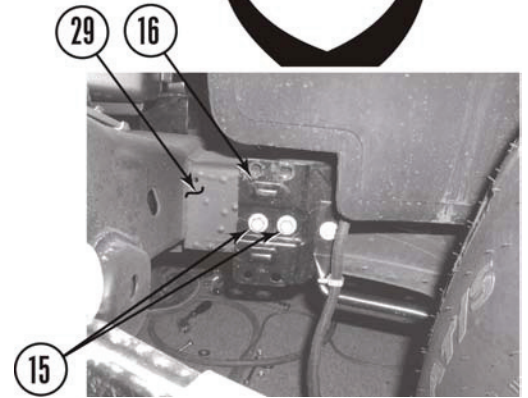

m. Install bracket (13) on shroud (14) with two bolts with captive washers (12).



n. Install front outer bumper (10) on two front fenders (11) with eight screws (9).

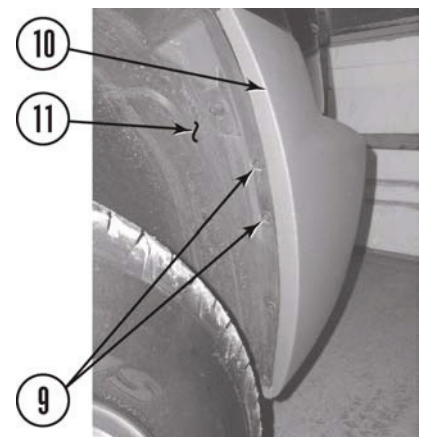

- o. Install three popups (7) in grille (8).
- p. Check measurements between front bumper (15) and front fenders (14). Adjust bumper to body clearance and tighten bolts and nuts to 55 lb-ft.

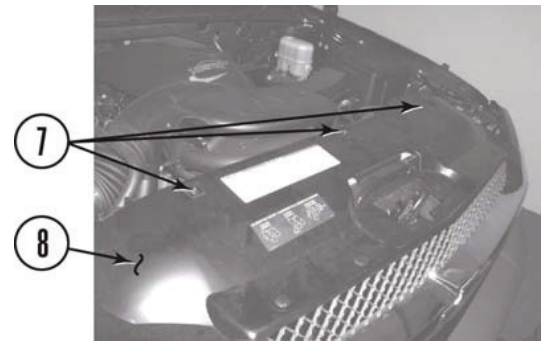

**⚠WARNING**  
 The following procedure is intended only to enhance the appearance of the vehicle. The rear bumper will no longer be rated for towing of any kind. Towing with the rear bumper after it has been lifted can result in death, serious personal injury, or damage to the vehicle. Towing after the bumper has been lifted should be accomplished using a rated Class III receiver type hitch.

12. Install the rear bumper.

- a. Trim spare tire carrier (135) as shown.



- b. Remove tailgate (84) from bed (81).
- c. Remove two screws (136) from molding (137) and bed (81).

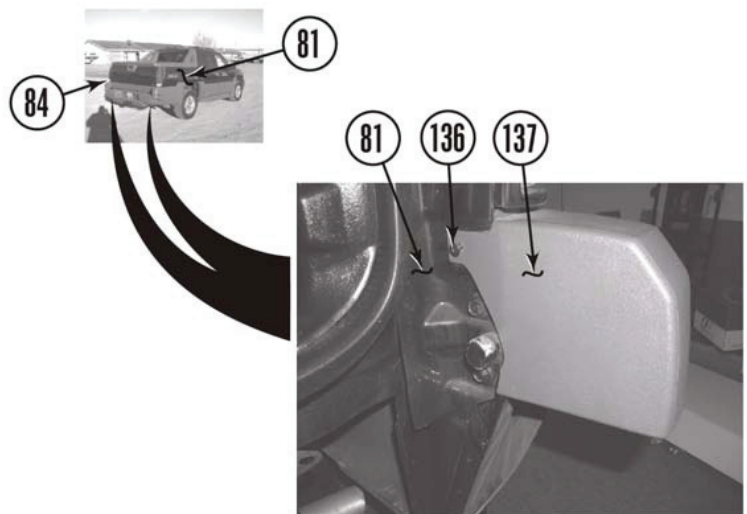

d. Coat threads of bolts (91, 93, 131, and 138) and nuts (92, 133, 140, and 146) with Loctite®.

e. Position two *kit* rear bumper brackets (137) in frame (29) rails and install four *kit* 7/16 x 1 1/2" bolts (131), eight *kit* 7/16" USS washers (132), four *kit* 7/16" nylock nuts (133), two *kit* 3/8" x 1 1/2" bolts (138), four *kit* 3/8" USS washers (139), and two *kit* 3/8" nylock nuts (140). Do not tighten.

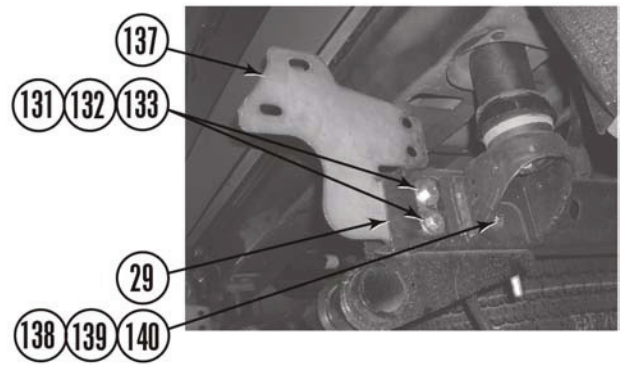

f. Tilt back of rear bumper (83) up and install on two *kit* rear bumper brackets (137) with four bolts with captive washers (93), nuts with captive washers (92), four *kit* 7/16 x 1 1/2" bolts (131), eight *kit* 7/16" USS washers (132), four *kit* 7/16" nylock nuts (133). Do not tighten. Ensure spare tire crank shaft (141) on rear bumper slides over shaft (142) from spare tire. If rear bumper does not install, or does not align with kit bumper brackets, loosen nut (143) and bolt (144) and try again, then tighten nut and bolt.

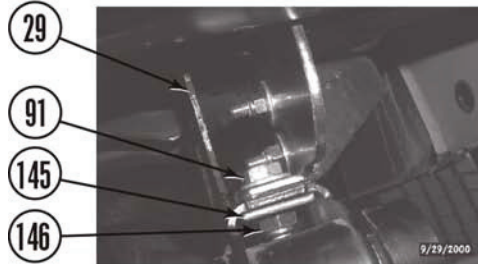
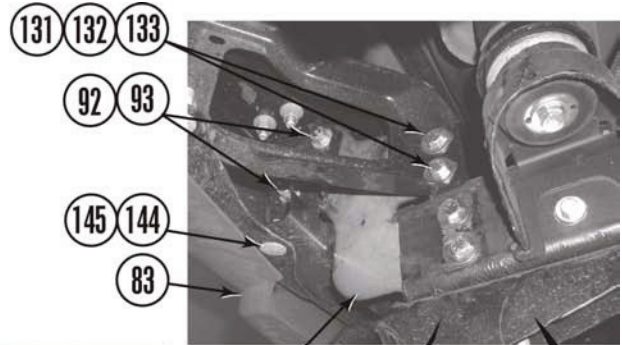

g. If equipped with a trailer hitch (90), install hitch on frame (29) with four bolts (91), two *kit* square washers (145), and two *kit* 14mm nylock nuts (146).

h. Install C-bracket (147) between rear bumper (83) and hitch with two bolts (91), two *kit* 7/16 x 1 1/2" bolts (131), four *kit* 1/2" USS thick washers (148), and four *kit* 7/16" nylock nuts (133).

i. Install screws (136), adjust bumper to body clearance and tighten bolts (91, 93, 131, and 138) and nuts (92, 133, 140, and 146) to 55 lb-ft. Install screws (136)

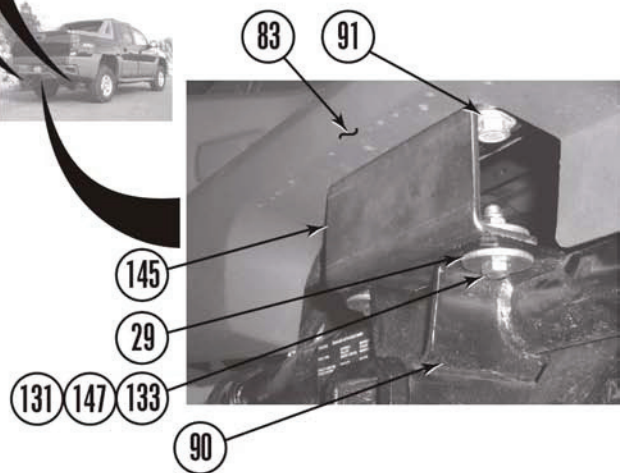



j. Install three clips (86) and harness (87) in rear bumper (83).

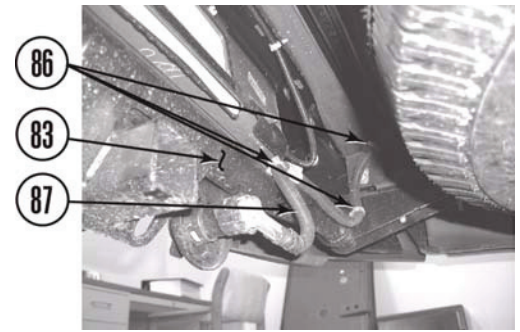

k. Connect two license plate lights (85) in rear bumper (83).

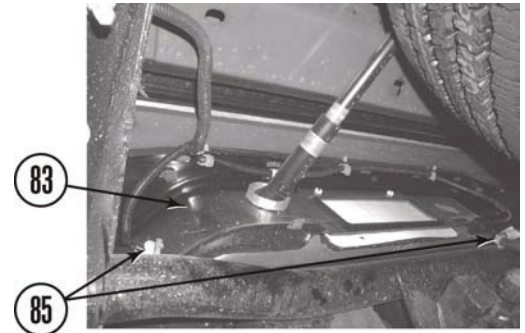

**D. After installation is complete.**

1. Install airbag fuse (5) in fuse panel (6). Install cover (4).

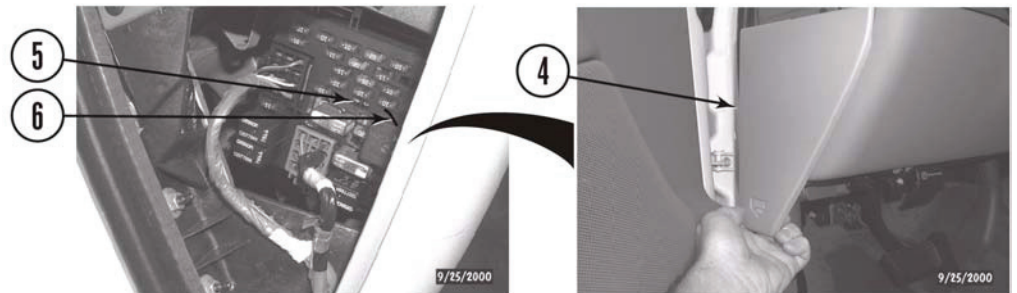

2. Connect both battery cables to the battery (3). Be sure to reconnect the positive cable (2) first, then the negative cable (1).

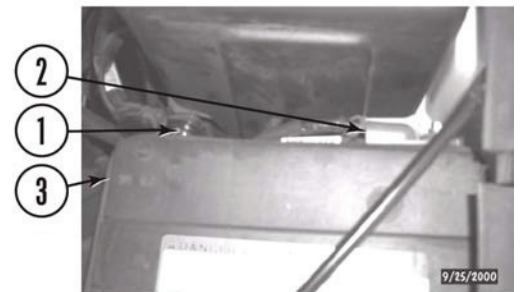

3. Install Gap Guards™ in front and rear wheel wells (you did order your gap guards, didn't you?).

4. Stick *kit* warning sticker on the dash in plain sight of all vehicle occupants.

5. Double check the vehicle.

**⚠CAUTION**

Retorque all fasteners after 500 miles and after off road use. All body lift components should be visually inspected and fasteners retorqued during routine vehicle servicing.

- a. Check all mounting hardware to ensure it is properly tightened.
- b. Check all wires, hoses, cables, etc. to ensure they have been properly connected and there is ample slack. With the number of hoses on this vehicle, it is vital that this be checked thoroughly.

- c. Check vehicle electrical system.
- d. Start vehicle and check the steering in both directions to ensure that there is no bind. Check clutch operation. Check the operation of the brake system and the parking brake. Check both shift levers' operation. Ensure that there is proper engagement in all gears and 4 wheel drive ranges.

**⚠CAUTION**

Never open a closed cooling system after the vehicle has been started. Only fill the cooling system if the cap has been removed while the vehicle was still cold.

- e. Check coolant level. Fill coolant to the proper level (refer to the Owner's Manual).
- f. Test drive vehicle in all gears and 4 wheel drive ranges. Pay close attention to all vehicle systems. Check all hardware again in 500 miles and as part of your regular maintenance schedule.

**⚠CAUTION**

Performance Accessories does not recommend any particular wheel and tire combinations for use with its body lifts and cannot assume responsibility for the customer's choice of wheels and tires. Reference your owner's manual for recommended tire sizes and warnings related to the use of oversized tires. Larger wheel and tire combinations increase stress and wear on steering and suspension components, which leads to increased maintenance and higher risk for component failure. Larger wheel and tire combinations also alter speedometer calibration, braking effectiveness, center of gravity, and handling characteristics. Consult with an experienced local off road shop to find what wheel and tire combinations work best with your vehicle.

**⚠NOTE**

All warranty information, instruction sheets, and other documents regarding the installation of this product must be retained by the vehicle owner. Information contained in the instructions and on the warranty card will be required for any warranty claims. The vehicle owner needs to understand the modifications made to his vehicle and how they affect vehicle handling and performance. Failure to provide the customer with this information can result in damage to the vehicle and severe personal injury.

Rev. 6/02, Copyright 2002

## E. Kit Parts List.

Quantity	Description
	<b>Kit</b>
12	3 x 3 blocks
2	Front bumper brackets
2	Front L-shaped inner bumper brackets
2	Rear bumper brackets
1	Rear hitch bracket
1	Warning to driver sticker
1	Logo sticker
1	6ml bottle Loctite
<b>1</b>	<b>Bolt pack BP10073</b>
1	Parking brake bracket
12	12mm x 1.75 x 180mm bolts
3	5/16" x 1" bolts
16	7/16" USS washers
6	1 3/4" thick washers
6	5/16" USS washers
1	se 4500 steering extension
1	3/8" x 1 3/4" hex head bolt
3	3/8" nylock nut
3	5/16" nylock nuts
2	3/8" USS washers
<b>1</b>	<b>Hardware pack HP10073</b>
	<b>Bolts</b>
18	7/16" x 1 1/2" bolts
2	3/8" x 1 1/2" bolts
5	1/4" x 1" bolts
	<b>Washers</b>
28	7/16" USS washers
2	3/8" SAE washers
12	1/4" SAE washers
2	1 1/2" x 2 1/2" rect. washers
	<b>Nuts</b>
2	14mm nylock nuts
18	7/16" nylock nuts
7	1/4" nylock nuts
	<b>Miscellaneous</b>
1	3" ground strap
2	3" upper fan shroud bracket
2	3" 683-3 L-shaped rad brackets
2	Harness clamps (rubber clad)



Front bumper brackets (assembled)



Rear bumper bracket



Fan shroud bracket



Parking brake bracket

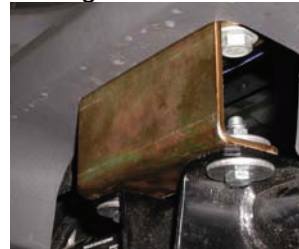

Hitch bracket