



841 S. 71st Avenue • Phoenix, AZ 85043
(623) 907-0081
www.performanceaccessories.com

**CHEVY / GMC 1500 1/2 TON
PICKUP
BODY LIFT
INSTALLATION INSTRUCTIONS**
2003-2005 2" KIT# PA10132
2003-2005 3" KIT# PA10133

⚠ WARNING
This kit should only be installed on a vehicle that is in good working condition. Before you install the kit, thoroughly inspect the vehicle for corrosion or deformation of the sheet metal around the factory body mounts. If the vehicle is suspected to have been in a collision or misused, do not install this kit. Off-road use of your vehicle with this kit installed may increase the stress applied to the factory body mounts. We do not recommend that any vehicle with a body lift kit be involved in any extreme off-road maneuvers such as jumping. Failure to observe this warning may result in serious personal injury and/or severe damage to your vehicle.

⚠ WARNING
Many states and municipalities have laws restricting bumper heights and vehicle lifts. Consult state and local laws to determine if the changes you intend to make to the vehicle comply with the law.

⚠ WARNING
The installation of larger tires may reduce the effectiveness of the braking system.

⚠ WARNING
Always wear eye protection when operating power tools.

⚠ WARNING
Before you install this kit, block the vehicle tires to prevent the vehicle from rolling.

⚠ WARNING
Accidental deployment of the air bag can result in serious personal injury or death. To avoid accidental deployment during installation of the kit, the Supplemental Restraint System (SRS, or airbag) must remain deactivated. Do not allow anyone near the airbag during installation. Refer to the factory service manual or owner's manual for the recommended procedure to disable the SRS. After you install the kit, reactivate the SRS before driving the vehicle.

⚠ NOTE
Performance Accessories recommends using the Loctite® supplied in the kit on the threads of all kit nuts and bolts unless specified otherwise in these instructions.

⚠ WARNING
Installation of a Performance Accessories body lift kit will change the vehicle's center of gravity and handling characteristics both on- and off-road. You must drive the vehicle safely! Extreme care must be taken to prevent vehicle rollover or loss of control, which could result in serious injury or death. Avoid sudden sharp turns or abrupt maneuvers and always make sure all vehicle occupants have their seat belts fastened.

⚠ WARNING
Before you install this kit, read and understand all instructions, warnings, cautions, and notes in this instruction sheet and in the vehicle owner's manual.

⚠ CAUTION
Proper installation of this kit requires knowledge of the factory recommended procedures for removal and installation of original equipment components. We recommend that the factory shop manual and any special tools needed to service your vehicle be on hand during the installation. Installation of this kit without proper knowledge of the factory recommended procedures may affect the performance of these components and the safety of the vehicle. We strongly recommend that a certified mechanic familiar with the installation of similar components install this kit.

Before Starting Installation

⚠ NOTE

Kit parts are prefaced by the word **kit** and appear in **bold** print.

1. Carefully read all warnings and instructions completely before beginning.
2. Verify all parts have been received in this kit by checking the parts list at the end of this document.

⚠ NOTE

If parts are missing from kit, please be prepared to provide the following information:

1. **Name** of purchase location
2. **Bar Code** on side of box
3. **Date** above bar code
4. **Date** inside box cover
5. **Inspector #** from inside box cover

3. **Only install this kit on the vehicle for which it is specified.** If anytime during the installation you encounter something different from what is outlined in the instructions, call technical support at (928) 636-7080.

4. Special tools needed:

- a. Welder or access to a professional welding shop.
- b. Die grinder or similar tool capable of cutting metal.

5. Park vehicle on a clean, dry, flat, level surface and block tires so vehicle cannot roll in either direction.

Engine Compartment

1. Disconnect both battery cables. Disconnect negative cable first, then positive cable.

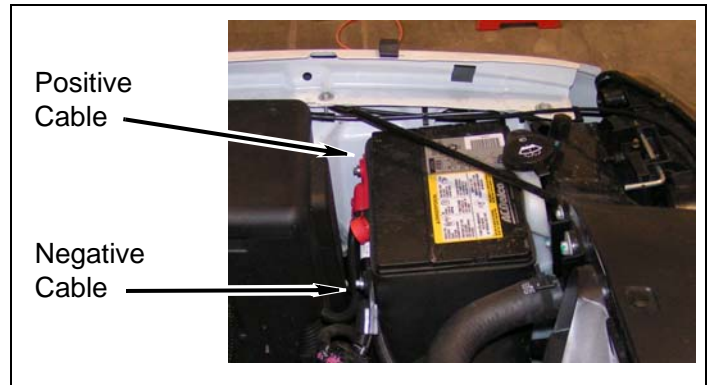

2. Airbag Fuse

⚠ NOTE

The location of the airbag fuse may vary; check the owner's manual.

- a. Remove fuse cover.
- b. Remove airbag fuse.

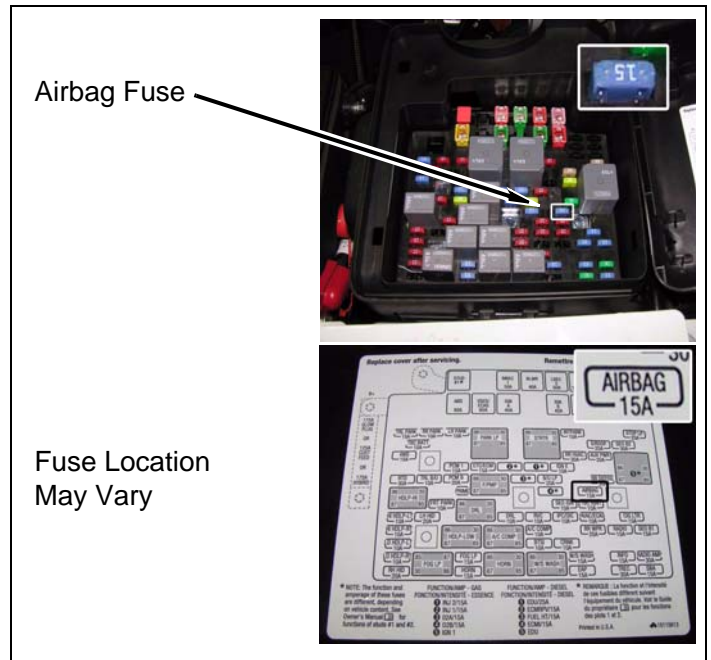

Prepare to Install Kit

Measurements

1. Measure and record distance between front bumper and fenders.

Driver Side _____ Passenger Side _____

2. Measure and record distance between rear bumper and bed.

Driver Side _____ Passenger Side _____

3. Measure and record distance between cab and bed.

Driver Side _____ Passenger Side _____

Front of Vehicle

1. Grill

- a. Remove seven panel clips and cover from core support.

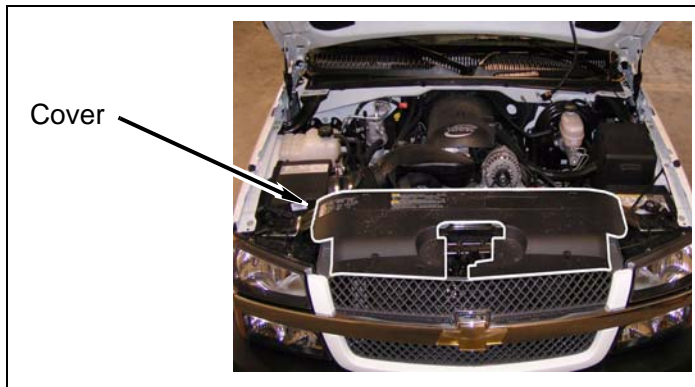

- b. Remove six clips and grill from core support and front fenders.

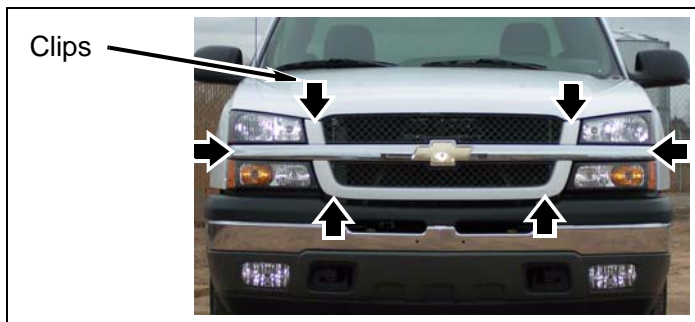

2. Front bumper

- a. Remove two wire connectors from fog lamps, if equipped.

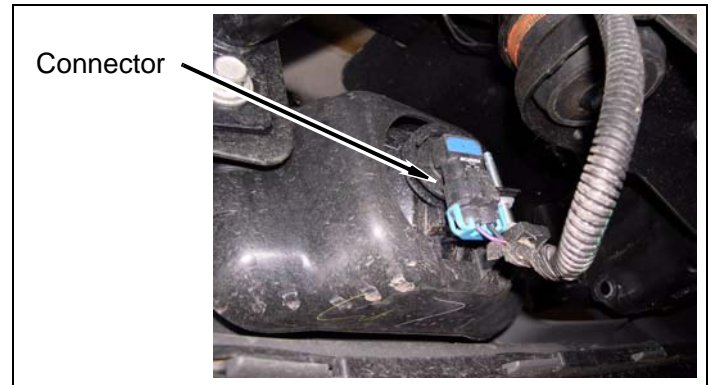

- b. Remove bolts attaching bumper and bumper brackets to frame. Remove left and right bumper support brackets.

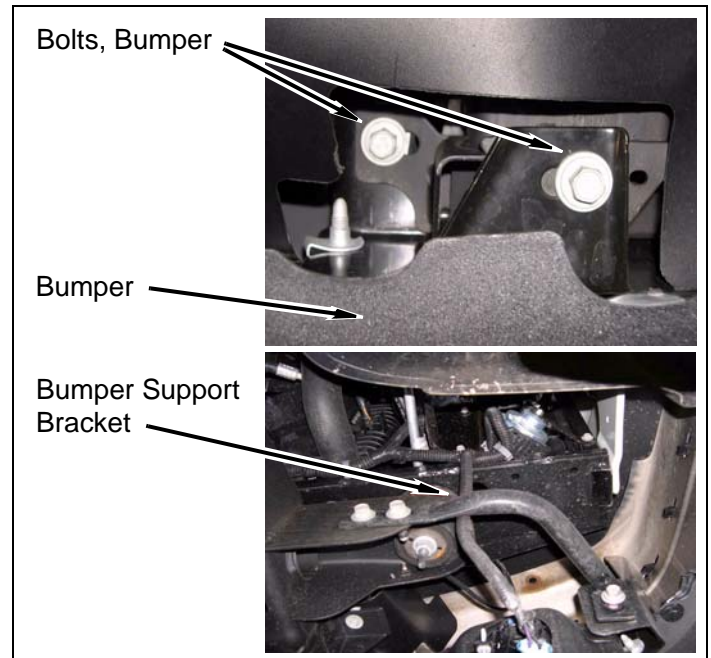

- c. Remove front bumper.

3. Tow hooks

- a. Remove bolts attaching tow hooks to frame rails.

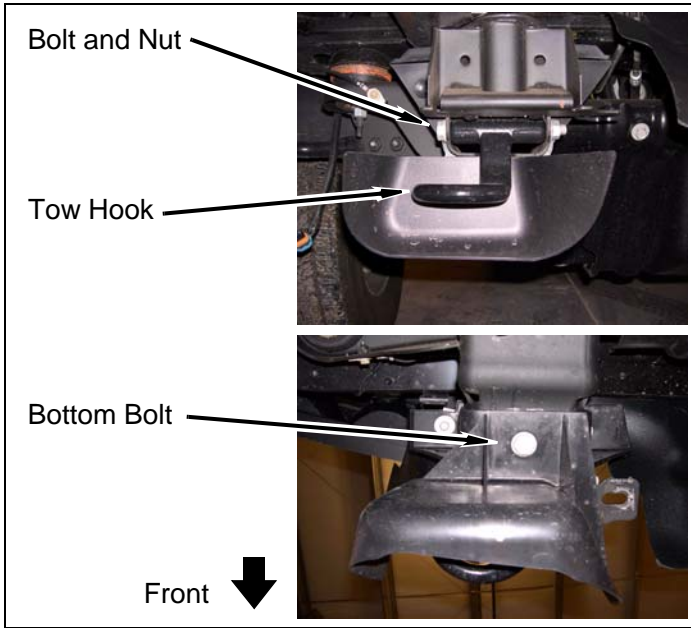

- b. Remove tow hooks.

4. Tow hook covers

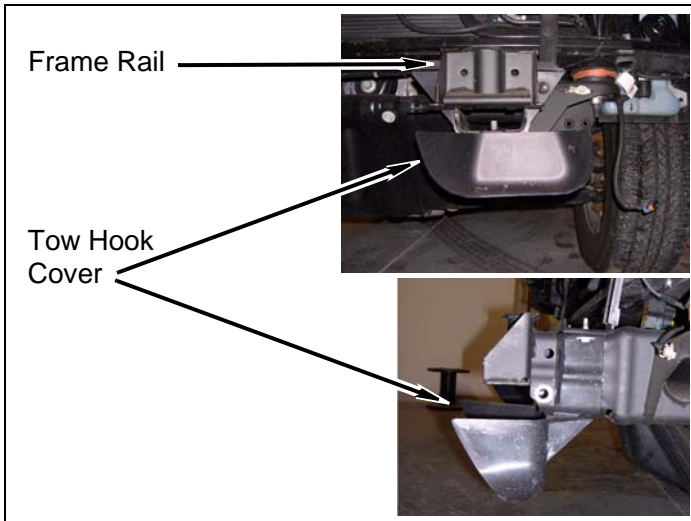

- a. Remove bolts attaching tow hook covers to frame rails.
- b. Remove tow hook covers.

5. Lower guard

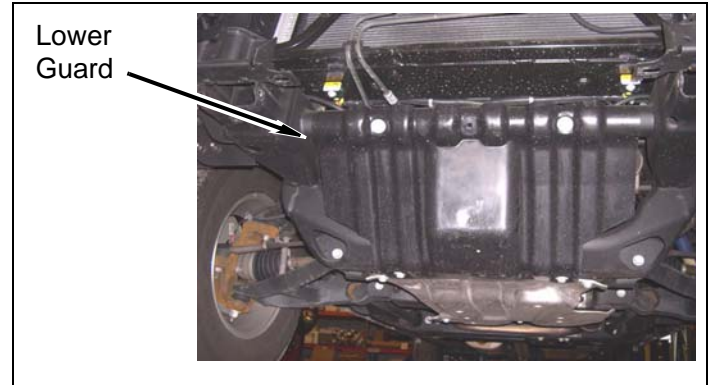

- a. Remove bolts attaching lower guard to core support and frame.
- b. Remove lower guard.

6. Air flap

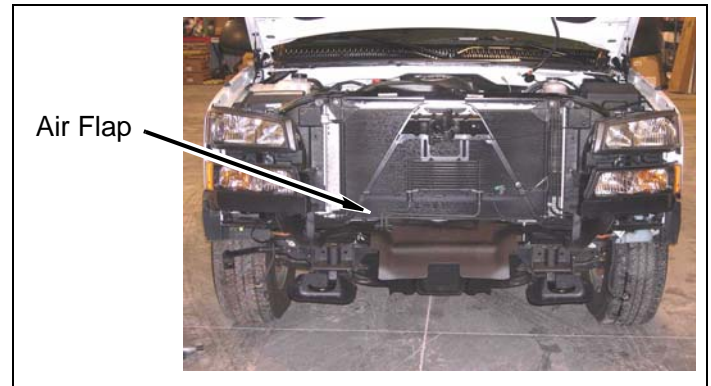

- a. Remove clips attaching air flap. Remove any wire harnesses from air flap
- b. Remove air flap.

7. Transmission cooler

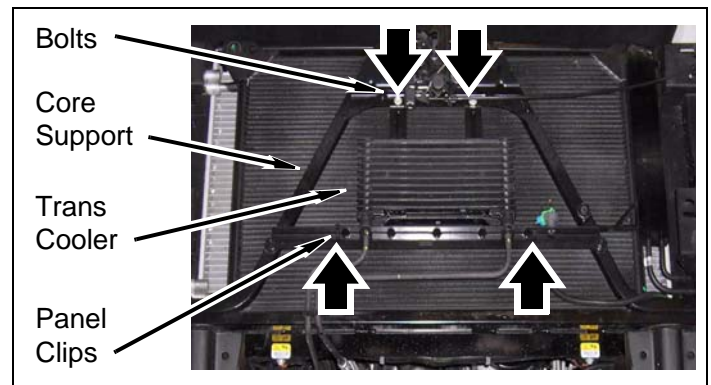

- a. Remove two bolts and two panel clips attaching transmission cooler to core support.

b. Remove cooler lines from core support clip.

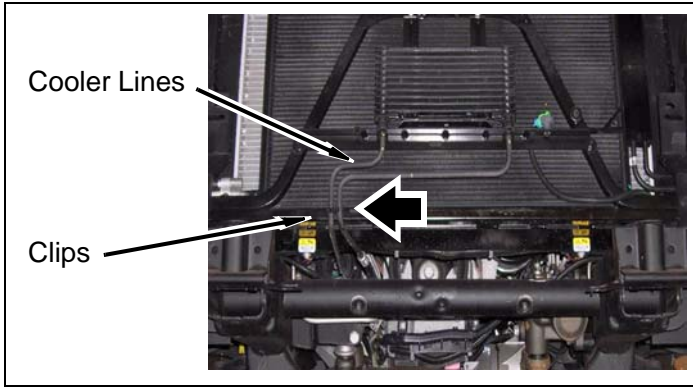

c. Loosen throttle body and air box hose clamps.

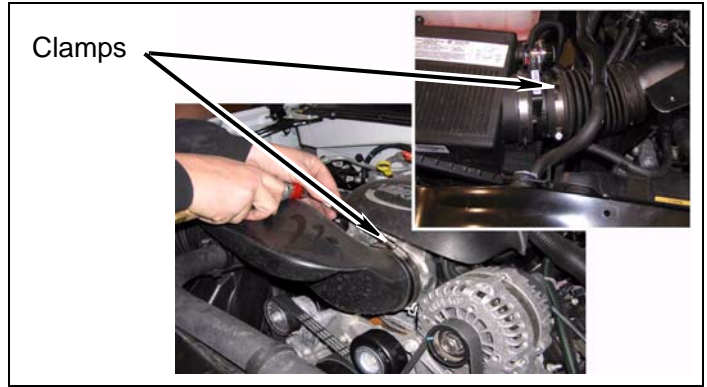

c. Remove transmission cooler from core support and allow cooler to settle on frame.

d. Disconnect overflow and radiator hose from clips.

Engine Compartment

1. Ground strap

- a. Remove nut from stud on firewall.
- b. Disconnect ground strap.

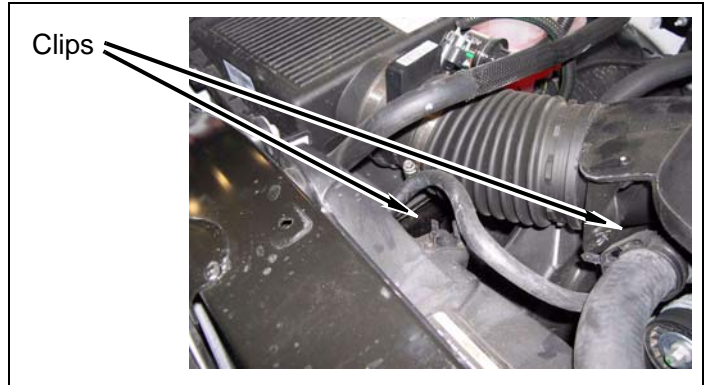
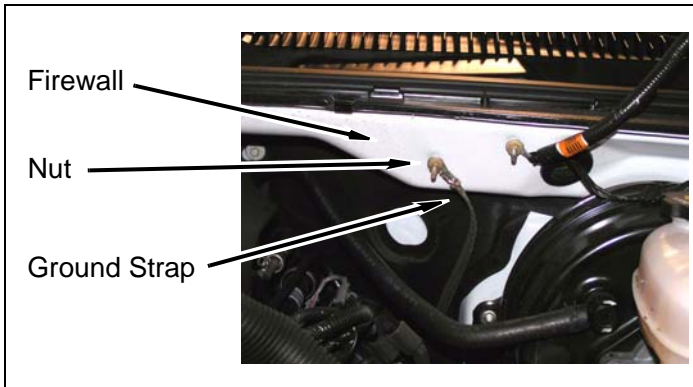

e. Remove engine air intake hose.

3. **Electric fan:** Radiator

a. Remove clip and radiator hose from radiator.

2. Engine

- a. Remove bolt attaching engine cover to top of engine.
- b. Remove engine cover.

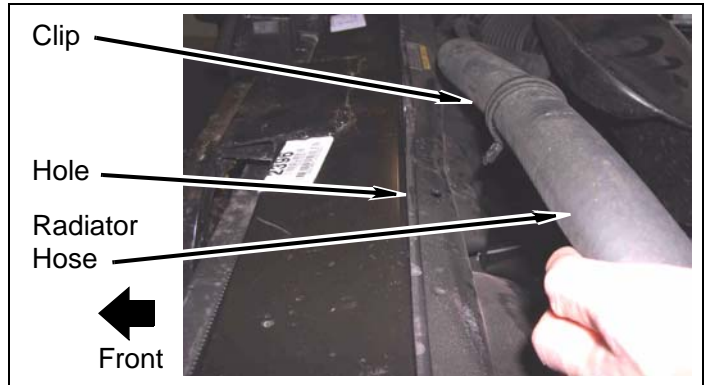
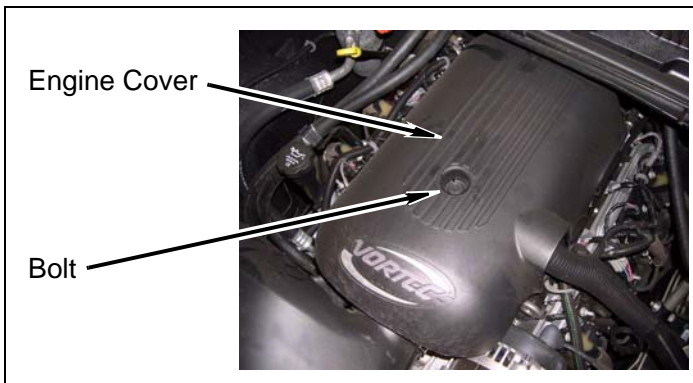

4. **Mechanical fan:** Radiator

a. Remove two bolts from core support.

- b. Remove four pop-ups from top fan shroud and bottom fan shroud.

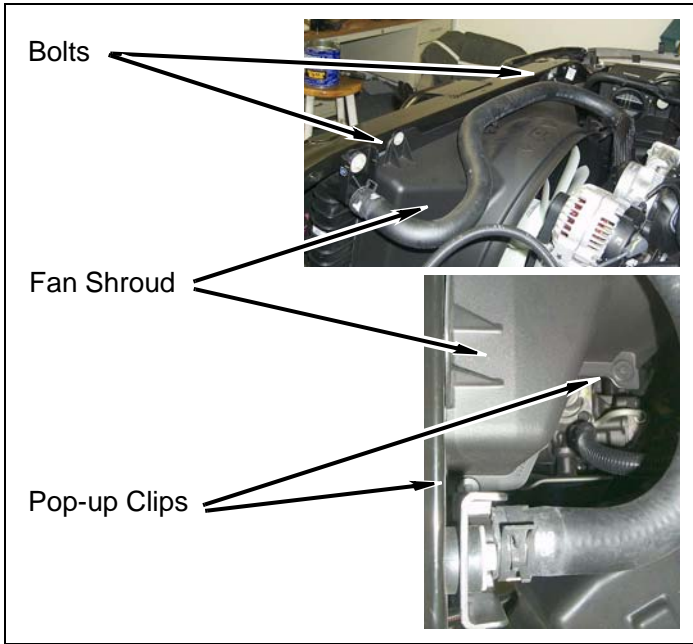

- c. Remove top fan shroud from bottom fan shroud, radiator and vehicle. Rotate bottom fan shroud around fan and remove from vehicle.

- d. Remove four bolts from fan and fan clutch. Rest fan on fan clutch shaft.

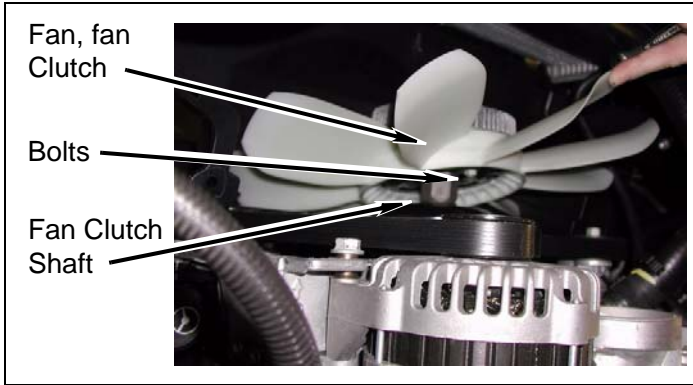

5. Heater hoses

- a. Remove heater hoses from clip.

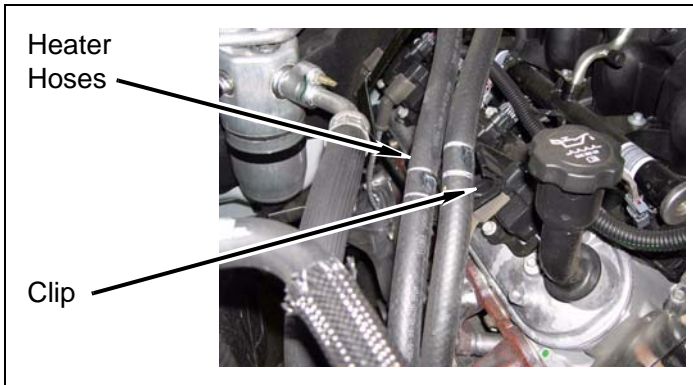

6. Remove wire clip.

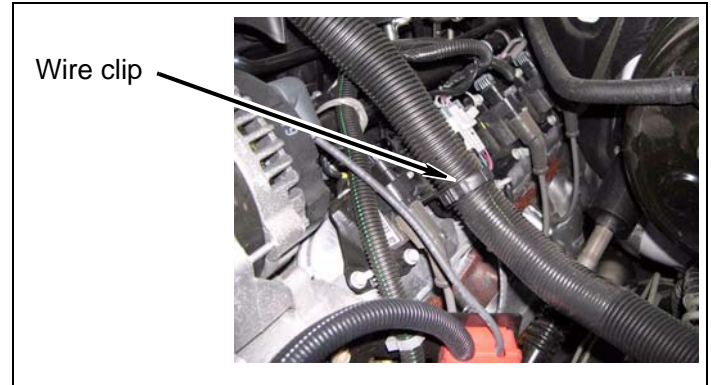

7. Steering shaft

⚠ WARNING

Accidental deployment of the air bag can result in serious personal injury or death. To avoid accidental deployment during installation of the lift kit, the Supplemental Restraint System (SRS, or airbag) must remain deactivated. Do not allow anyone near the airbag during installation. Refer to the factory service manual or owner's manual for the recommended procedure to disable the SRS. After kit installation, the SRS must be reactivated before driving the vehicle.

⚠ CAUTION

If the following step is not performed, the airbag clock-spring could be damaged. Do not turn the steering wheel while the steering shaft is disconnected.

- a. Strap steering wheel to prevent accidental movement.
- b. Mark upper shaft in relation to lower shaft as shown.

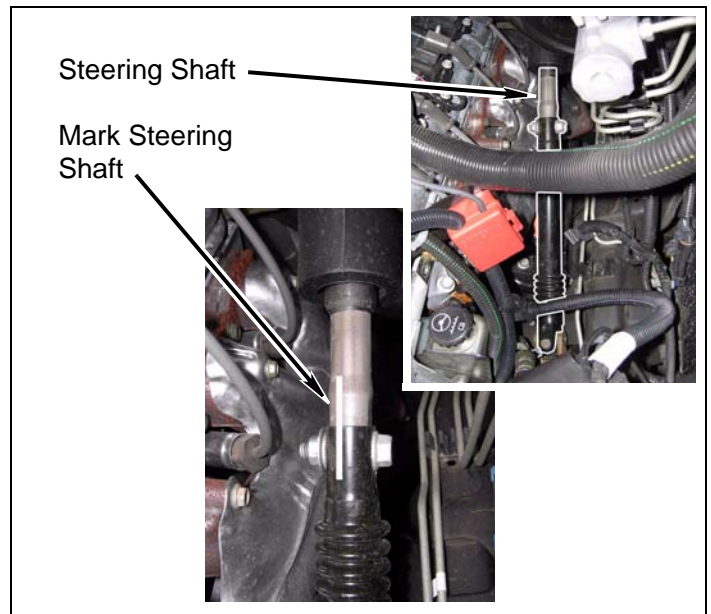

- c. Remove factory bolt and nut connecting upper steering shaft to lower steering shaft.

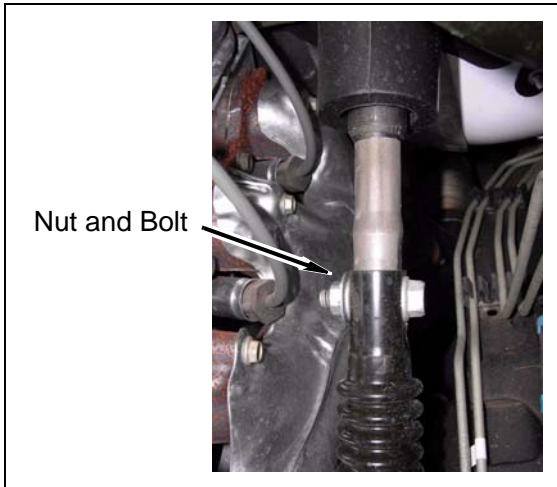

- d. Disconnect steering shaft.

Underside of Vehicle

- 1. Ground strap

- a. Remove bolt attaching ground strap to front cab mount on passenger side.

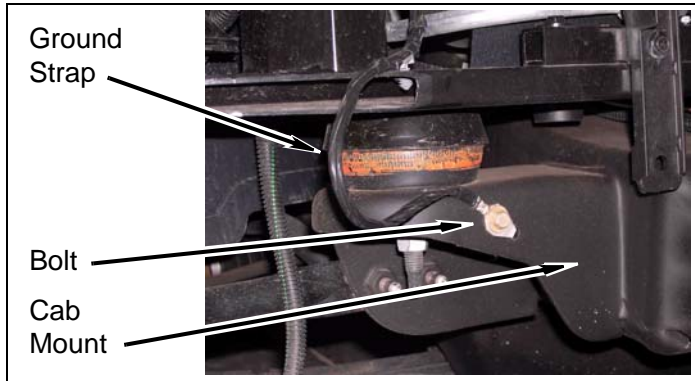

- b. Repeat above step for driver side.

- 2. Brake lines

- a. Carefully pull brake lines from frame rail clips.

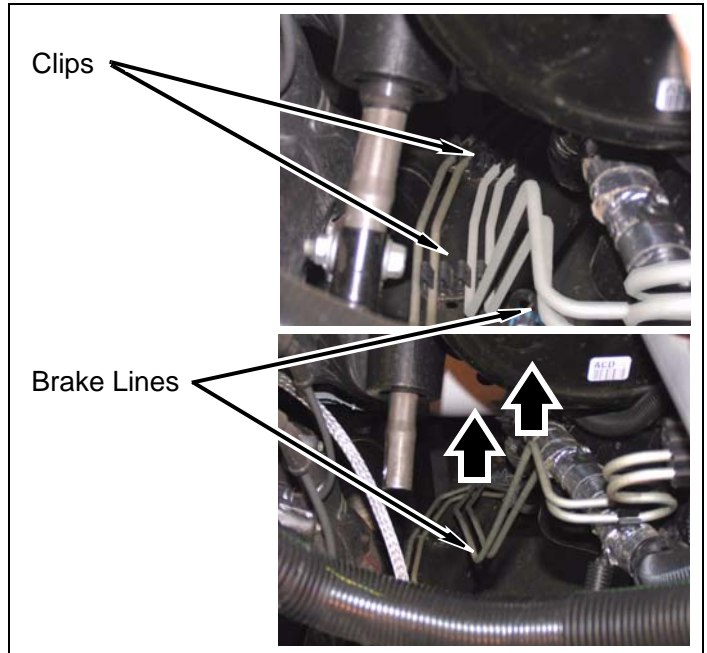

- 3. Wire harnesses

- a. Remove wire harness from clip near brake lines.

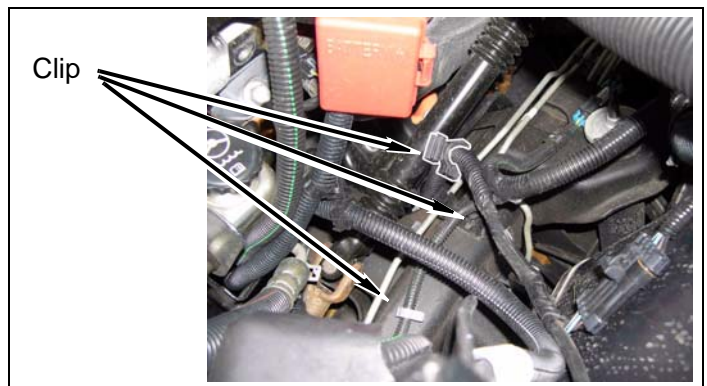

b. Remove wire harness from harness clip.

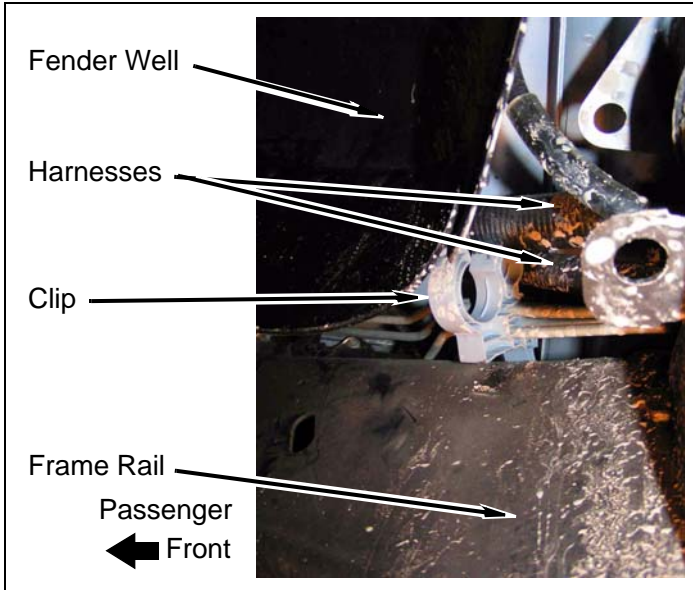

c. Remove harness clips from frame rail. Remove bolts attaching ground straps to frame.

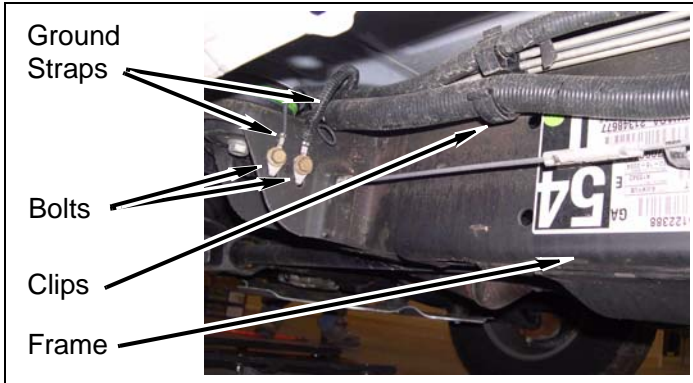

d. Remove wire clips from body and frame rail along passenger side.

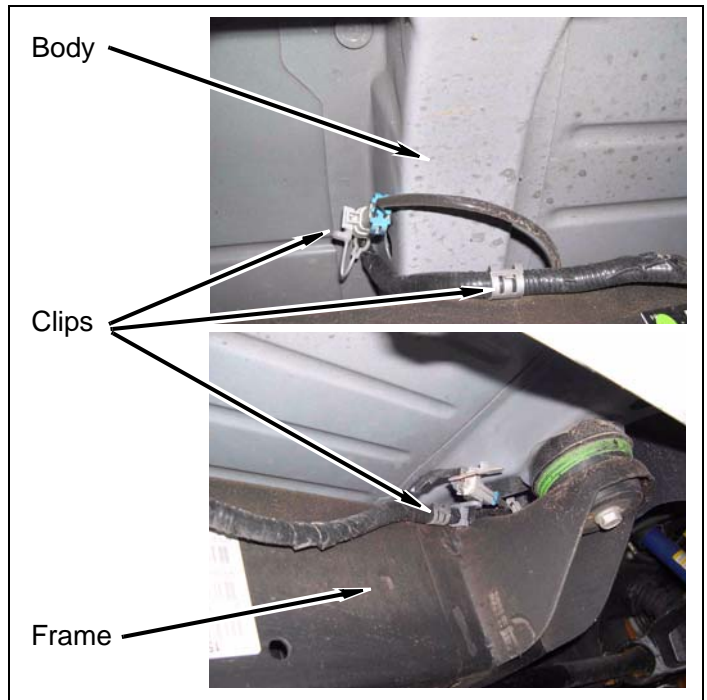

4. **Without adjuster:** Parking brake cable

- a. Pull slack into parking brake cable. Attach locking pliers to parking brake cable to allow slack, if necessary.
- b. Use expanding pliers to disconnect parking brake cable from junction.

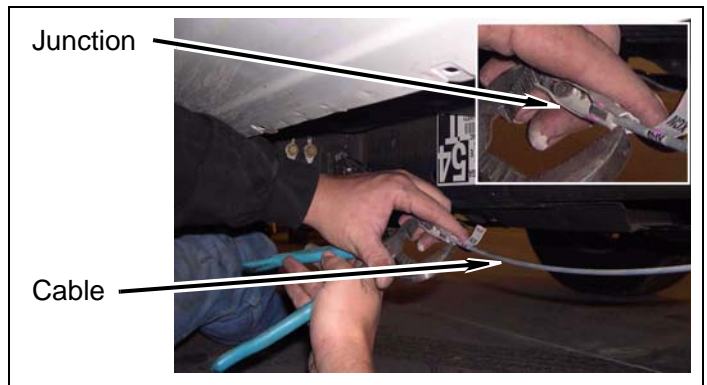

5. With adjuster: Parking brake cable

- a. Measure length of threads on parking brake cable adjuster. Remove nut from cable adjuster and clevis.

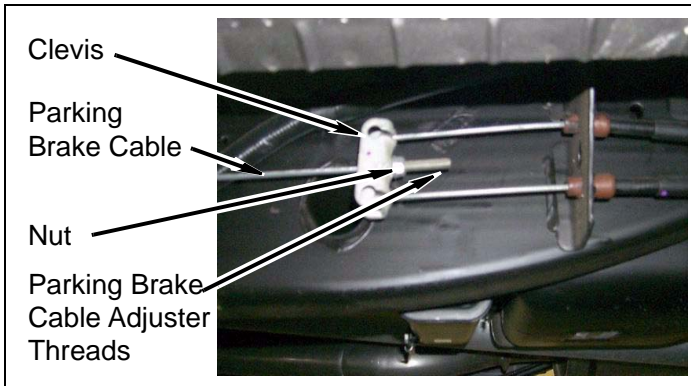

- b. Pull parking brake cable through two frame mounting pads.

Rear of Vehicle

1. Fuel filler

⚠ WARNING

Use extreme caution when working near fuel line(s) and fuel tank(s). Clean up spilled fuel immediately. Any spark could cause an explosion or fire resulting in serious personal injury and/or property damage.

- a. Remove fuel filler cap.
- b. Remove three bolts attaching fuel filler to bed.

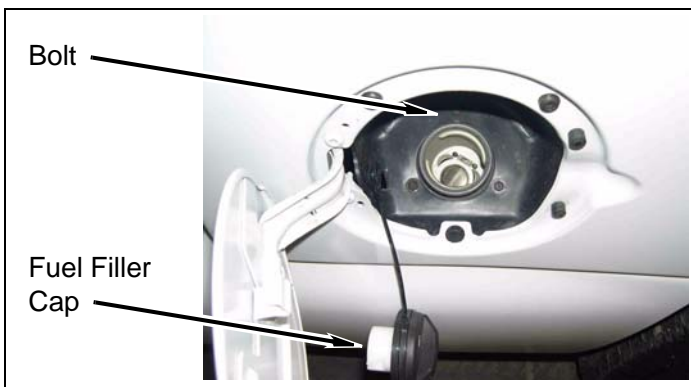

Inside of Vehicle

NOTE:

1. Manual transmission shift lever

- a. Remove four screws and four pop-ups from shift boot and floorboard. Slide shift boot up onto shift lever.

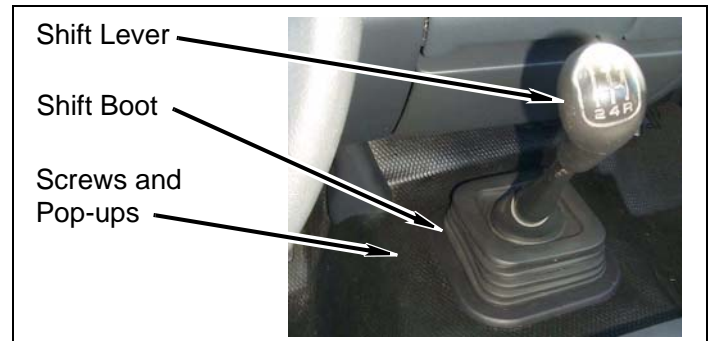

- b. Loosen jam nut on input lever. Remove shift lever from input lever.

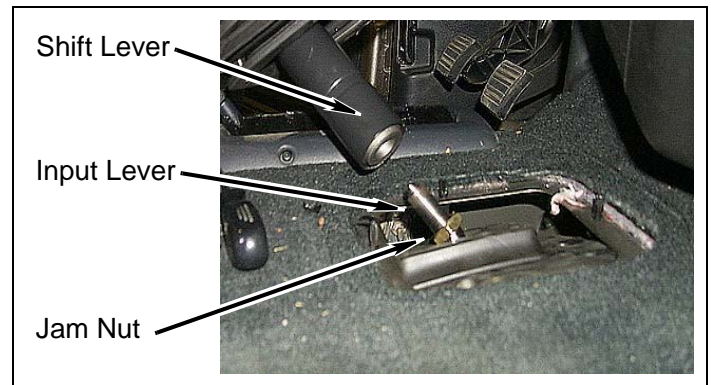

NOTE:

Do not remove rear bumper at this time. Rear bumper can not be removed until bed lifting procedures have been completed.

Install Kit

Cab

1. Prepare to lift cab from frame

- a. Loosen, but **DO NOT REMOVE**, cab mounting bolts on driver side.

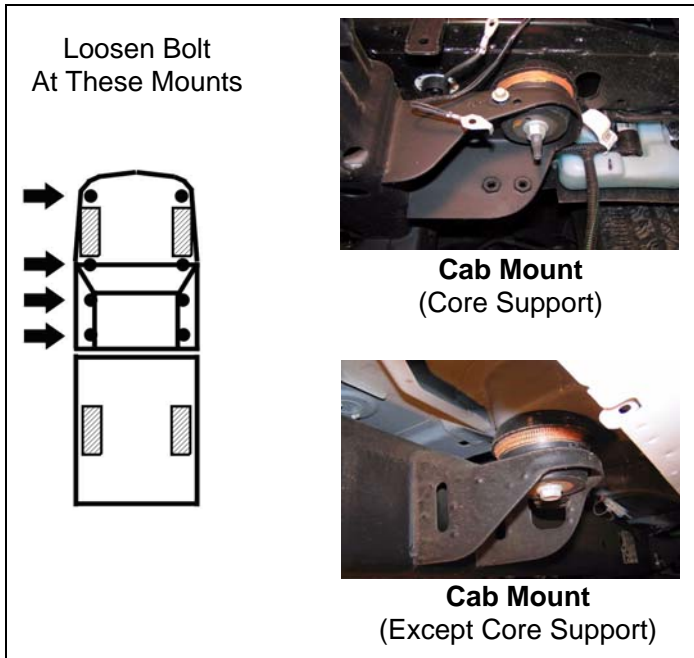

NOTE:
The number of cab mounting bolts may vary with the length of the cab.

- b. Remove bolt and lower bushing from each cab mount on passenger side. Retain factory nut from front core support cab mount.

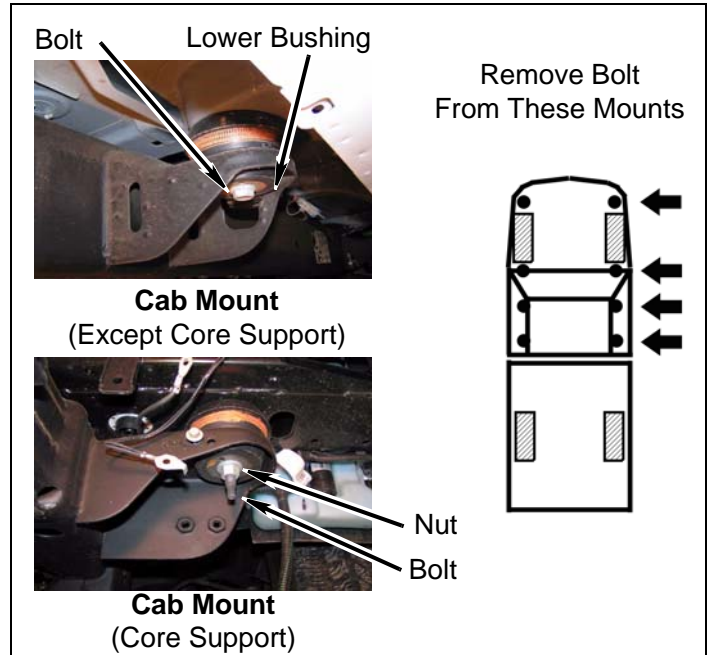

NOTE:

Bolts in front two cab mounts are mounted down and through core support.

⚠ WARNING

Use extreme caution when lifting body from frame. To prevent serious personal injury, ensure the lifting device is securely placed. Keep your hands out from between the body and frame.

⚠ CAUTION

Continually check hoses, wires, lines, etc. to be sure that everything is flexing properly and not binding, or damage to the vehicle could result. Be especially careful of the a/c hoses at the fire wall, the belt pulley, and at the core support. Ensure brake lines stretch while lifting. Bending the lines to gain ample slack may be necessary. Be extremely careful not to kink the lines.

2. Cab passenger side

- a. Position a hydraulic jack and a wood block under passenger side of cab (under the body seam). Slowly lift cab just enough to install a **kit block** on top of factory upper bushing.

⚠ WARNING

The **kit blocks** must be installed in addition to the factory upper and lower bushings. Installing the **kit blocks** without the factory upper and lower bushings could result in damage to the vehicle or serious personal injury.

- b. Place **kit blocks** (3" diameter) on metal cups and upper bushings on each cab mount. DO NOT INSTALL lower bushings at this time.

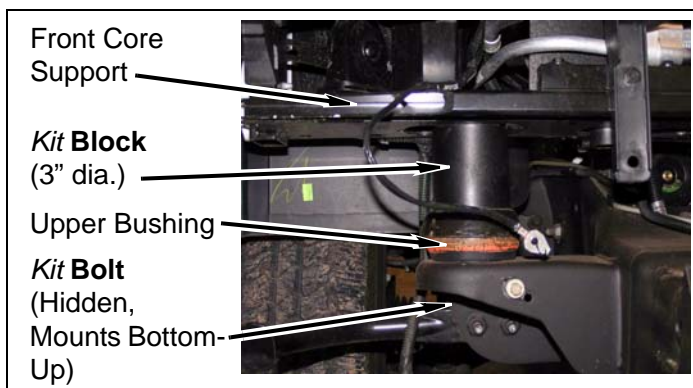
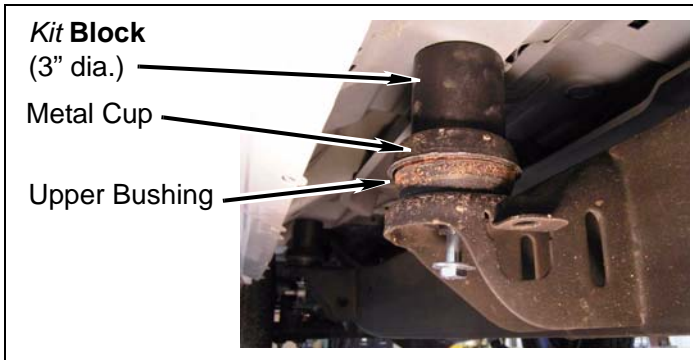

- c. Lower cab onto **kit blocks** (3" diameter).

- d. Install lower bushing, **kit bolt** (12mm-1.75 x 160mm, 2" kit **OR** x 180mm, 3" kit), **kit washer** (7/16" USS) on each cab mount, except front core support mount. DO NOT TIGHTEN.

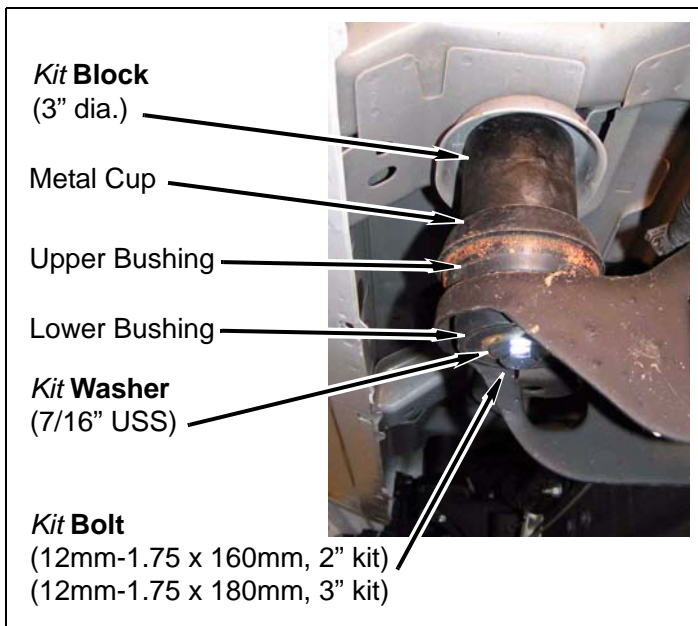

- e. Install lower bushing, **kit bolt** (12mm-1.75 x 160mm, 2" kit **OR** x 180mm, 3" kit), **kit washer** (7/16" USS) on front core support cab mount. Use factory front core support cab mount nut. DO NOT TIGHTEN.

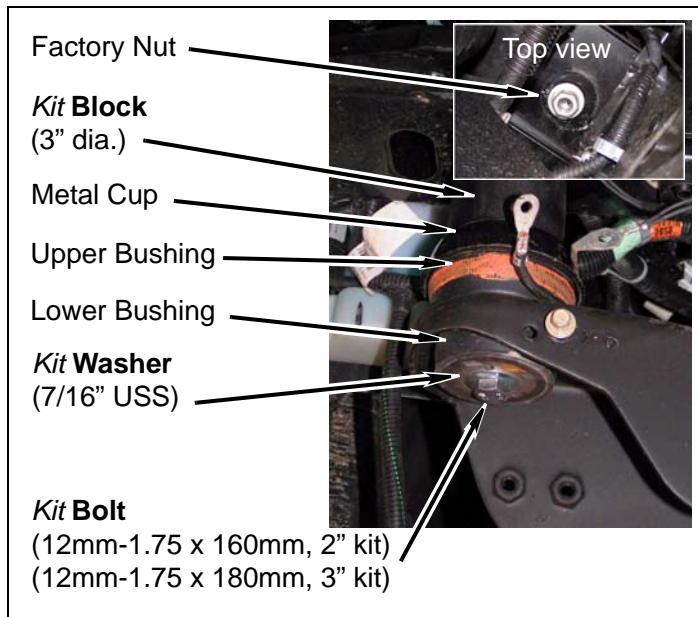

3. Cab driver side

- a. Repeat previous steps on driver side of cab.
- b. Set cab-to-bed spacing according to previous measurement.

- c. Remove each *kit bolt*, one at a time, and apply a few drops of *kit Loctite*® to threads. Install *kit bolt*, *kit washer* (7/16" USS), and lower bushing. Tighten *kit bolt*.

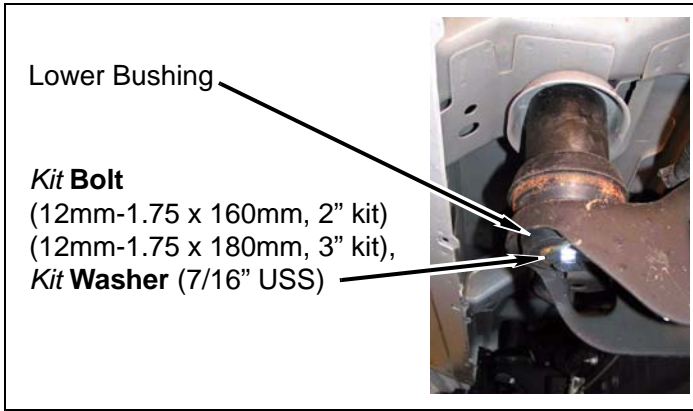

Bed

1. Prepare to lift bed from frame
 - a. Loosen, but **DO NOT REMOVE**, bed mounting bolts on driver side.

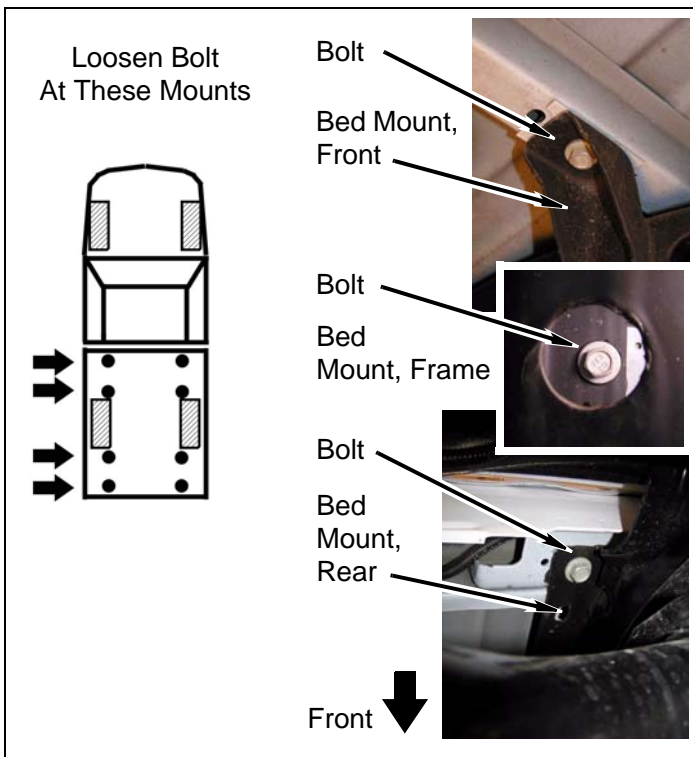

NOTE:

The number of bed mounting bolts may vary with the length of the bed.

2. Remove bolt from each bed mount on passenger side.

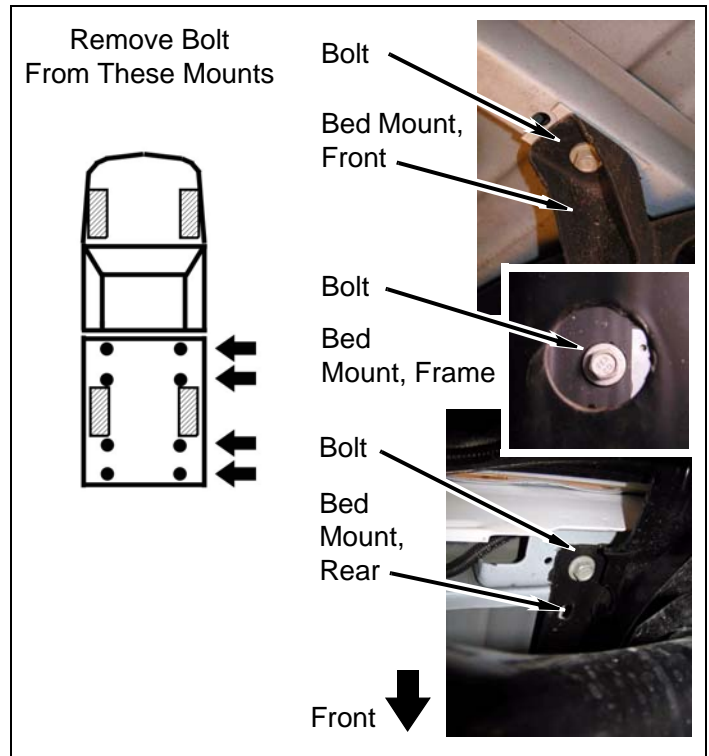

⚠ WARNING

Use extreme caution when lifting the bed from the frame. To prevent serious personal injury, ensure the lifting device is securely placed. Keep your hands out from between the bed and frame.

⚠ CAUTION

To prevent damage to the vehicle while lifting the bed, continually check hoses, wires, brake lines, etc. to ensure everything is flexing properly and not binding. Ensure clearance between bed and cab is maintained.

3. Bed passenger side
 - a. Using a hydraulic jack and a wood block, slowly lift bed just enough to install a *kit bolt*.

- b. Place a **kit block** (3" diameter) on frame at front bed mount.

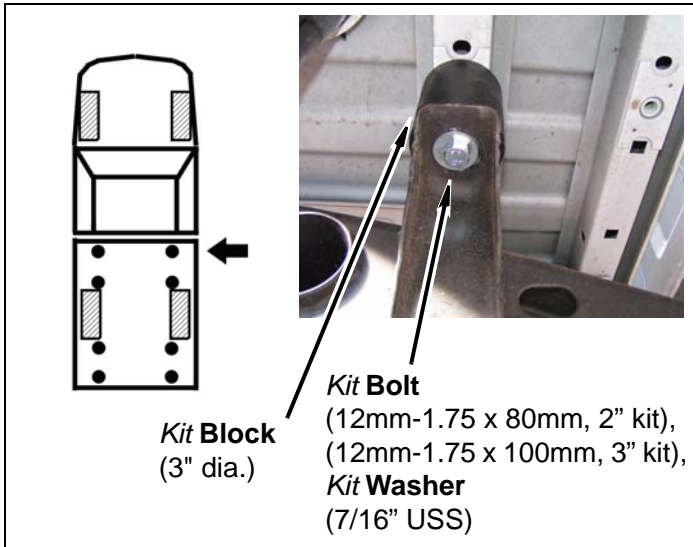

- c. Place one (or two, if long bed) **kit block(s)** (3" diameter) on one (or two) frame mounts.

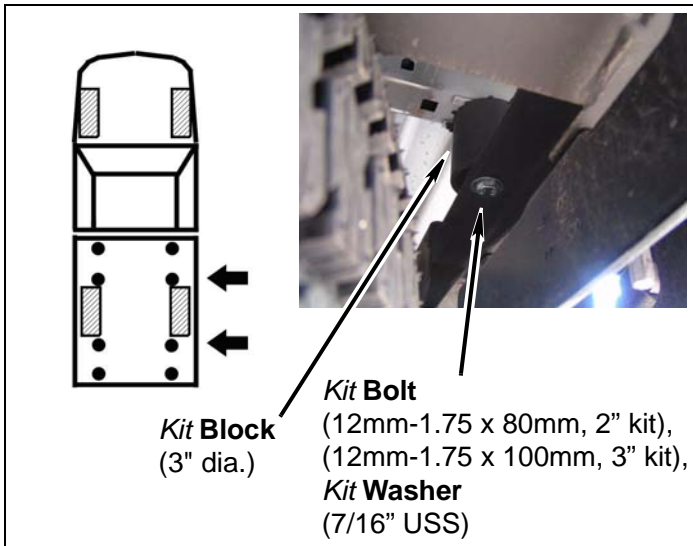

- d. Place a **kit block** (2" diameter) on rear bed frame mount.

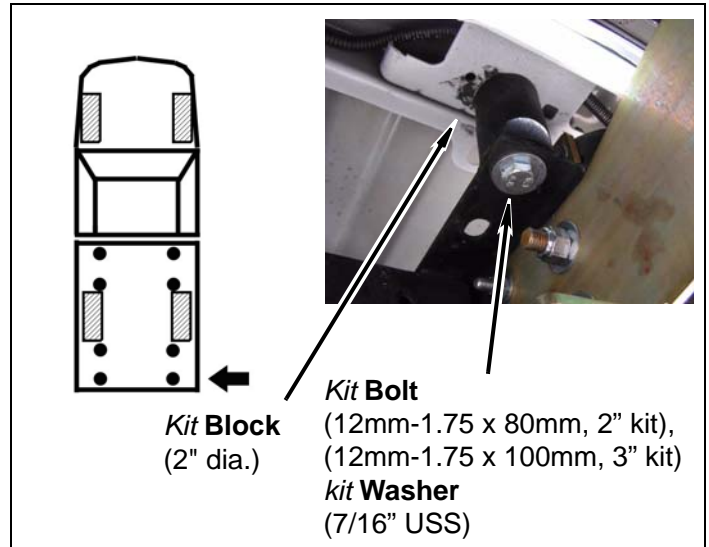

- e. Lower bed onto **kit blocks**.

- f. At each bed mount, install **kit bolts** (12mm-1.75 x 80mm, 2" kit **OR** x 100mm, 3" kit) and **kit washers** (7/16" USS). **DO NOT TIGHTEN.**

4. Bed driver side

- Repeat previous steps on driver side of bed.
- Set bed-to-cab spacing according to previous measurement.
- Remove each **kit bolt**, one at a time, and apply a few drops of **kit Loctite®** to threads. Install **kit bolt** with **kit washer** (7/16" USS). Tighten **kit bolt**.

Rear of Vehicle

1. Rear bumper.

- Disconnect bumper wiring harness from frame.

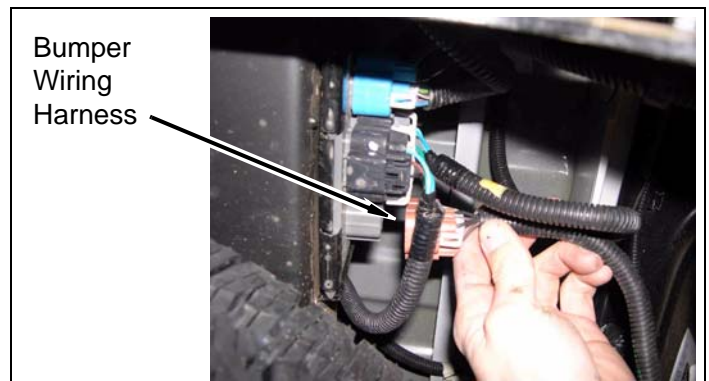

b. Remove six bolts and six nuts attaching bumper and bumper brackets to frame.

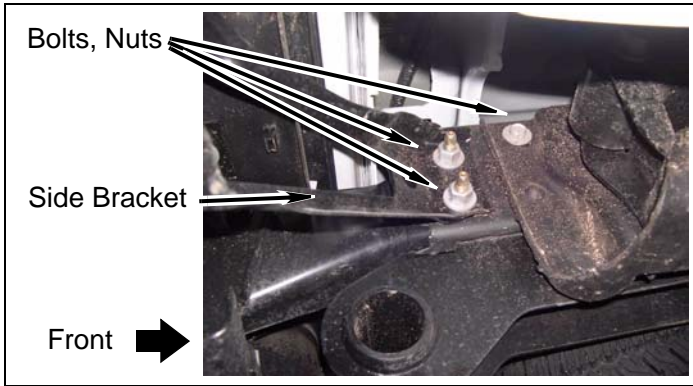

c. Remove two most rearward bolts attaching hitch to frame.

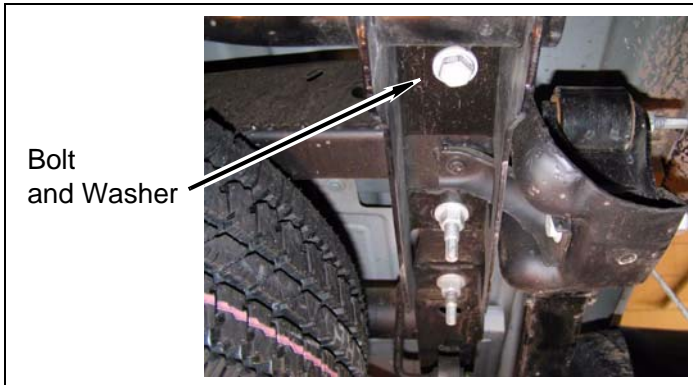

d. Remove two bolts attaching trailer hitch to bumper, if equipped.

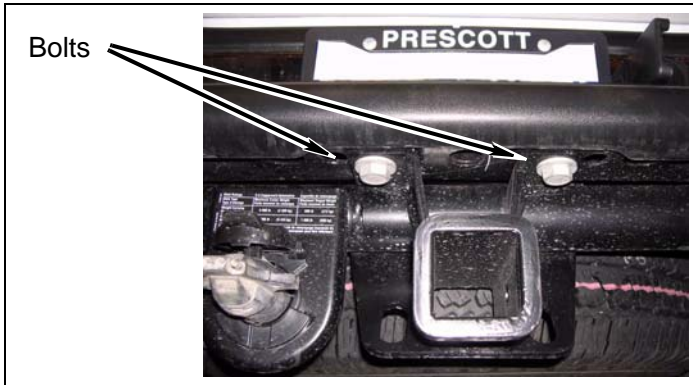

e. Remove rear bumper.

f. Remove driver and passenger factory bumper brackets from rear bumper.

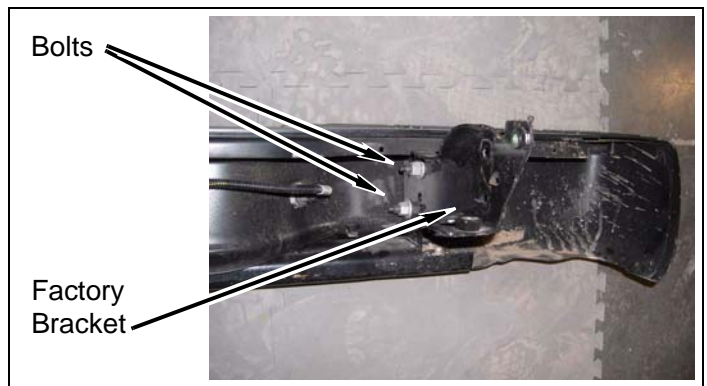

⚠ WARNING

The following procedure is intended only to enhance the appearance of the vehicle. The rear bumper will no longer be rated for towing of any kind. Towing with the rear bumper after it has been lifted can result in death, serious personal injury, or damage to the vehicle. Towing after the bumper has been lifted should be accomplished using a rated Class III receiver type hitch.

g. Trim frame for spare tire winch tube as shown.



h. Install **kit bracket** (rear bumper, passenger) to rear bumper with factory hardware.

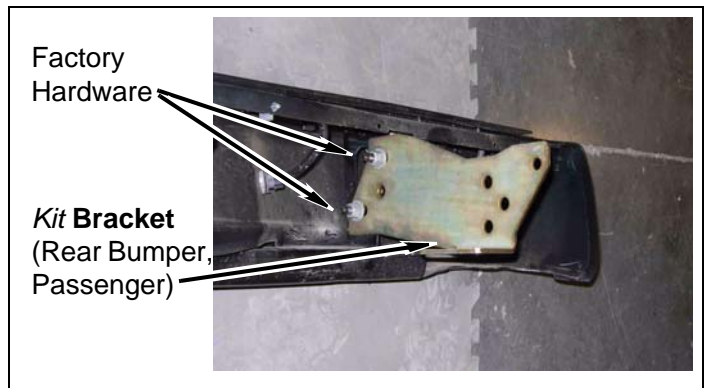

i. Repeat above procedure for **kit bracket** (rear bumper, driver).

- j. Install rear bumper onto frame. Ensure spare tire winch tube aligns with hole in bumper.
- k. **2" kit:** Rotate two outside bumper brackets over two **kit brackets** (rear bumper, 1-stud) and install with two **kit washers** (1/2" USS) and two **kit nuts** (1/2" Nylock). DO NOT TIGHTEN.

- n. **3" kit:** Install two **kit brackets** (rear bumper, 3-stud) onto vehicle along with two **kit bolts** (7/16" x 1-1/2") and two **kit washers** (7/16" USS) as shown.

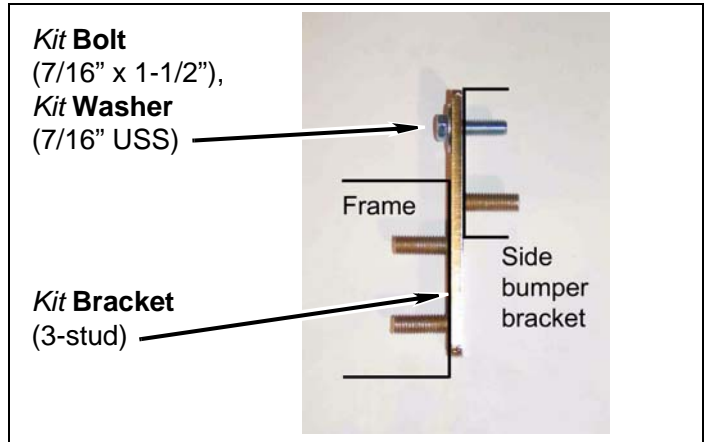
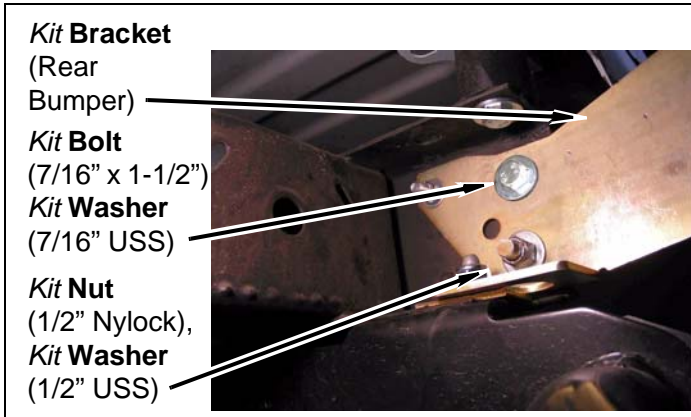

- l. **2" kit:** Install **kit brackets** (rear bumper, 1-stud) with four **kit bolts** (7/16" x 1-1/2"), eight **kit washers** (7/16" USS) and four **kit nuts** (7/16" Nylock). DO NOT TIGHTEN.

- o. **3" kit:** Install two **kit brackets** (rear bumper, 3-stud) with six **kit nuts** (1/2" Nylock), six **kit washers** (1/2" USS), two **kit nuts** (7/16" Nylock) and two **kit washers** (7/16" USS). DO NOT TIGHTEN.

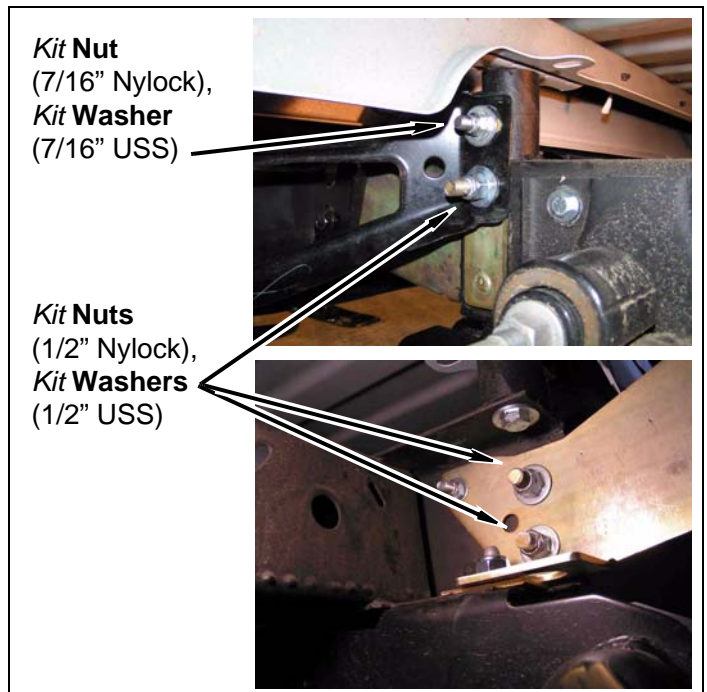
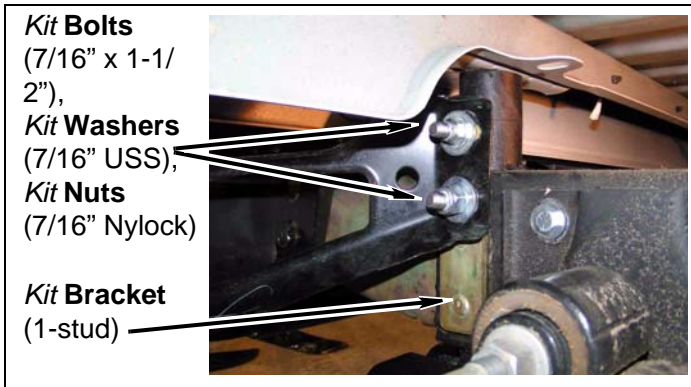

- m. **2" kit:** Install two **kit bolts** (3/8"-16 x 1-1/2"), two **kit nuts** (3/8"-16 Nylock) and four **kit washers** (3/8" USS) to two **kit brackets** (rear bumper). DO NOT TIGHTEN.

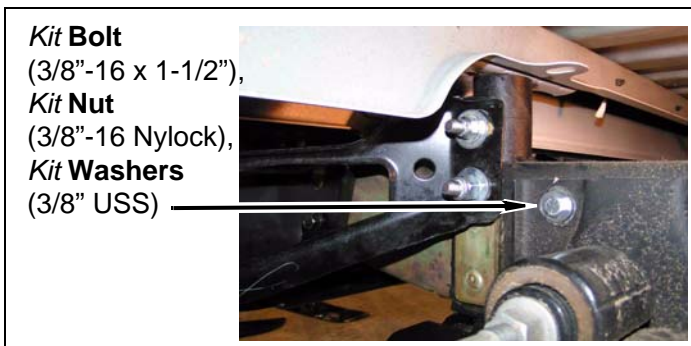

- p. **3" kit:** Install two **kit bolts** (3/8"-16 x 1-1/2"), two **kit nuts** (3/8"-16 Nylock) and four **kit washers** (3/8" USS) to two **kit brackets** (rear bumper). DO NOT TIGHTEN.



- r. Place **kit blocks** (2" diameter, drilled) between rear bumper and trailer hitch, if equipped. Install two **kit bolts** (14mm-2.0 x 110mm) and two **kit washers** (14mm). DO NOT TIGHTEN.

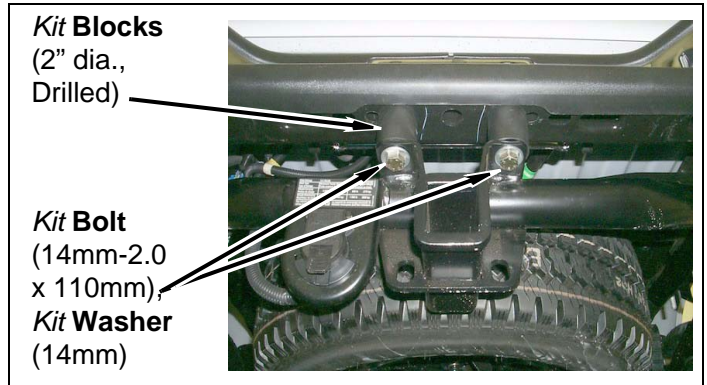

- s. Align rear bumper to previous bed-to-bumper measurements. Tighten all hardware.
- t. Connect bumper wiring harness to bed connector.

2. Crush blocks

- q. Install trailer hitch to two **kit brackets** (rear bumper) with factory bolt and washer, two **kit nuts** (14mm Nylock), two **kit washers** (14mm) and two **kit washers** (square) as shown. DO NOT TIGHTEN.

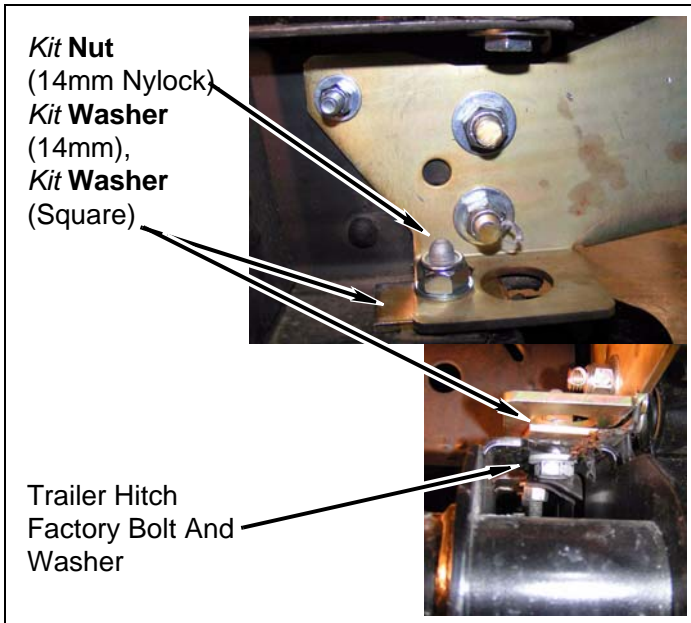

- a. Remove two (four, if long bed) plastic discs from top of frame.

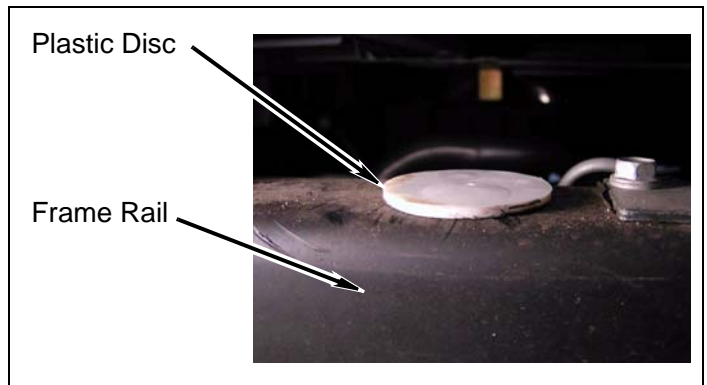

- b. Install **kit blocks** (3" crush) in place of plastic discs with **kit bolt** (5/16" x 3/4" Hex head) and **kit washer** (5/16" USS).

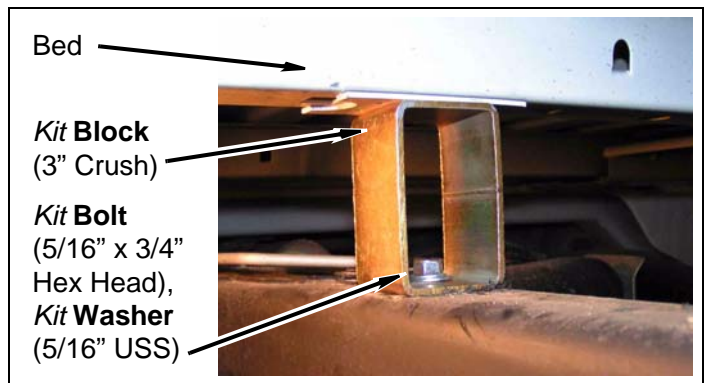

3. 2003 models: Fuel filler

⚠ WARNING

Use extreme caution when working near the fuel lines and the fuel tank. Clean up spilled fuel immediately. A spark could cause an explosion or fire resulting in serious personal injury and property damage.

- a. Remove clamp and filler hose from fuel tank. Leave ground wire and vent hose attached to fuel filler neck.

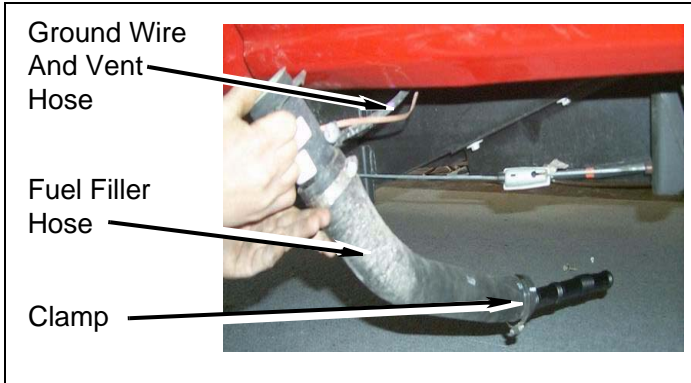

- b. Carefully cut filler hose in half as shown. DO NOT CUT THROUGH PLASTIC TUBE INSIDE FILLER HOSE.

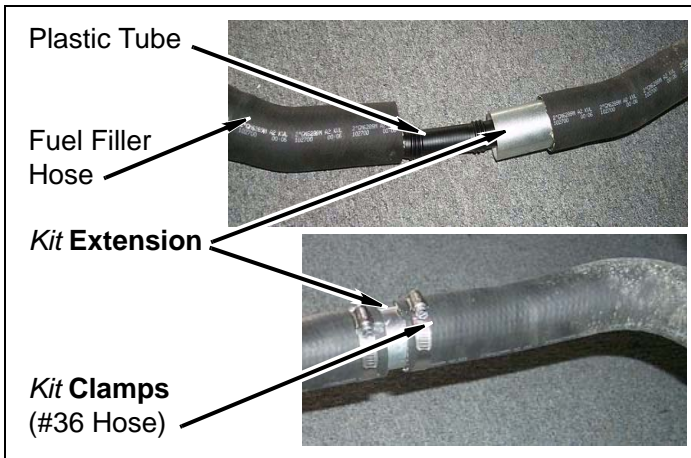

- c. Install *kit extension* (fuel filler, metal) with two *kit clamps* (#36 hose).

- d. Install fuel filler hose on fuel tank with clamp.

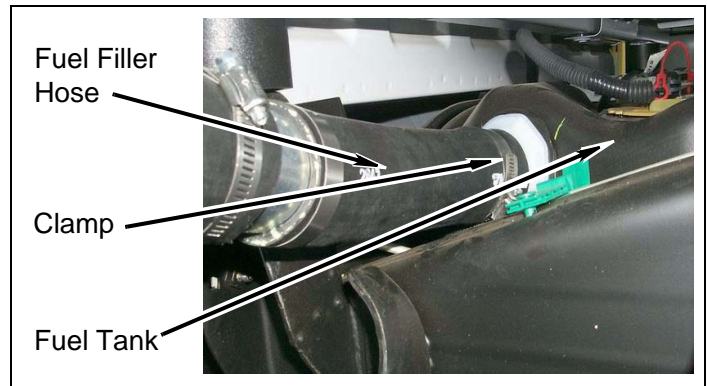

- e. Install fuel filler to body with three factory bolts.

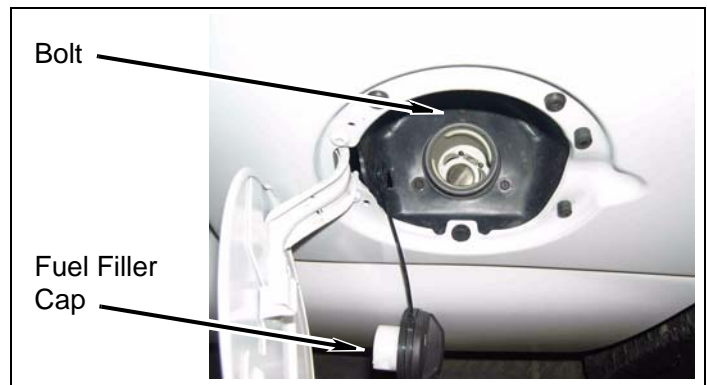

4. 2004-2005 models: Fuel filler

- a. Remove bolt attaching fuel filler ground wire from bed and disconnect ground wire.

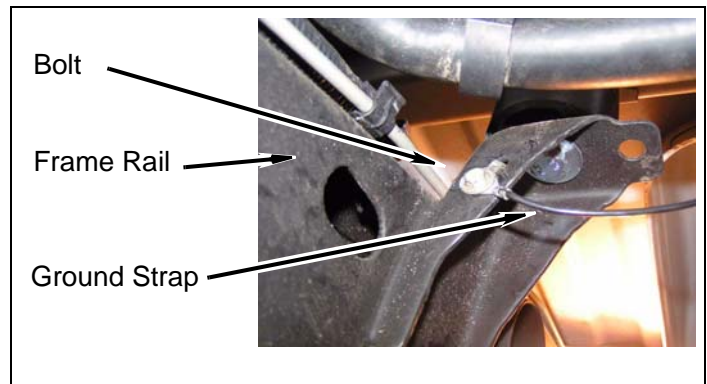

b. Loosen hose clamps on fuel filler hose and vent hose.

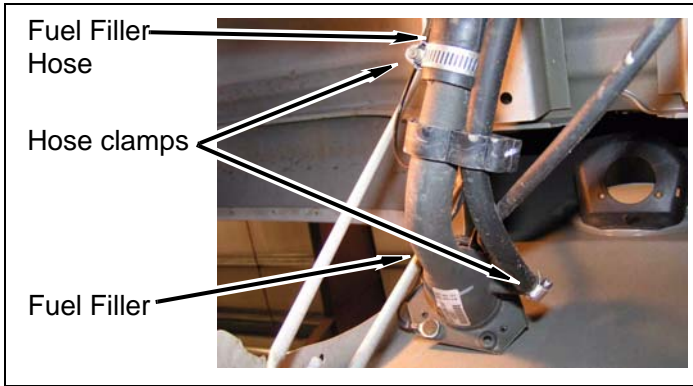

c. Remove clips securing fuel filler hose to vent hose.

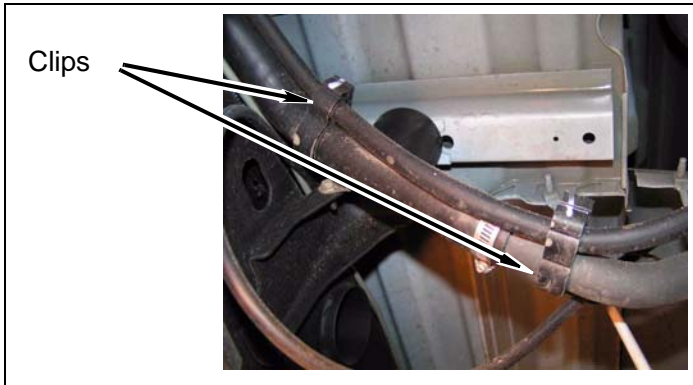

d. Remove fuel filler from vehicle.

e. Mark and cut fuel filler neck as shown.

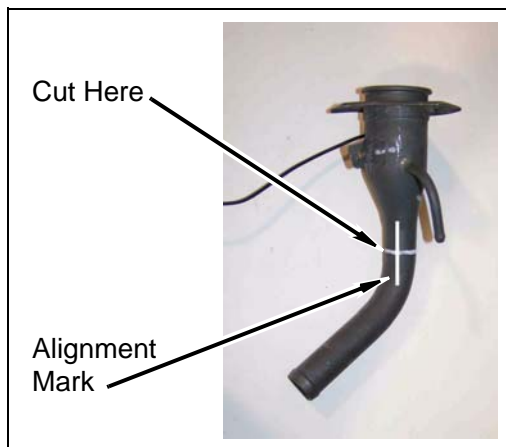

f. Deburr edges of cut ends to prevent fuel tank contamination.

g. Install **kit extension** (fuel filler, rubber) with two **kit clamps** (#20 hose). DO NOT TIGHTEN.

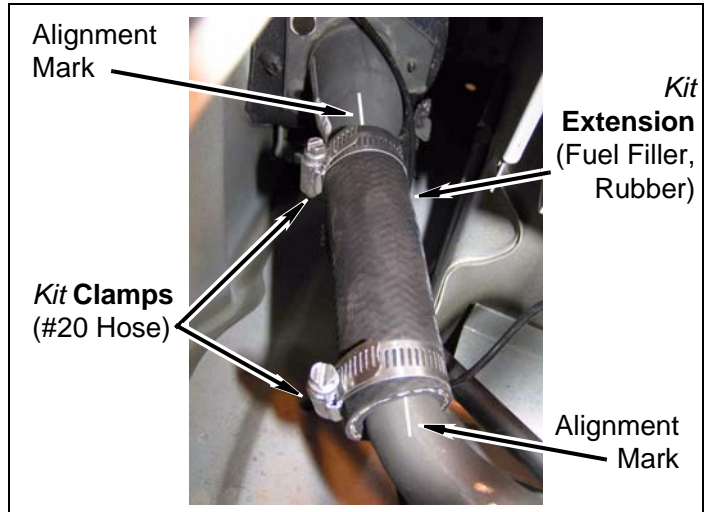

h. Install fuel filler to body with three factory bolts.

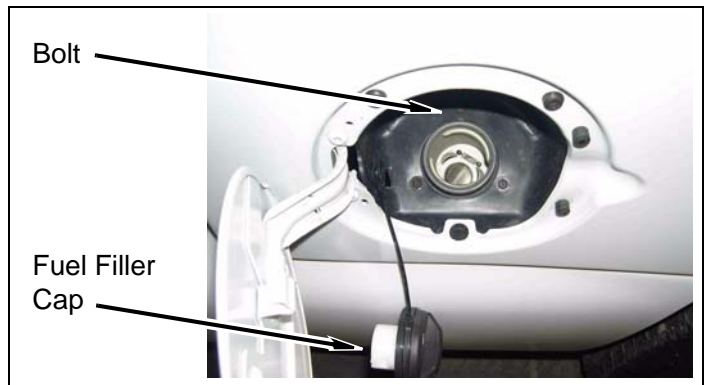

i. Install fuel filler to fuel filler hose. Adjust **kit extension** (fuel filler, rubber) and fuel filler hose. Tighten **kit clamps** (#20 hose) and fuel filler hose clamp. Install fuel filler vent hose to fuel filler and tighten vent hose clamp.

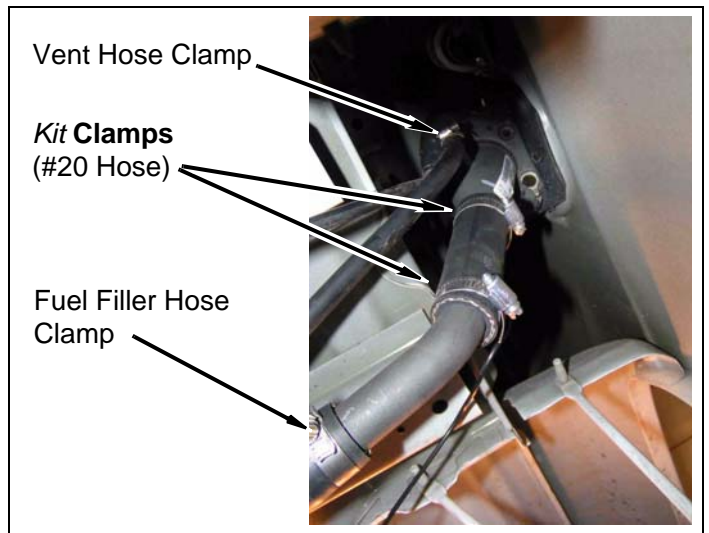

j. Install fuel filler hose clips.

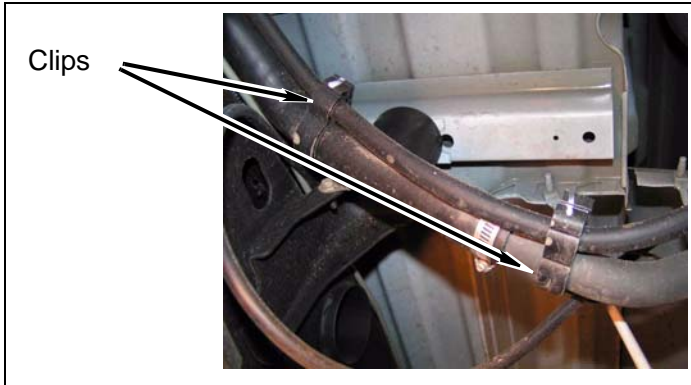

k. Install ground wire to frame rail with factory bolt.

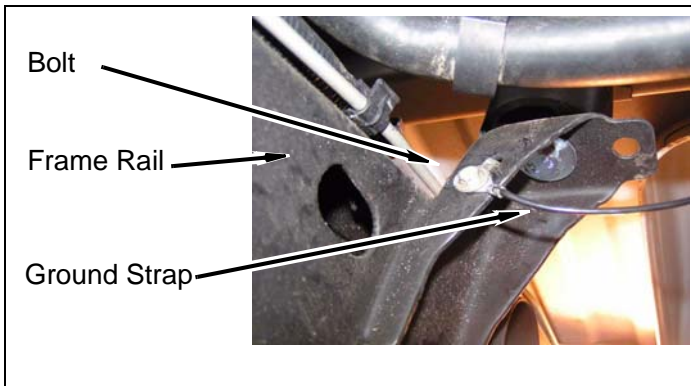

Underside of Vehicle

NOTE:

The following procedures are intended for vehicles with manual transfer case ONLY. The following procedures may not be necessary for 2" kit. Check transfer case engagement in all gears.

1. Transfer case linkage

a. Remove three hard lines and clip from bracket.

b. Remove wiring harness push clip and wiring harness from bracket. Some vehicles may be equipped with an extra wiring harness. This extra harness must also be removed from bracket.

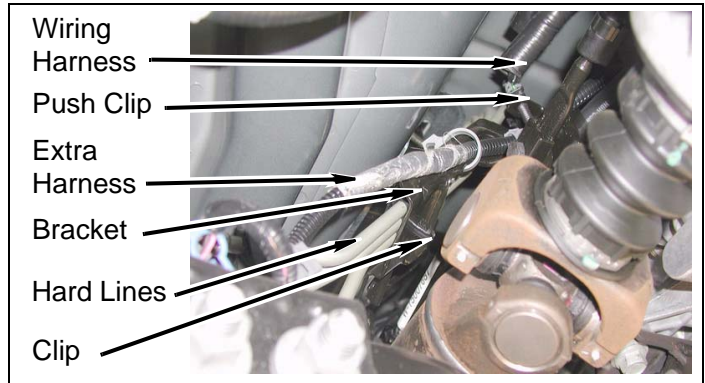

c. Remove two nuts and bracket from transfer case.

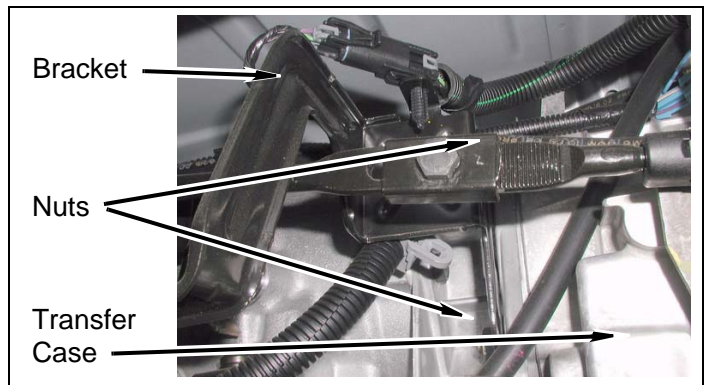

d. Install two nuts on transfer case where removed from the step above. Tighten two nuts to 35 lb.-ft.

e. Remove two clips and transfer case linkage rod from transfer case and pivot.

- f. Scribe a line along side of transfer case linkage rod as shown. Cut rod into two pieces through line and deburr as necessary.

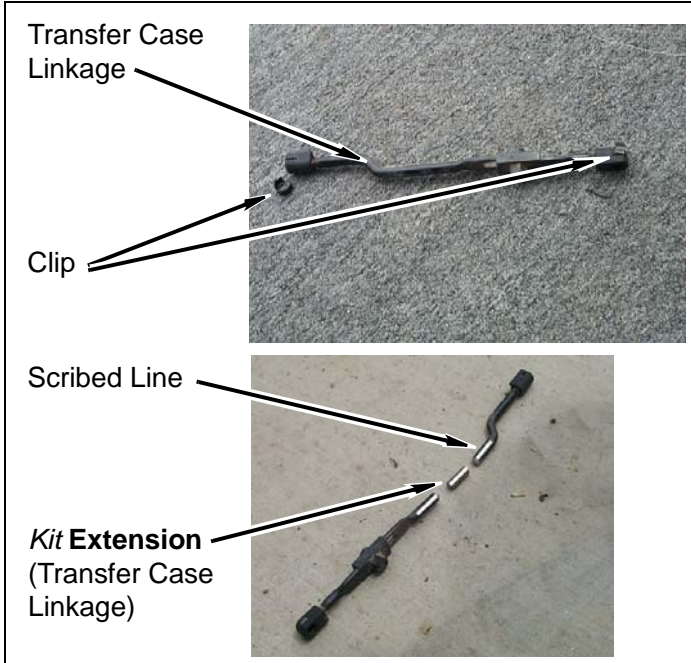

- b. Route parking brake cable through largest hole in **kit bracket** (parking brake).
- c. Install **kit bracket** (parking brake) to mounting pad using two **kit bolts** (5/16" x 1"), four **kit washers** (5/16" USS) and two **kit nuts** (5/16" Nylock).

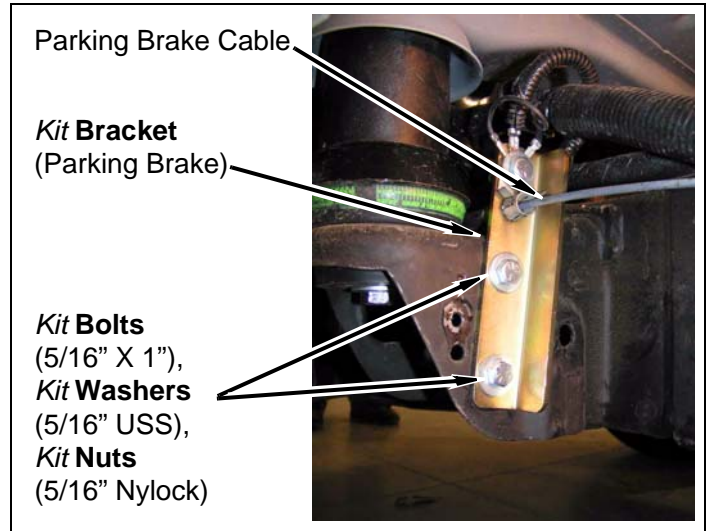

WARNING

A certified welder should perform all welding.

- g. Position **kit extension** (transfer case linkage) between two cut pieces of transfer case linkage rod. Ensure **kit extension** and lever scribed lines align. Weld **kit extension** in place.
- h. Install transfer case linkage rod on transfer case and pivot with two clips.
- i. Check transfer case shift lever operation. Ensure there is complete engagement in all ranges. If necessary, adjust linkage.

- d. Install two ground wires on **kit bracket** (parking brake) with **kit bolt** (5/16" x 1"), two **kit washers** (5/16" USS) and **kit nut** (5/16" Nylock).

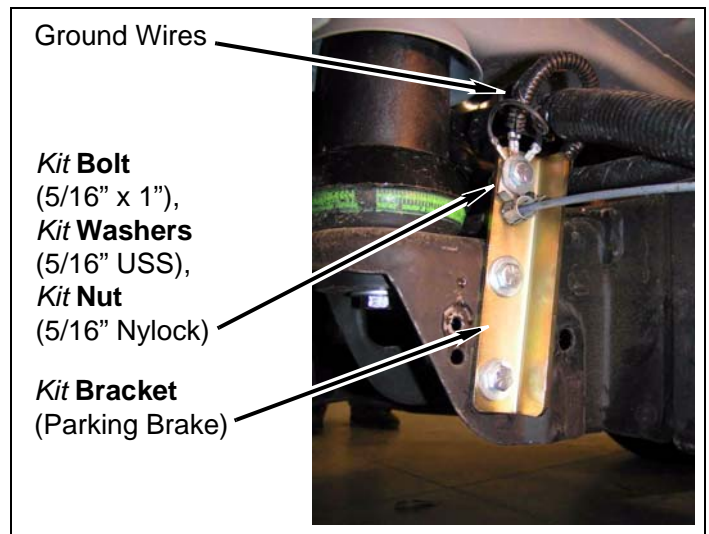

2. Parking brake cable

- a. Using **kit bracket** (parking brake) as a template, drill two 5/16" holes on frame driver side mounting pad as shown.

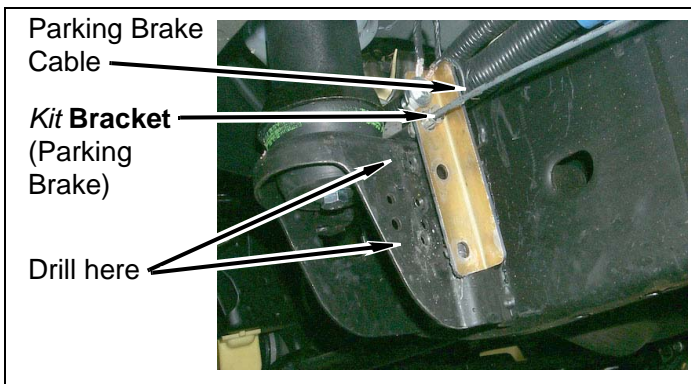

3. Wire harnesses

- a. Install wiring harness into clips on frame rail, if possible.

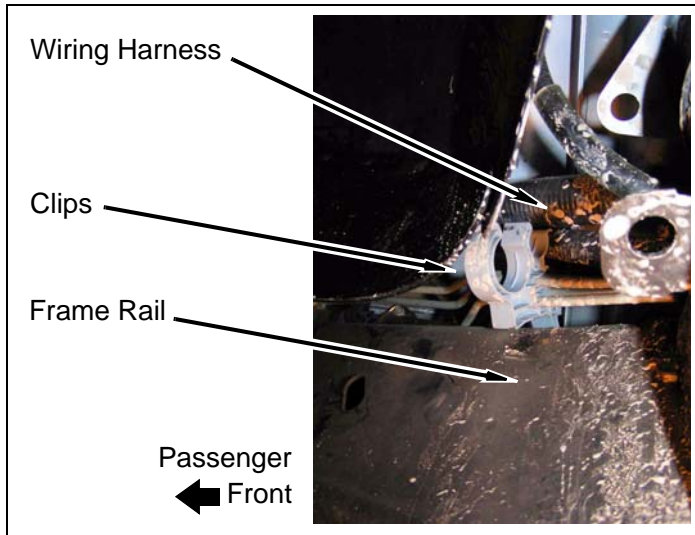

- b. Install wiring harness onto brake line, if possible.

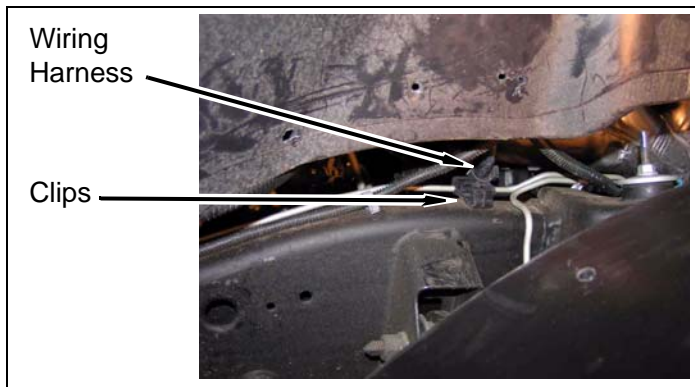

- c. Install wire clips to body and frame rail along passenger side, if possible.

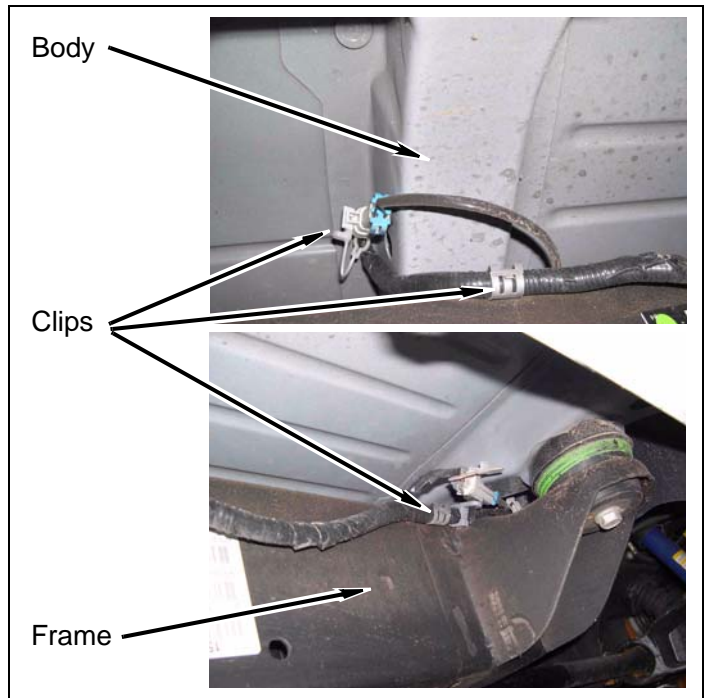

Inside of Vehicle

- 1. Manual transmission shift lever

- a. Rotate *kit extension* until it is in best position for shifting (about 45° from centerline of transmission). Install *kit extension* (SE4701) on input lever. Tighten jam nut.

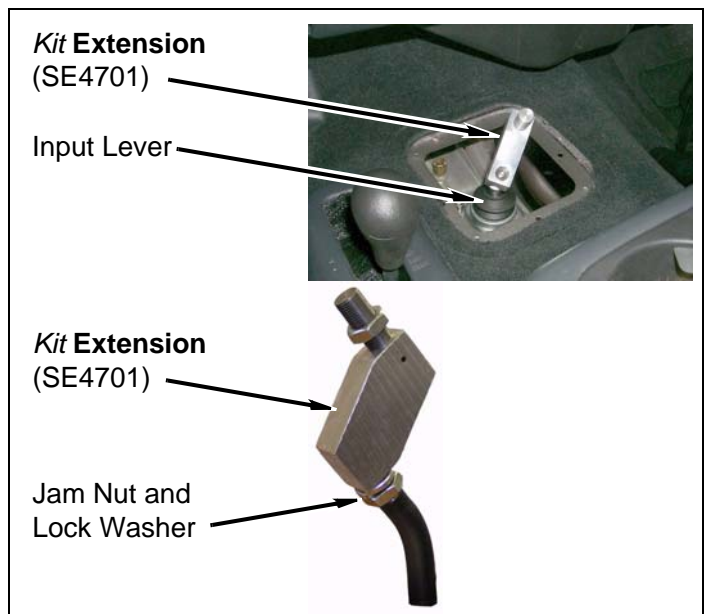

- b. Install shift lever on *kit extension*. Tighten jam nut.

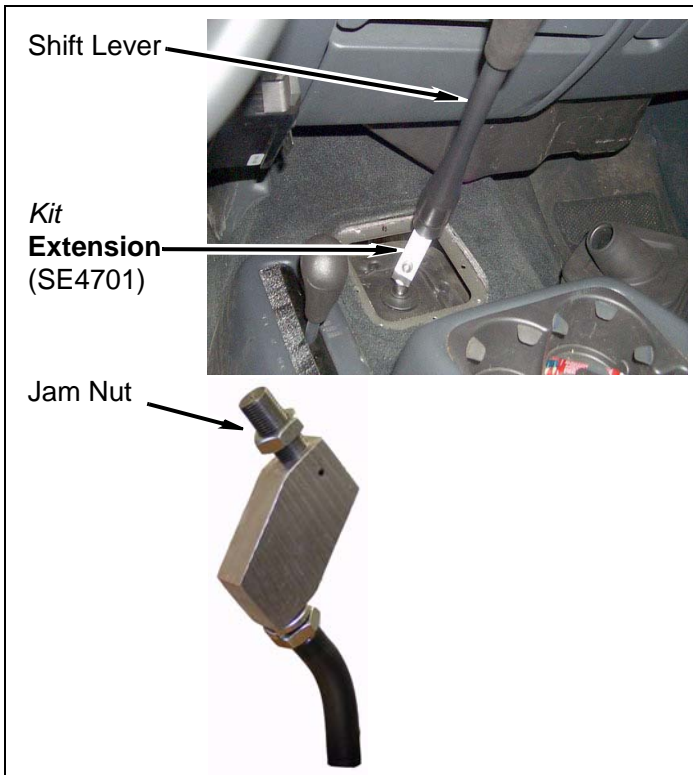

- c. Check transmission shift lever operation. Ensure there is complete engagement in all gears.
- d. Install shift boot on floorboard with four screws. Check transmission shift lever operation again.

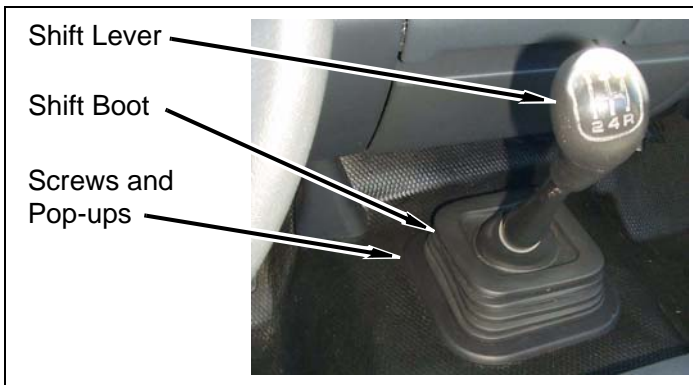

Engine Compartment

- 1. Steering shaft



⚠ WARNING

Verify the steering extension is securely installed as specified in the instructions. Failure to do so may cause steering malfunction, resulting in property damage or serious personal injury.

- a. Install *kit extension* (steering) in position on upper steering shaft with *kit bolt* (3/8" x 1-3/4"), two *kit washers* (3/8" SAE) and *kit nut* (3/8" Nylock). DO NOT TIGHTEN. Ensure marks on upper steering shaft and lower steering shaft are aligned.

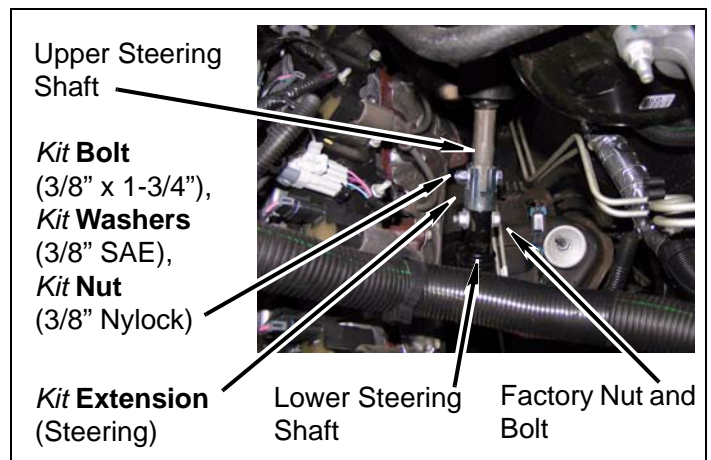

- b. Install lower steering shaft on *kit extension* (steering) with factory bolt and nut, ensuring marks on upper steering shaft and lower steering shaft are aligned. DO NOT TIGHTEN.
- c. Apply a few drops of Loctite® to threads of factory bolt and *kit bolt* (3/8" x 1-3/4").
- d. Install and tighten bolts.

2. Ground strap

- a. Install **kit bracket** (ground strap) to factory post with factory nut. Install ground strap to **kit bracket** (ground strap) with **kit bolt** (1/4"-20 x 1"), two **kit washers** (1/4" SAE) and **kit nut** (1/4"-20 Nylock).

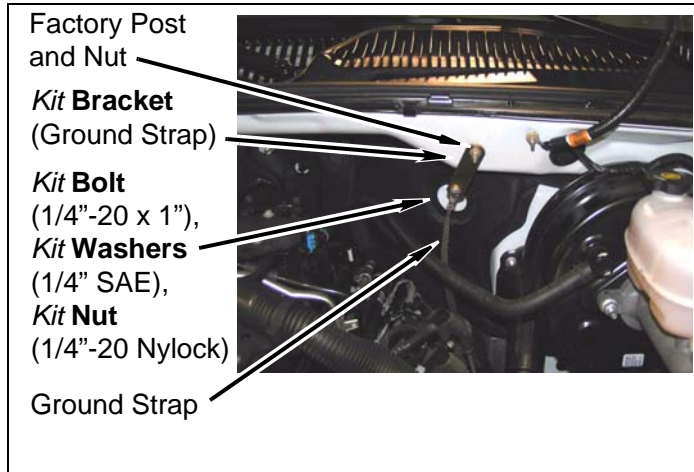

- b. Install **kit plates** with two **kit bolts** (1/4"-20 x 1"), four **kit washers** (1/4" SAE) and two **kit nuts** (1/4" nylock). DO NOT TIGHTEN.

NOTE:

Kit plate (right block off) with notch cut-out is installed on passenger side.

2" Kit: When installing **kit plates** on core support, use four top holes. The two middle holes are for **kit loom** (wire) and pre-assembly.

3" Kit: When installing **kit plates** on core support, use two middle holes and install two **kit loom** (wire) in same location.

- c. Position two **kit loom** (wire) on wiring harness as shown.
- d. Position **kit plate** assembly and two **kit loom** (wire) on core support with four **kit bolts** (1/4"-20 x 1"), four **kit washers** (1/4" SAE) and four **kit nuts** (1/4" nylock). DO NOT TIGHTEN. Ensure lip of **kit plate** assembly is pointing forward as shown.

3. **Electric fan:** Radiator

- a. No procedures required.

4. **Mechanical fan:** Radiator

- a. Assemble **kit plate** (left block off), **kit plate** (middle block off) and **kit plate** (right block off), ensuring lip of each **kit plate** is aligned with other **kit plates**.

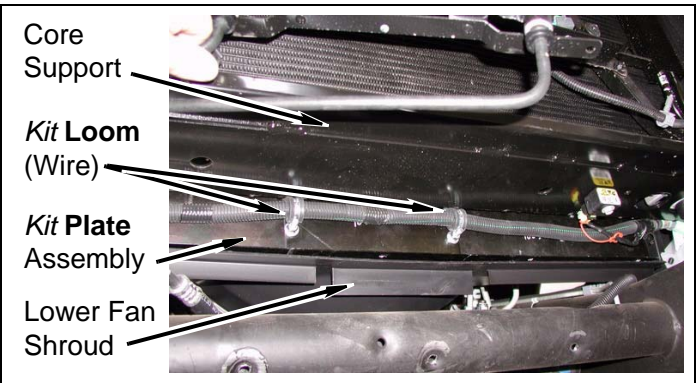
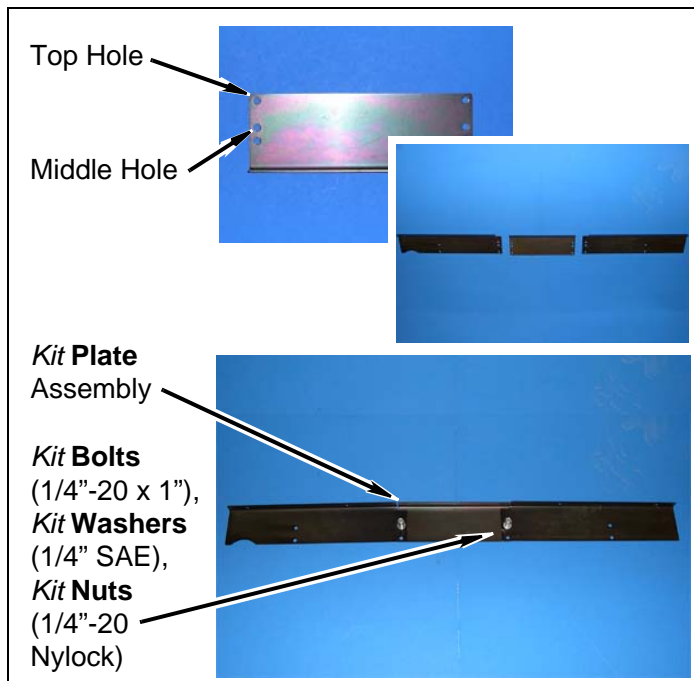

- e. Position fan on fan clutch with four bolts. DO NOT TIGHTEN.

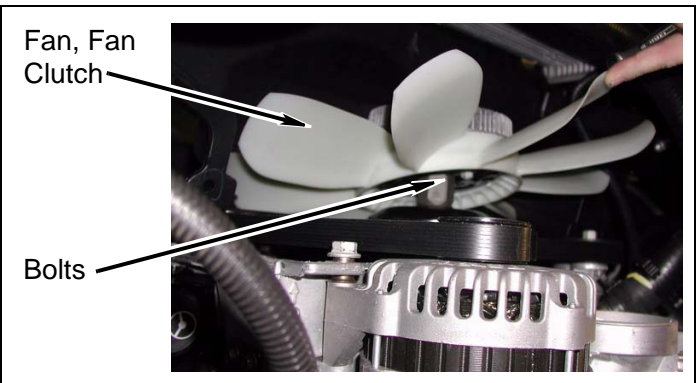

NOTE:

For easier positioning of lower **kit plate** assembly to lower fan shroud:

1. Install **kit brackets** (radiator) on upper fan shroud.
2. Install upper fan shroud along with lower fan shroud to core support.

- f. Position and center lower fan shroud on **kit plate** assembly. Mark position of lower fan shroud **kit plate** assembly in relation to lower fan shroud. Ensure lower fan shroud will not come in contact with fan.

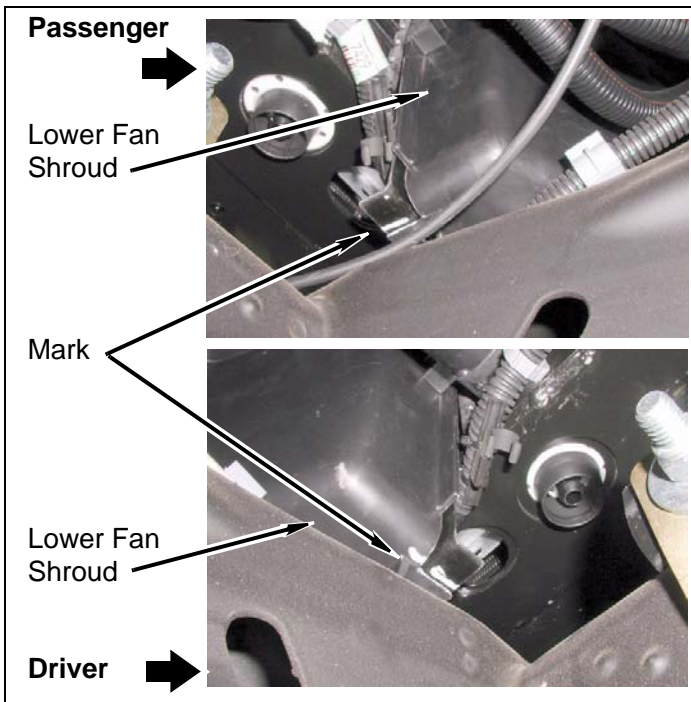

- g. Remove four bolts and fan from fan clutch. Rest fan on fan clutch shaft.

NOTE:

For assistance holding **kit plate** assembly square, install a second **kit bolt** (1/4"-20 x 1") to the **kit plate** assembly.

- h. Remove lower fan shroud and **kit plate** assembly from vehicle and position together as shown. Continue marking fan shroud as shown. Trim fan shroud where marked.

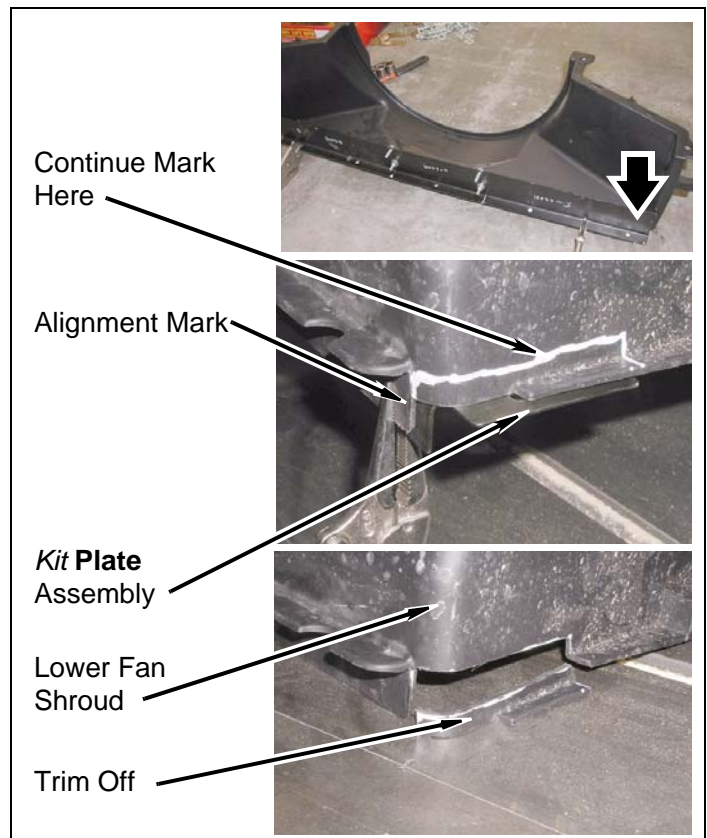

- i. Position lower fan shroud and **kit plate** assembly together as marked. Using **kit plate** assembly as a template, drill five 1/4" holes.

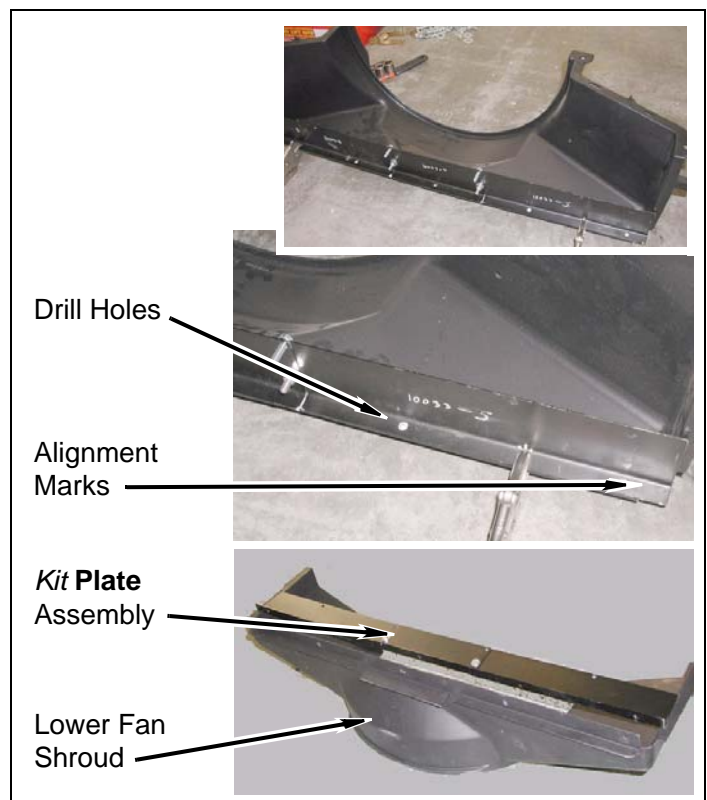

- j. Trim locking tabs and marked edges from driver and passenger fan shroud as shown.

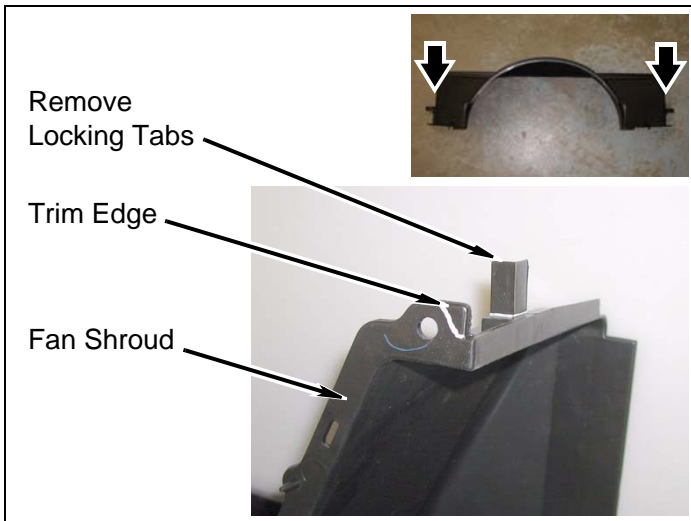

- k. Using lower fan shroud as a template, mark upper fan shroud. Trim marked edges from upper fan shroud to coincide with lower fan shroud as shown.

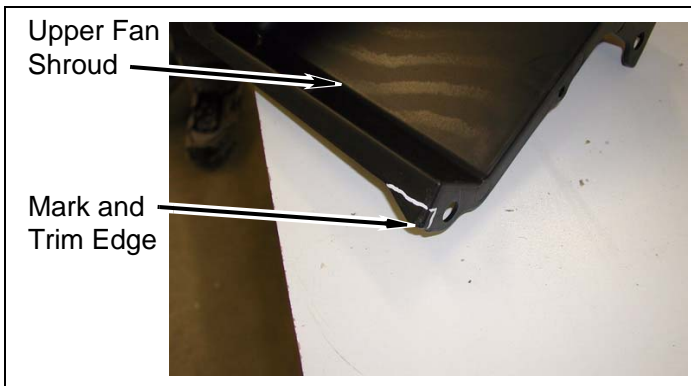

- l. Position and rest lower fan shroud in engine compartment.

- m. Install **kit plate** assembly and two **kit loom** (wire) on core support with four **kit bolts** (1/4"-20 x 1"), four **kit washers** (1/4" SAE) and four **kit nuts** (1/4" nylock).

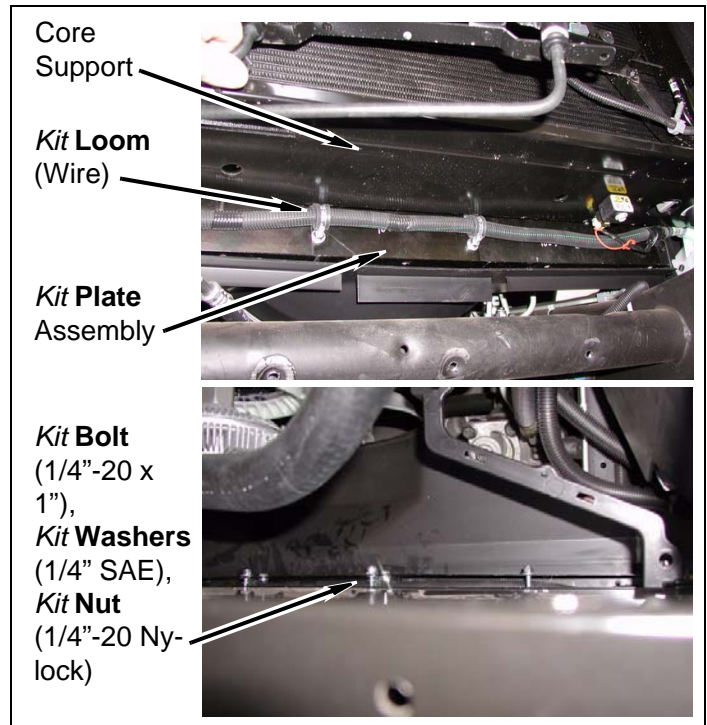

- n. Install lower fan shroud on **kit plate** assembly with three **kit bolts** (1/4"-20 x 1"), six **kit washers** (1/4" SAE), three **kit nuts** (1/4" nylock) and two **kit clips** (push).

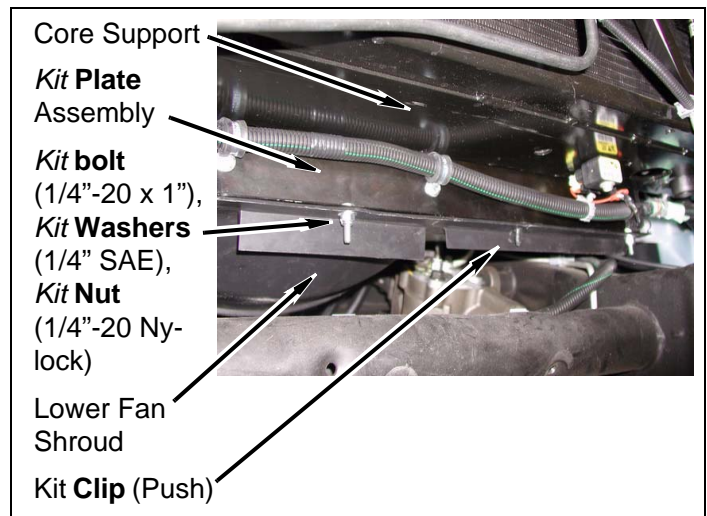

- o. Install fan on fan clutch with four bolts.

- p. **2" kit**: trim upper lip from upper fan shroud as shown.

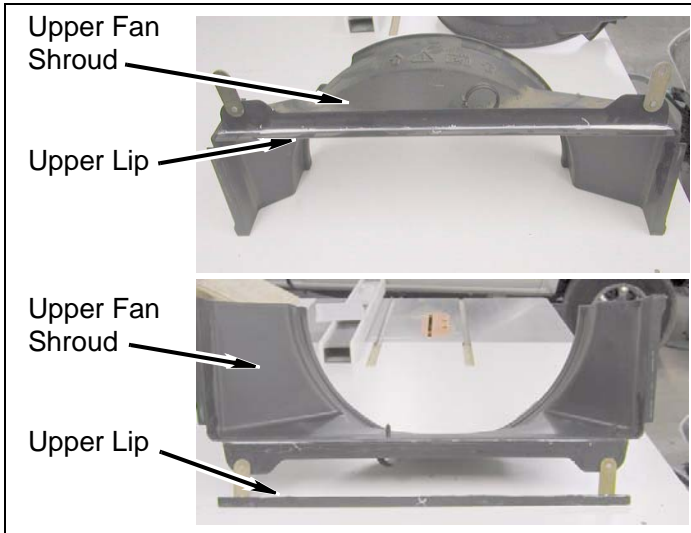

- q. Remove two bolts from radiator and upper core support.

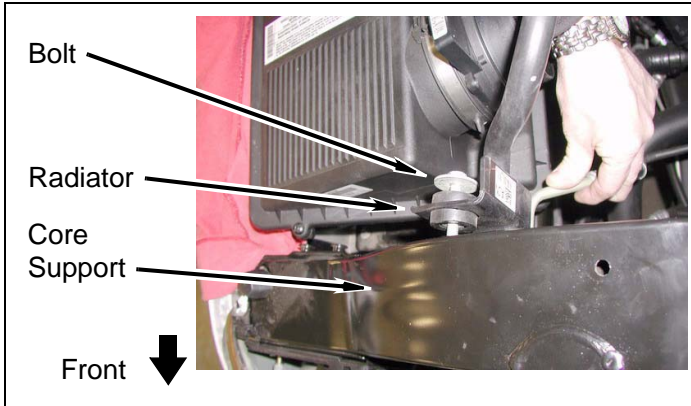

- r. Assemble **kit cover** (upper fan shroud block off), upper fan shroud and two **kit brackets** (radiator) with two **kit washers** (1/4" SAE) and two **kit nuts** (1/4" nylock).

- s. Drill upper fan shroud using **kit cover** (upper fan shroud block off) as a template. Drill with a 1/4" drill bit and install a **kit clip** (push) as shown with a **kit washer** (1/4" SAE).

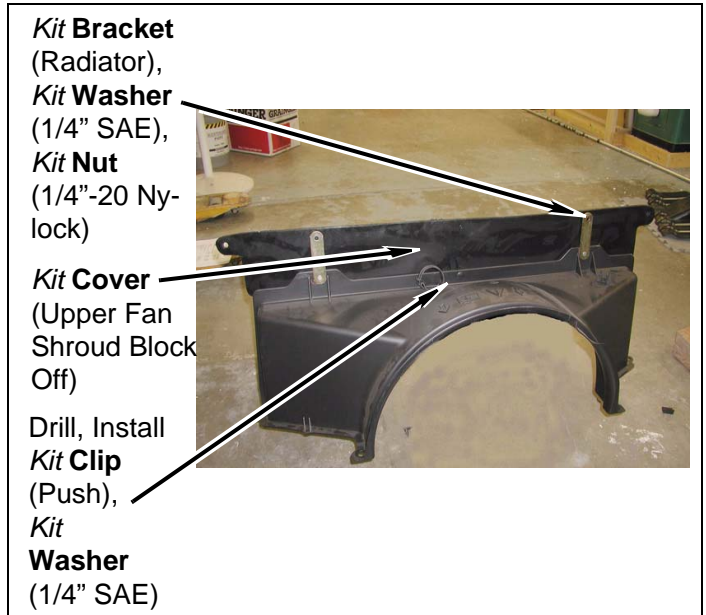

- t. Install upper fan shroud assembly on core support, radiator and lower fan shroud with four bolts. Ensure **kit cover** (upper fan shroud block off) is placed in between core support and radiator.

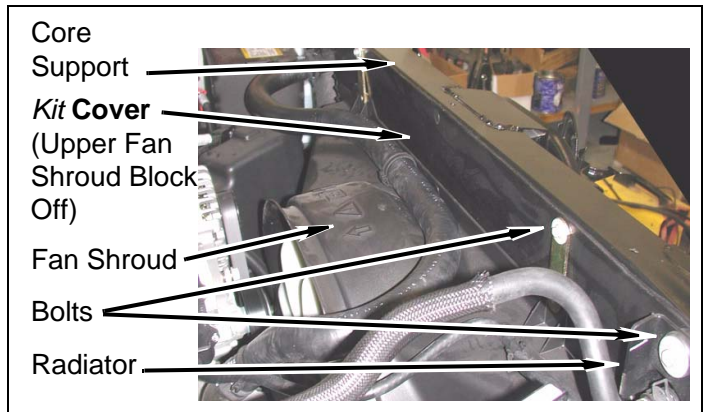

- u. Attach upper fan shroud to lower fan shroud with four pop-ups on sides of fan shroud.

NOTE:
Ensure all safety and care precautions are taken when operating power tools.

- v. Using **kit cover** (upper fan shroud block off) as a template, drill a 1/4" hole in core support and install a **kit clip** (push) as shown.

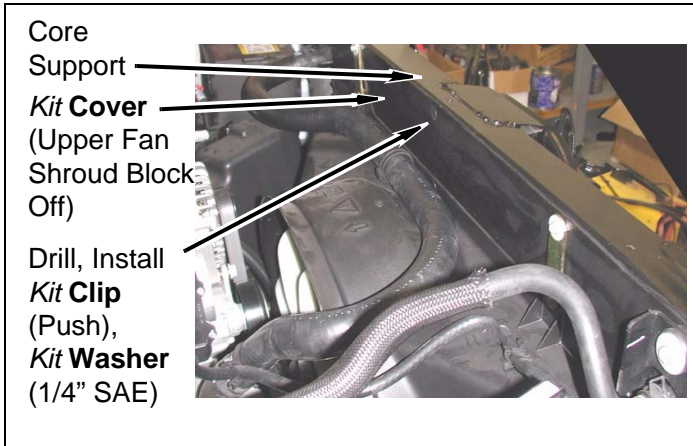

- w. Check fan to fan shroud clearance. Ensure gap is uniform around shroud and tighten all nuts and bolts.

5. Engine

- a. Position engine air intake hose on throttle body and airbox.

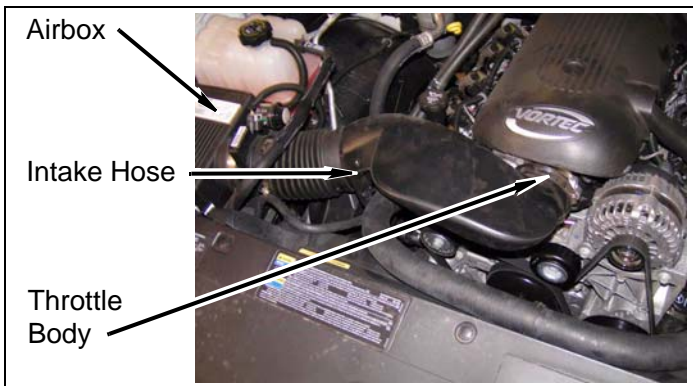

- b. Install radiator hoses to engine air intake hose with clips.

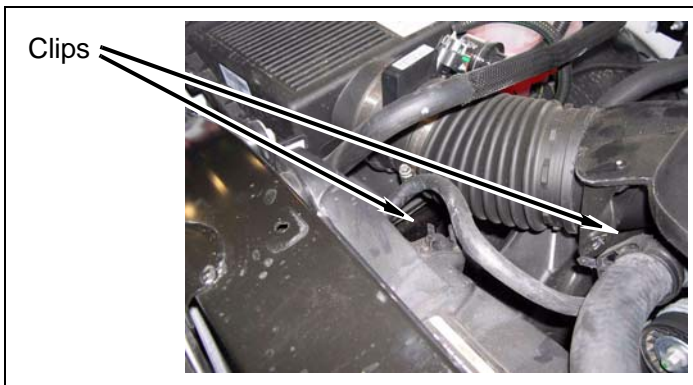

- c. Tighten engine air intake hose clamps.

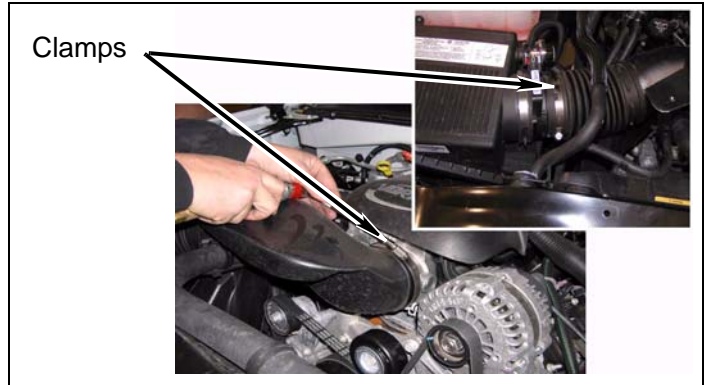

- d. Install engine cover and factory bolt to engine.

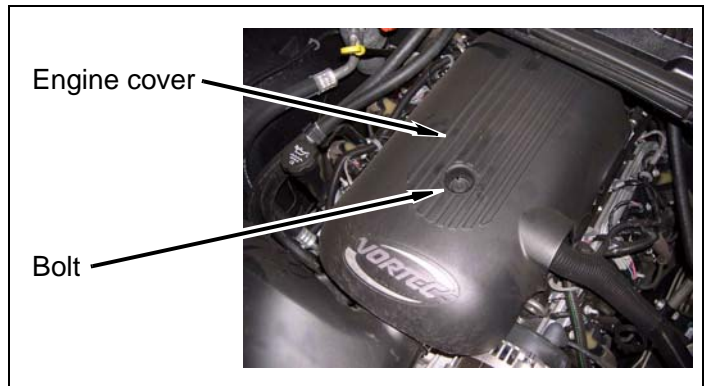

- e. Install radiator hose clip.

- f. Install radiator hose to radiator with clip.

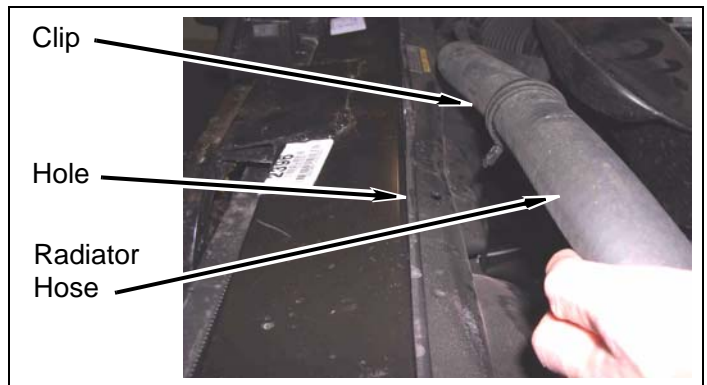

- g. Install heater hoses into clip.

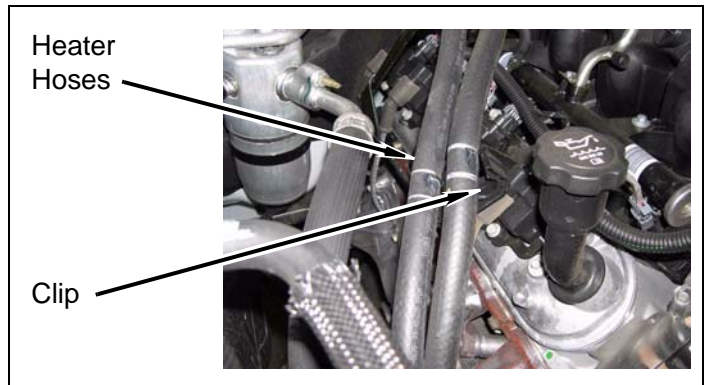

h. Install wiring harness into wire clip.

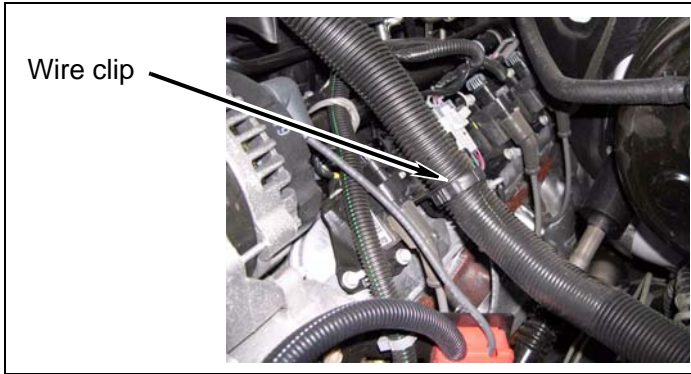

b. Install two **kit bracket** (2" S-shaped) onto clip nuts on core support with factory bolts. DO NOT TIGHTEN.

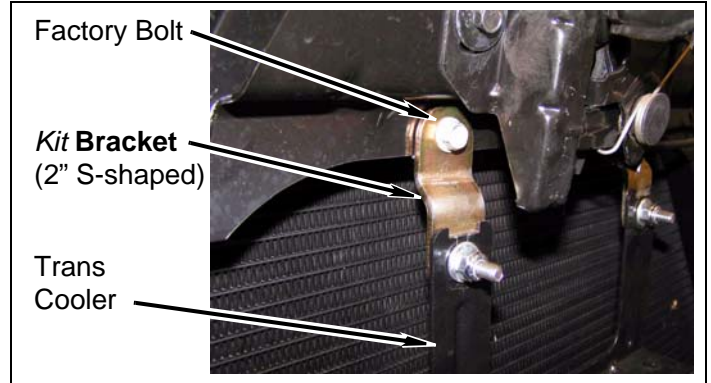

Front of Vehicle

1. Ground straps

a. Install ground straps to front cab mounting pads using factory bolts.

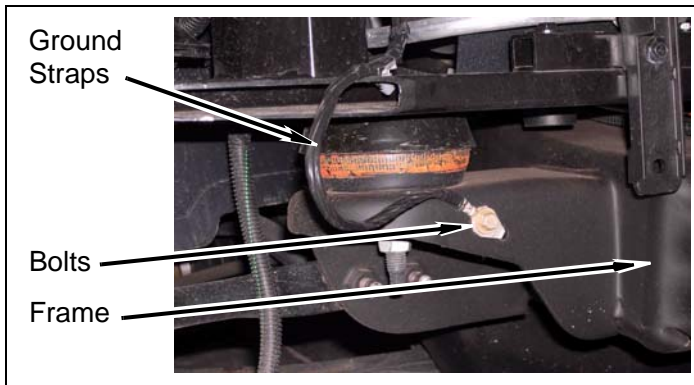

c. Install transmission cooler on two **kit brackets** (2" S-shaped) with **kit washer** (1/4" SAE) and **kit nut** (1/4"-20 Nylock). DO NOT TIGHTEN.

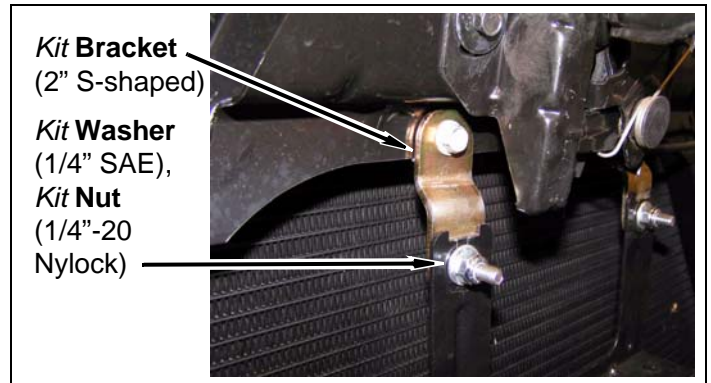

2. Transmission cooler

a. Remove two clip nuts from top of transmission cooler and install onto core support.

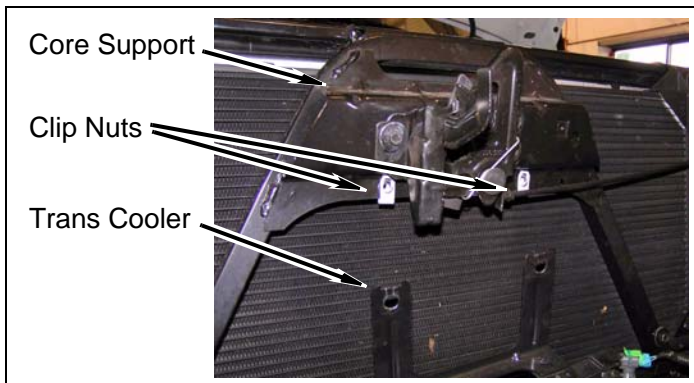

d. Install transmission cooler to core support bracket with two **kit spacers** (2" x .5 ID x .59 OD) with two **kit bolts** (1/4"-20 x 3"), four **kit washers** (1/4" SAE) and two **kit nuts** (1/4"-20 Nylock). DO NOT TIGHTEN.

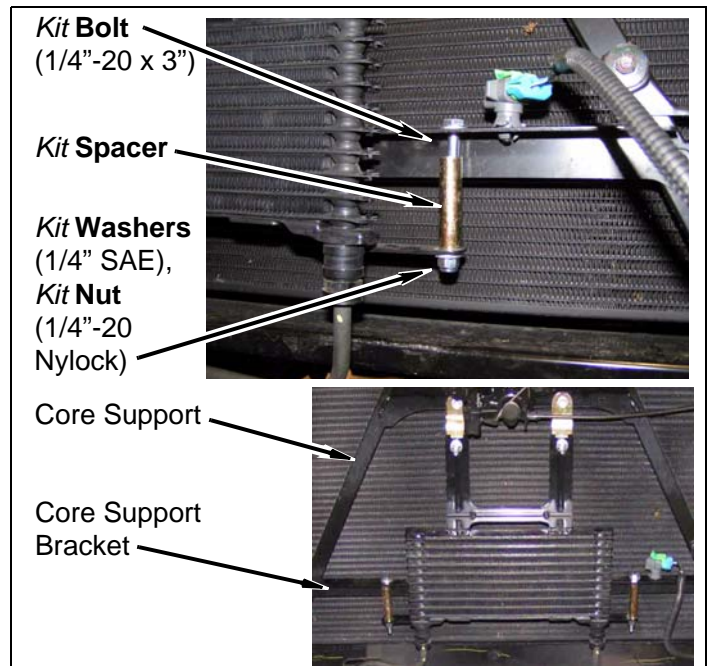

- e. Adjust transmission cooler and position transmission cooler lines in factory clips.

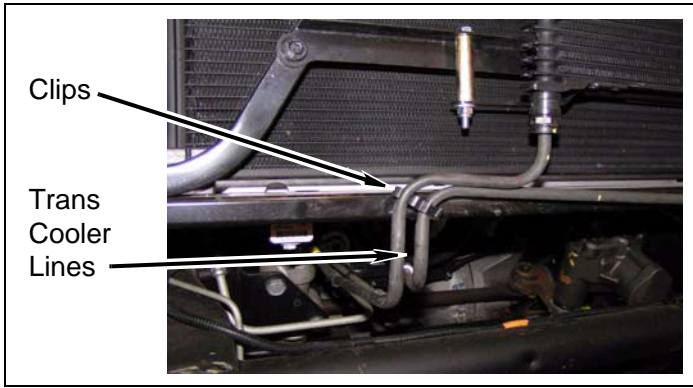

- f. Tighten all hardware.

3. Install air flap with push clips into corresponding holes on core support.

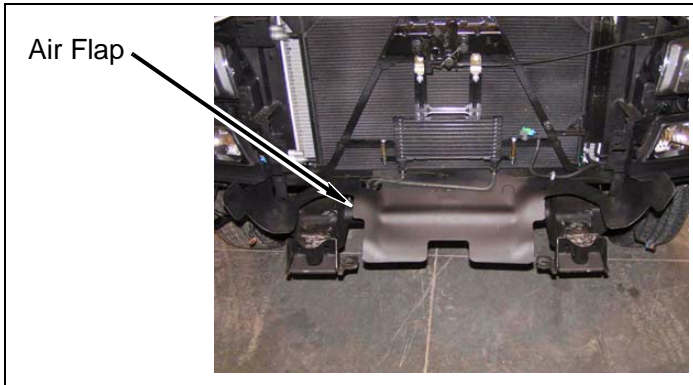

4. Install lower guard to core support and frame with factory bolts.

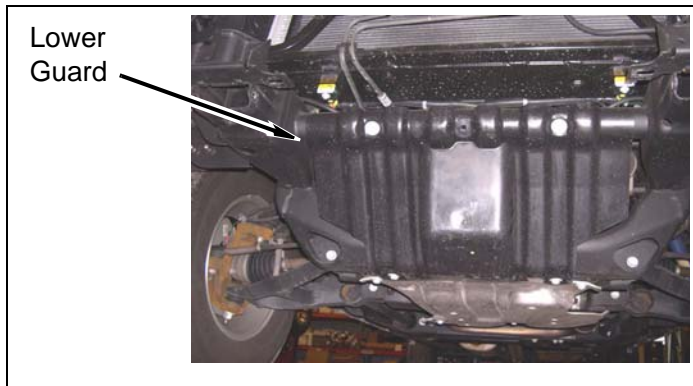

5. Front bumper

- a. Install **kit bracket** (front bumper, driver) on frame with factory bolt. Apply a few drops of **kit Loctite®** to factory front bumper bolt. **DO NOT TIGHTEN.**

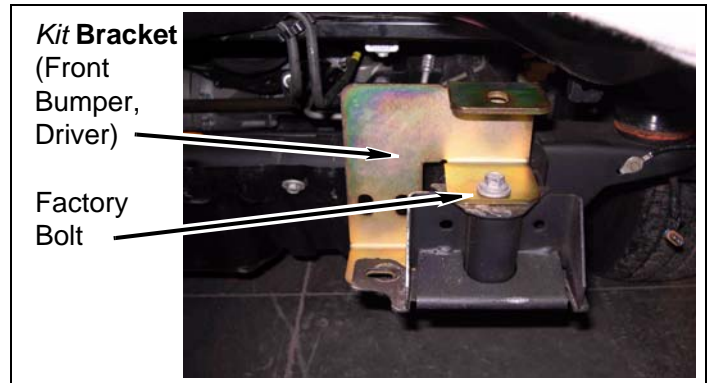

- b. Install **kit bracket** (front bumper, inner driver) to **kit bracket** (front bumper, driver) and frame with three **kit bolts** (7/16" x 1-1/2"), six **kit washers** (7/16" USS) and three **kit nuts** (7/16" Nylock). **DO NOT TIGHTEN.**

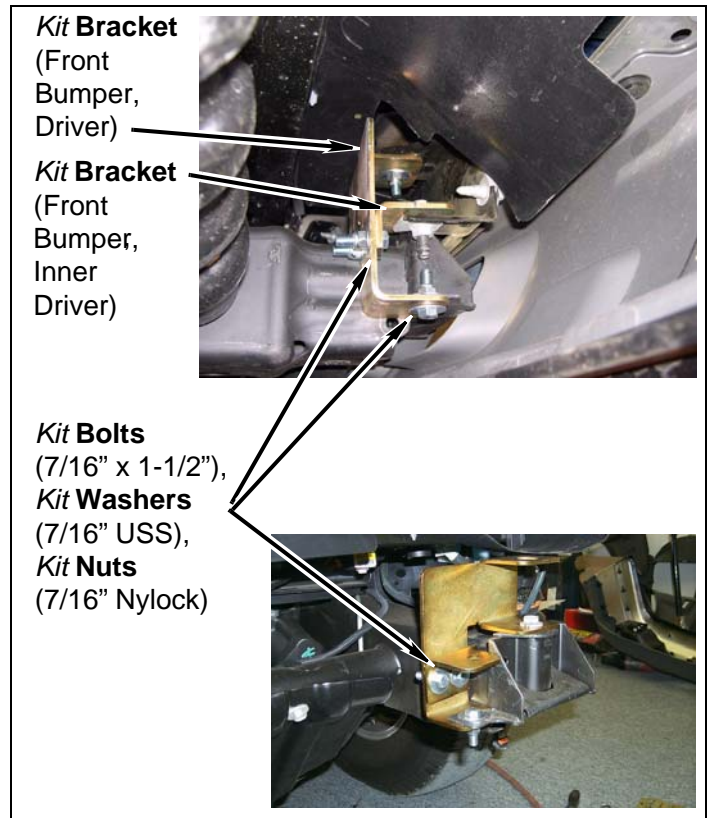

- c. Repeat above steps for passenger side of vehicle.

d. Trim driver and passenger front bumper brackets as shown.

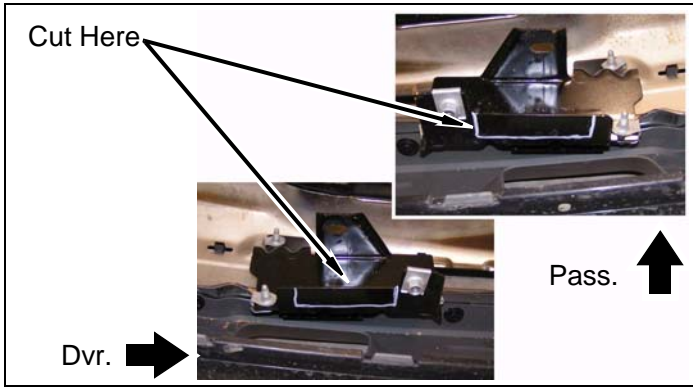

e. **GMC models:** Trim driver and passenger bumper tow hook openings as shown.

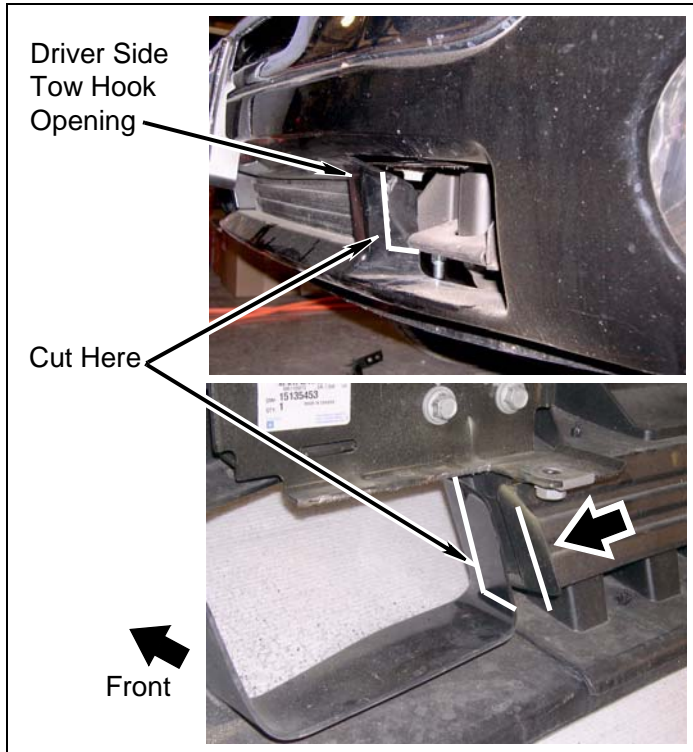

f. **GMC models:** Test fit bumper on vehicle and re-trim bumper, if necessary.

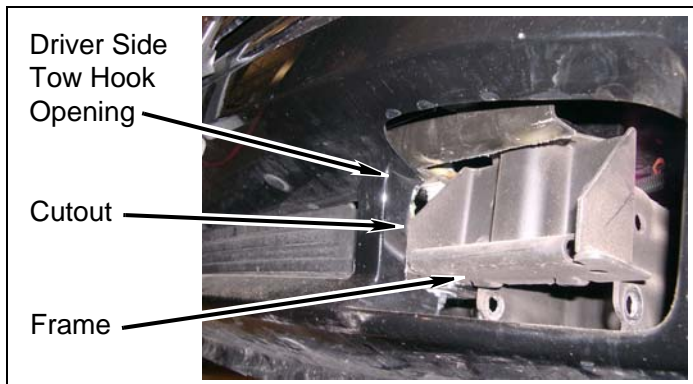

g. Install front bumper to **kit brackets** (front bumper) and **kit brackets** (front bumper, inner) with two factory bolts and nuts, and two **kit bolts** (7/16" x 1-1/2"), four **kit washers** (7/16" USS) and two **kit nuts** (7/16" Nylock). Apply a few drops of **kit Loctite®** to threads of factory bolts. **DO NOT TIGHTEN.**

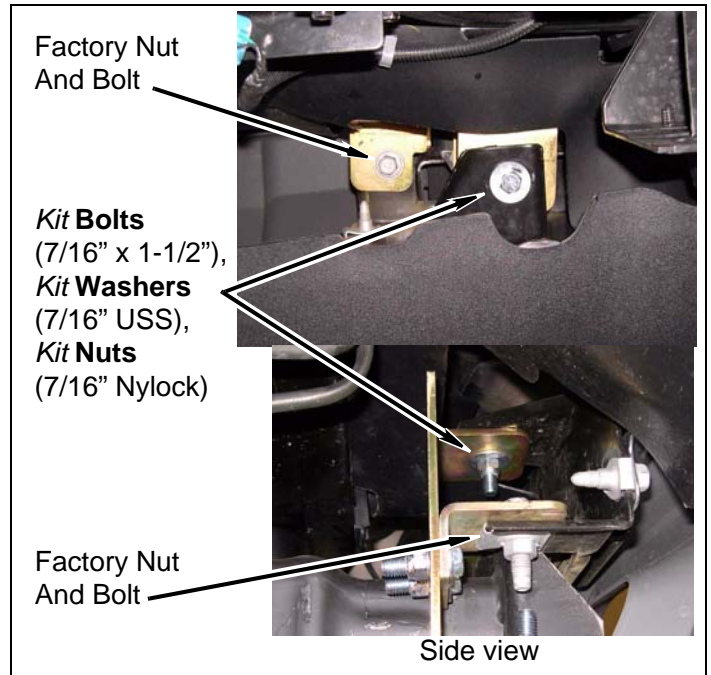

h. **2" kit:** Install passenger side front outer bracket to front bumper with factory bolt.

i. **2" kit:** Using passenger side front outer bracket as a template, drill two 1/2" holes through body mounting pad on frame.

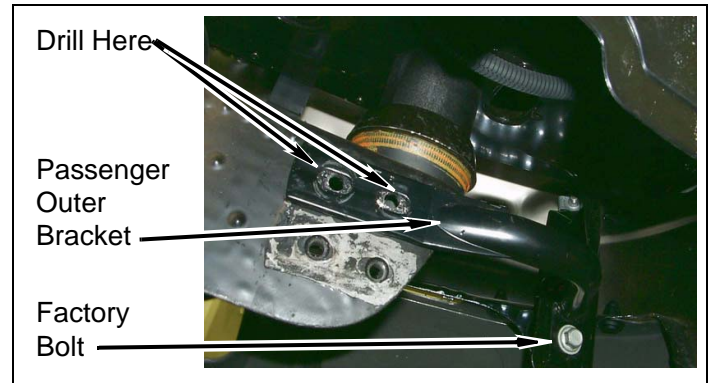

- j. **2" kit:** Install passenger side outer bracket to frame with two **kit bolts** (7/16" x 1-1/2"), four **kit washers** (7/16" USS) and two **kit nuts** (7/16" Nylock). DO NOT TIGHTEN.

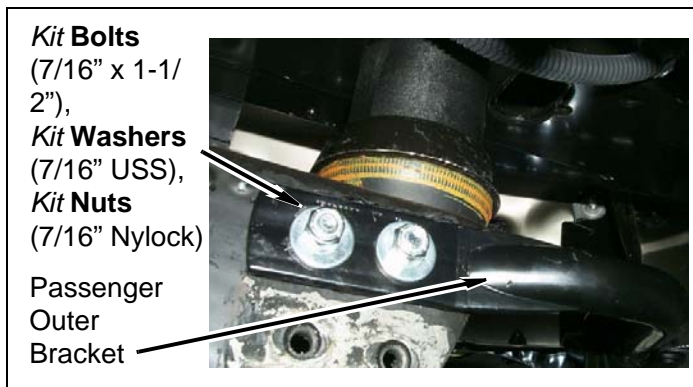

- k. **2" kit:** Repeat above steps for driver side of vehicle.
- l. **3" kit:** Install **kit bracket** (front bumper, outer) onto passenger side frame with factory bolts. Apply a few drops of **kit Loctite®** to threads of factory bolt. DO NOT TIGHTEN.

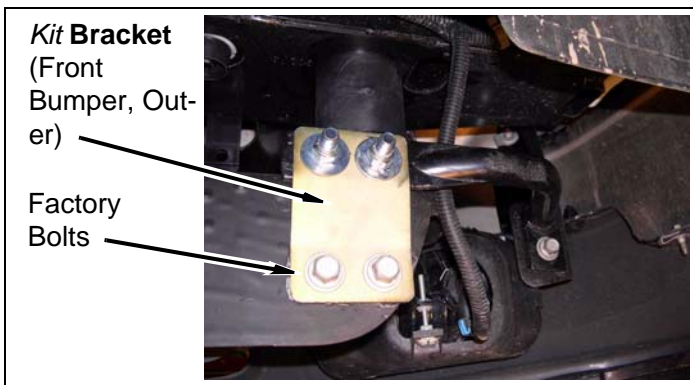

- m. **3" kit:** Install front outer bracket to **kit bracket** (front bumper, outer) with two **kit bolts** (7/16" x 1-1/2") four **kit washers** (7/16" USS) and two **kit nuts** (7/16" Nylock). DO NOT TIGHTEN.

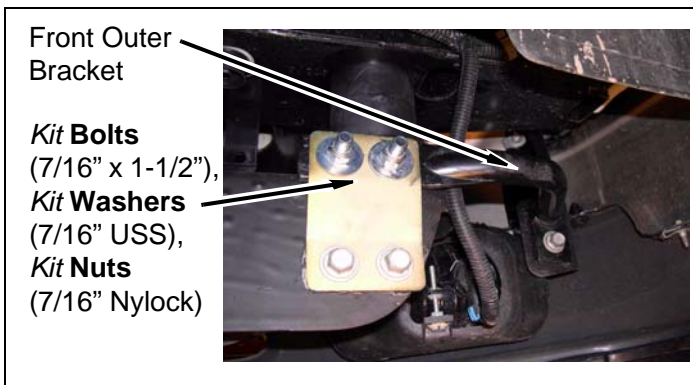

- n. **3" kit:** Apply a few drops of **kit Loctite®** to threads of factory bolt. Install front outer bracket to front bumper with factory bolt. DO NOT TIGHTEN.

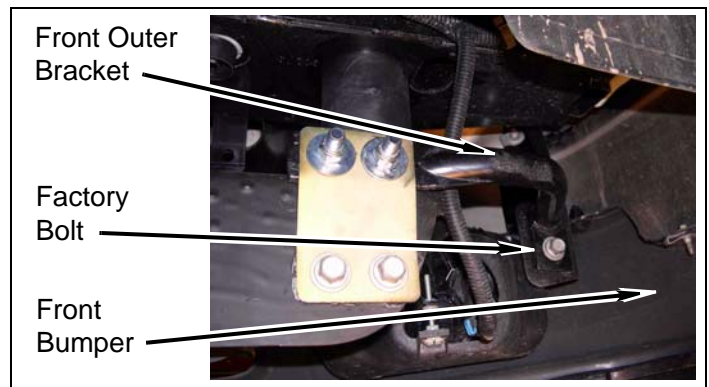

- o. **3" kit:** Repeat above steps for driver side of vehicle.
- p. Install two wire connectors onto fog lamps, if equipped.

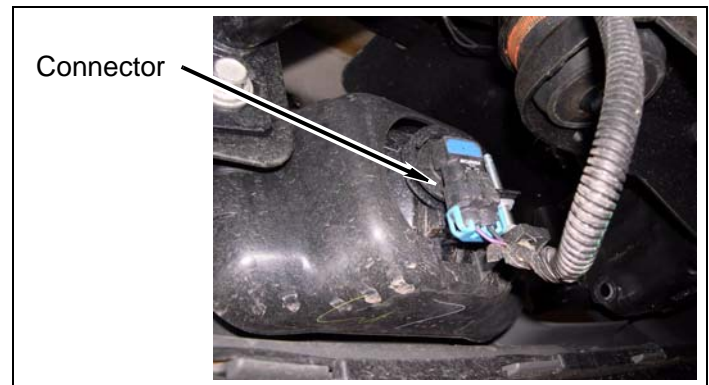

- q. Adjust bumper-to-fender measurement.
- r. Tighten all hardware.

After Completing Installation

Engine Compartment

1. Install airbag fuse and fuse block cover.

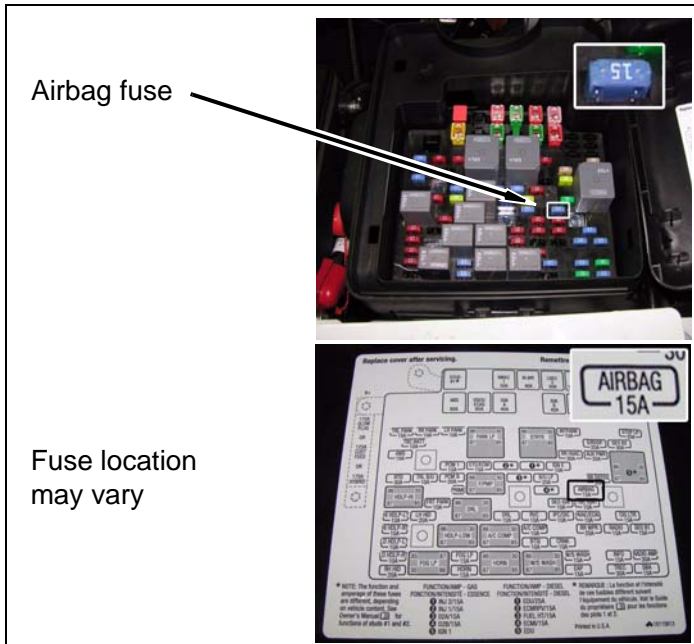

2. Connect both battery cables. Connect positive cable first, then negative cable.

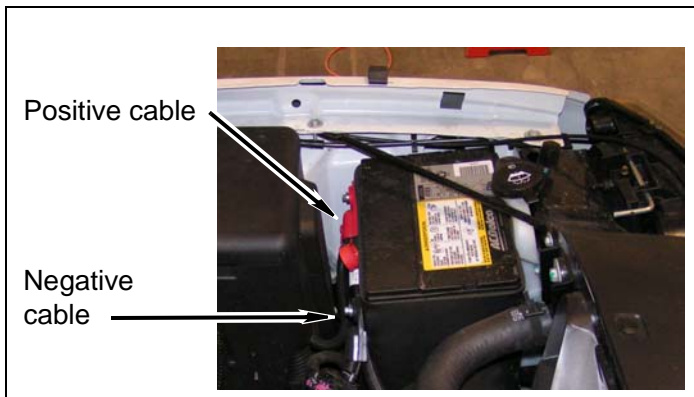

Miscellaneous

1. Apply *kit label* (warning) to dashboard in plain sight of all vehicle occupants.
2. Check all fasteners to ensure they are tight.
3. Ensure all wires, hoses, cables, etc. are properly connected and there is ample slack.

Dynamic Vehicle Check

1. Test-drive vehicle. Check steering in both directions to ensure that there is no bind. Check operation of clutch, brake system, and parking brake. Check operation of transmission and transfer case. Ensure there is full engagement in all gears and 4WD ranges. Check battery connections and electrical component operations.

⚠WARNING

Retorque all fasteners after 500 miles and after off road use. All body lift components should be visually inspected and fasteners retorqued during routine vehicle servicing.

⚠CAUTION

Performance Accessories does not recommend any particular wheel and tire combinations for use with its body lifts and cannot assume responsibility for the customer's choice of wheels and tires. Refer to your owner's manual for recommended tire sizes and warnings related to the use of oversized tires. Larger wheel and tire combinations increase stress and wear on steering and suspension components, which leads to increased maintenance and higher risk for component failure. Larger wheel and tire combinations also alter speedometer calibration, braking effectiveness, center of gravity, and handling characteristics. Consult an experienced local off road shop to find what wheel and tire combinations work best with your vehicle.

⚠NOTE

All warranty information, instruction sheets, and other documents regarding the installation of this product must be retained by the vehicle owner. Information contained in the instructions and on the warranty card will be required for any warranty claims. The vehicle owner needs to understand the modifications made to the vehicle and how they affect vehicle handling and performance. Failure to provide the customer with this information can result in damage to the vehicle and severe personal injury.

Accessories

The following accessories are also available:

Kit # 6543: Gap Guards

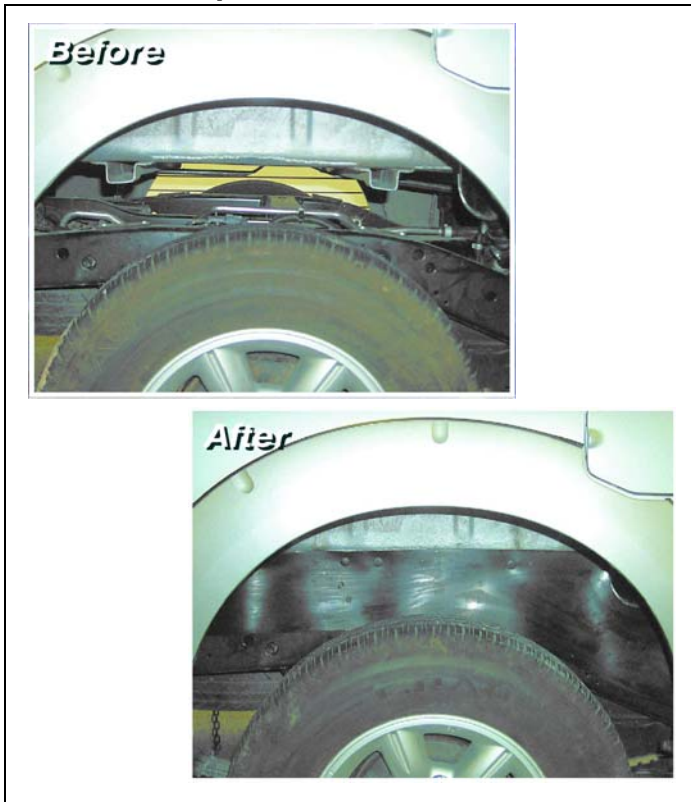

Kit Parts List

Qty. Description

Kit PA10132

2	Block , 2" x 2" spacer
2	Block , 2" x 2" spacer, drilled
14	Block , 2" x 3" spacer
4	Block , 2" crush
8	Bolt , 12mm-1.75 x 80mm
8	Bolt , 12mm-1.75 x 160mm
2	Bolt , 14mm-2.0 x 90mm
2	Bracket , 2" radiator
2	Nut , 1/2" nylock

Kit PA10133

2	Block , 3" x 2" spacer
2	Block , 3" x 2" spacer, drilled
14	Block , 3" x 3" spacer
4	Block , 3" crush
8	Bolt , 12mm-1.75 x 100mm
8	Bolt , 12mm-1.75 x 180mm
2	Bolt , 14mm-2.0 x 110mm
2	Bracket , 3" radiator
6	Nut , 1/2" nylock

Kit PA10132 and PA10133

15	Bolt , 1/4"-20 x 1"
2	Bolt , 1/4"-20 x 3"
4	Bolt , 3/8"-16 x 1-1/2"
4	Bolt , 5/16" x 3/4" hex head
1	Bolt , 3/8"-16 x 1-3/4"
3	Bolt , 5/16" x 1"
16	Bolt , 7/16" x 1-1/2"
2	Bracket , 2" S-shaped
1	Bracket , front bumper, driver
1	Bracket , front bumper, passenger
1	Bracket , front bumper, inner driver
1	Bracket , front bumper, inner passenger
2	Bracket , front bumper, outer
2	Bracket , ground strap
1	Bracket , ground strap w/ stud
1	Bracket , parking brake
1	Bracket , rear bumper, driver
1	Bracket , rear bumper, passenger
2	Bracket , rear bumper, three stud
2	Clamp , #20 hose
2	Clamp , #36 hose
5	Clip , push
1	Cover , upper fan shroud block off (urethane)
1	Extension , fuel filler, metal
1	Extension , fuel filler, rubber
1	Extension , steering

Qty. Description

1	Extension , transfer case linkage
1	Label , logo
1	Label , warning
1	Label , warning, rear bumper
1	Loctite ®, 6ml bottle
2	Loom , wire
20	Nut , 1/4" nylock
2	Nut , 14mm nylock
5	Nut , 3/8" nylock
3	Nut , 5/16" nylock
16	Nut , 7/16" nylock
1	Plate , left block off
1	Plate , middle block off
1	Plate , right block off
2	Spacer , 2" x .5" ID x .59" OD
1	Tie , zip
2	Washer , 1/2" thick
6	Washer , 1/2" USS
29	Washer , 1/4" SAE
4	Washer , 14mm
8	Washer , 3/8" USS
2	Washer , 3/8" SAE
10	Washer , 5/16" USS
48	Washer , 7/16" USS
2	Washer , square, 3/16" x 1-1/2" x 2-1/2"

NOTE

Depending on the vehicle configuration (automatic or manual transmission, 2WD or 4WD, cab length, bed length, etc.), model year, some parts may not be used.