



3651 N. Hwy 89
 Chino Valley, AZ 86323
 (928) 636-7080 • www.p-a-g.net

**2011 - 2014 CHEVY/GMC
 2500HD/3500HD
 GAS PICK-UP
 (New Body Style) - 3" BODY LIFT
 INSTALLATION INSTRUCTIONS
 KIT#10263**

⚠ WARNING
 Installation of a Performance Automotive Group body lift kit will change the vehicle's center of gravity and handling characteristics both on and off-road. You must drive the vehicle safely! Extreme care must be taken to prevent vehicle rollover or loss of control, which could result in serious injury or death. Avoid sudden sharp turns or abrupt maneuvers and always make sure all vehicle occupants have their seat belts fastened.

⚠ WARNING
 Before you install this kit, read and understand all instructions, warnings, cautions, and notes in this instruction sheet and in the vehicle owner's manual.

⚠ CAUTION
 Proper installation of this kit requires knowledge of the factory recommended procedures for removal and installation of original equipment components. We recommend that the factory shop manual and any special tools needed to service your vehicle be on hand during the installation. Installation of this kit without proper knowledge of the factory recommended procedures may affect the performance of these components and the safety of the vehicle. We strongly recommend that a certified mechanic familiar with the installation of similar components install this kit.

⚠ WARNING
 DO NOT combine suspension, body, or other lift devices. Use of vehicle with combined lifts may result in unsafe and/or unexpected handling characteristics.

⚠ WARNING
 This kit should only be installed on a vehicle that is in good working condition. Before you install the kit, thoroughly inspect the vehicle for corrosion or deformation of the sheet metal around the factory body mounts. If the vehicle is suspected to have been in a collision or misused, do not install this kit. Off-road use of your vehicle with this kit installed may increase the stress applied to the factory body mounts. We do not recommend that any vehicle with a body lift kit installed be involved in any extreme off-road maneuvers such as jumping. Failure to observe this warning may result in serious personal injury and/or severe damage to your vehicle.

⚠ WARNING
 Many states and municipalities have laws restricting bumper heights and vehicle lifts. Consult state and local laws to determine if the changes you intend to make to the vehicle comply with the law.

⚠ WARNING
 The installation of larger tires may reduce the effectiveness of the Braking System.

⚠ WARNING
 Always wear eye protection when operating power tools.

⚠ WARNING
 Before you install this kit, block the vehicle tires to prevent the vehicle from rolling.

⚠ WARNING
 Accidental deployment of the air bag can result in serious personal injury or death. To avoid accidental deployment during installation of the kit, the Supplemental Restraint System (SRS, or airbag) must remain deactivated. Do not allow anyone near the airbag during installation. Refer to the factory service manual or owner's manual for the recommended procedure to disable the SRS. After you install the kit, reactivate the SRS before driving the vehicle.

⚠ NOTE
 Performance Automotive Group recommends using the Loctite® supplied in the kit on the threads of all kit nuts and bolts unless specified otherwise in these instructions.

Before Starting Installation

⚠ NOTE

Kit parts are prefaced by the word kit and appear in **bold print**.

1. Carefully read all warnings and instructions completely before beginning.
2. Verify all parts have been received in this kit by checking the parts list at the end of this document.

⚠ NOTE

If parts are missing from kit, please be prepared to provide the following information:

1. **Name** of purchase location
 2. **Bar Code** on side of box
 3. **Date** above bar code
 4. **Date** inside box cover
 5. **Inspector #** from inside box cover
3. **Only install this kit on the vehicle for which it is specified.** If anytime during the installation you encounter something different from what is outlined in the instructions, call technical support at (928) 636-7080.
4. Special tools needed:
- a. Die grinder or similar tool capable of cutting metal.
5. Park the vehicle on a clean, dry, flat, level surface and block the tires so the vehicle cannot roll in either direction.

A. Engine compartment

1. Battery cables
 - a. Disconnect battery cables from both batteries. Disconnect two negative cables first, then two positive cables.

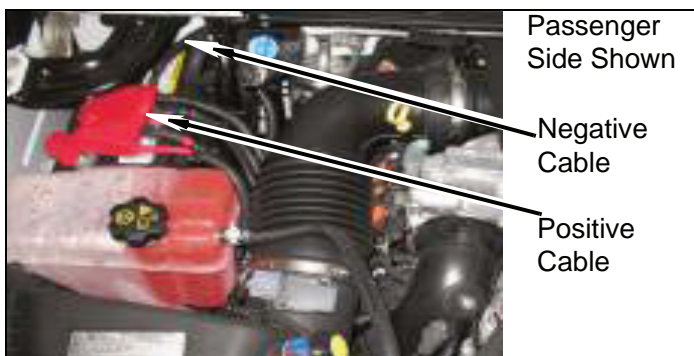

2. Airbag fuse
 - a. Remove cover and airbag fuse "SIR" from fuse panel. Fuse locations may vary. Check fuse chart on back of cover.



B. Measurements

1. Measure distance between the front bumper and front fenders. Record measurement.
Driver Side _____ Passenger Side _____
2. Measure distance between rear bumper and bed.
Driver Side _____ Passenger Side _____
3. Measure and record distance between cab and bed both sides.
Driver Side _____ Passenger Side _____

Prepare to install kit.

A. Front of vehicle

1. Grille
 - a. Remove cover from core support with seven push pins.

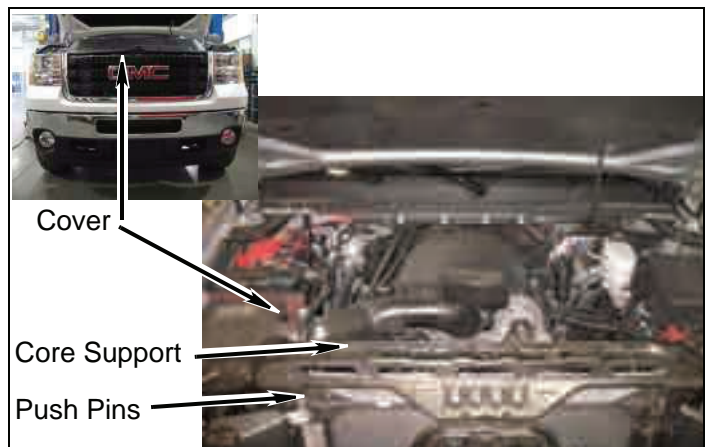

- b. Remove four bolts, six clips, and grille from core support. Some GMC models may have extra clips.



2. Front bumper

- a. If equipped, remove two connectors from two fog lamps.
- b. Remove six bolts and two front outer bumper braces from front bumper and frame.

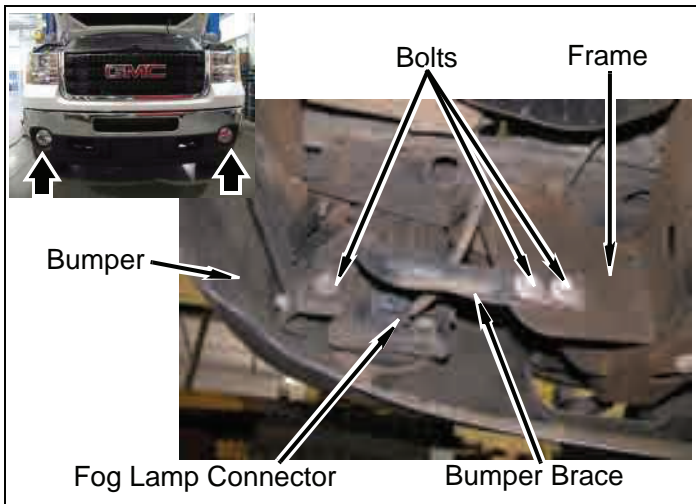

- c. Remove two bolts from each fender side and remove bumper face from core support and fenders.

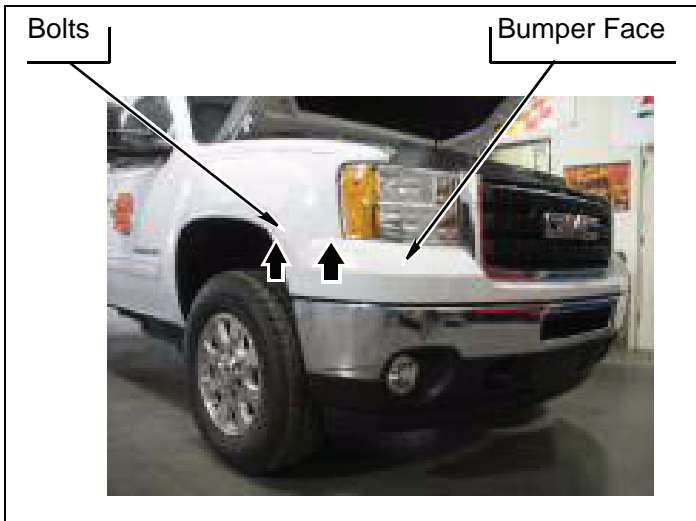

- d. Remove four nuts, two double-bolt fasteners and two frame brackets from two frame horns.

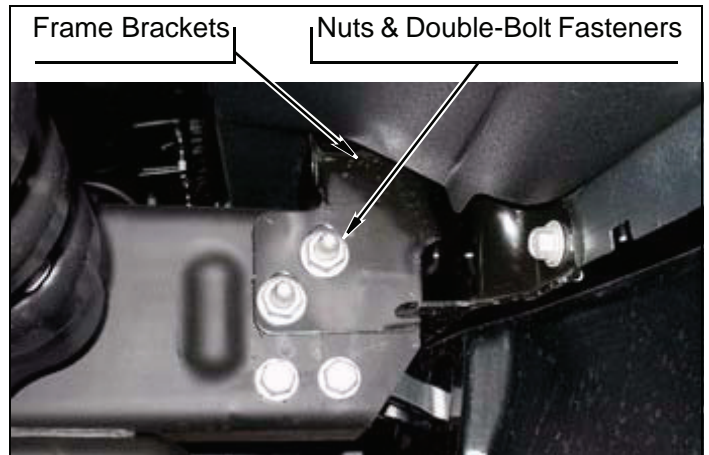

- e. Remove four bolts, two nuts and two tow hooks from frame horns.

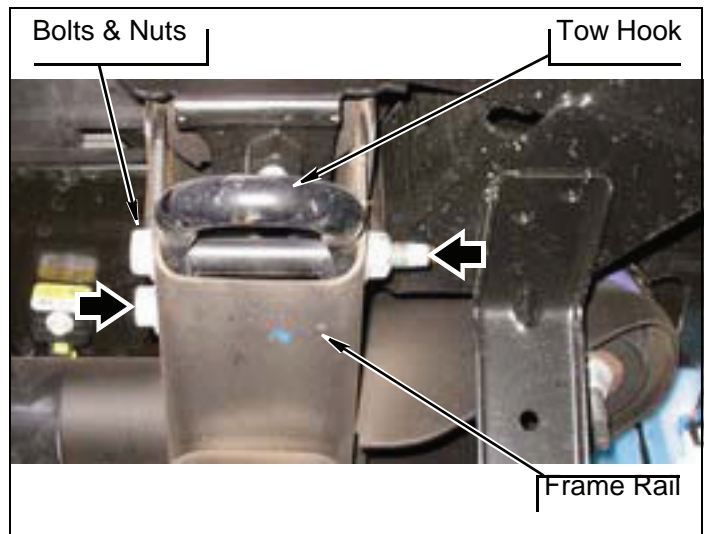

3. Plastic cover and air flap

- a. Remove five bolts, and plastic cover from frame and core support.

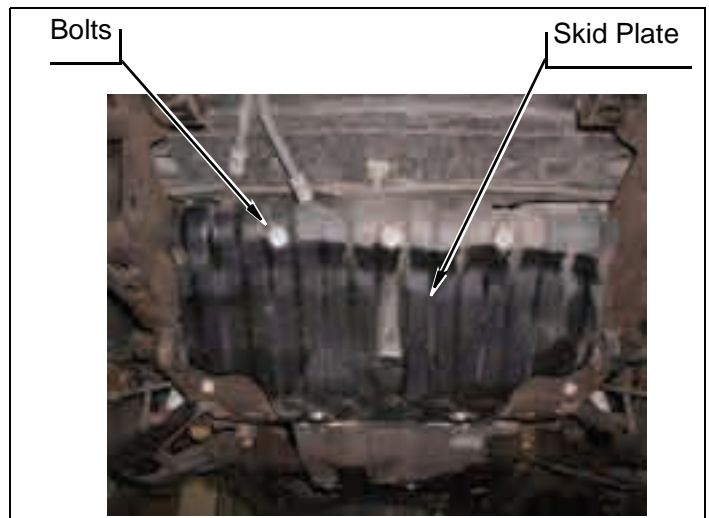

b. Remove plastic cover from push clip, lower radiator hose and vehicle.

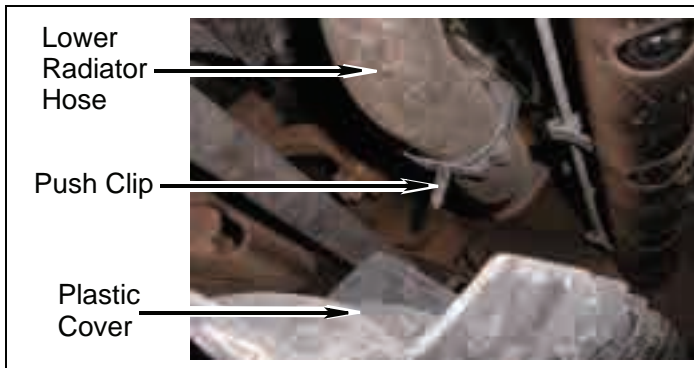

c. If equipped, remove clip and harness from air flap.

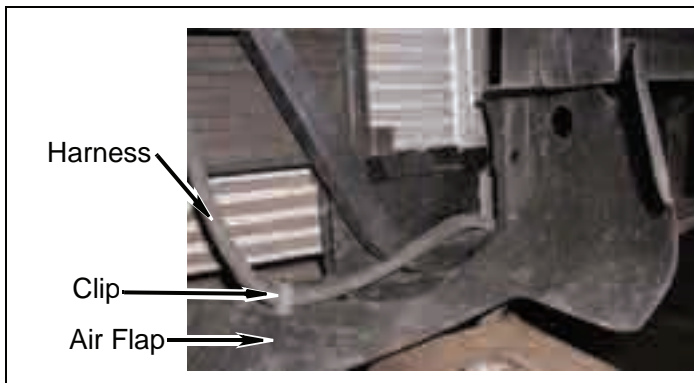

d. Remove two clips, three push pins, and air flap from core support.

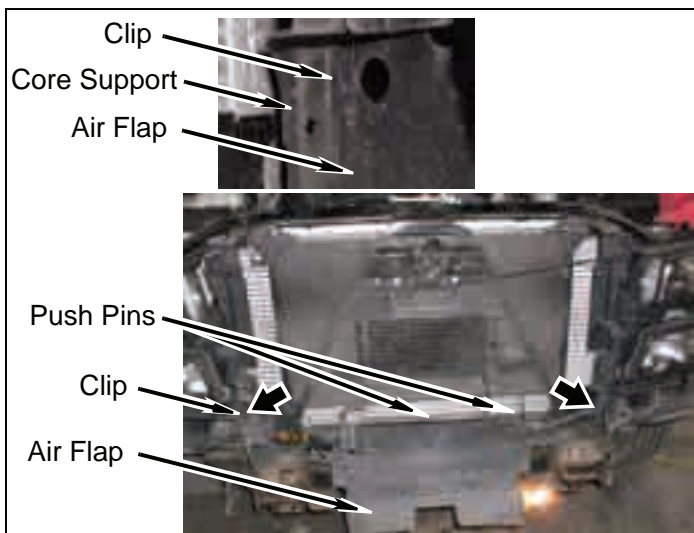

e. Remove front bumper from frame horns.

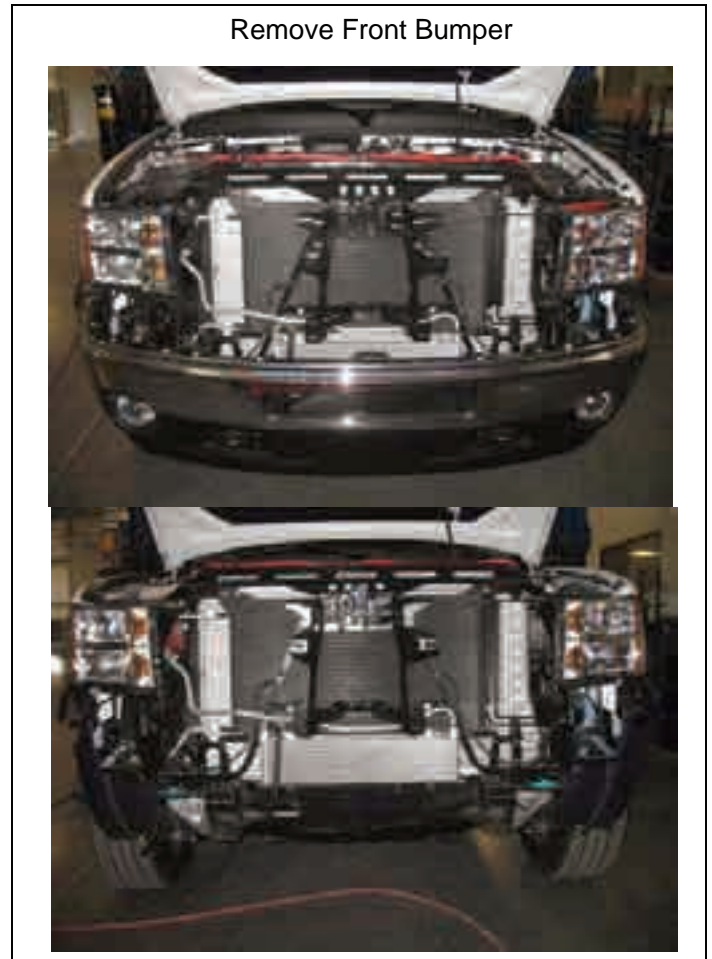

4. Transmission cooler

NOTE
Tie transmission cooler to core support so that it hangs free, and not binding hoses.

a. Remove two bolts and transmission cooler from core support.

b. Remove two gromits from transmission cooler.

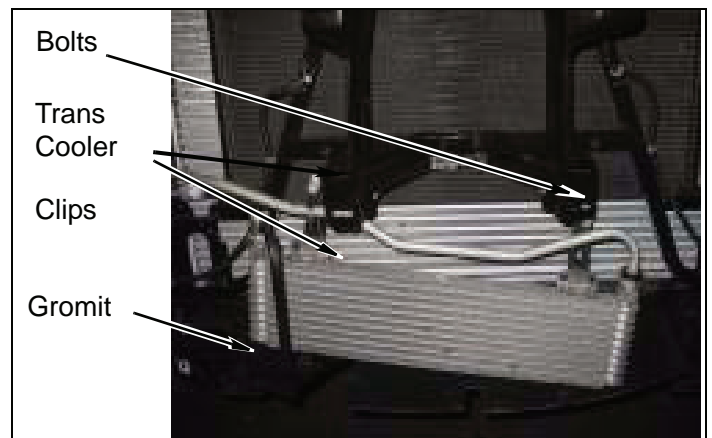

B. Engine Compartment

1. Air intake

- a. Loosen clamp from air baffle assembly. Remove wire harness clip from sensor.

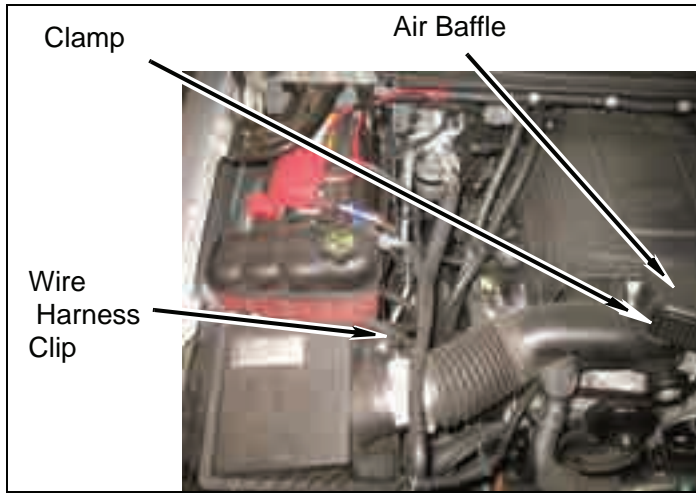

- b. Rotate air intake assembly away from engine and towards fender while pulling the air box up and out of rubber grommets on fender.

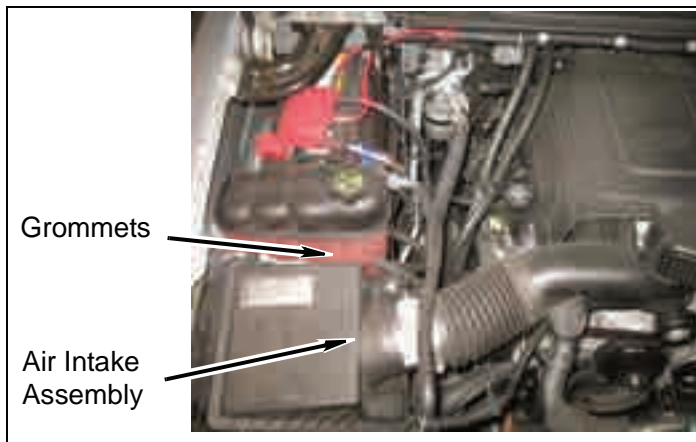

- c. Remove A/C hose from clip on upper fan shroud.

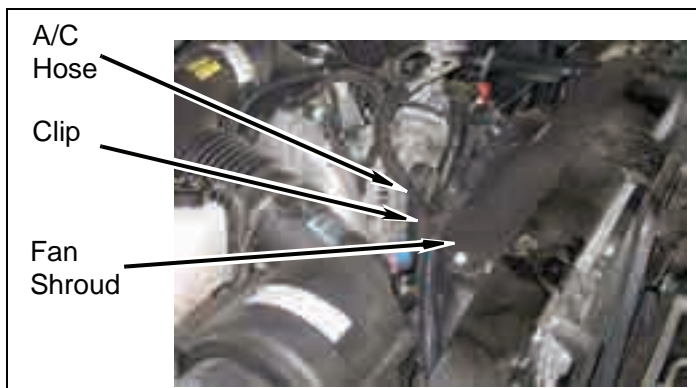

2. Fan shroud

- a. Remove two upper shroud bolts from upper fan shroud.

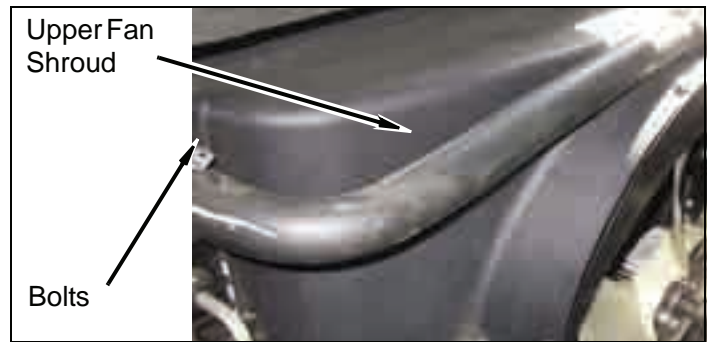

- b. Remove six pop-ups and upper fan shroud from vehicle.

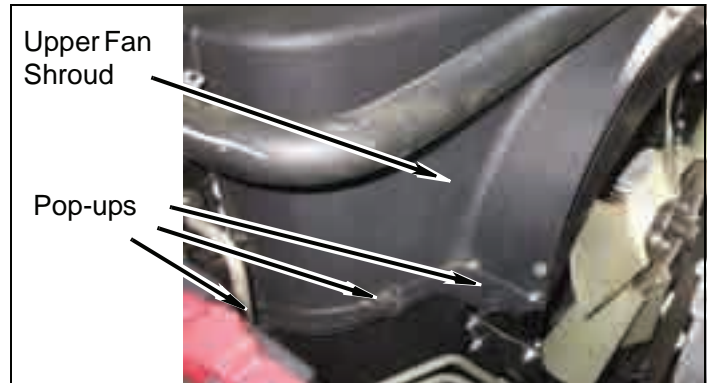

- c. Remove engine fan using a fan clutch tool.

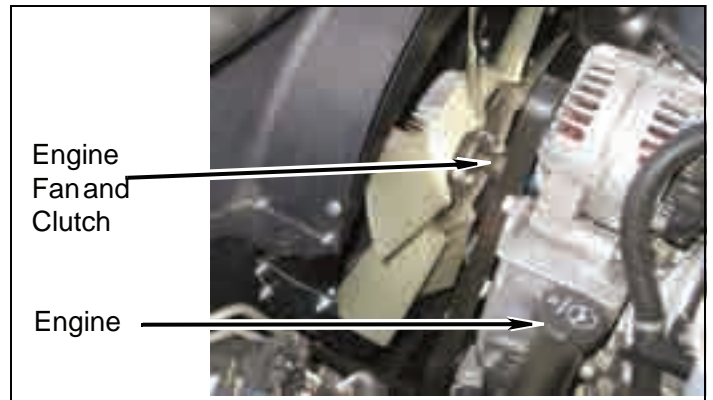

- d. Remove lower fan shroud from clips.



3. Engine harness

- a. Remove clip and harness from engine mounted bracket.

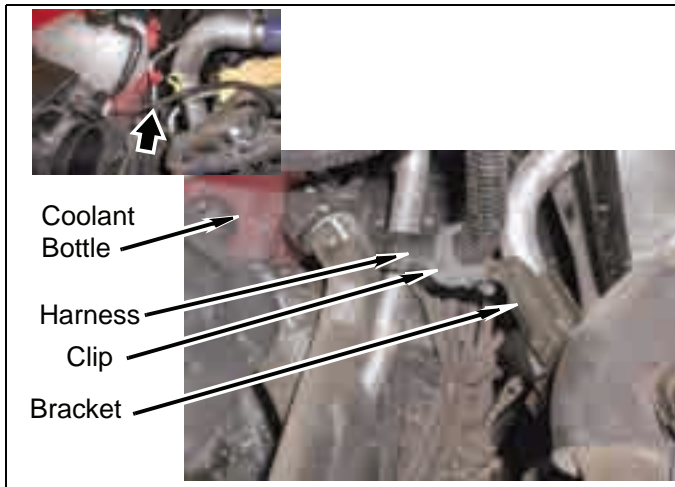

NOTE

Ensure steering shaft does not turn independently of the steering gearbox. This could cause the air bag system to malfunction, resulting in serious personal injury or damage to the equipment.

4. Steering shaft

- a. Straighten steering wheel and strap the wheel so it will not turn.
- b. Remove bolt and nut from upper and lower steering shaft.

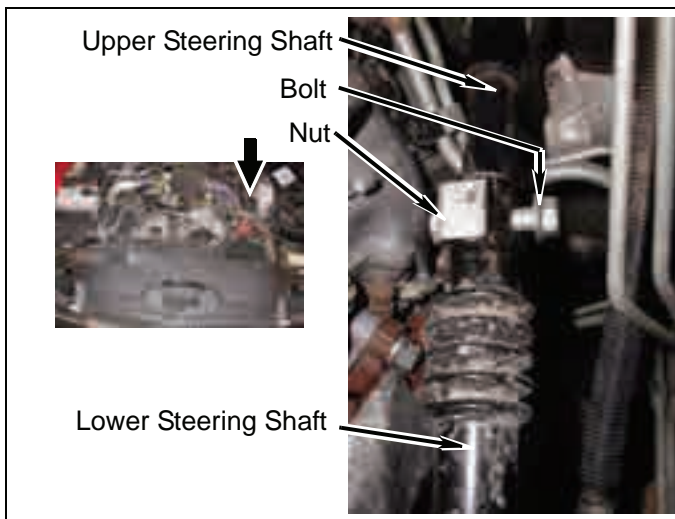

- c. Slide upper steering shaft up to separate from lower steering shaft.

5. Wiring harnesses and ground strap

- a. Remove nut and ground strap from stud on fire wall.

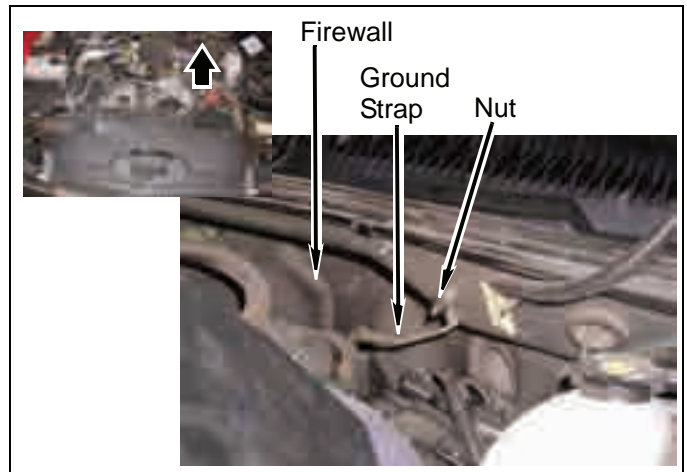

- b. Remove harness from clip and bracket.

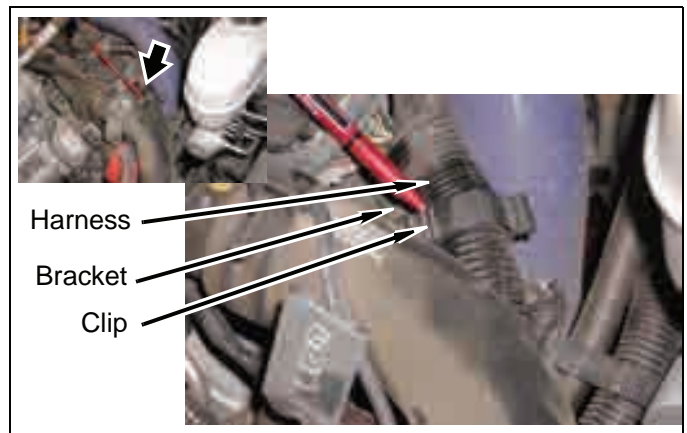

- c. Remove two clips and harness from cover and inner fender.

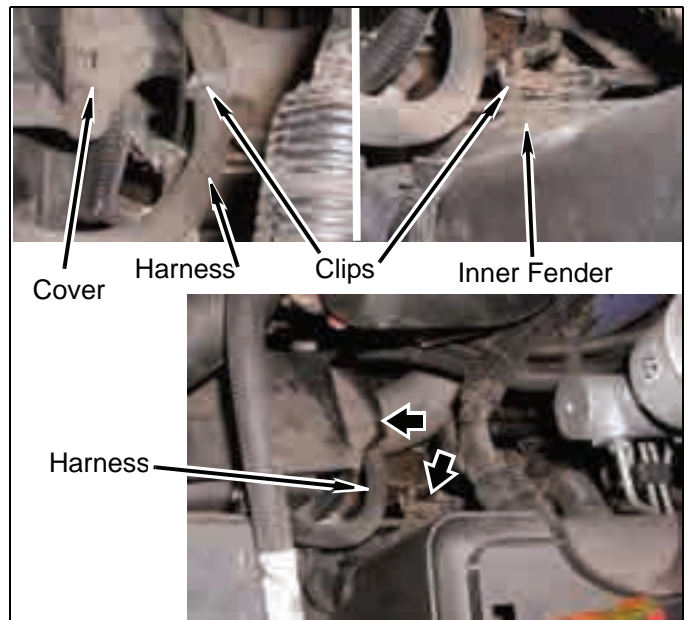

6. Wiring harnesses and power steering drivers side

- a. Remove bolt and two ground wires from frame.

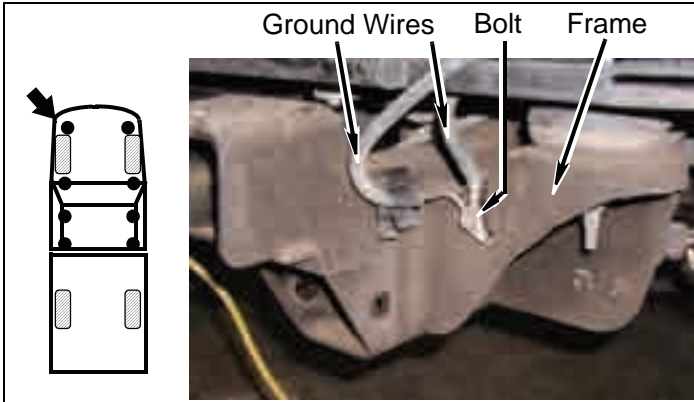

NOTE
Driver side inner fender well was removed for clarity and ease of access.

- b. Remove clip and harness from frame and shock tower driver side.

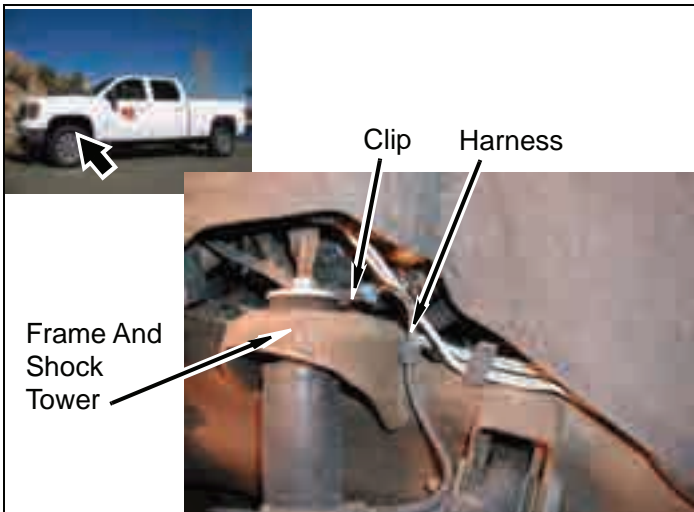

- c. Carefully bend power steering pressure line at power steering pump by pulling toward fire wall as shown. Do not allow line to kink.

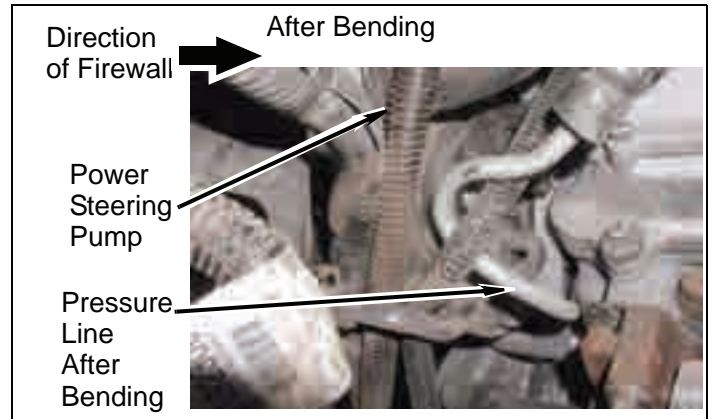
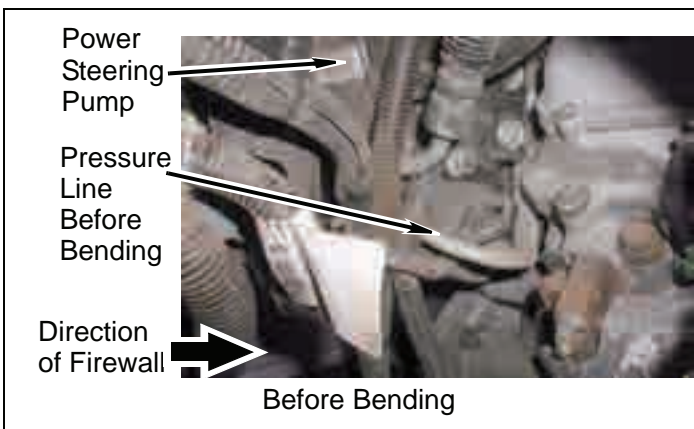

- d. Carefully bend power assist pressure line up toward hood, to clear accumulator on brake hydro boost.

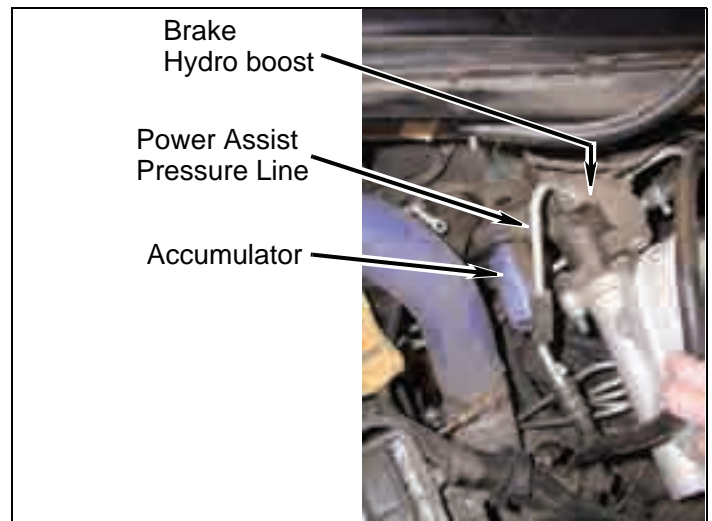

- e. Loosen power assist pressure line fitting at brake droopiest housing and position power assist pressure line along side of accumulator as shown.

- f. Tighten power assist pressure line fitting at brake droopiest housing.

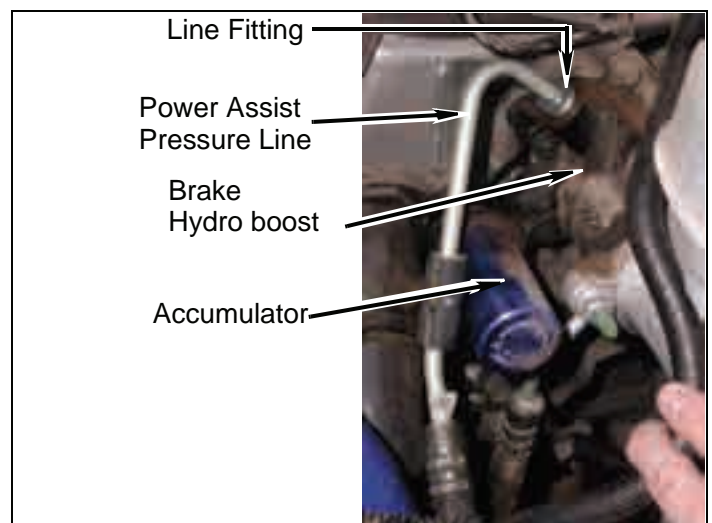

- g. Remove bolt, clamp, and power assist pressure line from frame.

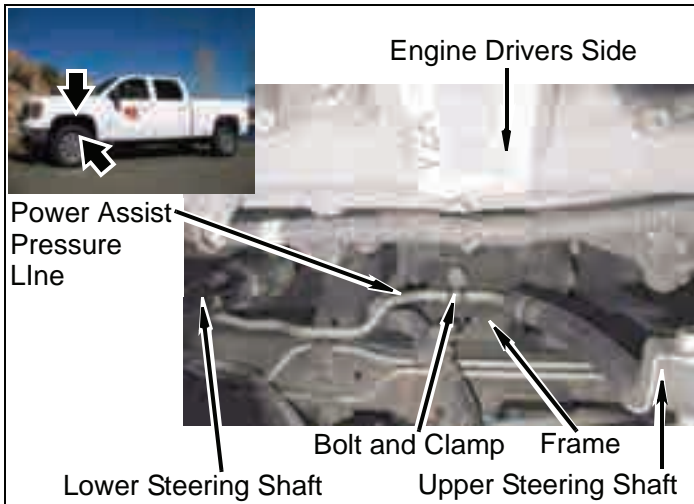

- h. Remove two brake lines from two sets of clips driver side frame.

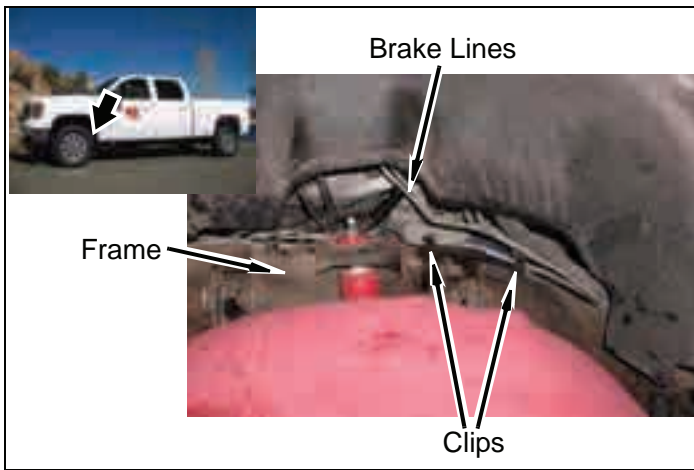

C. Frame

1. Parking brake cable

- a. Remove bolt and ground wires from driver side frame mounting pad.

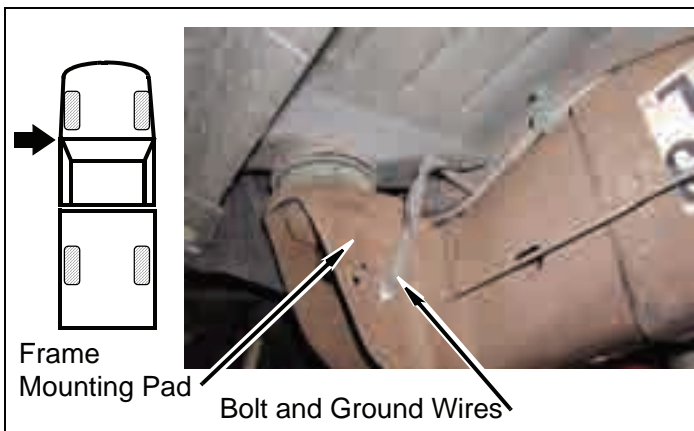

- b. Pull some slack in parking brake cable. Clamp two cables at cable housing where indicated by arrows.

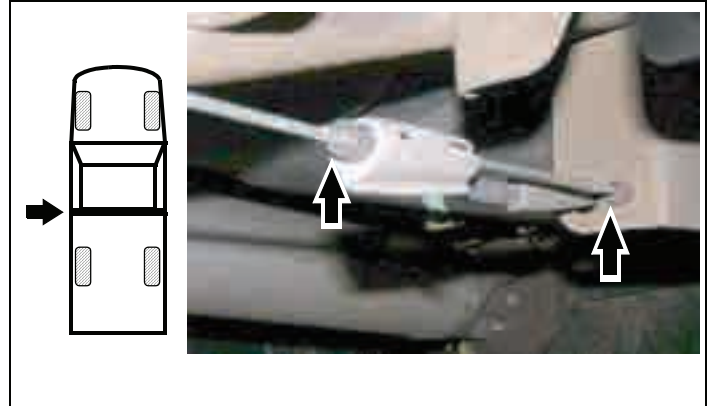

- c. Separate front parking brake cable from rear parking brake cable at cable connector.

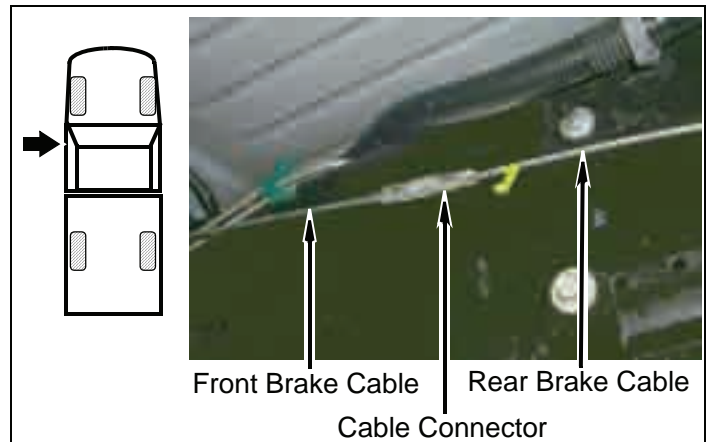

- d. Remove front brake cable and brake cable housing from front frame mounting pad.

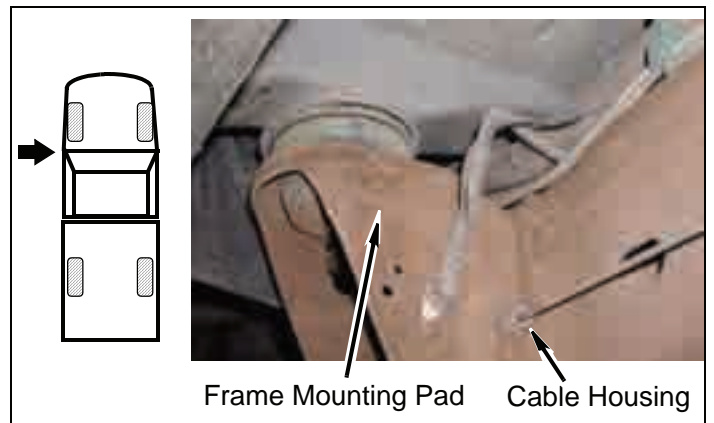

2. Manual transfer case: shift linkage

- a. Remove clip containing three metal lines from bracket.

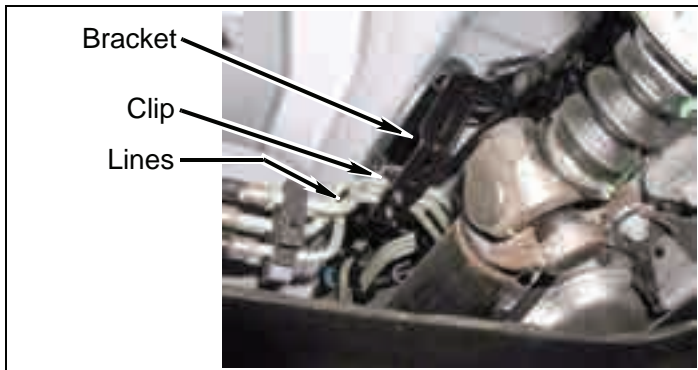

- b. Remove two nuts and bracket from transfer case. Bracket is not reused. Install two nuts and tighten.

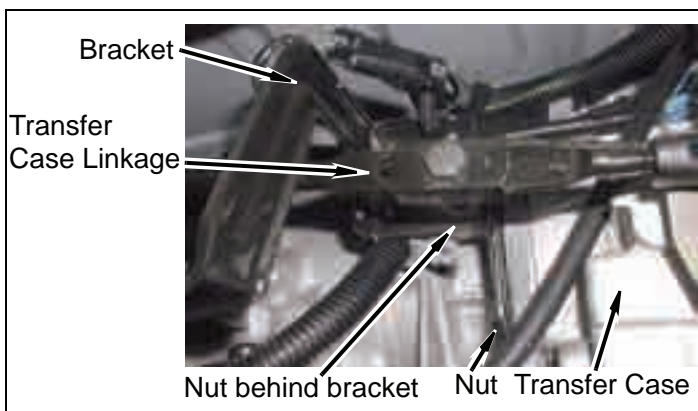

- c. Remove two clips and transfer case linkage from transfer case and pivot.

3. **Single cab only:** Safety cables

- a. If applicable, remove two bolts and safety cables from two rear frame mounting pads.

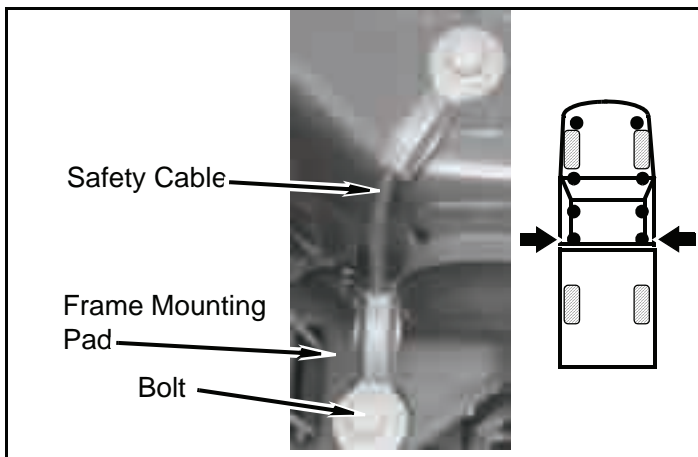

⚠WARNING

Use extreme caution when working near fuel lines and fuel tank. Clean up spilled fuel immediately. Any spark could cause an explosion or fire resulting in serious personal injury and property damage.

D. Rear of vehicle

1. Fuel filler

- a. Remove fuel cap, three bolts, and fuel filler from bed.

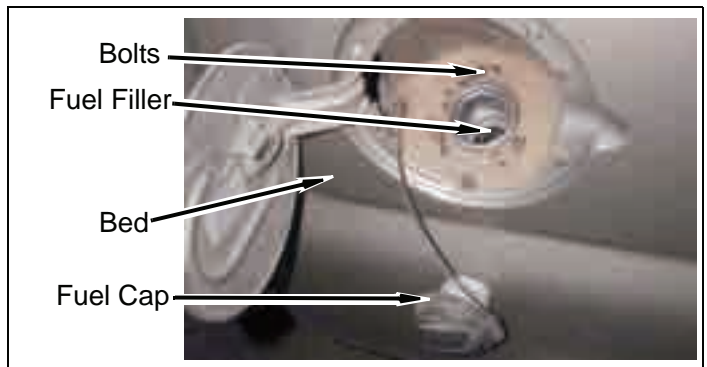

2. Rear bumper

⚠NOTE
Removal of spare tire might be helpful, but not mandatory (refer to the Owner's Manual).

- a. Unplug rear bumper light wiring harness from frame connector.

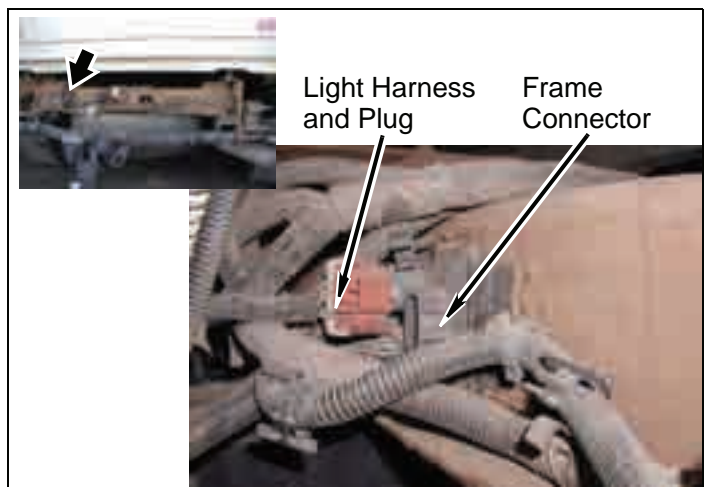

- b. Remove four nuts, two double-bolt fasteners, four bolts and bumper from frame rails.

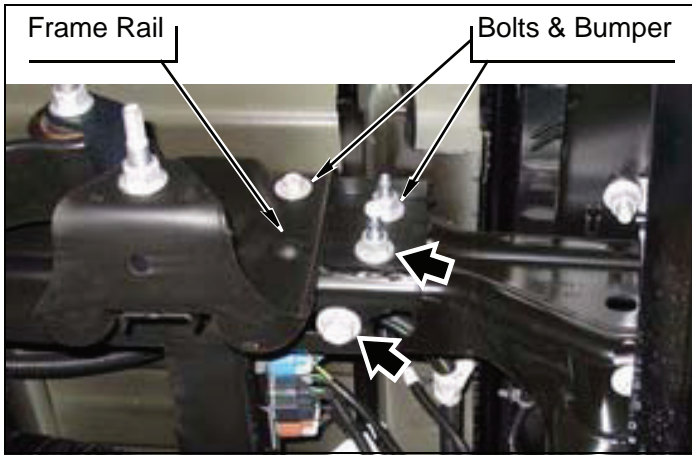

c.

- d. Remove two bolts and bumper from hitch and vehicle.

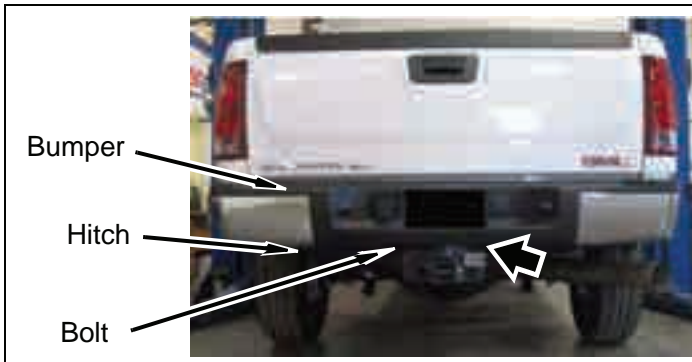

- a. Loosen but do not remove, core support bolt and three cab bolts from drivers side cab.

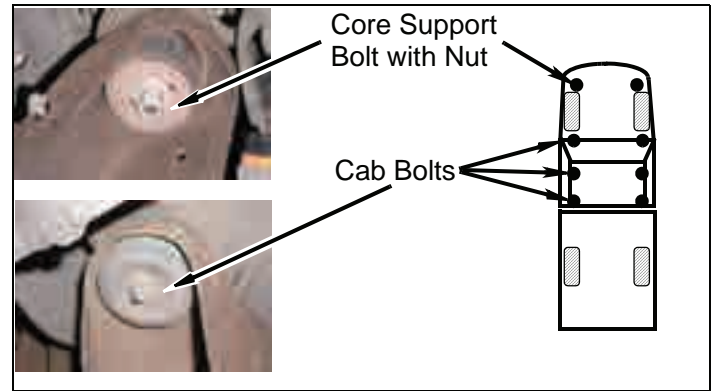

- b. Remove core support bolt, nut, and three cab bolts from passenger side cab.

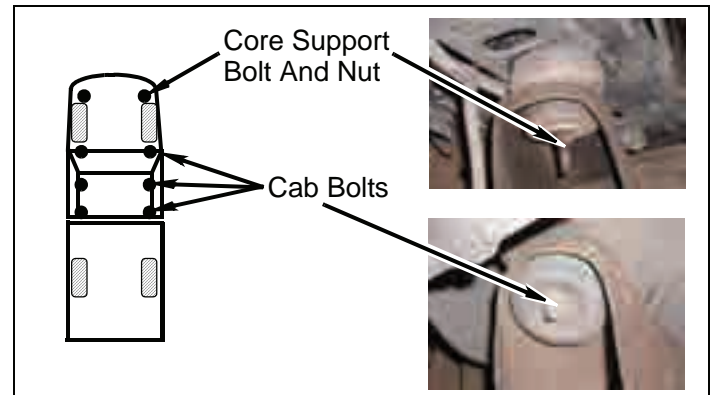

2. Passengers side

Install the kit

A. Cab

- 1. Prepare to lift cab from frame

⚠WARNING

Failure to replace the OEM body mounting hardware (except mounting bolts in the kit) in the stock locations could result in serious personal injury or damage to the vehicle.

⚠NOTE

Ensure stock spacers and body bushings stay on vehicle unless otherwise specified in these instructions. Kit lift **blocks** are installed in addition to the stock spacers and body bushings.

⚠CAUTION

Continually check hoses, wires, lines, etc. to be sure that everything is flexing properly and not binding, or damage to the vehicle could result. Be especially careful of the a/c hoses at the fire wall, the belt pulley, and at the core support. Ensure brake lines extend while lifting. Bending the lines to gain ample slack may be necessary. Be extremely careful not to kink the lines.

⚠WARNING

Use extreme caution when lifting body from frame. Ensure lifting device is securely placed. Keep hands out from between frame and body, or serious personal injury could result.

- a. Using a hydraulic jack and a wooden block, slowly lift cab high enough to position a kit lift **block** between core support and body bushing. Position three kit lift **blocks** between cab and remaining body bushings.

- b. Install a kit **lift block** under core support and on top of upper body bushing, frame, and lower body bushing with a kit **bolt** (12mm-1.75 x 180mm), kit **washer** (1/2" thick), and stock nut. Do not tighten.

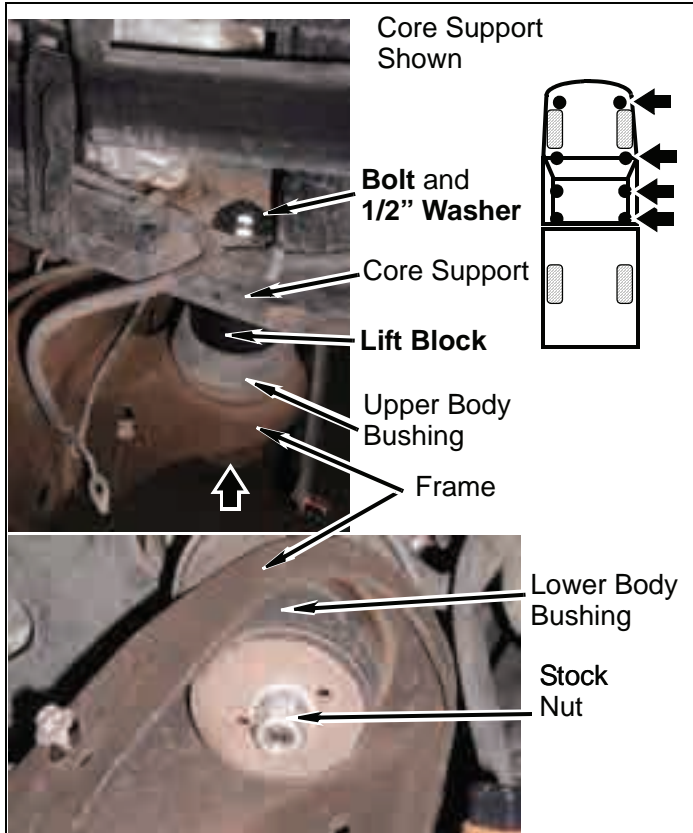

- c. Install three kit lift **blocks** (with 5/8" hole) under body and on top of top body bushings, frame, and lower bushings, with three kit **bolts** (14mm-2.0 x 180mm) and kit **washers** (14 mm). Do not tighten.

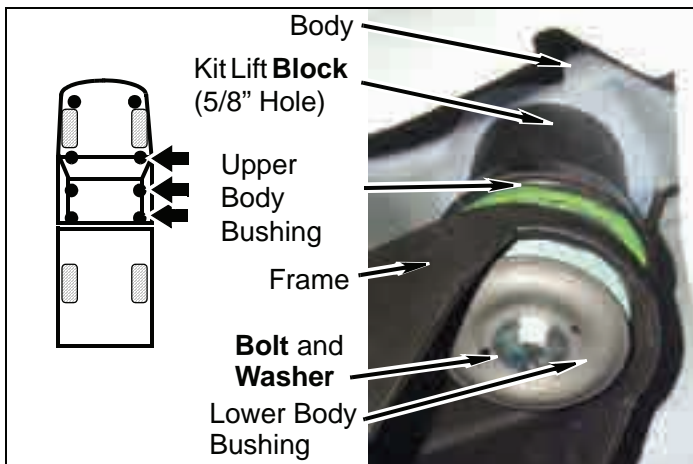

- d. Lower cab onto kit lift **blocks**.

3. Drivers side

- a. Repeat above steps for the cab driver side.
- b. Adjust cab to bed clearance as needed using measurements taken earlier.

4. Finish cab lift **block** installation

- a. Remove eight **bolts** one at a time, place a few drops of kit **Loctite**® on threads, install and tighten to 55ft.lbs.

B. Bed

1. Prepare to lift bed from frame.

- a. Loosen but do not remove four bed bolts driver side (short bed three bolts).

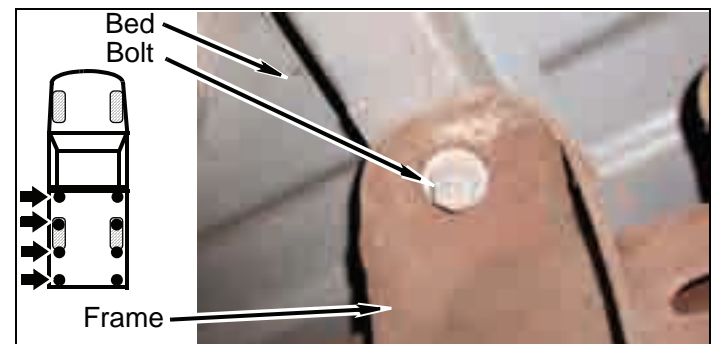

- b. Remove four bed bolts from frame passenger side.

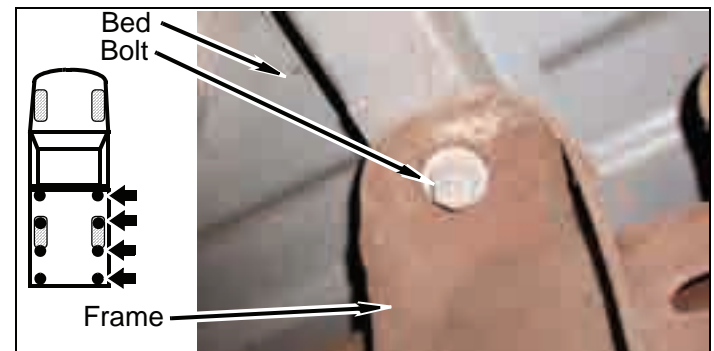

2. Bed passenger side

- a. Using a hydraulic jack and a wooden block, slowly lift the bed high enough to position the kit lift **blocks** between bed and frame mounting pads.

- b. Position four kit lift **blocks** (3" Diameter) between bed and frame as shown.

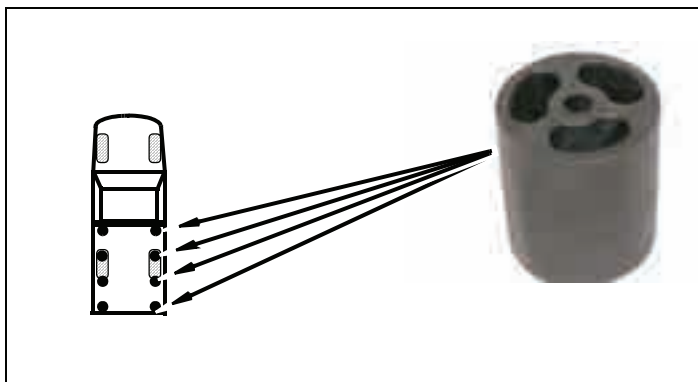

- c. Install kit lift **blocks** on frame and bed with four kit **bolts** (12mm-1.75 x 100mm) and four kit **washers** (7/16" USS). Do not tighten.

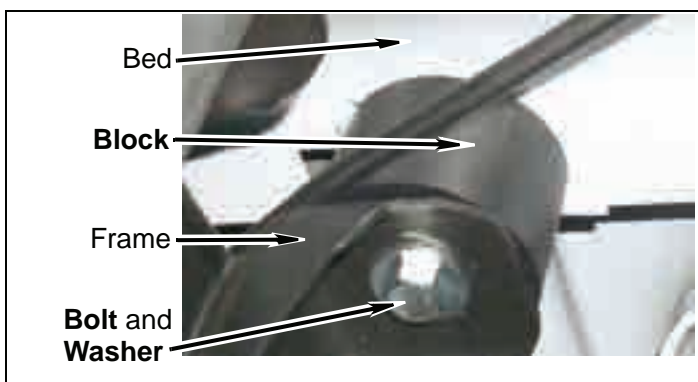

- d. Lower bed onto kit lift **blocks**.

3. Install driver side bed kit lift **blocks**.

- a. Repeat above steps for driver side.

4. Finish the bed kit lift **block** installation.

C. Rear of vehicle

⚠WARNING
 The following procedure is intended only to enhance the appearance of the vehicle. The rear bumper will no longer be rated for towing of any kind. Towing with the rear bumper after it has been lifted can result in death, serious personal injury, or damage to the vehicle. Towing after the bumper has been lifted should be accomplished using a rated Class III receiver type hitch.

1. Install rear bumper

- a. Mark, cut, and bend crossmember for spare tire crank tube as shown.

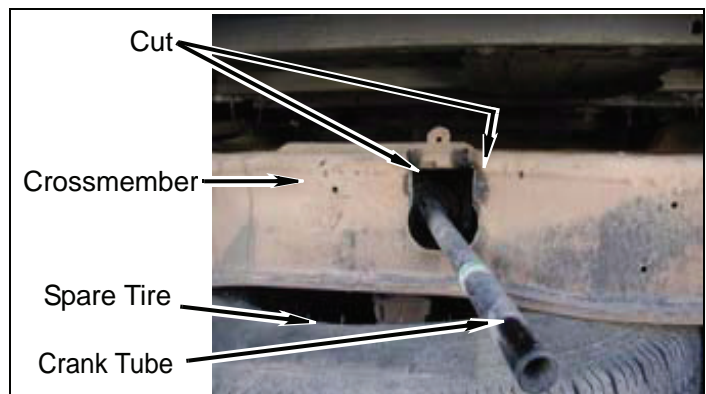

2. Rear bumper

- a. Remove two clips from fascia and bumper.

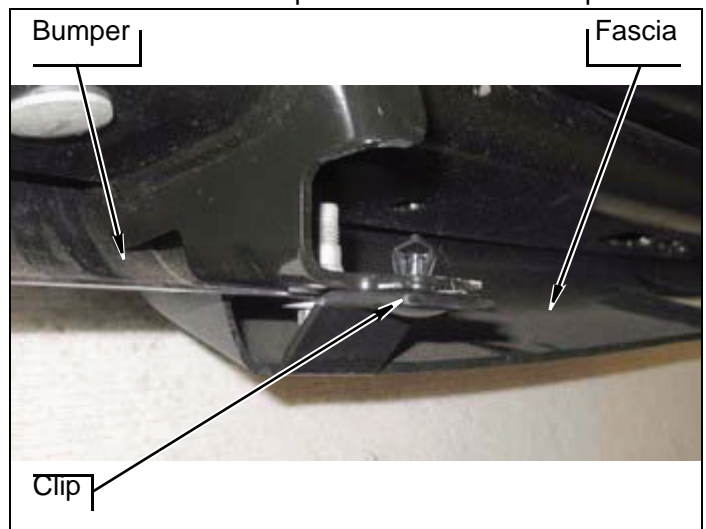

⚠NOTE
 Place a few drops of Loctite® on threads of all bolts.

- a. Adjust bed to cab clearance as needed using measurements taken earlier.
- b. Remove eight kit **bolts** one at a time, place a few drops of kit Loctite® on threads, install and Tighten to 55ft.lbs.

b. Remove two bolts from bottom of bumper.

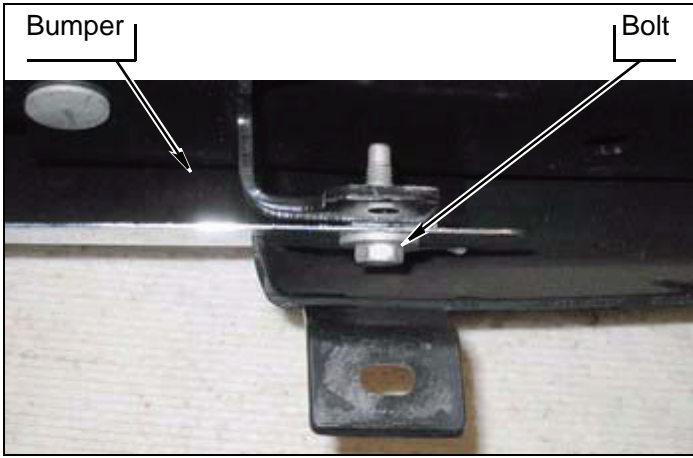

c. Remove six nuts, two carriage bolts and bumper support from bumper.

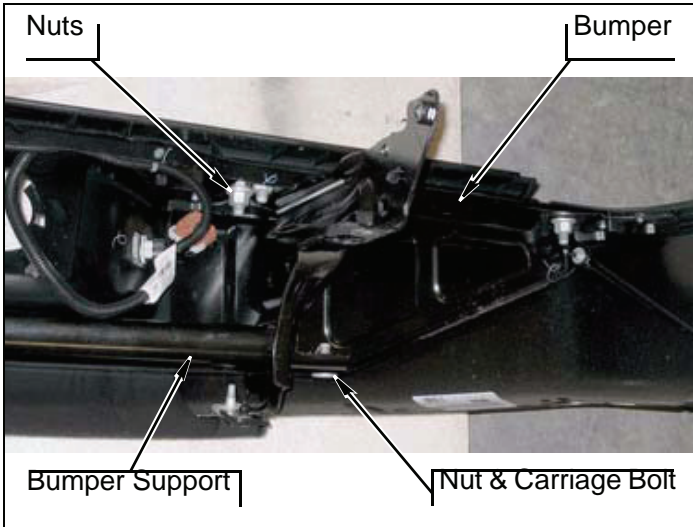

d. Cut two brackets and remove from bumper support as shown.

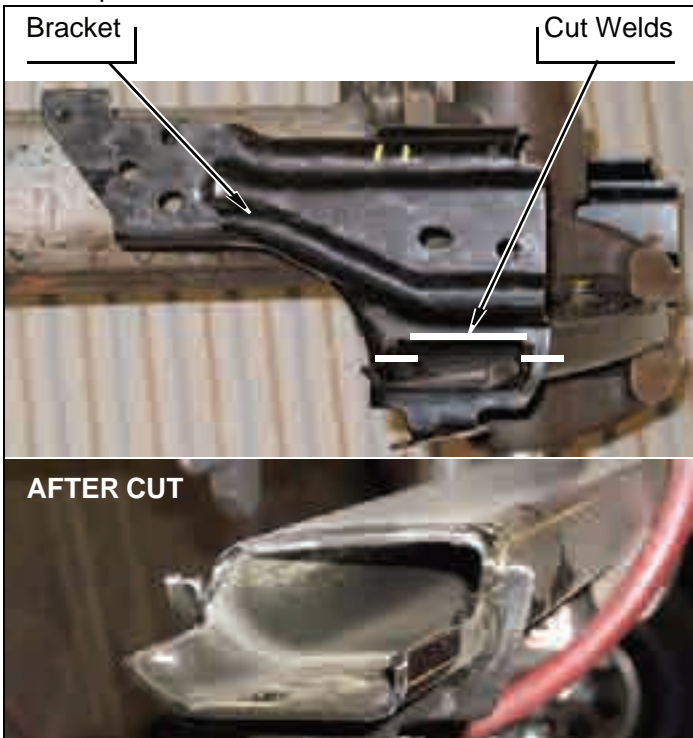

e. Position two *kit brackets* (bumper, rear) onto bumper support against stop.



NOTE

Please note that Frame is boxed in and there is no access to inside of frame rails.

f. Install bumper support and two *kit brackets* (bumper, rear) onto bumper with two O.E. carriage bolts and six nuts. Snug, but DO NOT TIGHTEN

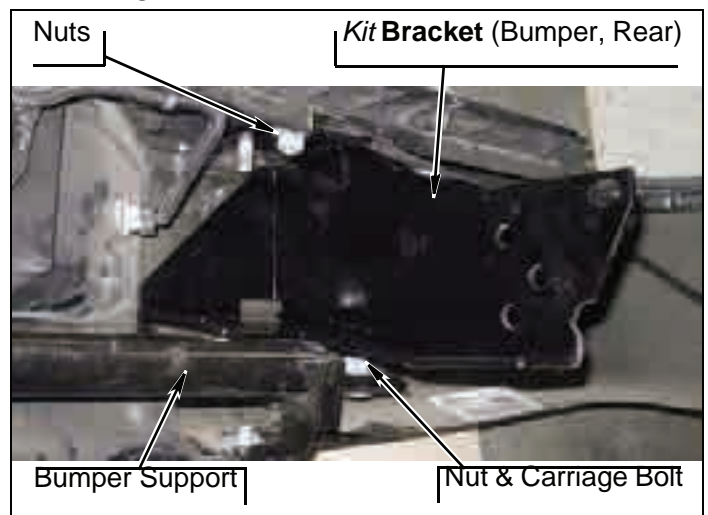

- g. Install bumper onto frame rails with all O.E. double-bolt fasteners. Snug, but DO NOT TIGHTEN.

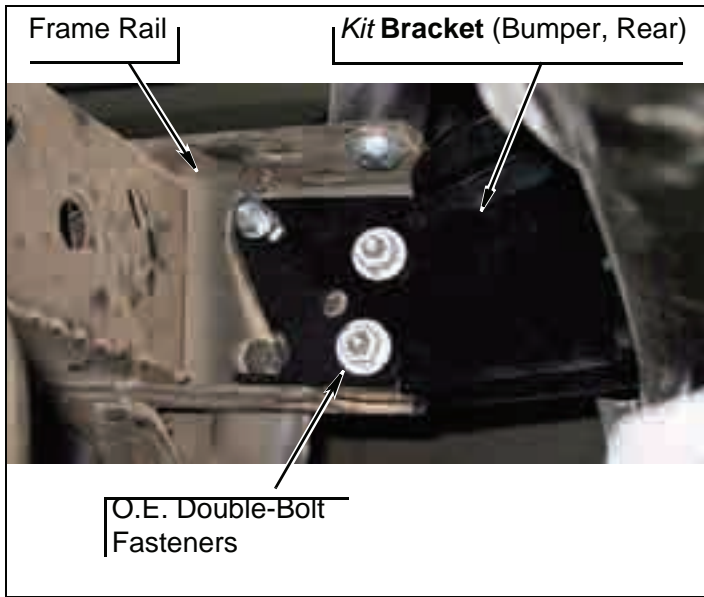

- h. Mark eight holes through two *kit brackets* (bumper, rear) onto bumper support.

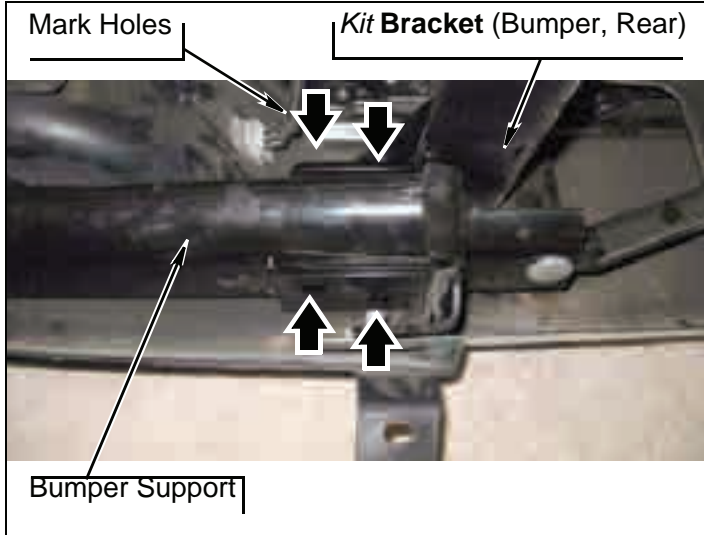

- i. Remove two O.E. double-bolt fasteners, two nuts and bumper from frame rails.
- j. Remove six nuts, two carriage bolts and bumper support from bumper.

- k. Drill eight 1/2" holes through bumper support at marked locations.

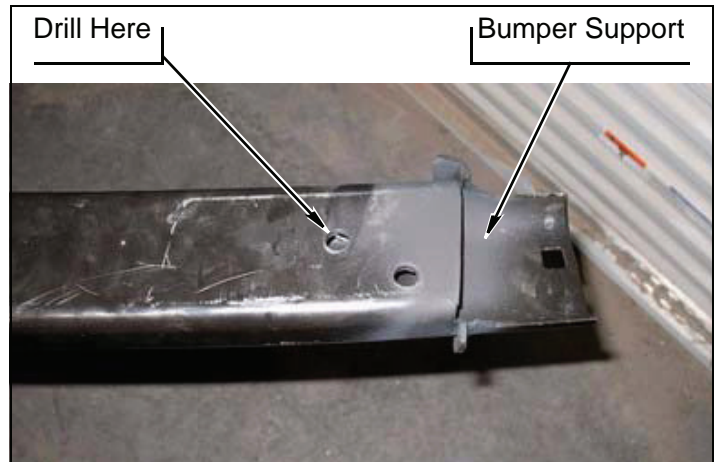

- l. Install bumper support onto two *kit brackets* (bumper, rear) with four *kit bolts* (1/2"-13 x 3"), eight *kit washers* (1/2" SAE) and four *kit nuts* (1/2"-13 Stover). DO NOT TIGHTEN.

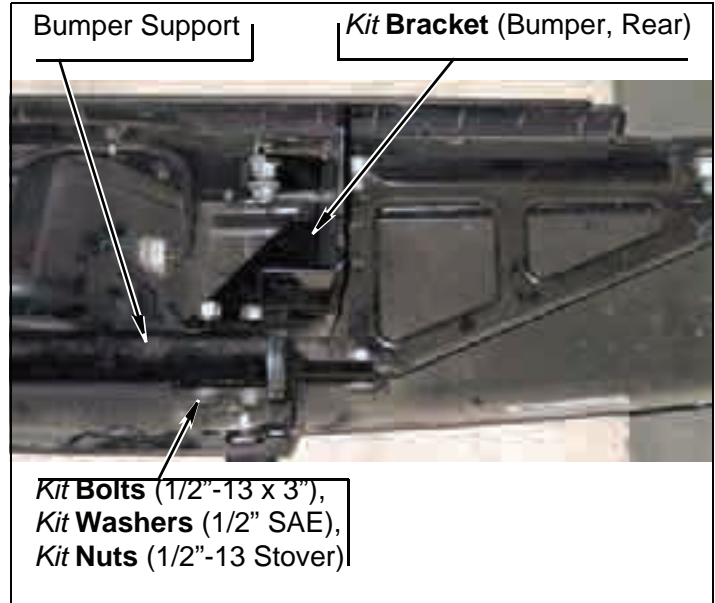

- m. Install bumper support and two *kit brackets* (bumper, rear) onto bumper with two O.E. carriage bolts and six nuts. DO NOT TIGHTEN.

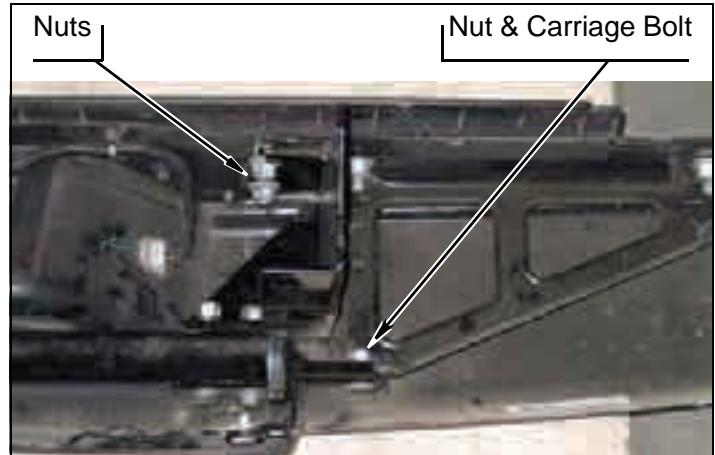

- n. Install bottom of bumper onto bumper support with two bolts.

- o. Install fascia onto bumper with two clips.
- p. Install bumper onto frame rails with all O.E. double-bolt fasteners and nuts. DO NOT TIGHTEN...

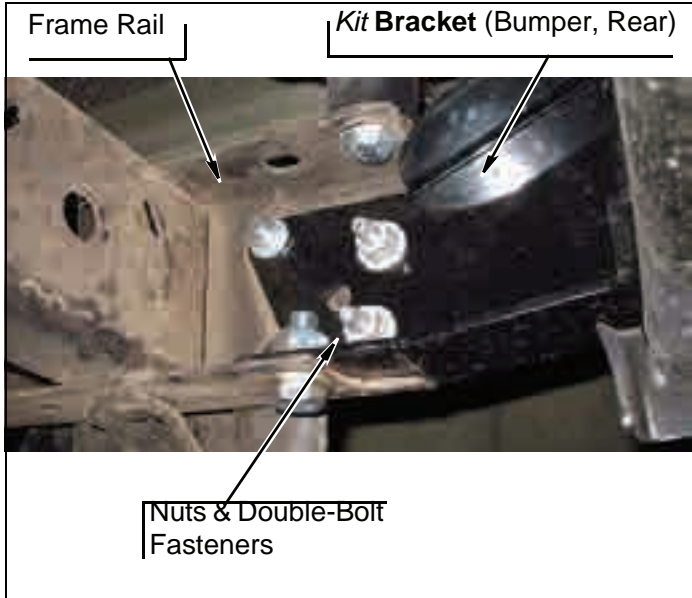

- q. Install kit **bracket**, hitch spacer, on rear bumper and hitch with two kit **bolts** (14mm x 110mm) and two kit **washers** (14mm). Do not tighten.

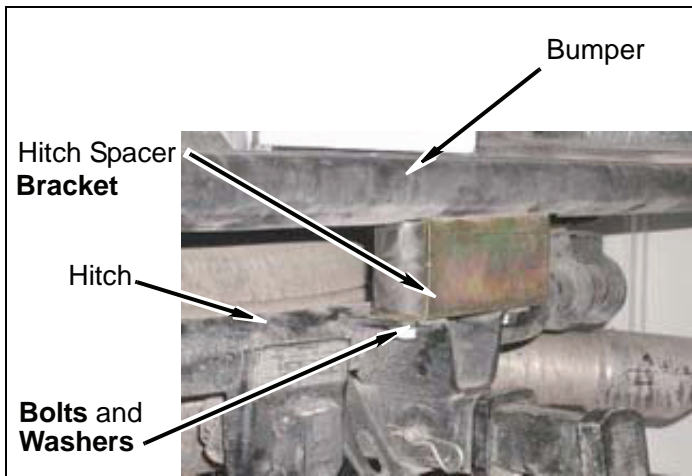

- r. Adjust bumper to bed clearance using measurements taken earlier and tighten hitch bolts first then remaining bolts and nuts to 55 lb-ft.

- s. Plug license plate light harness in at crossmember connector.

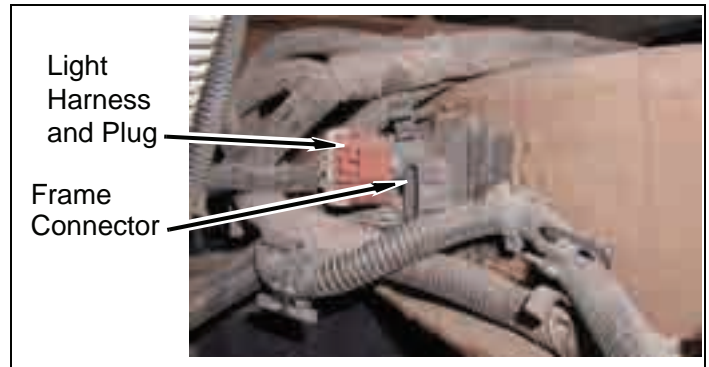

3. Fuel filler

⚠WARNING

Use extreme caution when working near fuel lines and fuel tank. Clean up spilled fuel immediately. Any spark could cause an explosion or fire resulting in serious personal injury and property damage.

- a. Install fuel filler on the bed with three bolts. Install fuel cap.

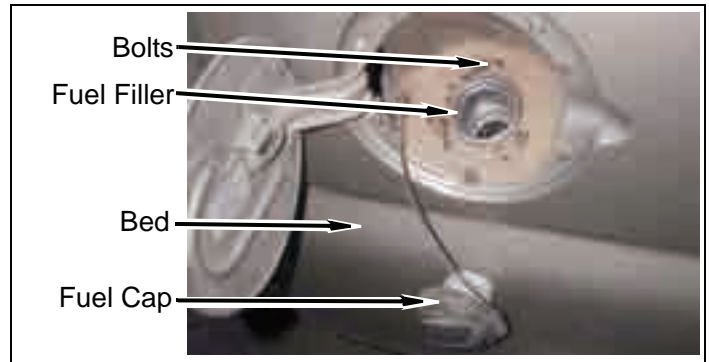

D. Frame

- 1. Safety cables, single cab only
 - a. Install two kit **brackets**, safety cable extension on frame rear mounting pads with two bolts.

- b. Install two safety cables on kit **brackets**, safety cable extension with two kit **bolts** (3/8" x 1 1/2"), four kit **washers** (3/8" USS), and two **nuts** (3/8" nylock).

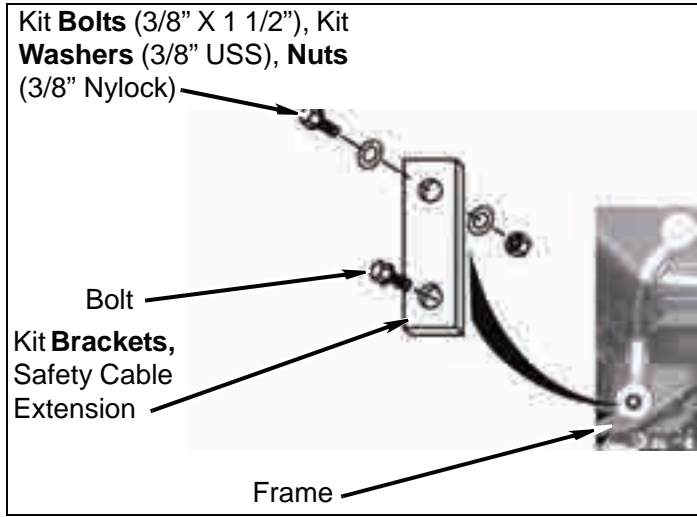

2. Parking brake cable.

NOTE
Some filing of drilled 7/16" hole may be required to allow parking brake cable housing to fit properly.

- a. Using kit parking brake bracket as templet, mark & drill a 7/16" hole in the frame over original hole as shown.

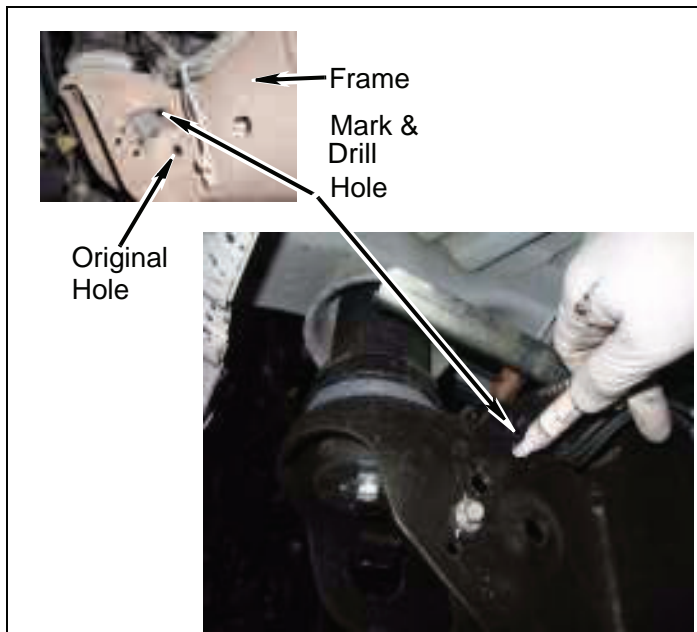

- b. Relocate parking brake cable into **kit park bracket** and mount using **kit 7/16"** hardware. .

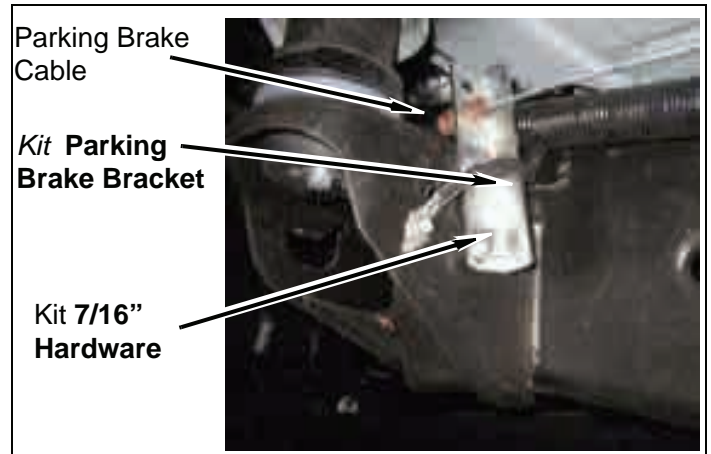

- c. Install two ground wires on frame mounting pad with bolt. Connect front and rear brake cables. Remove clamps from rear cable. **Note:** **Kit washer** may be used between **kit bracket** and body mount to keep bracket aligned.

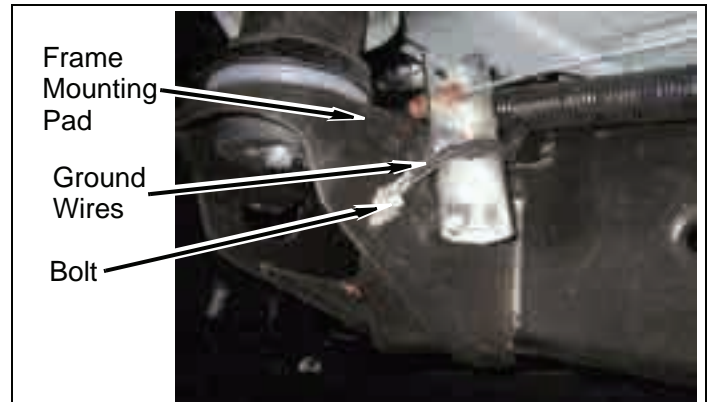

NOTE
The following step is for vehicles with manual transfer case only. Other models skip this step.

3. Lengthen and install transfer case shift lever.

- a. Remove two spring clips and transfer case linkage from shift lever, transfer case shift arm.

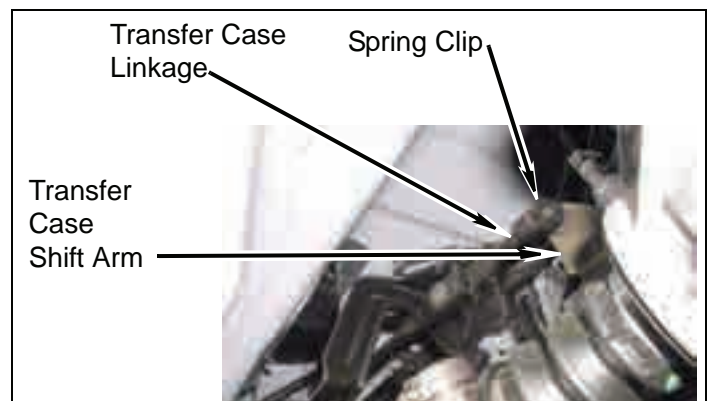

- b. Scribe a line along transfer case linkage as shown. Cut transfer case linkage into two pieces through the scribed line and deburr.

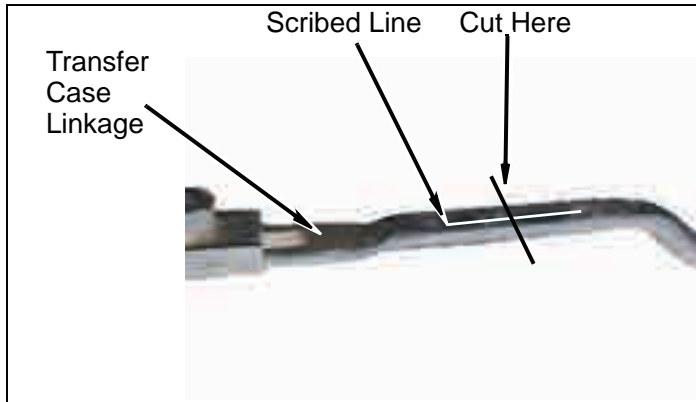

⚠WARNING
A certified welder should perform all welding.

- c. Position kit **pin** 4x4 extension between two pieces of transfer case linkage. Ensure transfer case linkage scribed lines align and weld kit **pin** extension in place.

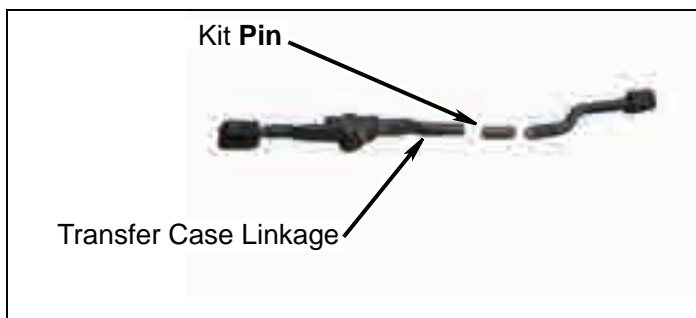

- d. Install transfer case linkage on transfer case shift arm and shift lever with two clips.
- e. Check transfer case shift lever operation. Ensure there is complete engagement in all ranges. If necessary, adjust the linkage.

4. **Manual transmission** shift lever.

⚠NOTE
Manual transmissions require shift extension SE4701 **purchased separately**. Automatic transmission models skip this step.

5. Driver side wheel well and frame rail.

- a. If possible, install four harness clips on frame and wheel well.

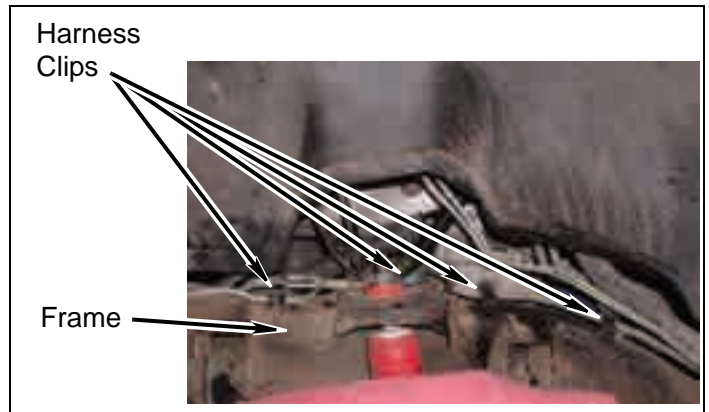

- b. If possible, install two brake lines in two sets of clips. If brake lines will not fit back into position, wrap lines with two kit **zip ties** individually, and then secure the lines together with one kit **zip tie** as a bundle.

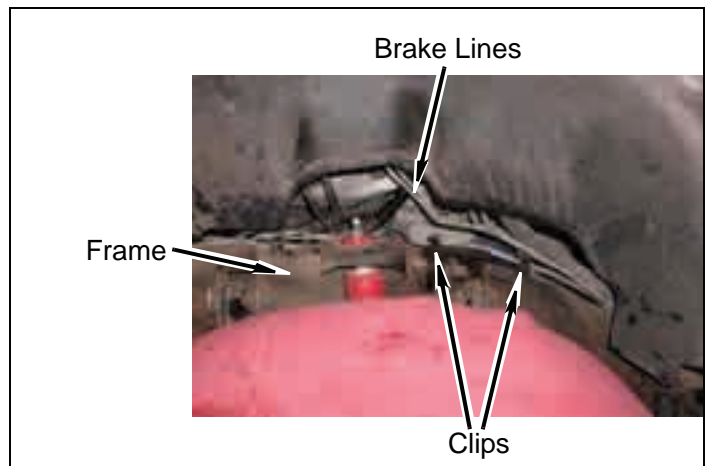

- c. If possible, install harness in clip on frame driver side.

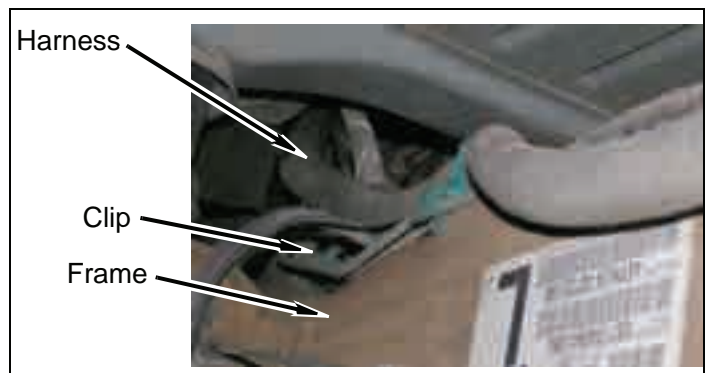

E. Engine Compartment

- 1. Wiring harnesses and ground strap

a. If possible, install clip in bracket (*top of engine*).

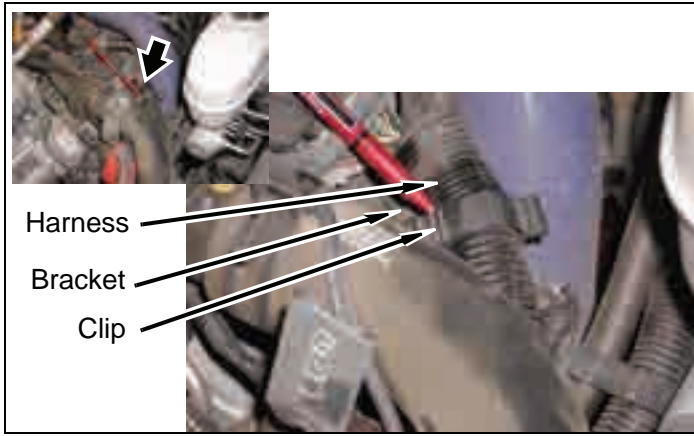

b. Install ground strap on stud with nut.

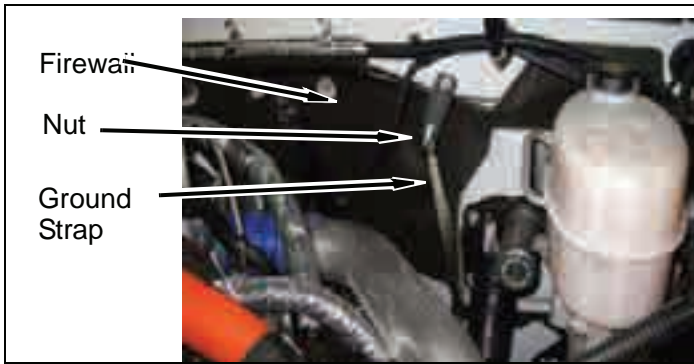

2. Install kit steering extension.

- a. Place a few drops of kit Loctite® on threads of bolts for both following steps.
- b. Install kit **steering extension** on upper steering shaft with kit **bolt** (3/8" x 1 3/4"), two kit **washers** (3/8" SAE), and kit **nut** (3/8" nylock). Do not tighten.
- c. Install kit **steering extension** into lower steering shaft with bolt and nut. Tighten bolt to 33 lb-ft.

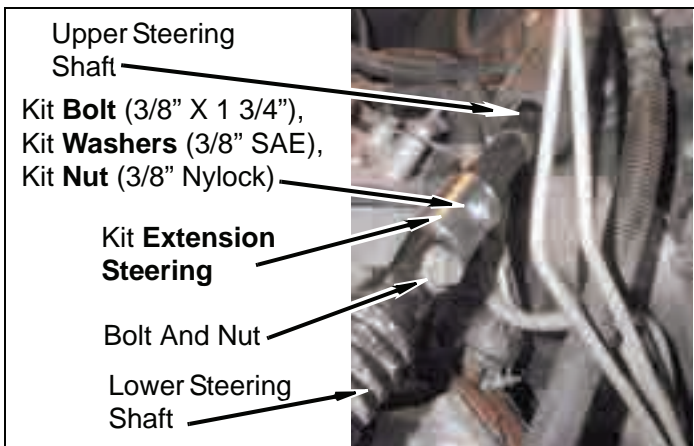

3. Lower Fan shroud.

a. Locate and mark lower fan shroud along the molded seam for trim cut.

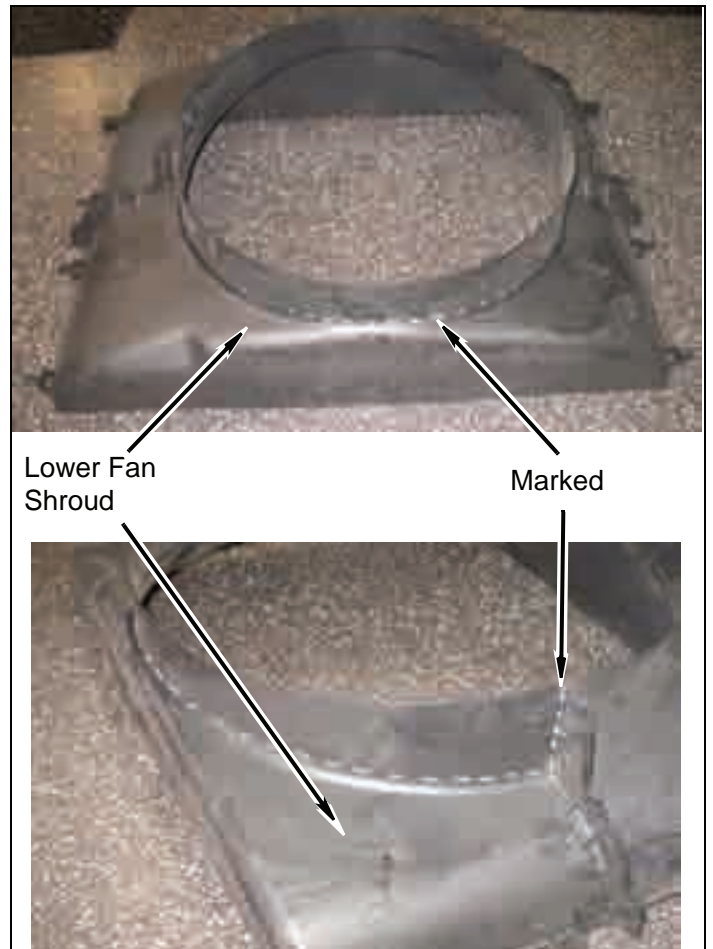

b. Trim cut along marked line and remove lower section of lower fan shroud.

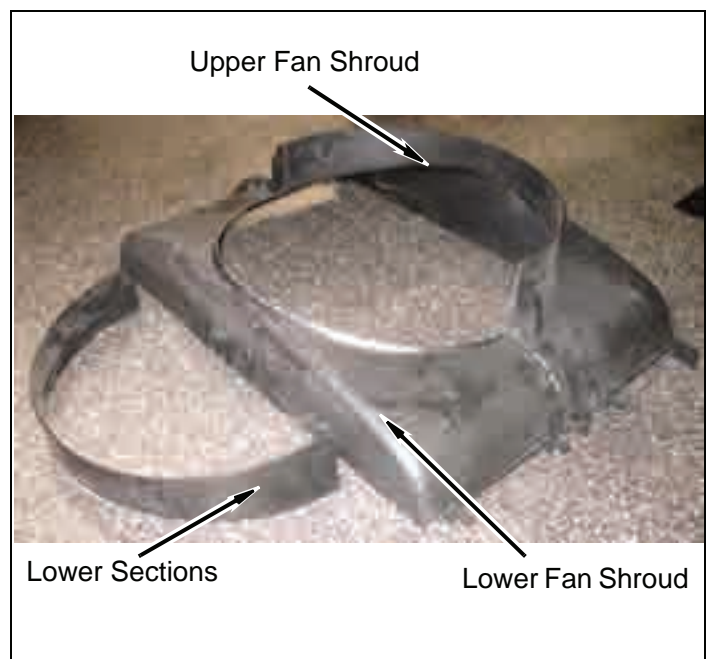

4. Upper fan shroud.

- a. Assemble fan shroud using six OEM push clips.
- b. Locate factory lower fan shroud section and two **kit side shroud drop plates**.



- c. Using a pair of visegrips or clamps; create a 3" gap at the center of the fan shroud by separating & squaring the main engine fan shroud with the lower fan shroud insert shield; then clamp the assembly together using two **kit side shroud drop plates** at each side.

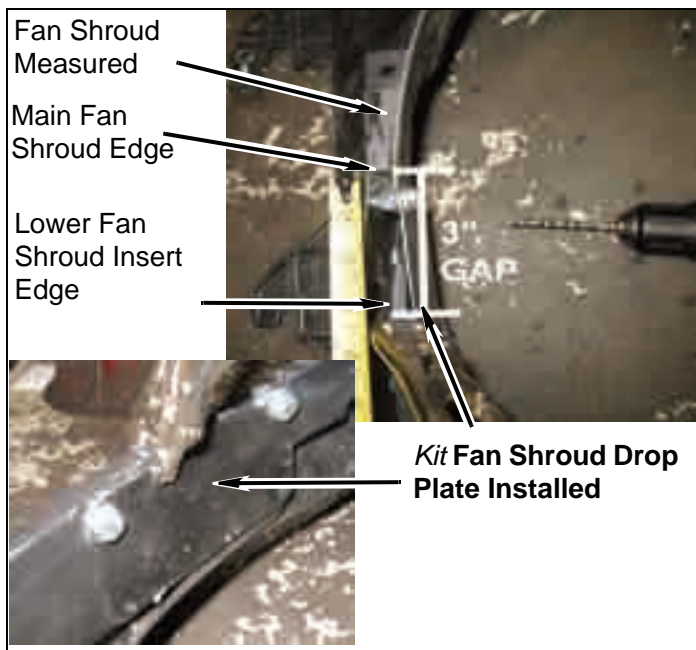

- d. Once you have shaped and placed each **kit fan shroud drop plates** into place; reclamp and secure each **kit shroud plate** at a 3" gap and mark each 1/4" holes for drilling.

Note: Leaving each **kit drop plate** in place, while drilling, will ensure that you drill through the proper locations while drilling all four holes during this process.

- e. Once you have drill each hole use four **kit (1/4"x 3/4")**, **nuts & washers** to fasten each **kit fan shroud drop plates** into place. *Do not tighten at this time.*
- f. Assemble both pairs of **kit fan shroud block of plates** using two **kit bolts(1/4"x3/4")**, **washers & nuts** in center of kit plates as shown below. (Leave brackets slightly loose until mounted onto fan shroud, this will allow you to adjust the plates as needed to fit shroud properly.)
- g. With both **kit fan shroud block off plates** assembled, face the tabs inwards so that the **kit fan shroud block off plate** assembly mounts evenly with the edge of the upper fan shroud.

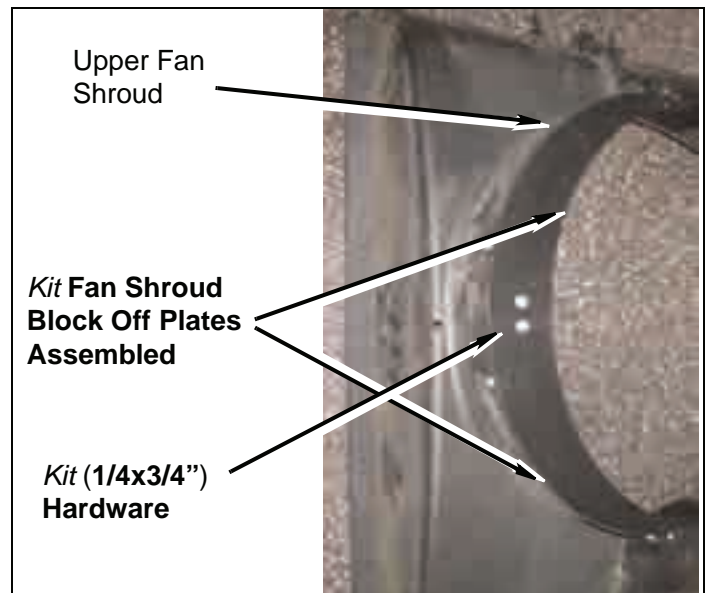

- h. Once you have matched the **kit fan shroud block off plate** assembly to the upper fan shroud, **Mark & Drill** all four 1/4" holes.
- i. Use four **kit bolts(1/4"x3/4")** **washers & nuts** to secure **kit fan shroud block off plate** assembly to upper fan shroud. Tighten **kit hardware** at this time.

Note: Be sure to install all **kit (1/4")** hardware from inside to outside of kit fan shroud brackets. Doing so will eliminate the chance of kit hardware contacting the engine fan blades after shroud is reinstalled into vehicle

Note: Do not attempt to over tighten kit hardware against fan shroud, damage will occur to shroud.

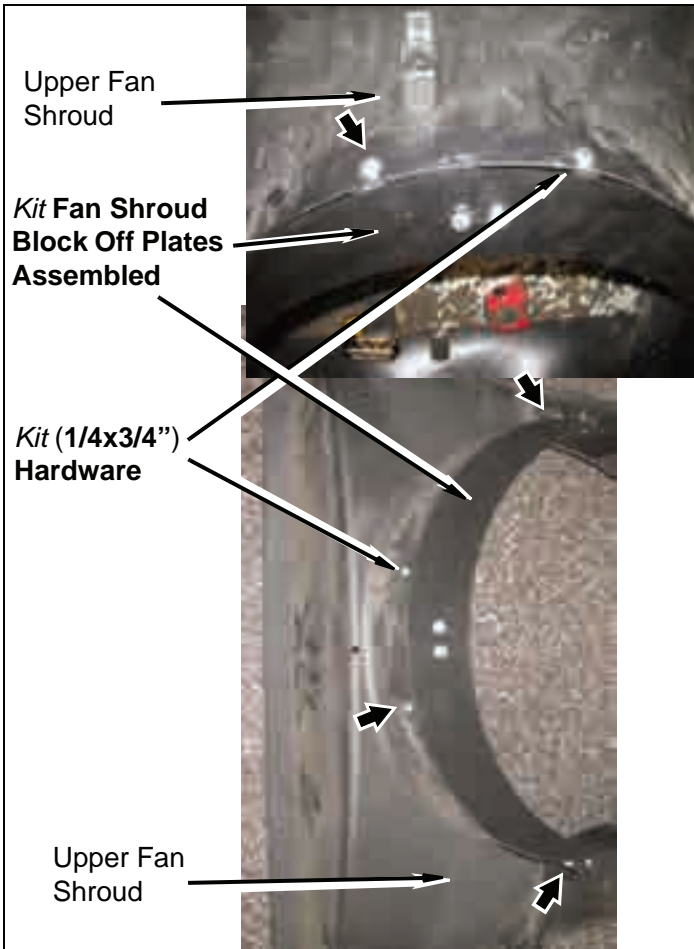

j. Using second pair of **kit fan shroud block off plates**. (Leave brackets slightly loose until mounted onto fan shroud, this will allow you to adjust the plates as needed to fit shroud properly.) With both **kit fan shroud block off plates** assembled, face the tabs outwards so that the **kit fan shroud block off plate** assembly mounts evenly with the inside edge of the lower fan shroud assembly. (*Tighten assembly now.*)

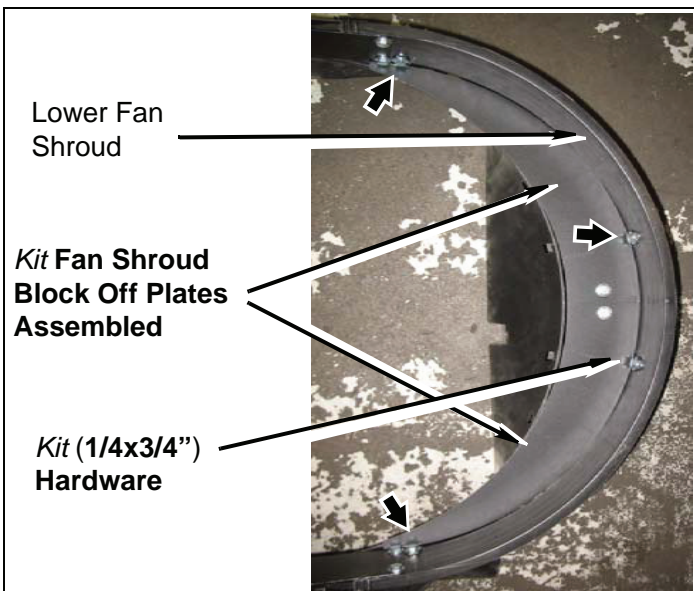

k. Install **kit lower fan shroud block off plate anchor** onto **kit lower fan shroud block off plate** assembly by using existing **kit (1/4")** hardware and drilling a 1/4" hole into center of the shroud and installing **kit (1/4")** hardware to anchor center of lower shroud assembly.

Note: Do not attempt to over tighten kit hardware against fan shroud, damage will occur to shroud.

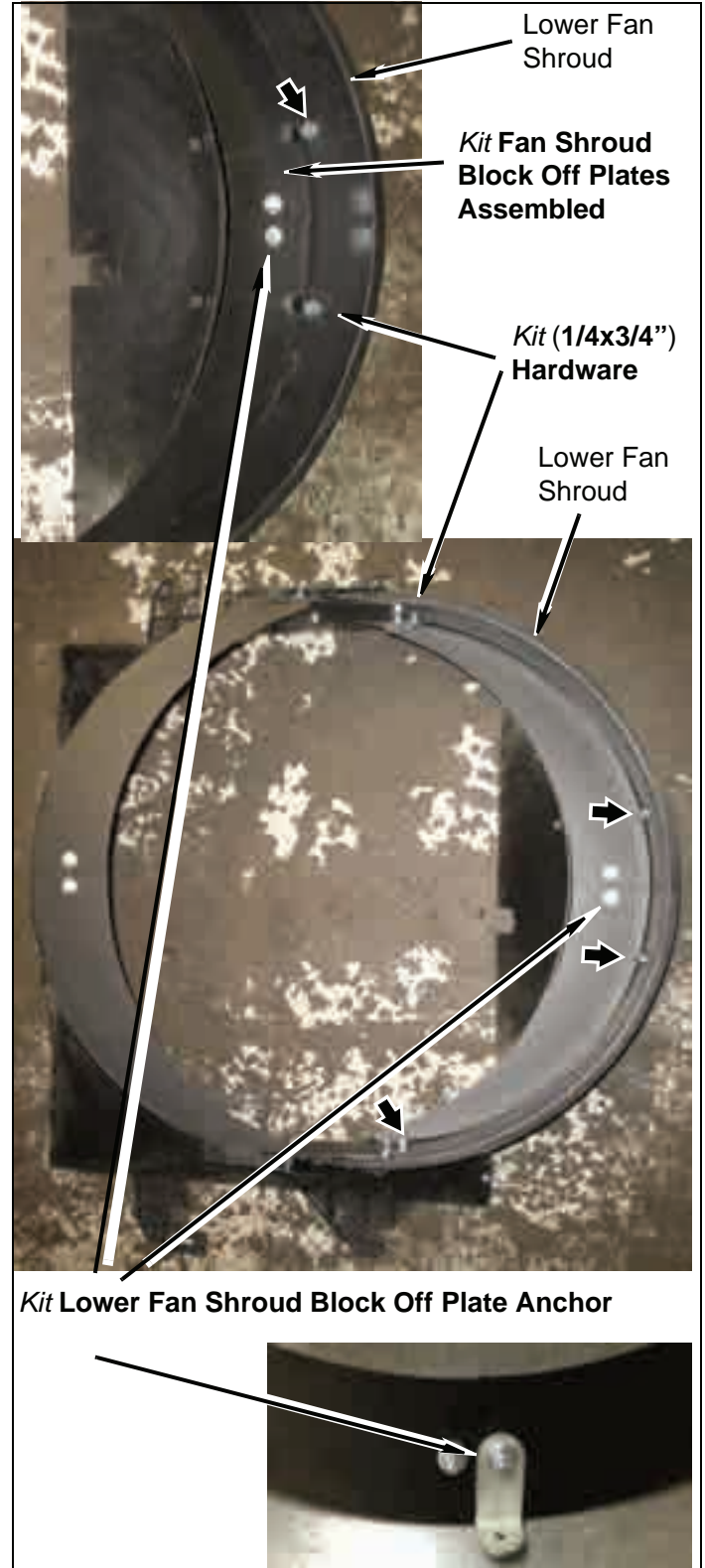

- I. Install engine fan and shroud assembly as one unit; use a fan clutch tool to tighten fan clutch. .

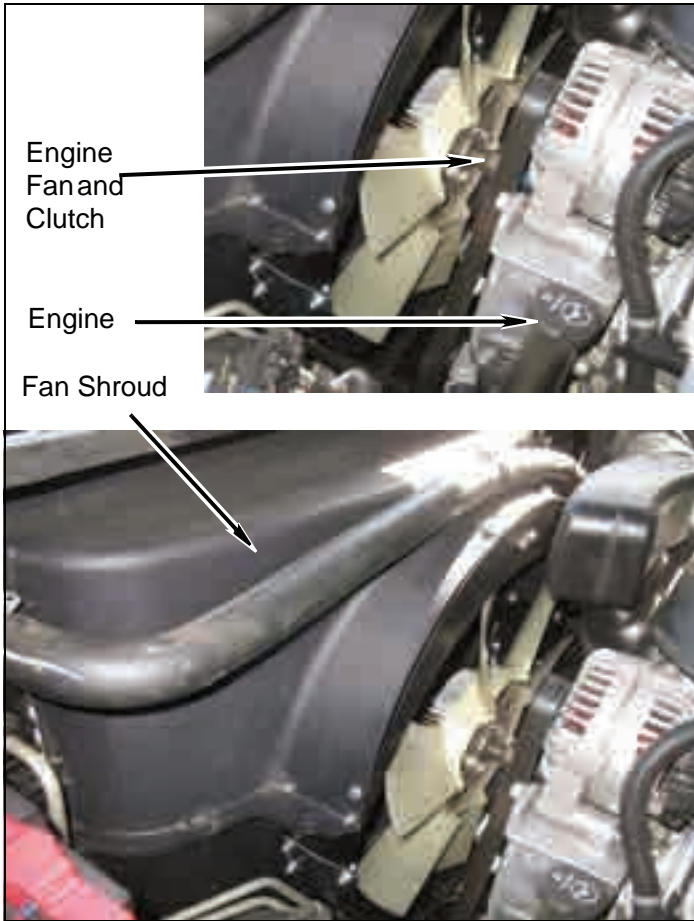

- m. Install two upper shroud bolts onto upper fan shroud and core support.



5. Air intake

- a. Reinstall air box into gromits

- b. Reinstall air box assembly and wiring harness.

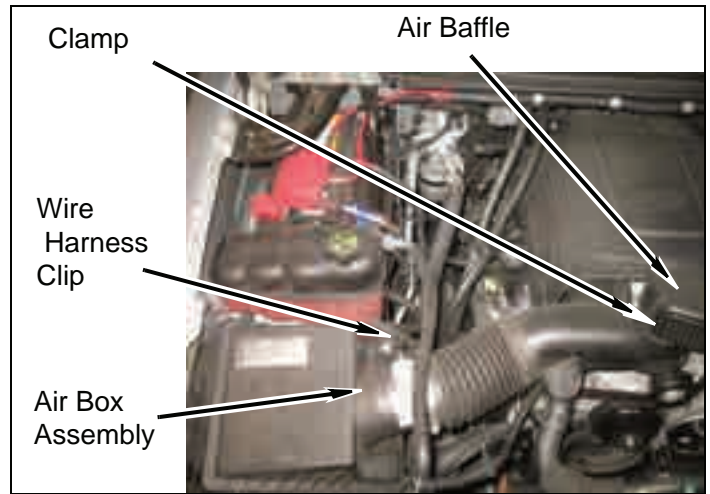

- c. Reinstall A/C hose into clip on upper fan shroud.

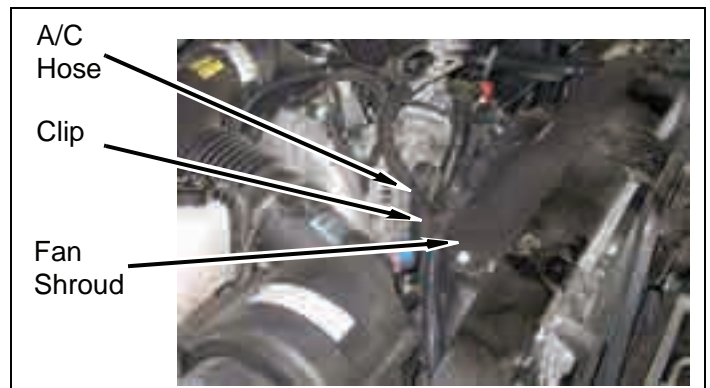

F. Front of vehicle

1. **Transmission cooler** (If so equipped)

- a. install two **kit 2" studded drop brackets** with O.E. bolts into nut clips from transmission cooler. Install two **kit 1/4" studded brackets** in holes on core support A-frame using **kit 1/4" nuts & washers**.

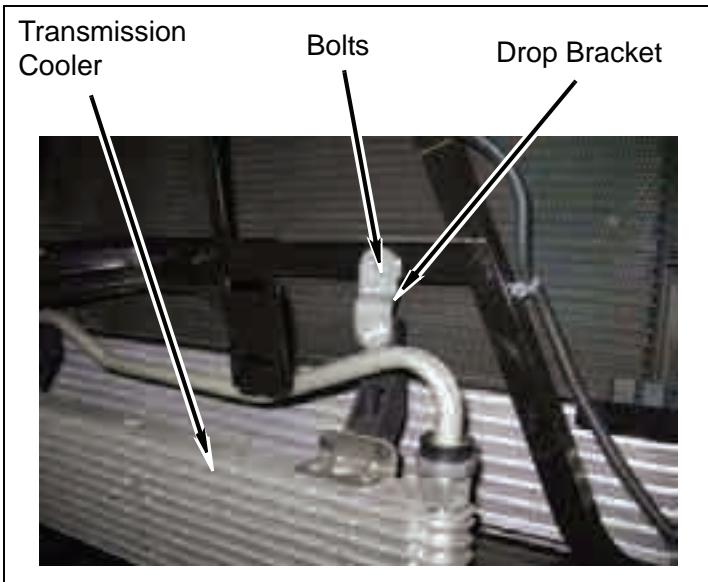

- b. Install two *kit Spacers* in between lower transmission cooler bracket and core support using *kit (3/8 x 2 1/2") hardware*.

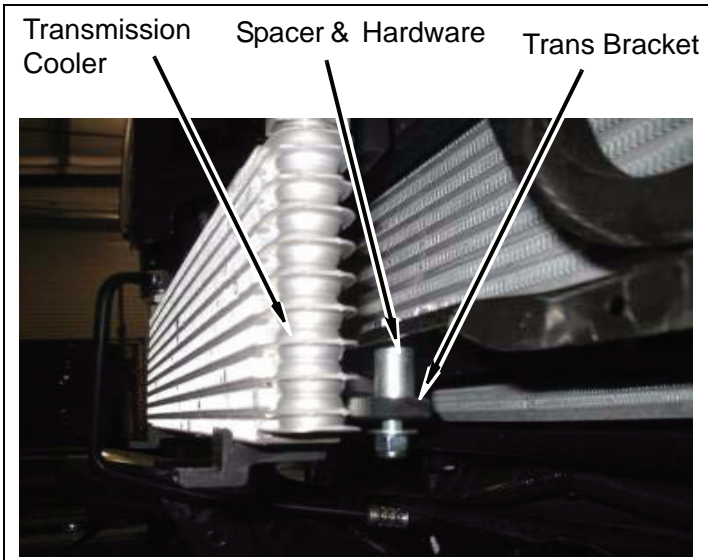

2. Plastic splash guard

- a. If removed, install clip and harness on air flap.
- b. Install plastic cover on frame and core support with five bolts.

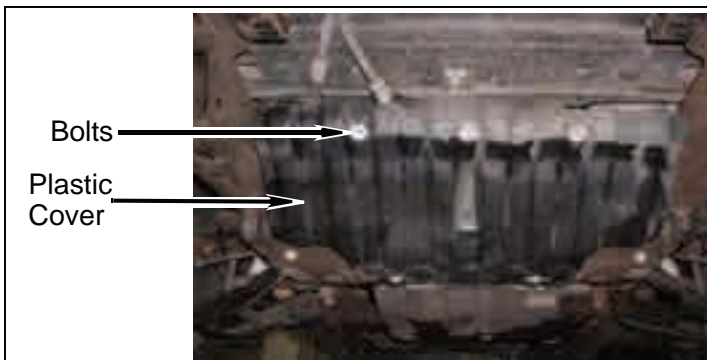

3. Install front bumper

- a. Place a few drops of kit Loctite® on threads of bolts.
- b. Install *kit bracket* (bumper, front, left) and *kit bracket* (bumper, front, right) onto left frame horn with four *kit washers* (1/2" x 1-3/8"), four *kit bolts* (1/2"-13 x 5-1/2"), eight *kit washers* (1/2" SAE) and four *kit nuts* (1/2"-13 Stover). DO NOT TIGHTEN.



NOTE

Kit washers (1/2" x 1-3/8") are fitted between *kit brackets* (bumper, front) and frame horn.

- c. Mark and remove small amount of front side bumper support so that **kit bracket**(side support) mounts flush against OEM bracket as shown:

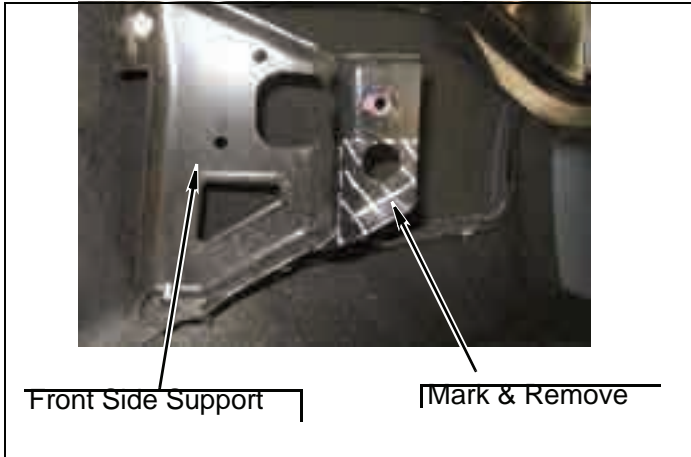

- g. Install two **kit brackets** (bumper, front, support) onto bumper with two **kit large washers** between bumper and kit bracket. **DO NOT TIGHTEN**

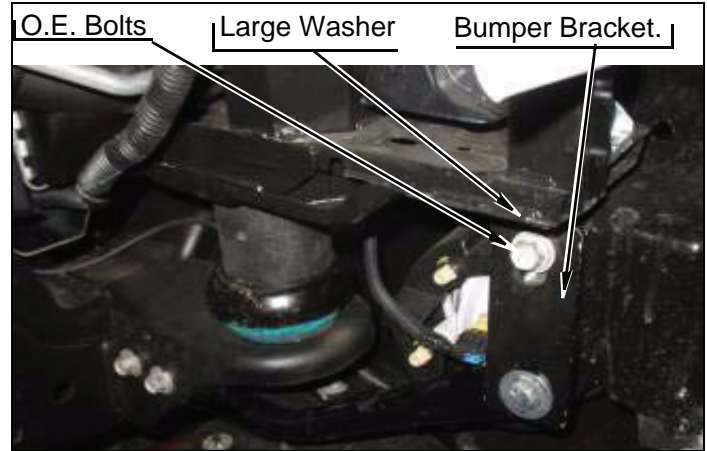

- d. Install frame bracket onto **kit brackets** (bumper, front) with two **kit sleeves** (.75" OD x .532" ID x 3.35" L), four **kit bolts** (1/2"-13 x 5-1/2"), eight **kit washers** (1/2" SAE) and four **kit nuts** (1/2"-13 Stover). **DO NOT TIGHTEN.**

- h. Install two bumper supports onto kit brackets with two **kit bolts** (7/16"-14 x 1-1/2"), four **kit washers** (7/16" SAE), two **kit nuts** (7/16"-14 Stover) with four O.E. bolts to body mount. **DO NOT TIGHTEN.**

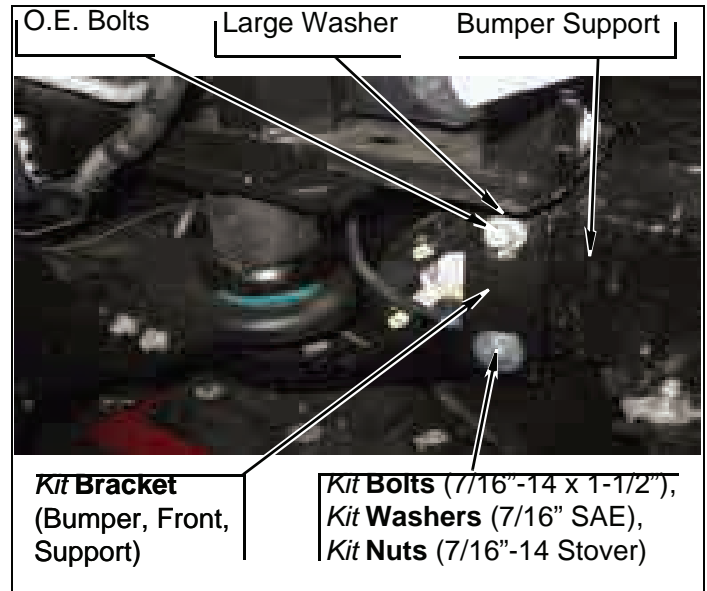
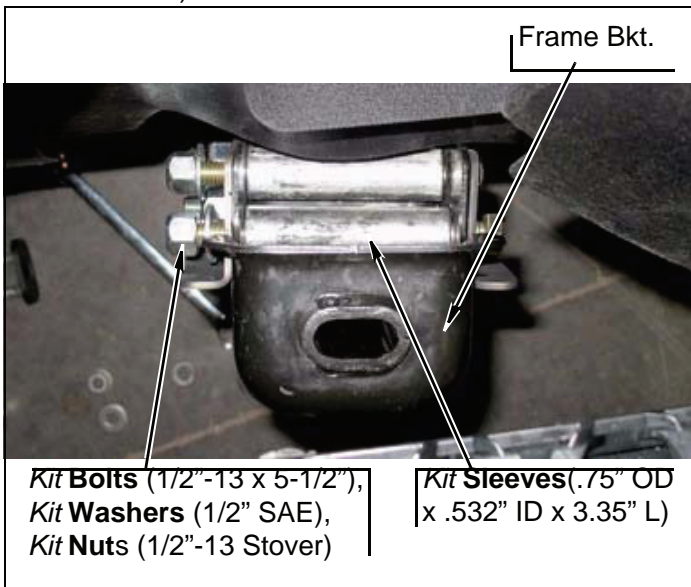

- e. Repeat above substeps for right frame horn.
 f. Install bumper onto frame brackets with two O.E. bolts. **DO NOT TIGHTEN.**

- i. Adjust bumper to body clearance using measurements from removal section. Align bumper to previous measurements and **TIGHTEN** all bumper hardware.

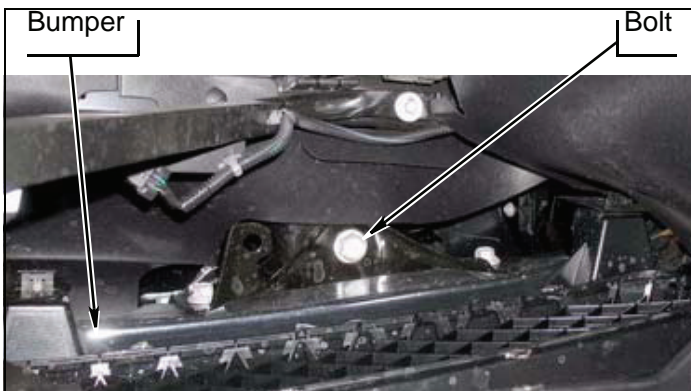

- j. If so equipped, install two connectors on two fog lamps.

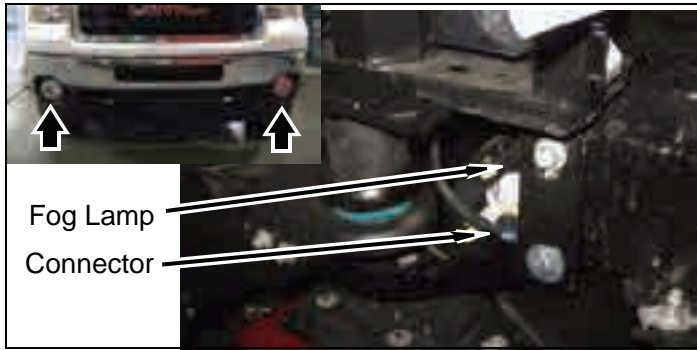

4. Install Front Grill

- a. Remove two bolts from each fender side and remove bumper face from core support and fenders .

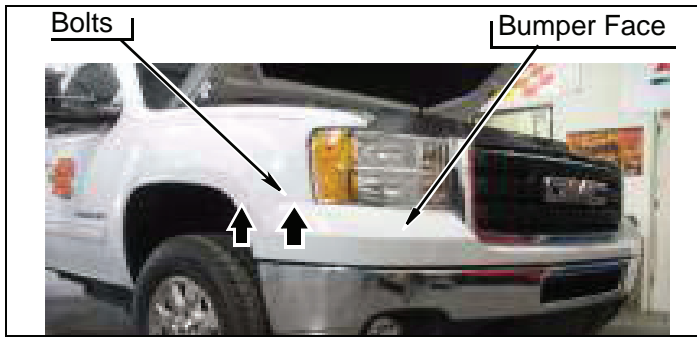

- b. Position grill on core support and install six clips and four bolts in core support and front fenders.



- c. Install cover on core support with seven push pins.

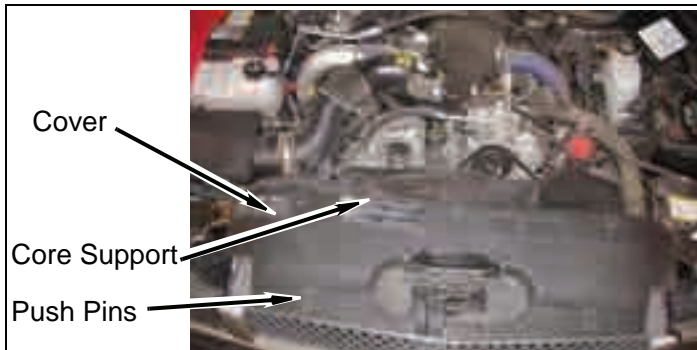

5. Install crush blocks

NOTE
Short wheel base trucks have two plastic disks and use two *kit* crush blocks.

- a. Remove four plastic disks from frame.
- b. Install four kit **crush blocks** on frame with four kit **washers** (5/16" USS) and four kit **screws** (5/16" x 3/4" self tapping).

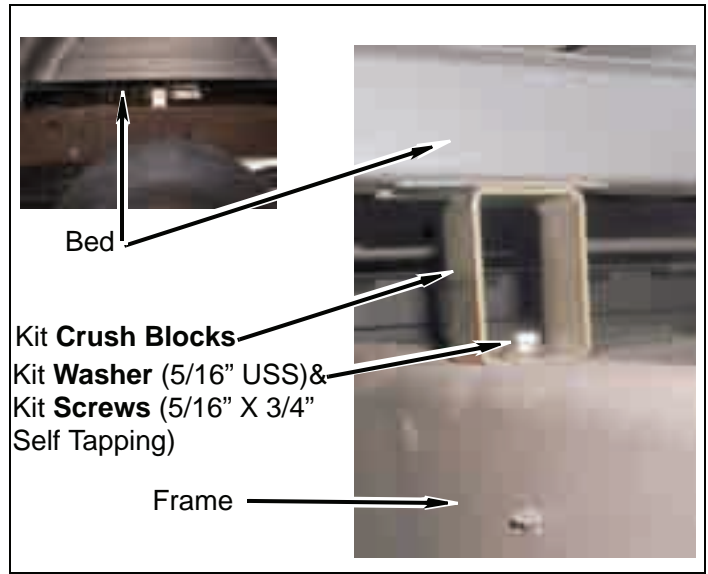

G. After installation is complete

- 1. Install airbag fuse in fuse panel. Install cover



2. Connect both battery cables to the battery. Be sure to reconnect the positive cables first, then the negative cables.

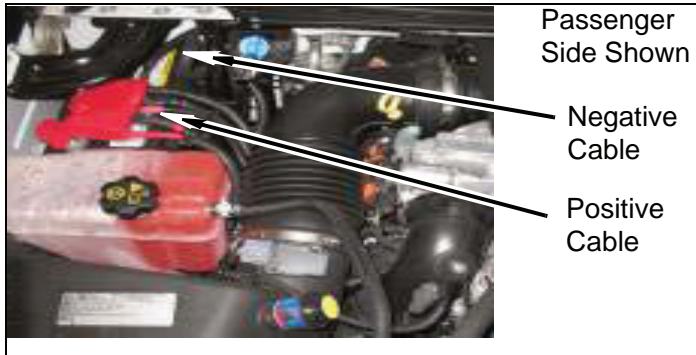

3. Install Gap Guards (you did remember to order your Gap Guards, didn't you?).
4. Stick kit **warning sticker** on the dash in plain sight of all vehicle occupants.
5. Double check the vehicle.

⚠CAUTION

Retorque all fasteners after 500 miles and after off road use. All body lift components should be visually inspected and fasteners re torqued during routine vehicle servicing.

- a. Check all mounting hardware to ensure it is properly tightened.
- b. Check all wires, hoses, cables, etc. to ensure they have been properly connected and there is ample slack. Check all belts and pulleys to ensure there is no rubbing or interference. With the number of hoses on this vehicle, it is vital that this be checked thoroughly.
- c. Check vehicle electrical system.
- d. Start vehicle and check the steering in both directions to ensure that there is no bind. Check clutch operation. Check the operation of the brake system and the parking brake. Check both shift levers' operation. Ensure that there is proper engagement in all gears and 4 wheel drive ranges.

⚠CAUTION

Never open a closed cooling system after the vehicle has been started. Only fill the cooling system if the cap has been removed while the vehicle was still cold.

- e. Check coolant level. Fill coolant to the proper level (refer to the Owner's Manual).
- f. Test drive vehicle in all gears and 4 wheel drive ranges. Pay close attention to all vehicle systems. Check all hardware again in 500 miles and as part of your regular maintenance schedule.

⚠NOTE

All warranty information, instruction sheets, and other documents regarding the installation of this product must be retained by the vehicle owner. Information contained in the instructions and on the warranty card will be required for any warranty claims. The vehicle owner needs to understand the modifications made to his vehicle and how they affect vehicle handling and performance. Failure to provide the customer with this information can result in damage to the vehicle and severe personal injury.

⚠CAUTION

Performance Accessories does not recommend any particular wheel and tire combinations for use with its body lifts and cannot assume responsibility for the customer's choice of wheels and tires. Reference your owner's manual for recommended tire sizes and warnings related to the use of oversized tires. Larger wheel and tire combinations increase stress and wear on steering and suspension components, which leads to increased maintenance and higher risk for component failure. Larger wheel and tire combinations also alter speedometer calibration, braking effectiveness, center of gravity, and handling characteristics. Consult with an experienced local off road shop to find what wheel and tire combinations work best with your vehicle.

PARTS LIST KIT 10263

QTY DESCRIPTION

| | |
|----|---|
| 4 | Bolt , 1/2 x 3 |
| 8 | Bolt , 1/2"-13x5-1/2" |
| 20 | Bolt , 1/4 x 3/4 |
| 8 | Bolt , 12-1.75 x 100mm |
| 2 | Bolt , 12-1.75 x 180mm |
| 6 | Bolt , 14-2.00 x 180mm |
| 2 | Bolt , 14-2.00 x 110mm |
| 2 | Bolt , 3/8 x 2 1/2 |
| 1 | Bolt , 3/8 x 1 3/4 |
| 16 | Bolt , 7/16 x 1 1/2 |
| 2 | Bracket , shroud drop |
| 2 | Bracket , upper fan |
| 2 | Bracket , lower fan |
| 2 | Bracket , front bumper driver side |
| 2 | Bracket , front bumper outer |
| 2 | Bracket , front bumper passenger side |
| 1 | Bracket , rear bumper driver side |
| 1 | Bracket , rear bumper passenger side |
| 1 | Bracket , hitch spacer |
| 2 | Bracket , bent & studded 2" , transmission drop |
| 1 | Bracket , studded 3" ground strap |
| 3 | Bracket , L-shape, shroud anchore |
| 4 | Crush block with hole |
| 1 | Label , logo |
| 1 | Label , warning |
| 1 | Loctite , 6ml |
| 12 | Nut , 1/2-13 Nylock |
| 24 | Nut , 1/4 Nylock |
| 2 | Nut , 14mm Nylock |
| 3 | Nut , 3/8 Nylock |
| 4 | Nut , 7/16 Nylock |
| 1 | Pin , 4x4 extension, 1/2" X 1" |
| 4 | Screw , 5/16 x 3/4, self-tapping |
| 16 | Lift block, 3" height x 3" diameter w/ 5/8" Hole |
| 4 | Sleeve , .75" ODx.532" IDx3.35" L |
| 4 | Sleeve , 5/8" x 1.5" L, transmission spacer |

| | |
|----|---|
| 1 | Steering extension |
| 10 | Washer , 1/2"x1-3/8", Thick |
| 16 | Washer , 1/2" USS |
| 44 | Washer , 1/4" SAE |
| 10 | Washer , 14mm |
| 2 | Washer , 3/16" x 1 1/2" x 2 1/2" |
| 2 | Washer , 3/8" SAE |
| 4 | Washer , 3/8" USS |
| 4 | Washer , 5/16" USS |
| 16 | Washer , 7/16" USS |
| 8 | Washer , 7/16" SAE |
| 5 | Zip tie |

Copyright 2013
Performance Automotive Group