



841 S. 71st Avenue • Phoenix, AZ 85043  
(623) 907-0081  
www.performanceaccessories.com

**CHEVORLET SILVERADO**  
**1500 \*\*ONLY\*\***  
**GAS ENGINE**  
**3" BODY LIFT KIT INSTALLATION**  
**INSTRUCTIONS 2016-2017**  
**KIT# PA10343**

**⚠ WARNING**  
This kit should only be installed on a vehicle that is in good working condition. Before you install the kit, thoroughly inspect the vehicle for corrosion or deformation of the sheet metal around the factory body mounts. If the vehicle is suspected to have been in a collision or misused, do not install this kit. Off-road use of your vehicle with this kit installed may increase the stress applied to the factory body mounts. We do not recommend that any vehicle with a body lift kit installed be involved in any extreme off-road maneuvers such as jumping. Failure to observe this warning may result in serious personal injury and/or severe damage to your vehicle.

**⚠ WARNING**  
Installation of a Performance Automotive Group body lift kit will change the vehicle's center of gravity and handling characteristics both on- and off-road. You must drive the vehicle safely! Extreme care must be taken to prevent vehicle rollover or loss of control, which could result in serious injury or death. Avoid sudden sharp turns or abrupt maneuvers and always make sure all vehicle occupants have their seat belts fastened.

**⚠ WARNING**  
Many states and municipalities have laws restricting bumper heights and vehicle lifts. Consult state and local laws to determine if the changes you intend to make to the vehicle comply with the law.

**⚠ WARNING**  
Before you install this kit, read and understand all instructions, warnings, cautions, and notes in this instruction sheet and in the vehicle owner's manual.

**⚠ WARNING**  
The installation of larger tires may reduce the effectiveness of the braking system.

**⚠ CAUTION**  
Proper installation of this kit requires knowledge of the factory recommended procedures for removal and installation of original equipment components. We recommend that the factory shop manual and any special tools needed to service your vehicle be on hand during the installation. Installation of this kit without proper knowledge of the factory recommended procedures may affect the performance of these components and the safety of the vehicle. We strongly recommend that a certified mechanic familiar with the installation of similar components install this kit.

**⚠ WARNING**  
Always wear eye protection when operating power tools.

**⚠ WARNING**  
DO NOT combine suspension, body, or other lift devices. Use of vehicle with combined lifts may result in unsafe and/or unexpected handling characteristics.

**⚠ WARNING**  
Before you install this kit, block the vehicle tires to prevent the vehicle from rolling.

**⚠ WARNING**  
Accidental deployment of the air bag can result in serious personal injury or death. To avoid accidental deployment during installation of the kit, the Supplemental Restraint System (SRS, or airbag) must remain deactivated. Do not allow anyone near the airbag during installation. Refer to the factory service manual or owner's manual for the recommended procedure to disable the SRS. After you install the kit, reactivate the SRS before driving the vehicle.

**NOTE**  
Performance Automotive Group recommends using the Loctite® supplied in the kit on the threads of all kit nuts and bolts unless specified otherwise in these instructions.

# Before Starting Installation

**NOTE**  
Kit parts are prefaced by the word *kit* and appear in **bold** print.

1. Carefully read all warnings and instructions completely before beginning.
2. Verify all parts have been received in this kit by checking the parts list at the end of this document.

**NOTE**  
If parts are missing from kit, please be prepared to provide the following information:  
1. **Name** of purchase location  
2. **Bar Code** on side of box  
3. **Date** above bar code  
4. **Date** inside box cover  
5. **Inspector #** from inside box cover

3. **Only install this kit on the vehicle for which it is specified.** If anytime during the installation you encounter something different from what is outlined in the instructions, call technical support at (928) 636-7080.
4. Special tools needed:
  - a. Die grinder or plasma torch capable of cutting metal and plastic.
  - b. 3/8" and 1/2" drill bit
  - c. Center punch set
  - d. Telescoping magnet
  - e. \*Welding required\* (Manual Transfer Case Only)
5. Park vehicle on a clean, dry, flat, level surface and block tires so vehicle cannot roll in either direction.

## Engine Compartment

1. Disconnect both battery cables. Disconnect negative cable first, then positive cable.
2. Airbag Fuse

**NOTE**  
The location of the airbag fuse may vary; check the owner's manual.

- a. Remove fuse cover.
- b. Remove airbag fuse.

# Prepare to Install Kit

## Measurements

1. Measure and record distance between front bumper and fenders.  
Driver Side \_\_\_\_\_ Passenger Side \_\_\_\_\_
2. Measure and record distance between rear bumper and bed  
Driver Side \_\_\_\_\_ Passenger Side \_\_\_\_\_
3. Measure and record distance between cab and bed.  
Driver Side \_\_\_\_\_ Passenger Side \_\_\_\_\_

## Front of Vehicle

1. Front Bumper
  - a. Remove clips and cover from core support and grille.

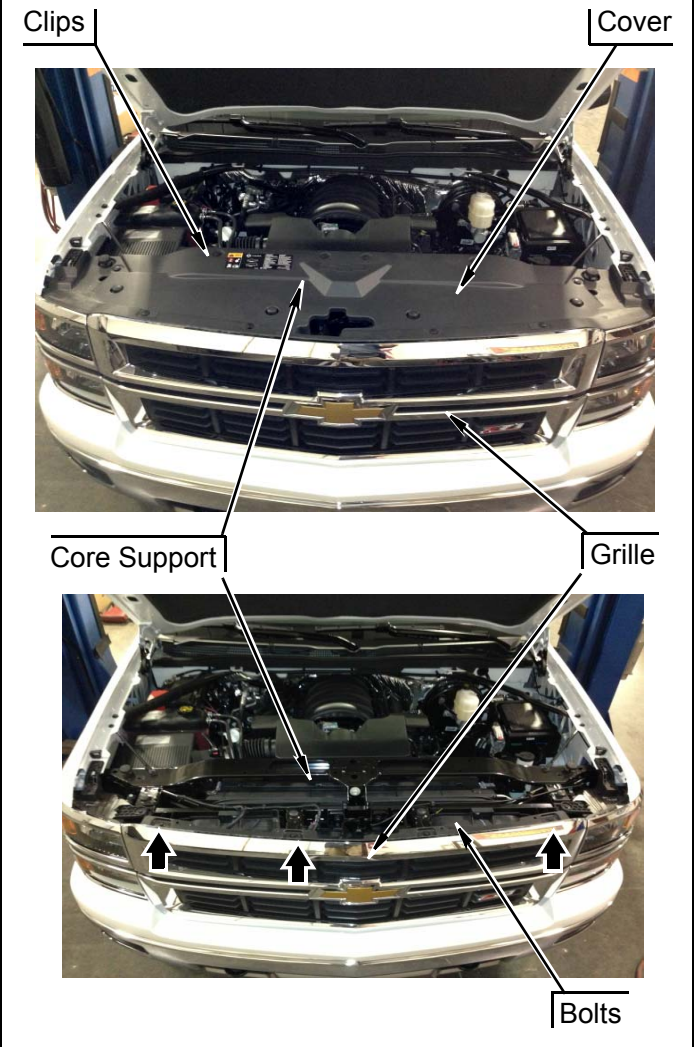



- b. Remove four screws from upper grille and unclip two lower clips from lower grille as you prepare to remove grille from core support.
- c. Remove two bolts from side fascia in inner fender wells with a 7mm socket in each fender well.

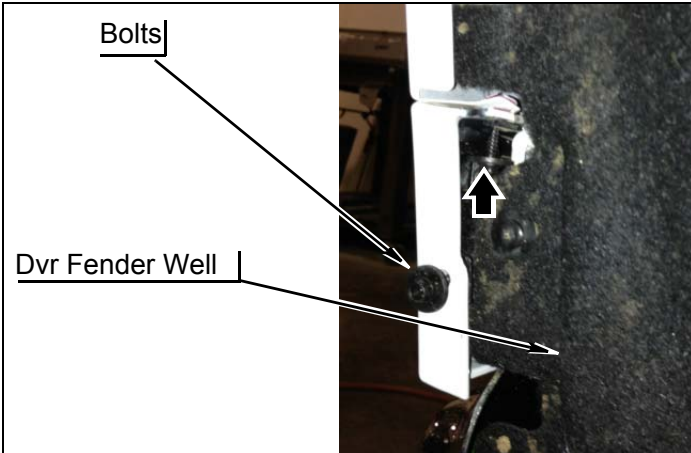

- d. Remove four bolts from lower grille fascia with a 10mm socket on back-inside of lower grille.

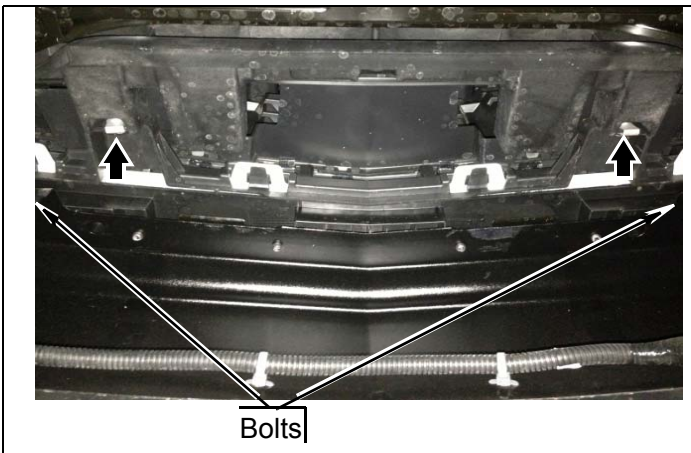

- e. Disconnect fog lamp connectors from bumper, if equipped.

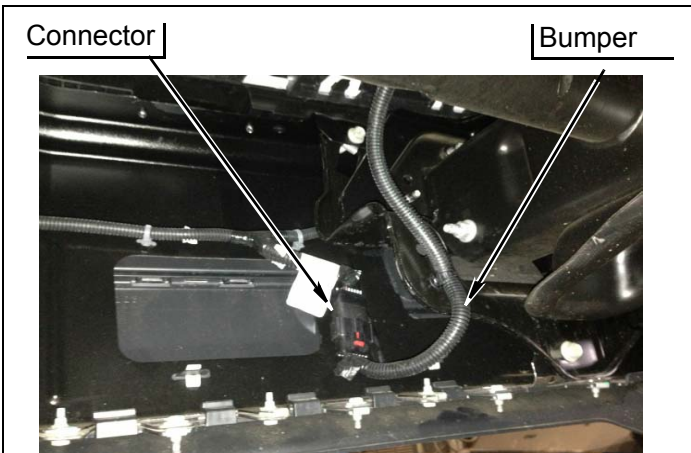

- f. Remove grille from core support.

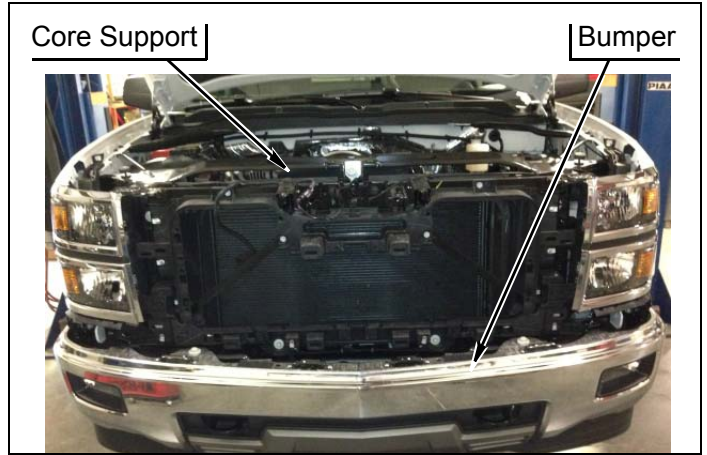

- g. Loosen three bolts and remove both bumper supports from each cab mount and bumper.

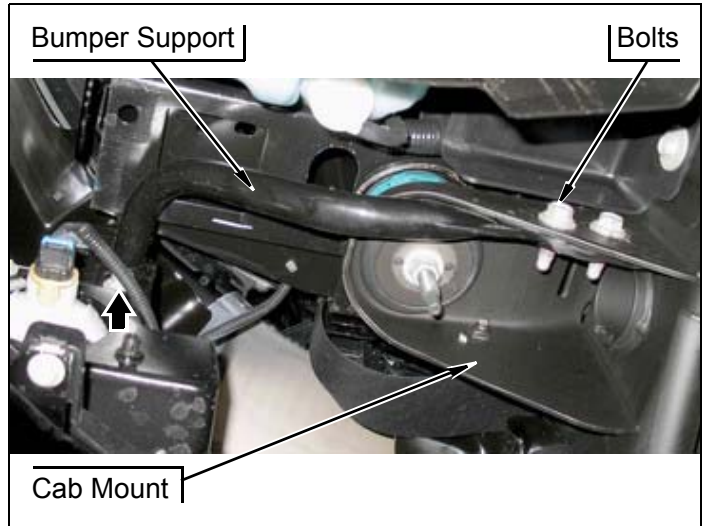

- h. Remove four bolts and bumper from frame horns.

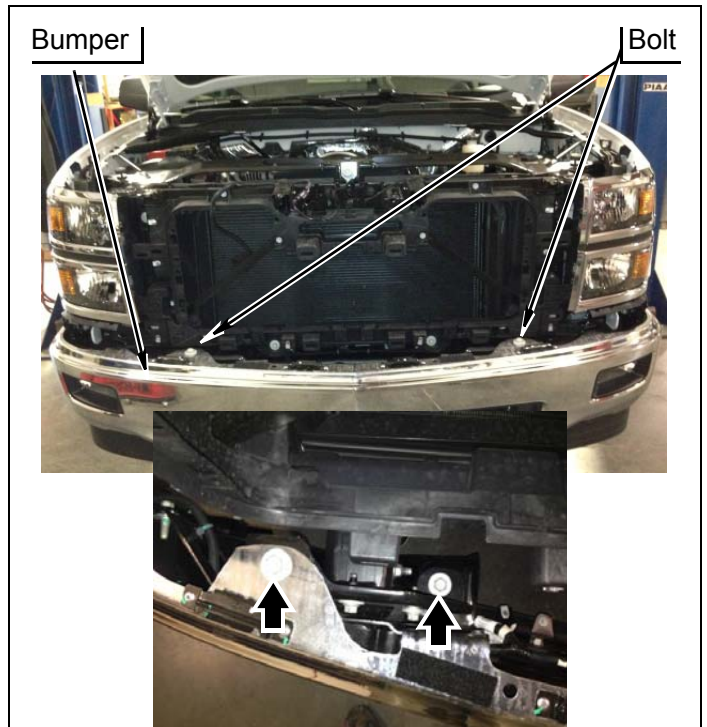



- i. Remove six nuts and two bumper frame brackets from frame horns.

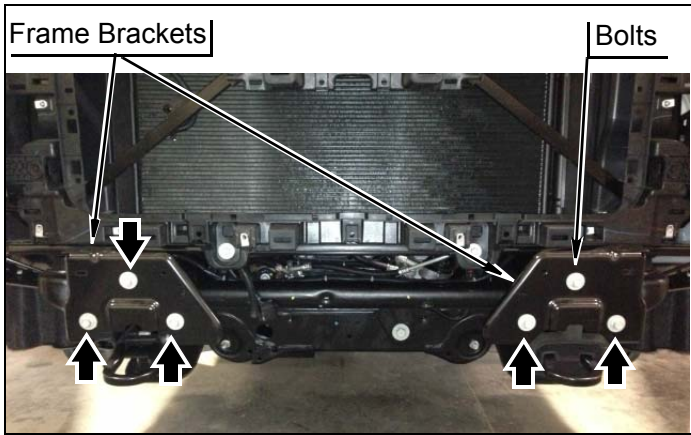

- j. Remove four bolts, two nuts and two tow hooks from frame horns.

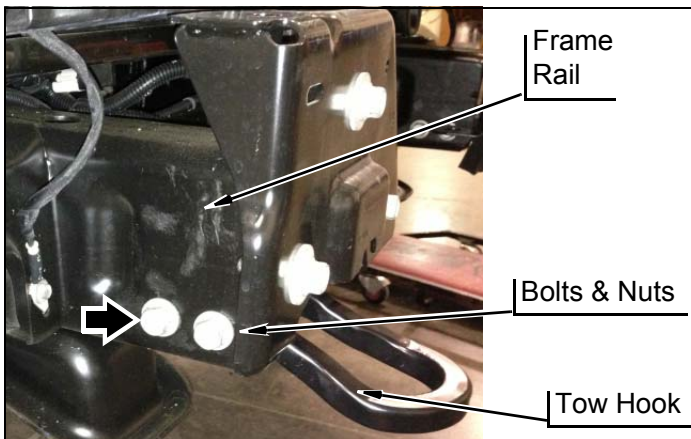

- k. Remove six bolts attaching lower guard to core support and frame. Remove guard.

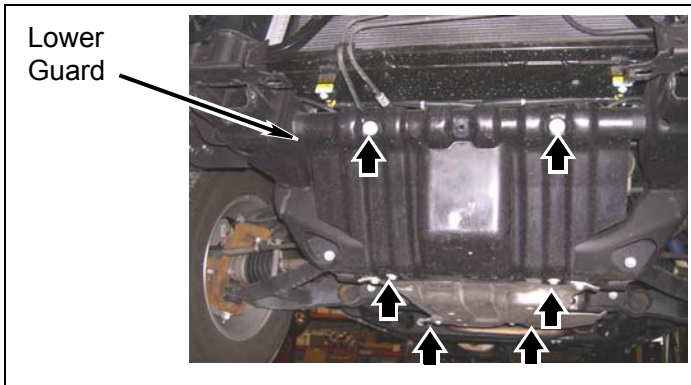

- l. Remove ground strap bolts from body mounts.

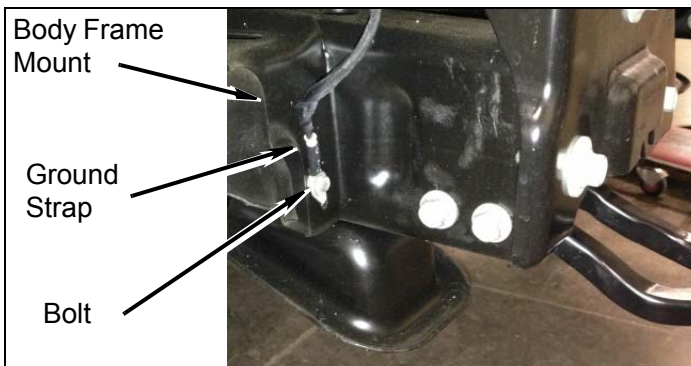

## Engine Compartment

### 1. Air intake

- a. Pull up and remove cover from engine if equipped.

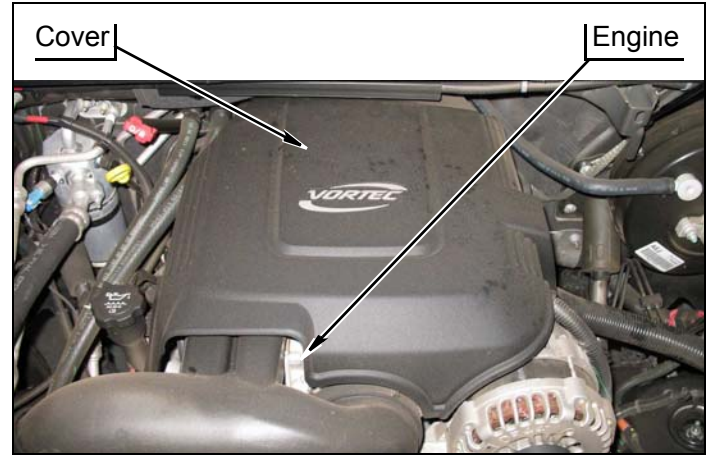

- b. Loosen two clamps on airbox and engine intake.

- c. Remove clip and upper radiator hose from engine intake.

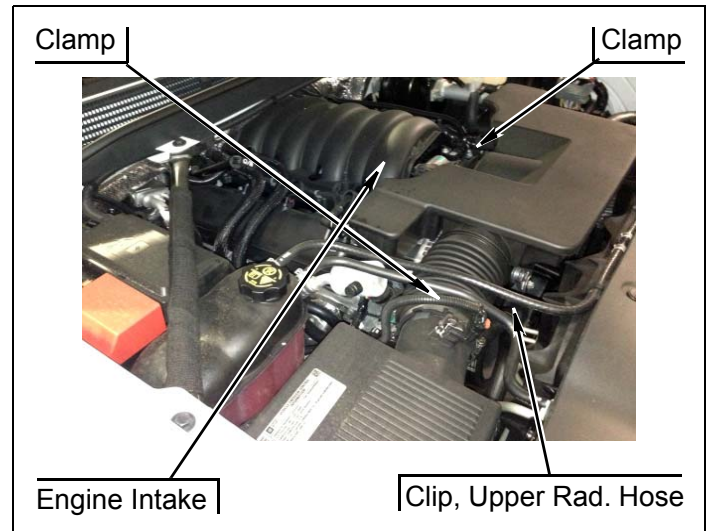

- 2. Remove nut and ground strap from left firewall.

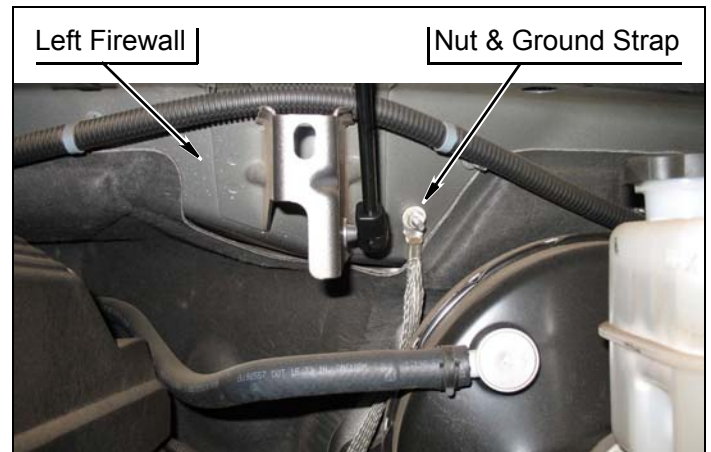

- Remove brake lines from left frame rail and two clips.

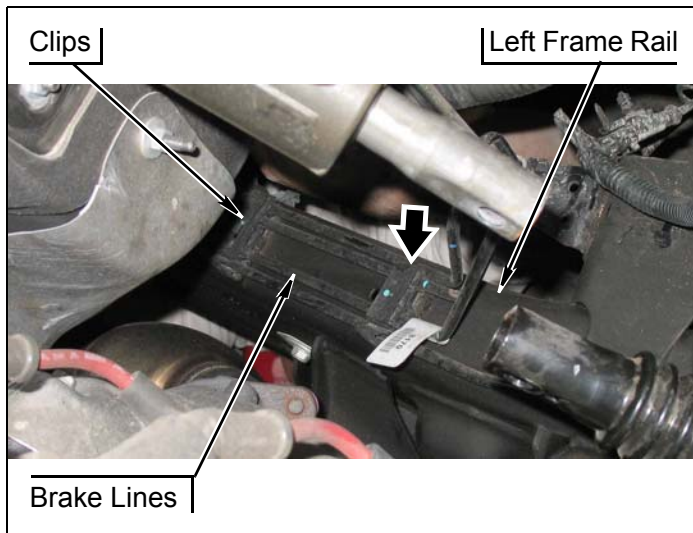

- Remove left harness and clip from left firewall bracket, below brake master cylinder.

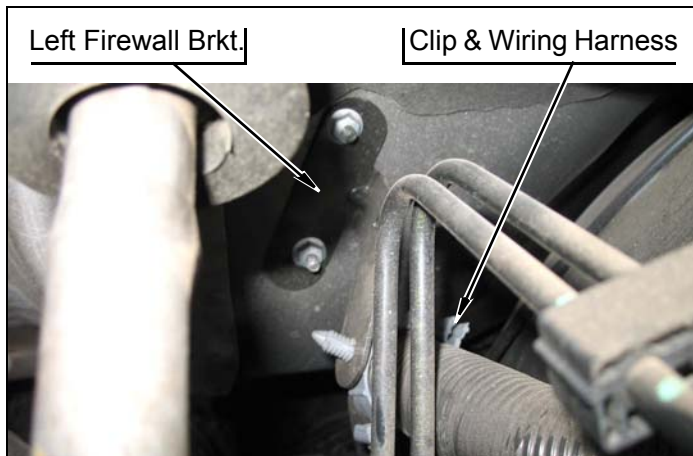

- Remove harness from left wheel well, below fuse box.
- Remove harness and clip from fuse box.

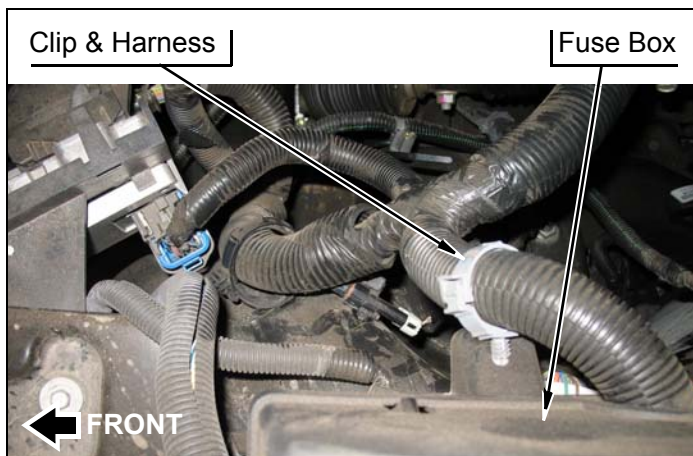

## 7. Steering Shaft

### ⚠ WARNING

Accidental deployment of the air bag can result in serious personal injury or death. To avoid accidental deployment during installation of the lift kit, the Supplemental Restraint System (SRS, or airbag) must remain deactivated. Do not allow anyone near the airbag during installation. Refer to the factory service manual or owner's manual for the recommended procedure to disable the SRS. After kit installation, the SRS must be reactivated before driving the vehicle.

### ⚠ CAUTION

If the following step is not performed, the airbag clockspring could be damaged. Do not turn the steering wheel while the steering shaft is disconnected.

- Strap steering wheel to prevent accidental movement.
- Mark upper steering shaft in relation to rack and pinion as shown.
- Remove bolt and upper steering shaft from rack and pinion.

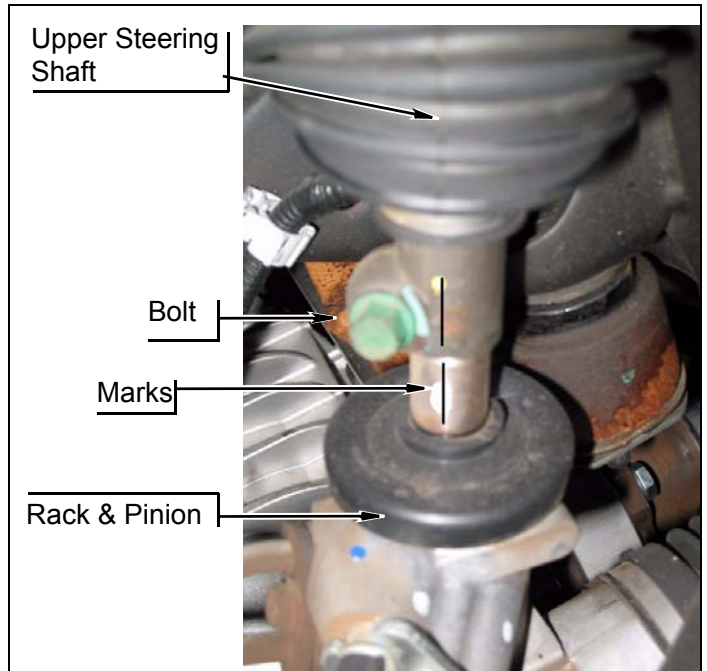



## Underside of Vehicle

1. Remove bolt, metal clip and harness from right frame rail.

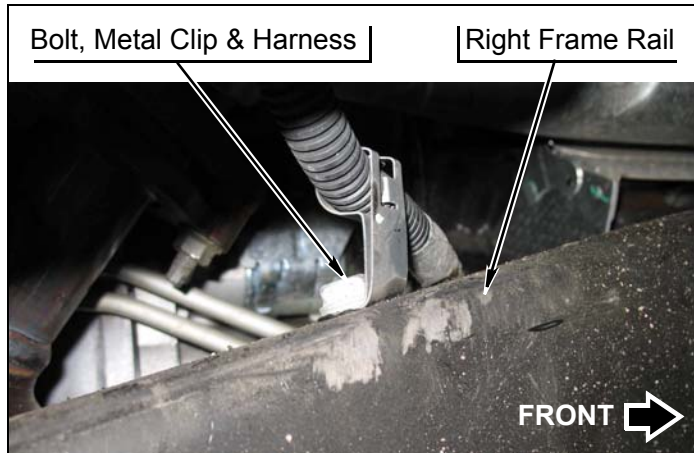

2. Remove clip and harness from left frame rail.

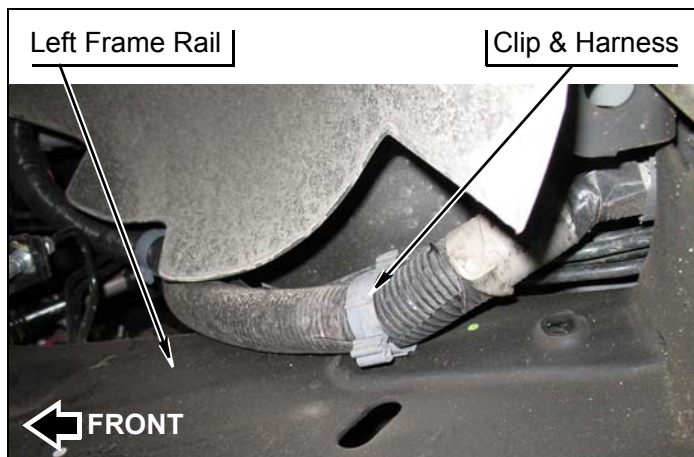

3. Parking brake cable

- a. Using locking pliers, pull slack into rear cable.
- b. Disconnect cable at junction near left frame rail.

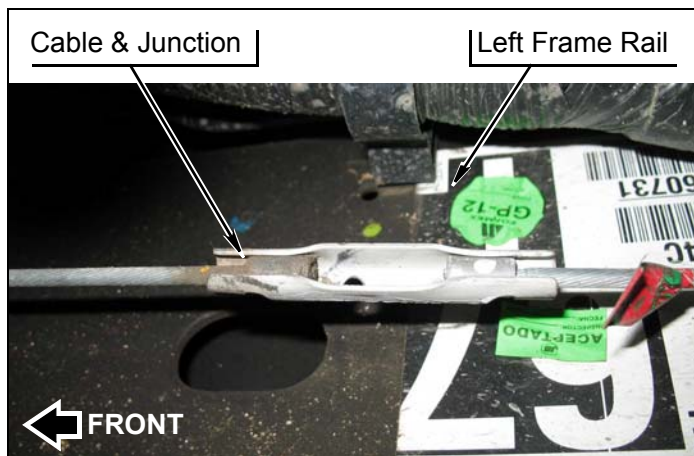

- c. Remove front cable from left frame body mount.

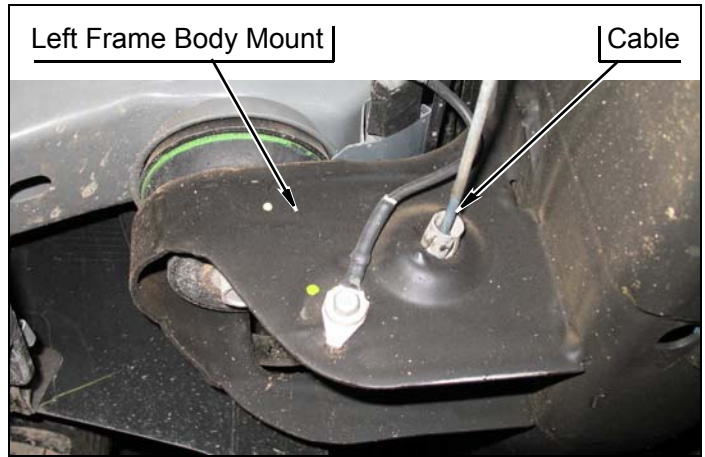

4. Remove bolts and ground straps from front left (Dvr), front right (Psg) frame, second left (Dvr) body mount, and second right (Psg) body mount.

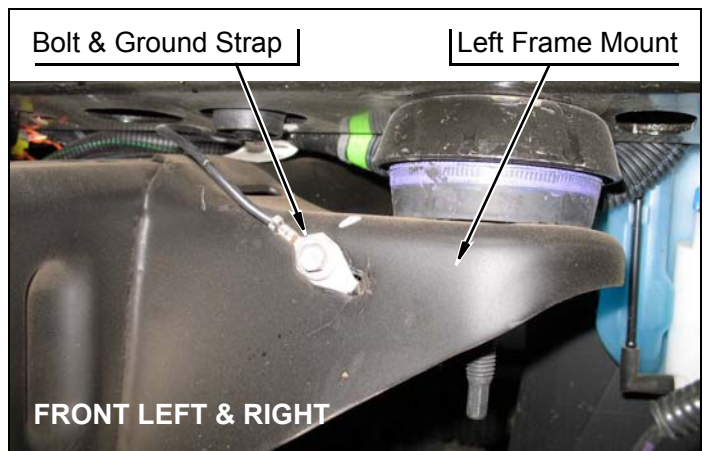

5. Remove bolt, metal clip and harness from right front frame rail.

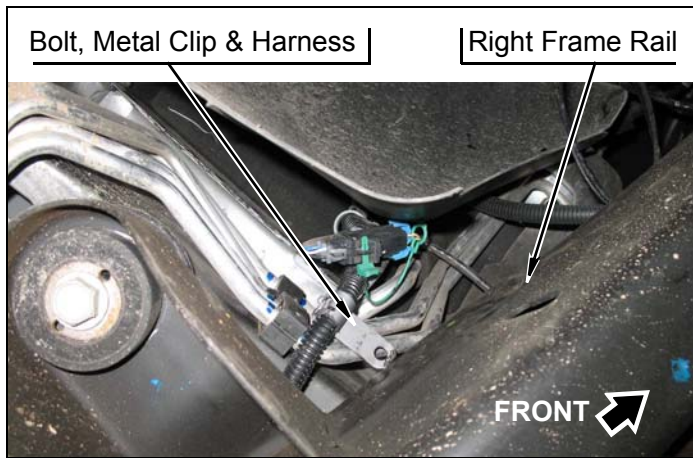

6. **Manual transfer case:** shift linkage

- a. Remove clip containing three metal lines from bracket.

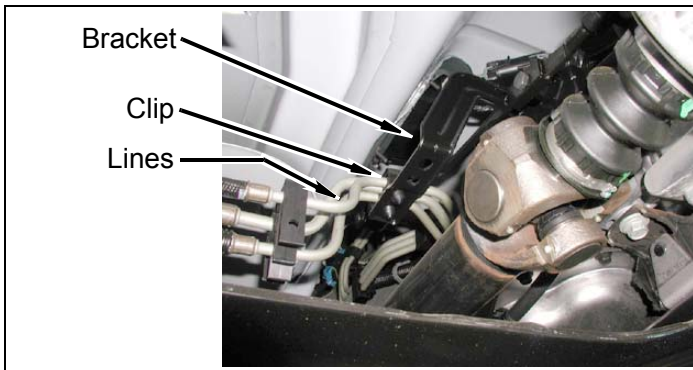

- b. Remove two nuts and bracket from transfer case. Bracket is not reused. Install two nuts and tighten.

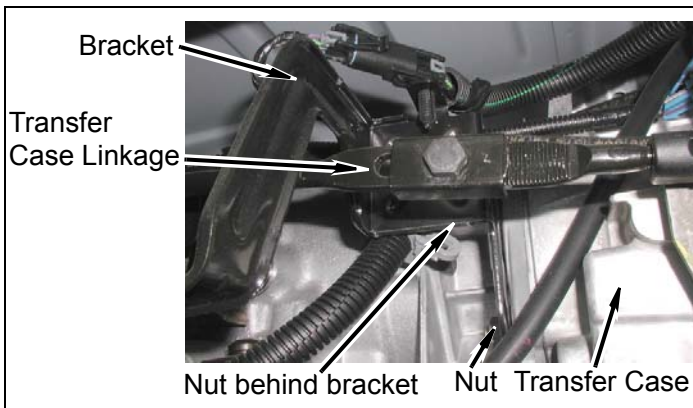

- c. Remove two clips and transfer case linkage from transfer case and pivot.

## Rear of Vehicle

1. Remove three bolts and fuel filler from bed side.

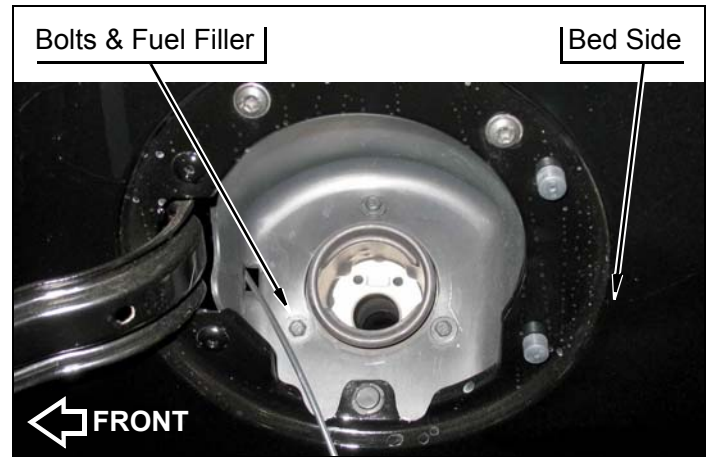

2. Rear bumper

- a. Remove black wiring harness from junction on rear crossmember. (Above blue plug harness)

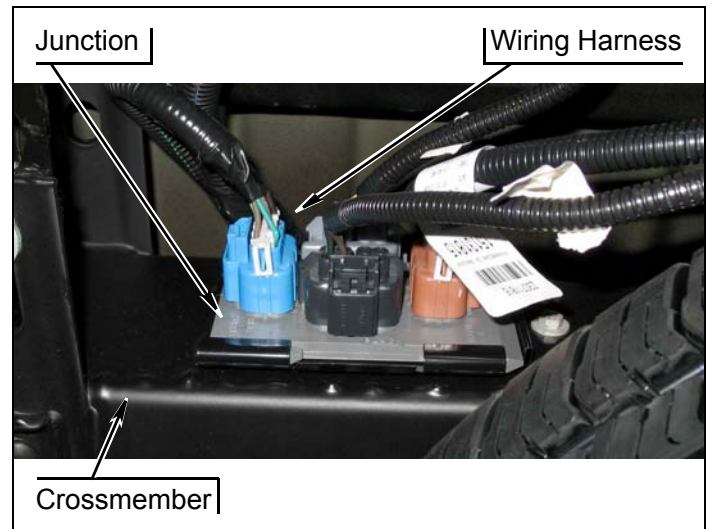

- b. Remove trailer light harness from bumper.

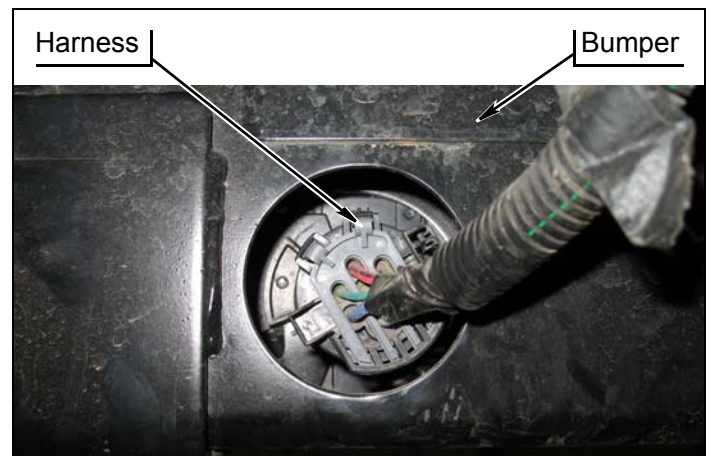



- c. Remove four nuts, two double-bolt fasteners, four bolts and bumper from frame rails.

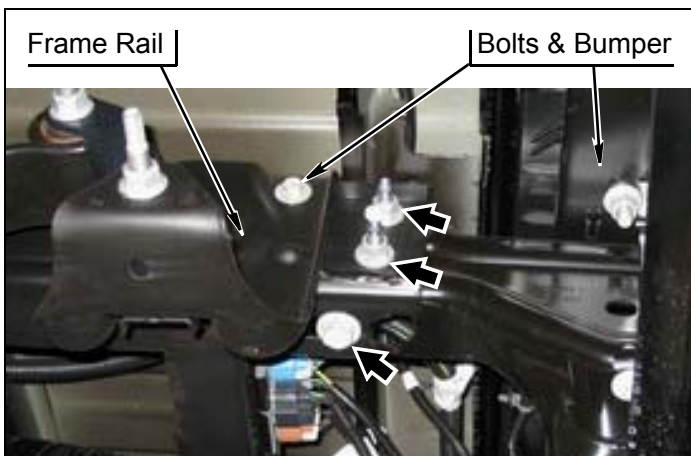

- d. If equipped with a trailer hitch, remove two short and two long bolts from hitch and frame.

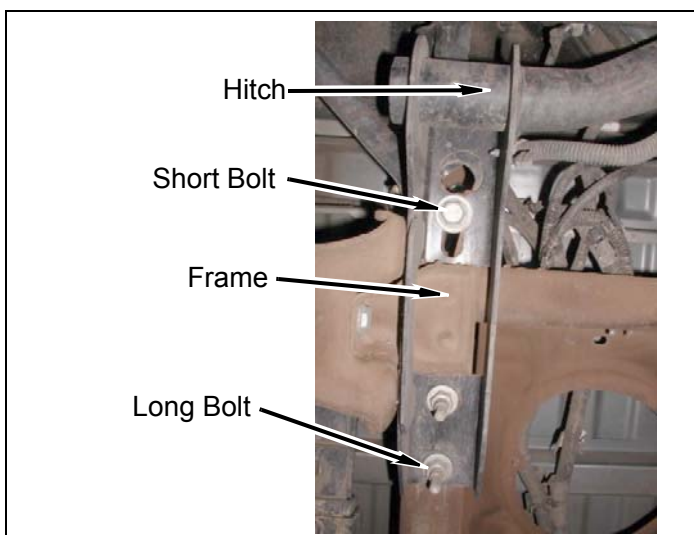

- e. Remove two bolts and bumper from hitch and vehicle.

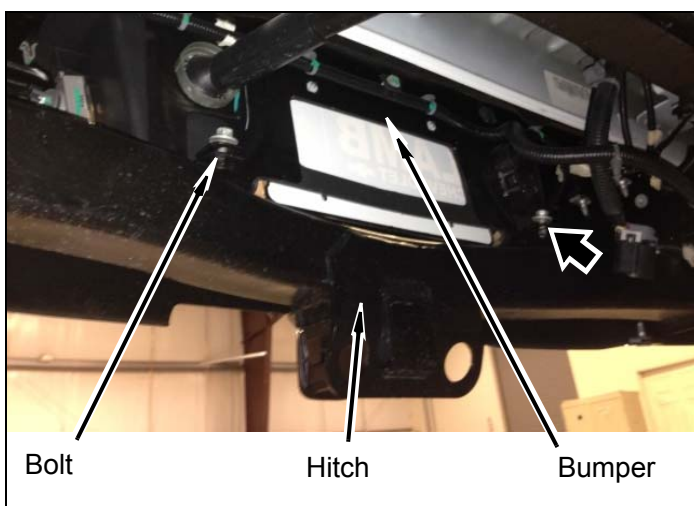

## Install Kit

### Cab

1. Prepare to lift cab from frame

- a. Loosen, but DO NOT REMOVE, cab mounting bolts on left side.

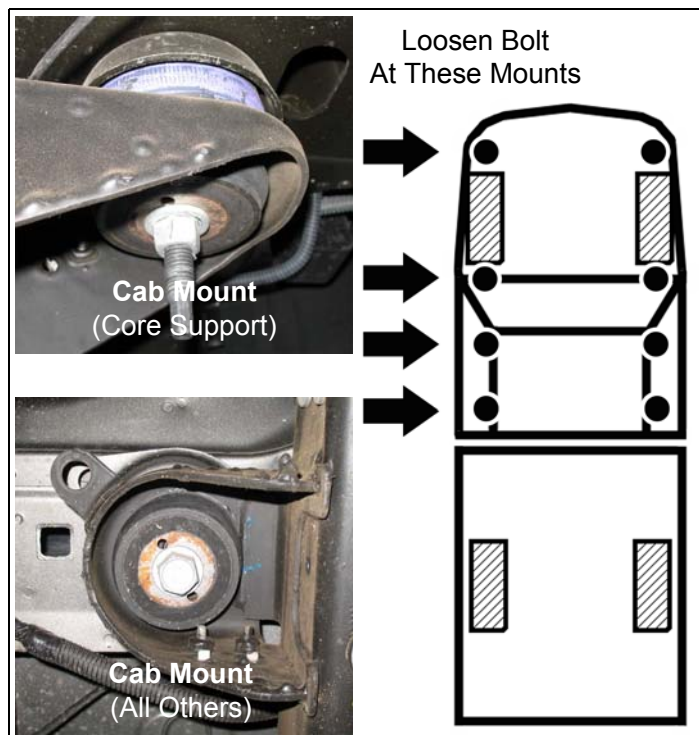

- b. Remove bolt (and nut for core support) and lower bushing from each cab mount on right side.

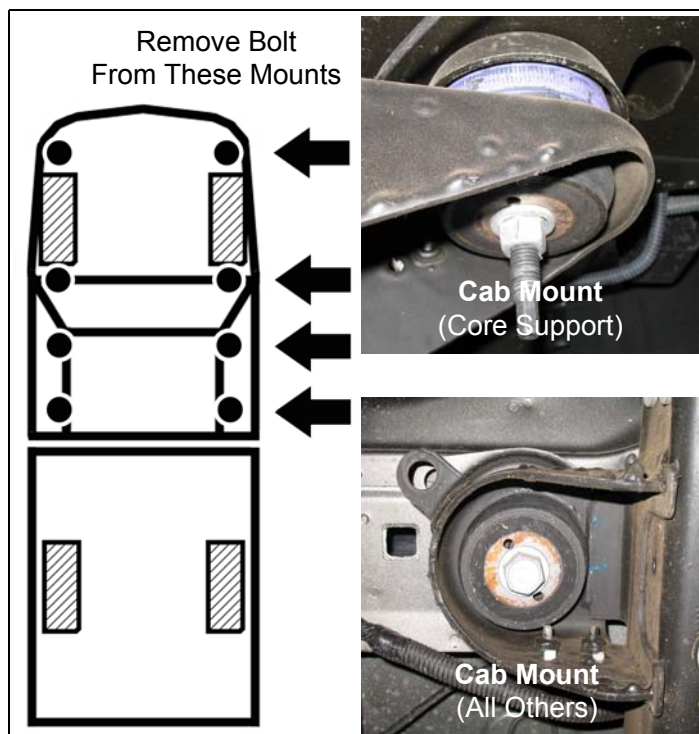



**⚠ WARNING**

Use extreme caution when lifting body from frame. To prevent serious personal injury, ensure the lifting device is securely placed. Keep your hands out from between the body and frame.

**⚠ CAUTION**

Continually check hoses, wires, lines, etc. to be sure that everything is flexing properly and not binding, or damage to the vehicle could result. Be especially careful of the a/c hoses at the fire wall, the belt pulley, and at the core support. Ensure brake lines stretch while lifting. Bending the lines to gain ample slack may be necessary. Be extremely careful not to kink the lines.

**2. Right side of cab**

- a. Position a hydraulic floor jack and wood block(s) under right side of cab (under the body seam). Slowly lift cab just enough to install a **kit block** on top of factory upper bushing.

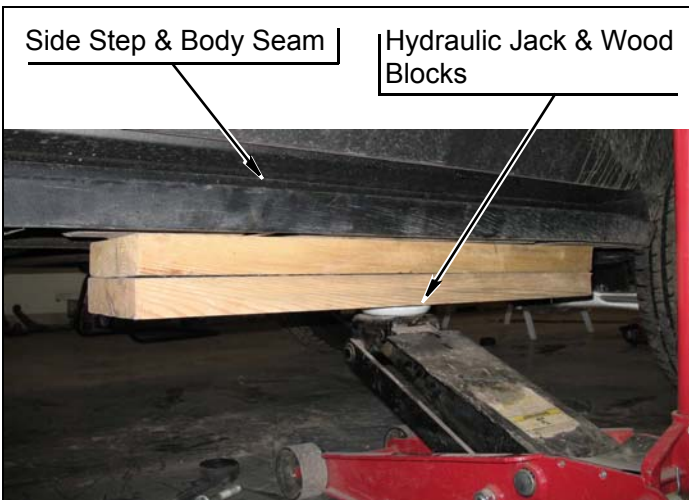

**⚠ WARNING**

The **kit blocks** must be installed in addition to the factory upper and lower bushings. Installing the **kit blocks** without the factory upper and lower bushings could result in damage to the vehicle or serious personal injury.

- b. Remove plastic sleeves from all upper bushings.

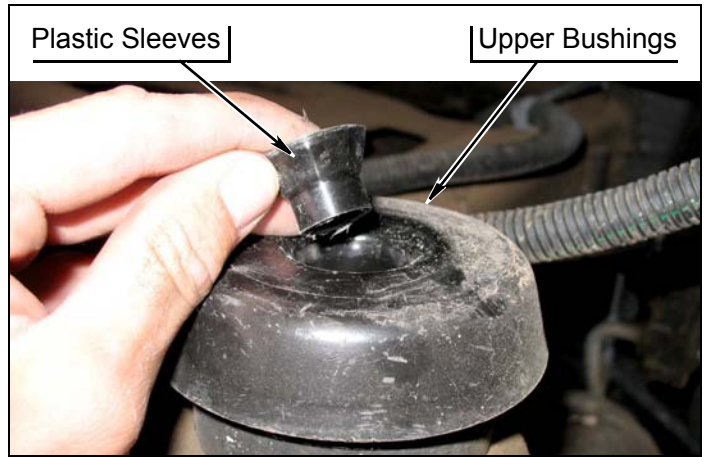

- c. Install **kit blocks** onto upper bushings on each cab mount.

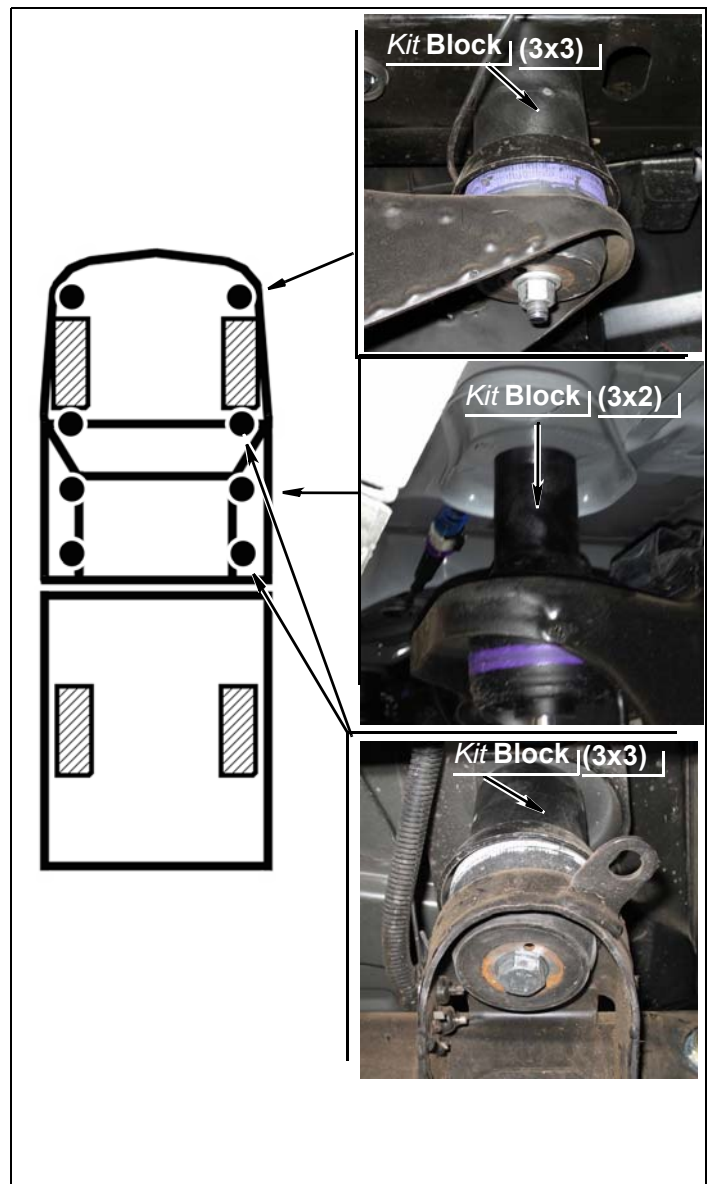

- d. Lower cab onto **kit blocks**.

- e. Install **kit bolt** (M12-1.75 x 200mm), **thick washer** and O.E. nut into core support cab mount and **kit block**. DO NOT TIGHTEN.

(Note: Use a magnet from top of core support to remove OE bolt and install kit **bolt** (M12-1.75 x 200mm) & **thick washer**.)

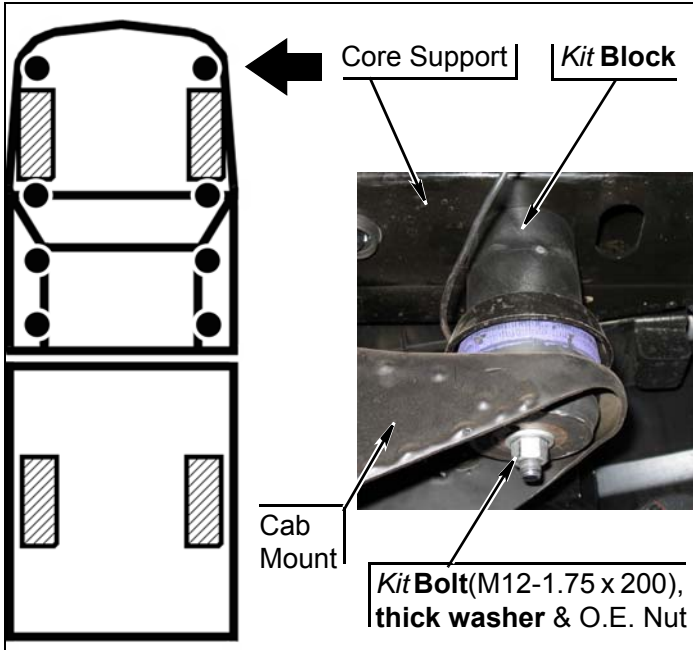

- f. Install **kit bolt** (M14-2.0 x 210mm) into cab mounts and **kit blocks**. DO NOT TIGHTEN.

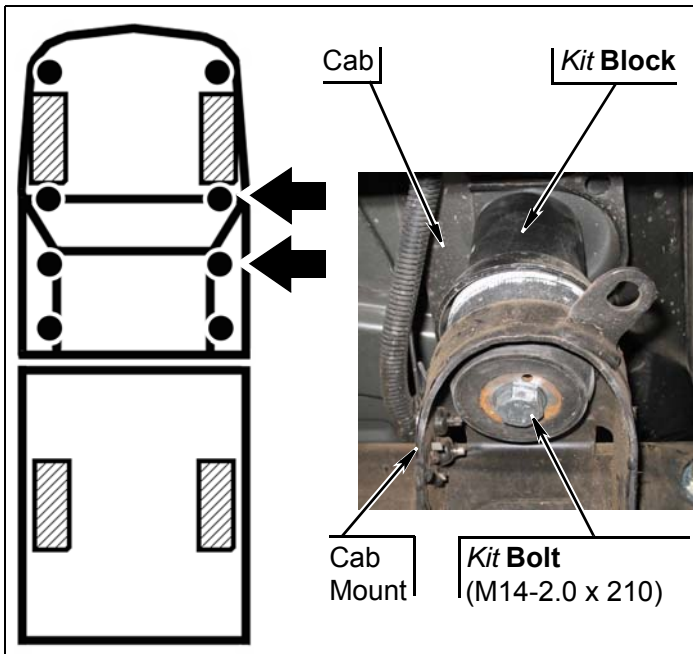

- g. Install **kit bolt** (M14-2.0 x 180mm) into remaining cab mounts and **kit blocks**. DO NOT TIGHTEN.

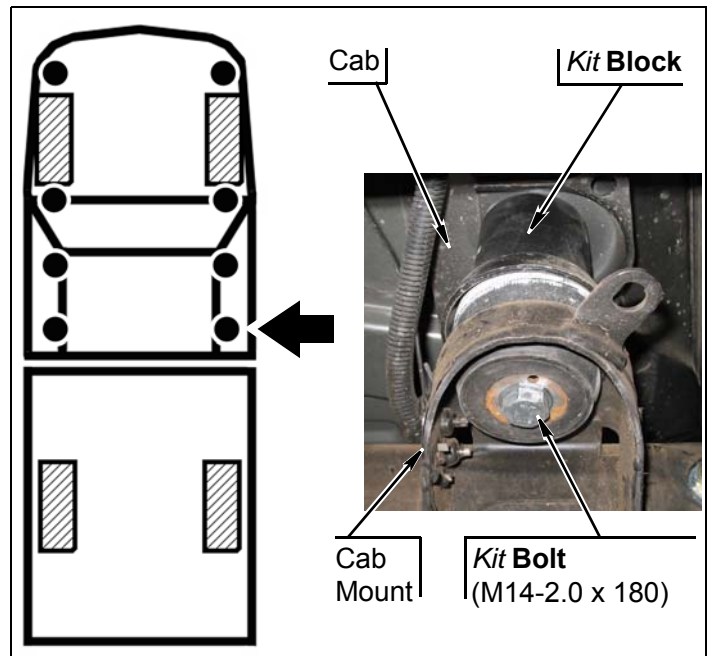

- h. Repeat previous substeps for left side of cab.
- i. Remove each **kit bolt**, one at a time, and apply a small amount of **kit Loctite®** onto threads. Install **kit bolt** and lower bushing (and O.E. nut for core support cab mount) into **kit block** and cab. **TIGHTEN kit bolts to 55 ft. lbs.**

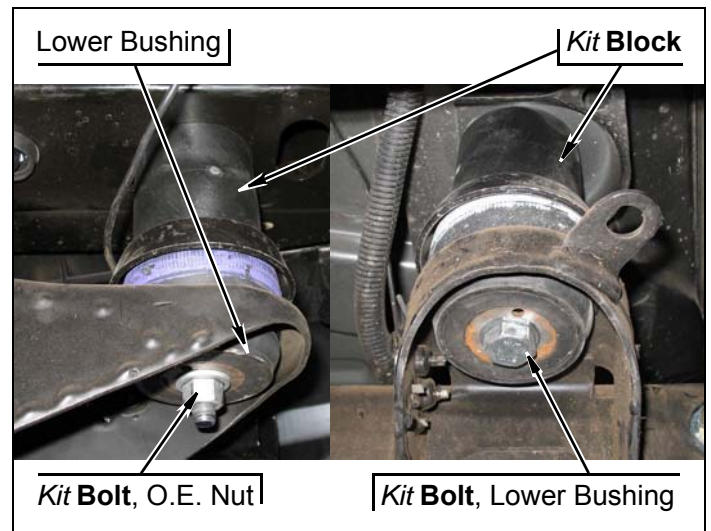

- j. Install ground straps onto front left, front right and second right body mount with bolts.

## Bed

1. Prepare to lift bed from frame



- a. Loosen, but **DO NOT REMOVE**, bed mounting bolts on left side.

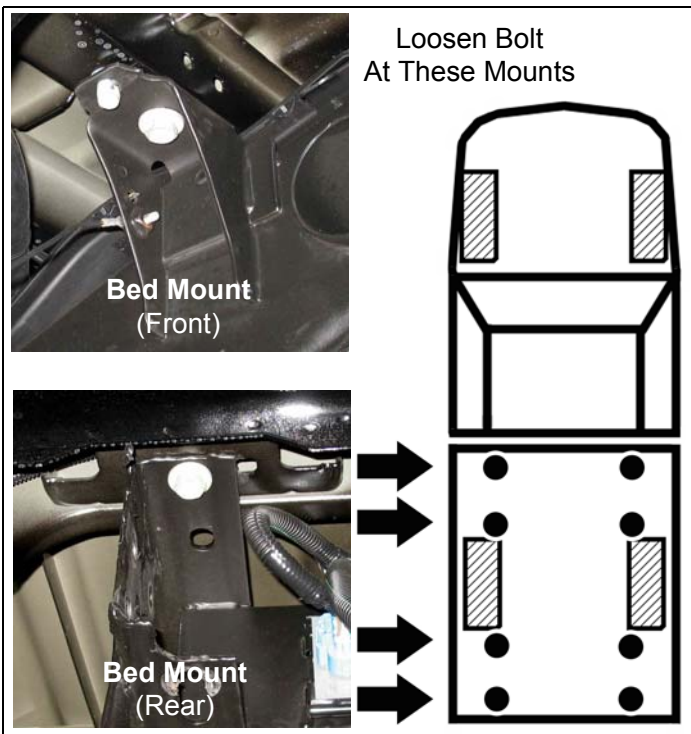

- b. Remove bed mounting bolts on right side.

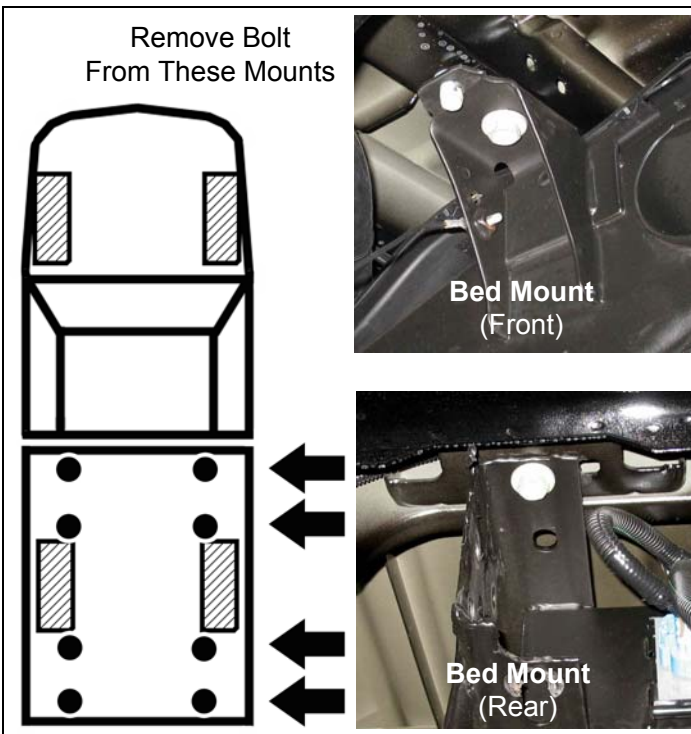

- c. Slowly lift bed just enough to install **kit block** on top of each frame mount.

**NOTE**  
The number of **kit blocks** used will vary depending on the length of the bed.

- d. Lower left side of bed and install **kit bolt** (M12-1.75 x 120) and **THICK WASHER** at each bed mount. **DO NOT TIGHTEN**.
- e. Repeat above substeps for left side of bed.
- f. Remove each **kit bolt**, one at a time, and apply a small amount of **kit Loctite®** onto threads. Install **kit bolt** and **kit washer** (M12) into **kit block** and bed. **TIGHTEN kit bolts** to **55 ft. lbs.**

## Rear of Vehicle

1. Spare tire winch

- a. Mark and cut crossmember as shown.

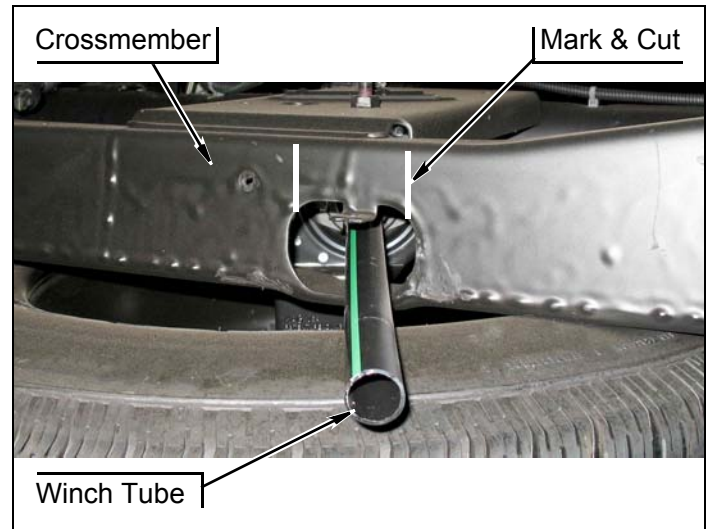

- b. Using locking pliers, pull up on cut section of crossmember to allow winch tube to angle upward.

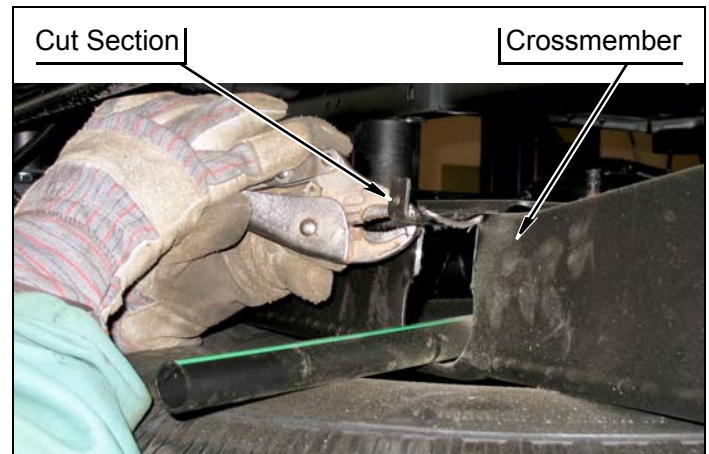

c. Using rust preventative paint, cover cut edges of crossmember.

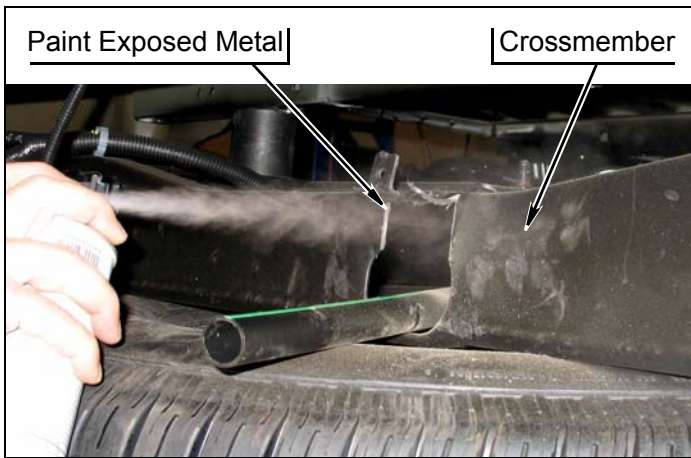

c. Remove five torx bolts from each bumper bracket and remove bumper bracket from shell.

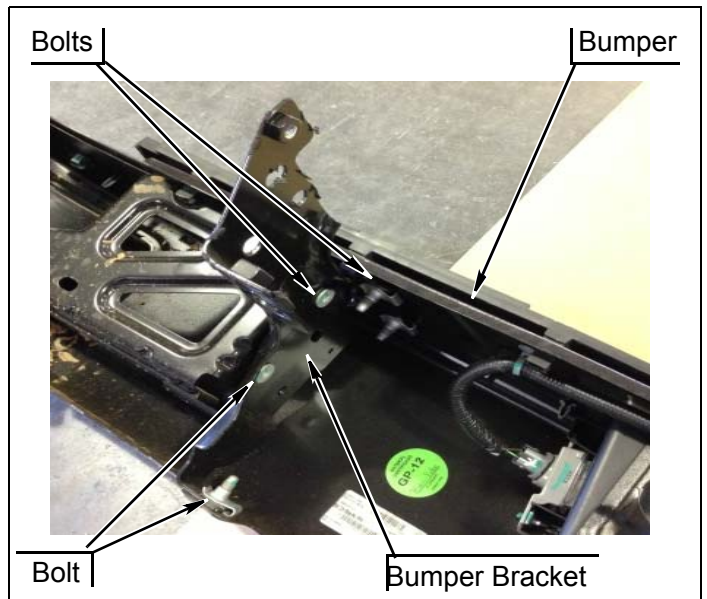

**Rear bumper**

a. Remove two clips and two screws from fascia and bumper.

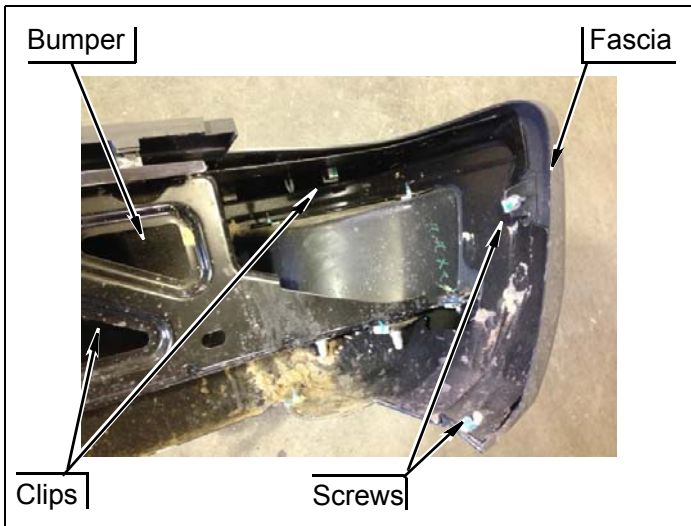

d. Remove u-nuts from OE Bumper bracket and reinstall u-nuts onto *kit* bumper brackets.

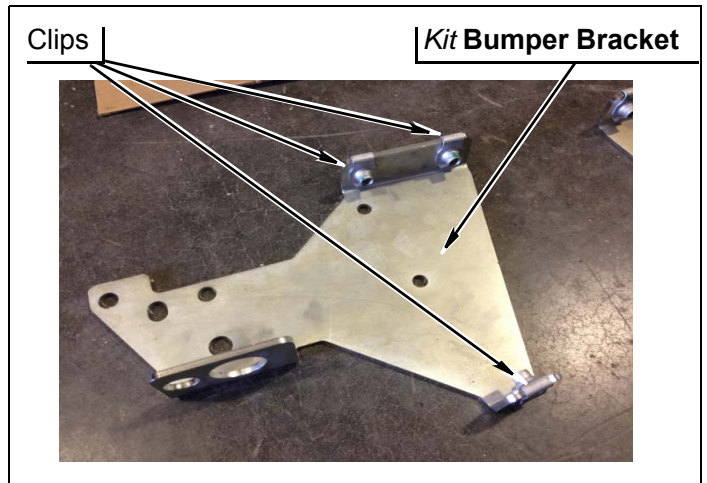

b. Remove plastic fascia from corner of bumper by gently using a pry bar to loosen each clip.

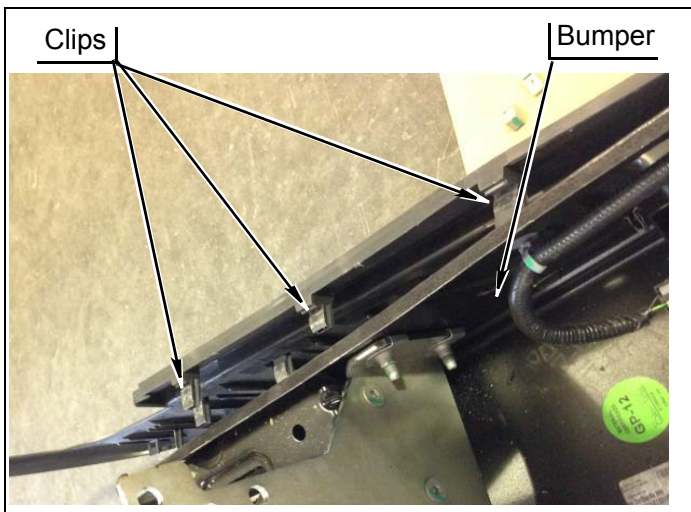

e. Position two *kit* brackets (bumper, rear) onto bumper and reinstall OE bolts.

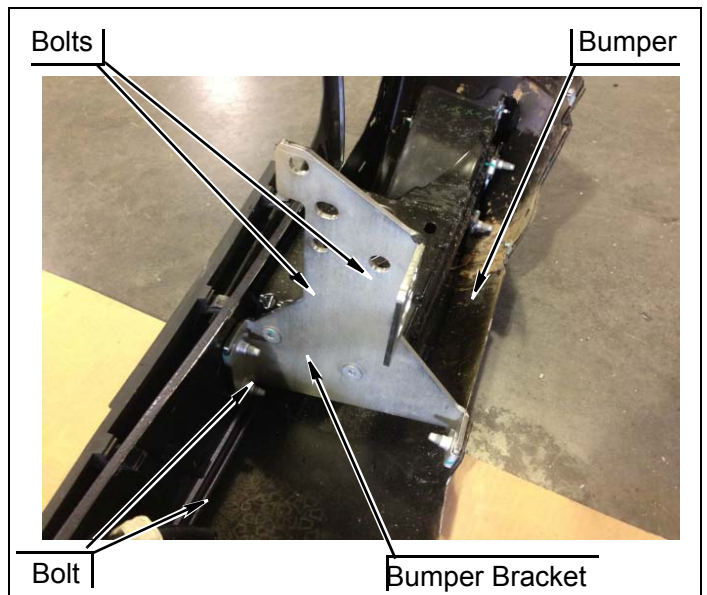



- f. **NOTE:** Use two *kit* thick washers in-between *kit* bumper bracket and bumper coner support bracket before installing both OE center bolts.

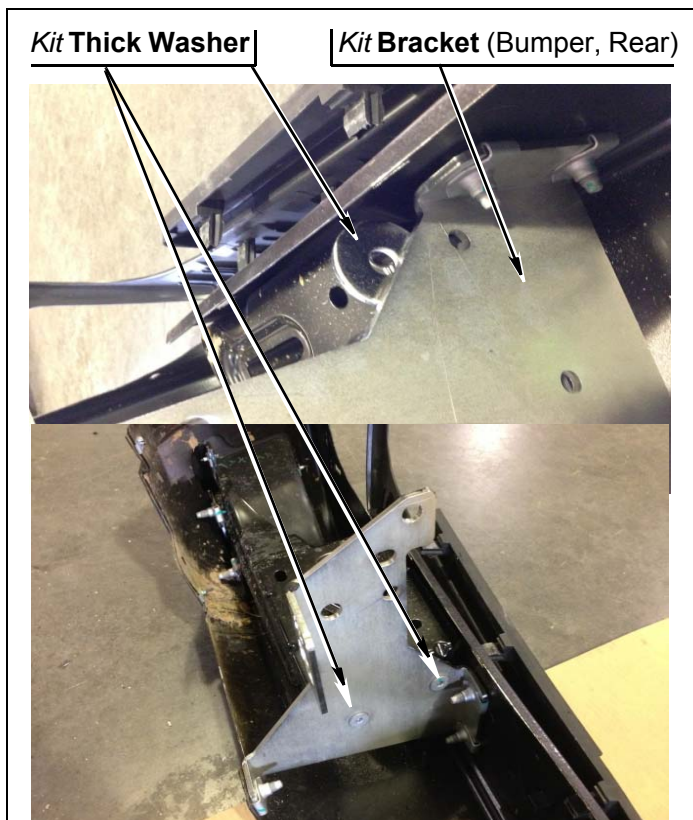

- g. Tighten all *kit* bumper bracket bolts at this time; besure both bumper brackets are square to frame rails.
- h. Reinstall corner fascia onto bumper shell with two clips and bolts in each corner.
- i. **Tow Hitch Modles:** Mark & Cut both rear hitch tabs as shown to clear new bumper location.

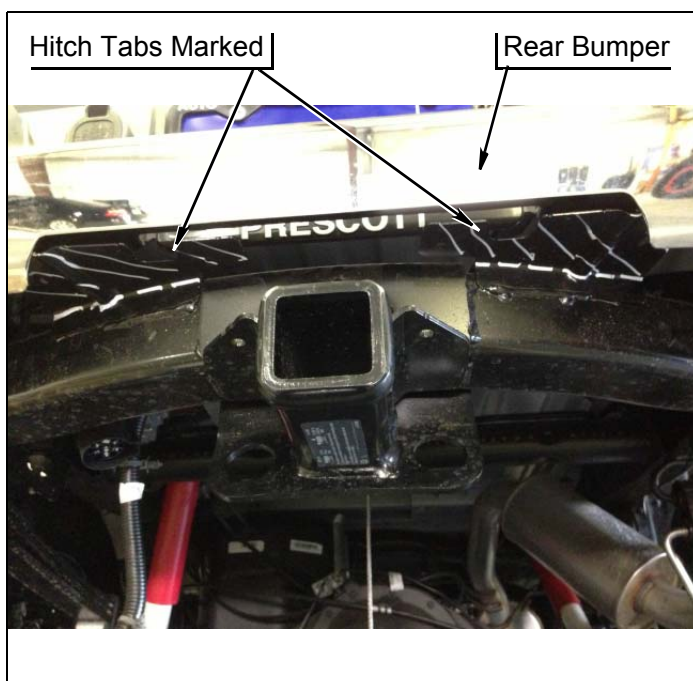

- j. Hitch Tabs Removed.

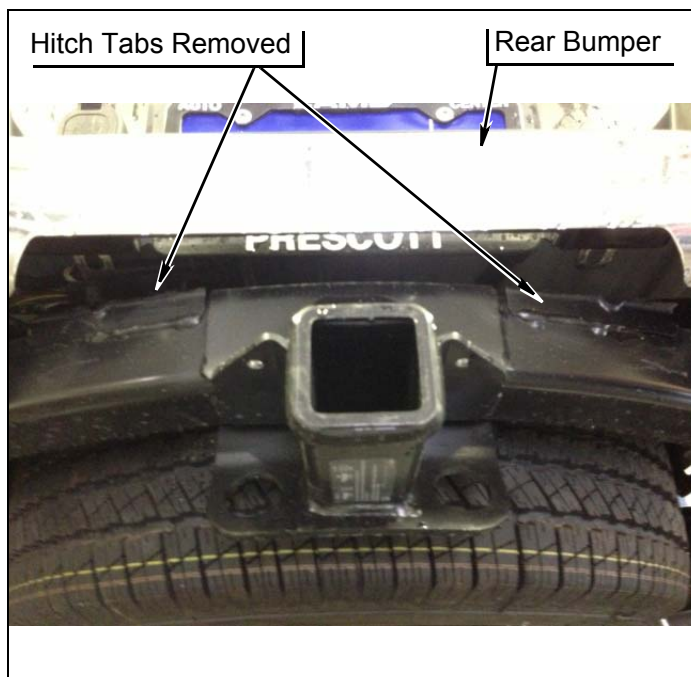

- k. Install bumper onto frame rails with two O.E. double-bolt fasteners, two nuts, two *OE* bolts (10mm) and two *kit* nuts (M10-1.5 Flange). Snug, but DO NOT TIGHTEN.

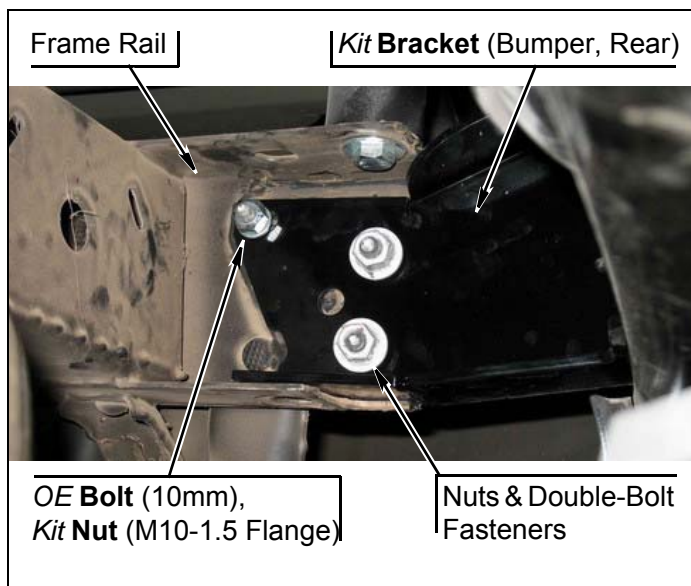

- I. Install bumper onto frame rails with two *OE bolts* (14mm), two *kit washers* (14MM) and two *kit nuts* (14mm Flange). DO NOT TIGHTEN.

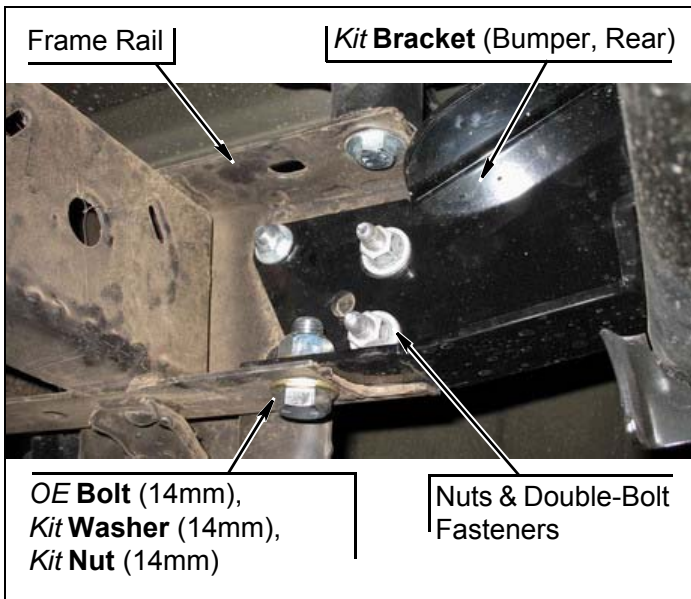

- m. Align bumper to previous measurements and TIGHTEN all bumper hardware.
- n. Connect bumper wiring harness onto cross-member.
- o. Connect trailer light harness onto bumper.
- p. Install spare tire onto vehicle according to vehicle owner's manual.

1. Install fuel filler onto bed with three O.E. bolts.

**NOTE:** You may be required to loosen filler hose clamps for proper length and adjustment to reconnect fuel filler.

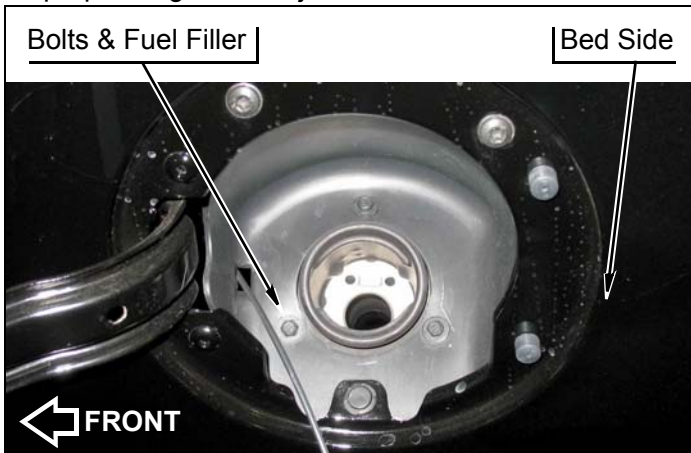

**⚠ WARNING**

Use extreme caution when working near the fuel lines and the fuel tank. Clean up spilled fuel immediately. A spark could cause an explosion or fire resulting in serious personal injury and property damage.

## Underside of Vehicle

1. Crush blocks

**NOTE**

The number of *kit blocks* (crush) used will vary depending on the length of the bed.

- a. Remove pads from two frame rails.

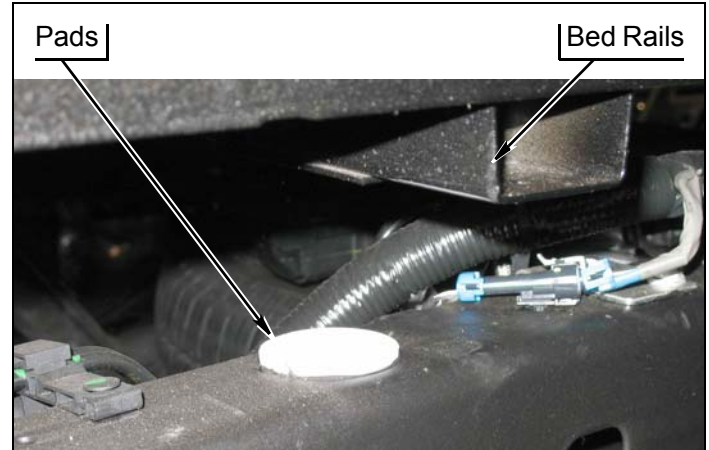

- b. Install *kit block* (crush) onto each pad location of frame with *kit bolt* (5/16"- 3/4" self-tapping) and *kit washers* (5/16").

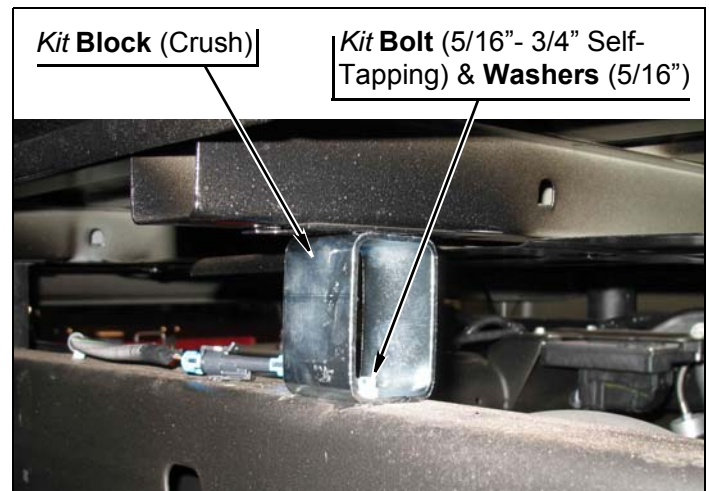

**⚠ NOTE**

The following step is for vehicles with manual transfer case only. Other models skip this step.

2. Lengthen and install transfer case shift lever.



- a. Remove two spring clips and transfer case linkage from shift lever, transfer case shift arm.

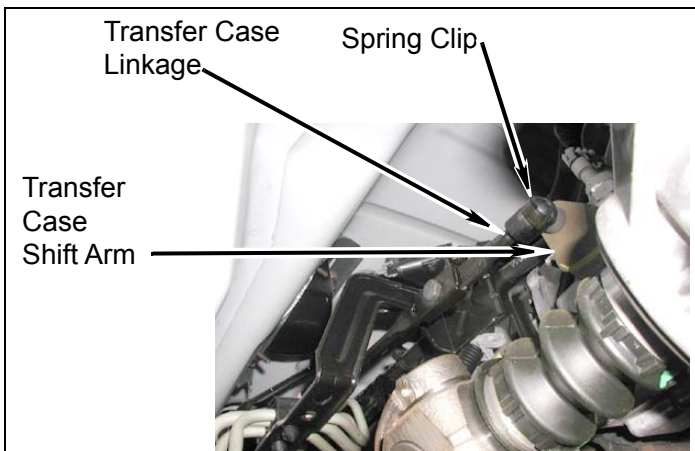

- b. Scribe a line along transfer case linkage as shown. Cut transfer case linkage into two pieces through the scribed line and deburr.

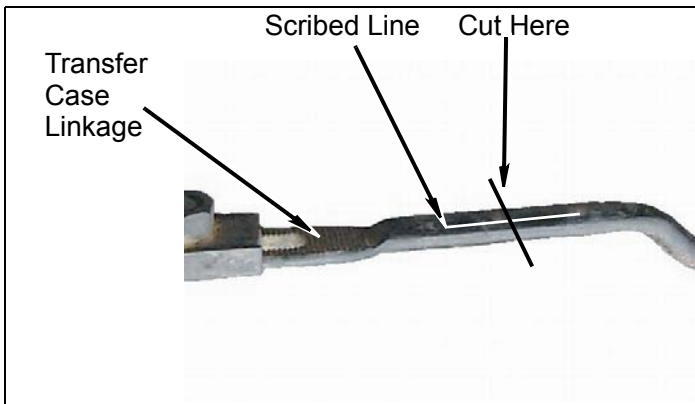

**⚠WARNING**  
A certified welder should perform all welding.

- c. Position kit **pin** 4x4 extension between two pieces of transfer case linkage. Ensure transfer case linkage scribed lines align and weld kit **pin** extension in place.

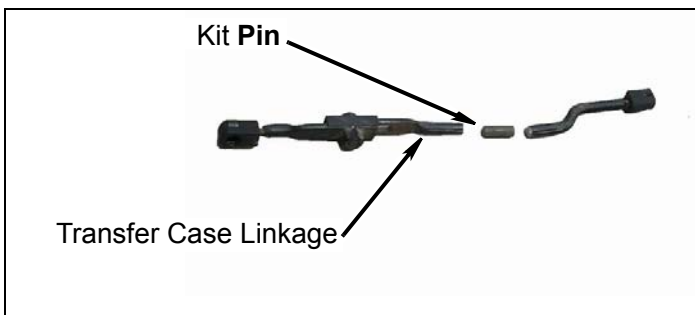

- d. Install transfer case linkage on transfer case shift arm and shift lever with two clips.
- e. Check transfer case shift lever operation. Ensure there is complete engagement in all ranges. If necessary, adjust the linkage.

### 3. Parking brake cable

- a. Install **kit bracket** (parking brake) onto second left cab mount with O.E. bolt. Mark hole with center punch.

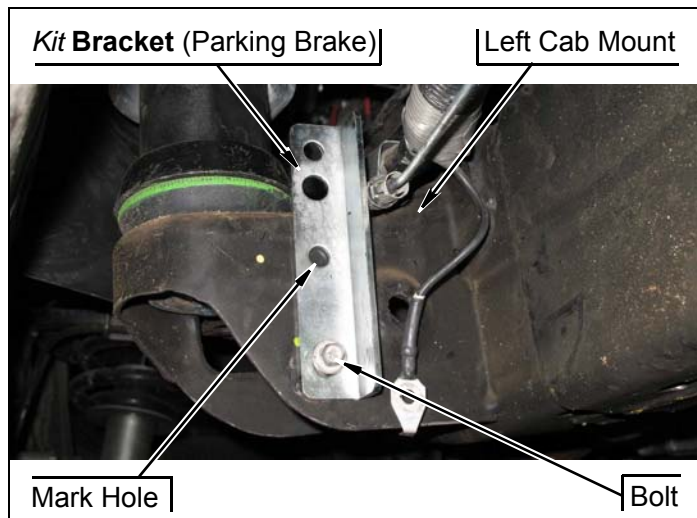

- b. Remove O.E. bolt and **kit bracket** (parking brake). Drill 3/8" hole through cab mount at marked location.

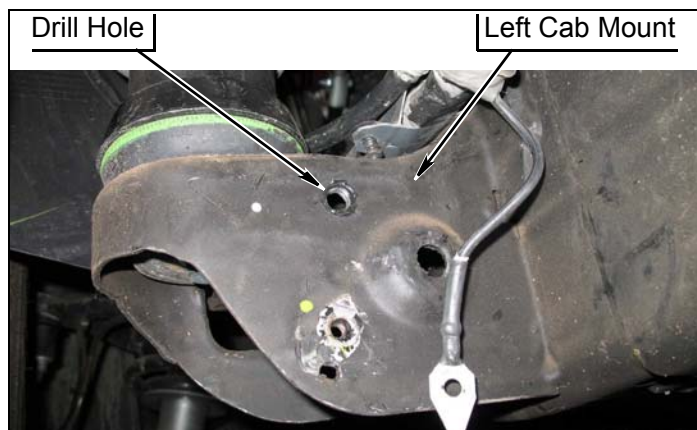

- c. Install **kit bracket** (parking brake) and ground strap onto cab mount with O.E. bolt, **kit bolt** (5/16"-18 x 1 1/4"), two **kit washers** (5/16") and **kit nut** (5/16" Nylock).

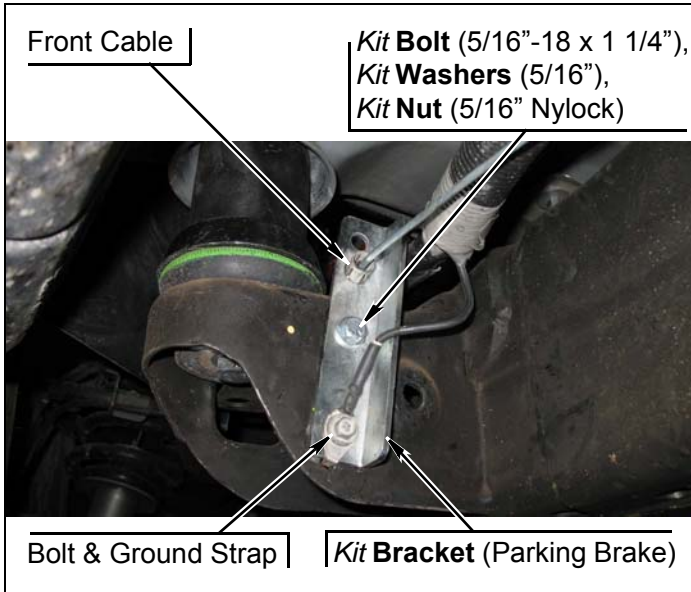

**\*\* Mid-2015+ Require New Kit Parking Cable Bracket \*\***

- d. Install **kit 2015+ bracket** (parking brake) with two **kit bolts** (5/16"-18 x 1 1/4"), four **kit washers** (5/16") and two **kit nuts** (5/16" Nylock) on top of frame body mount gusset, kit hardware will mount bracket through two existing holes on top of frame gusset.

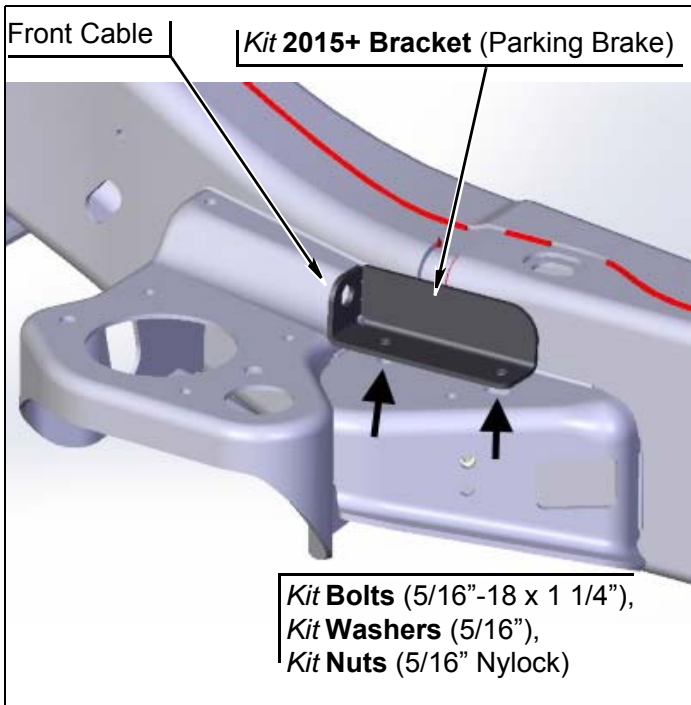

- e. Route parking brake cable through **kit bracket** (parking brake) and connect front and rear brake cables with junction.
- f. Remove locking pliers from rear cable.

- g. Install ground strap onto **kit bracket** (2" z-bent w/ stud) with **kit washer** (1/4" SAE) and **kit nut** (1/4" Nylock) onto both front frame body mounts and passenger fender well frame body mount.

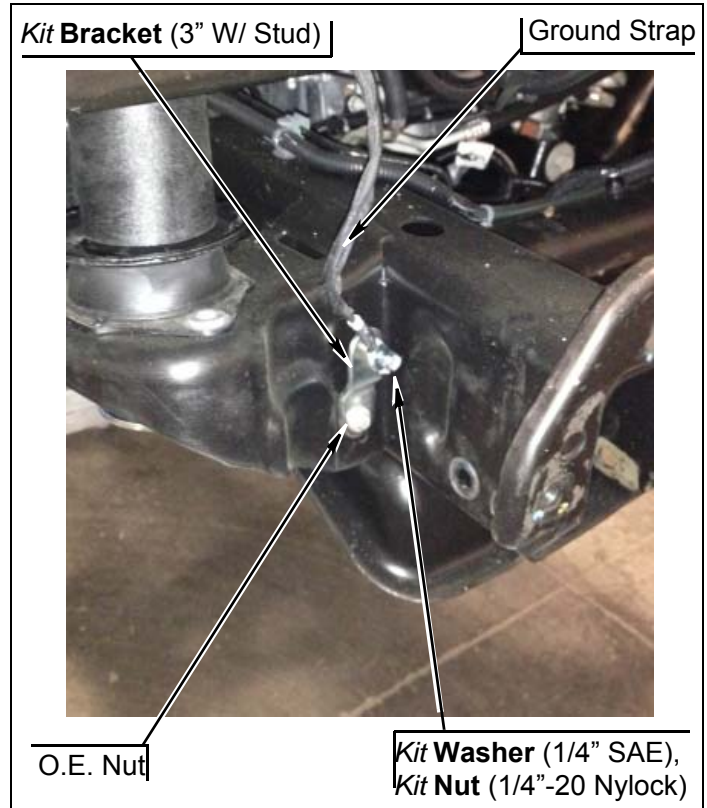

## Engine Compartment

1. Steering shaft



### ⚠ WARNING

Verify the steering extension is securely installed as specified in the instructions. Failure to do so may cause steering malfunction, resulting in property damage or serious personal injury.

- a. Install **kit extension** (steering) onto rack and pinion shaft. Ensure marks on rack and pinion shaft and upper steering shaft are aligned.



- b. Install upper steering shaft onto **kit extension** (steering), ensuring marks on upper steering shaft and lower steering shaft are aligned.
- c. Apply a small amount of **kit Loctite®** onto O.E. bolt and **kit bolt** (3/8"-24 x 1-1/4").

- 2. Install **kit bracket** (3" w/ stud) onto left firewall stud with O.E. nut.
- 3. Install ground strap onto **kit bracket** (3" w/ stud) with **kit washer** (1/4" SAE) and **kit nut** (1/4" Nylock).

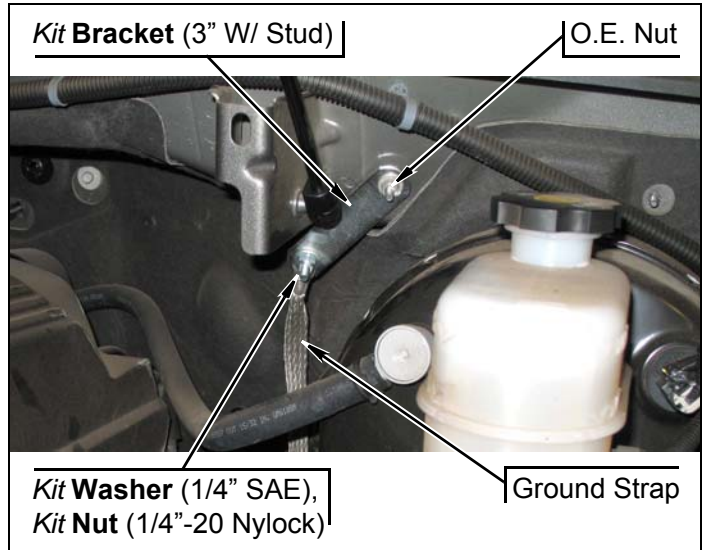
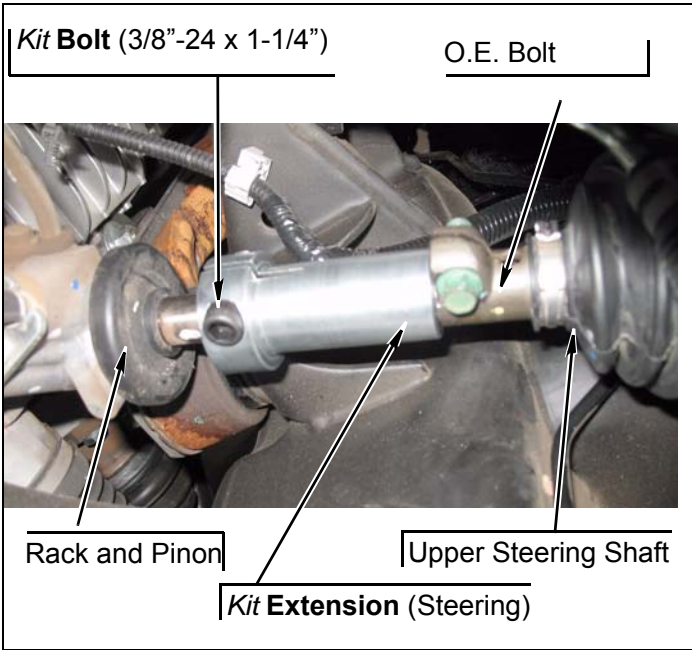

- d. Install **kit bolt** (3/8"-24 x 1-1/4") onto rack and pinion shaft and **kit extension** (steering).
- e. Install O.E. bolt onto upper steering shaft and **kit extension** (steering).
- f. TIGHTEN bolts to **33 lb.-ft.**

- 4. Install harness and metal clip onto right frame rail with bolt.
- 5. Electric Fan Shroud Modification

- a. Carefully **Mark, Cut & Remove** both inner verticle fan shroud support ribs as shown below:

**NOTE:** Doing so will allow the factory air intake housing to properly reinstall onto throttle body. If the vehicle has an aftermarket intake hose, this step may be dismissed.

**NOTE**  
It may be necessary to bend the power steering line slightly away from the steering shaft and boot in next step.

- g. Rotate power steering hose pinch clamp down and away from steering boot.

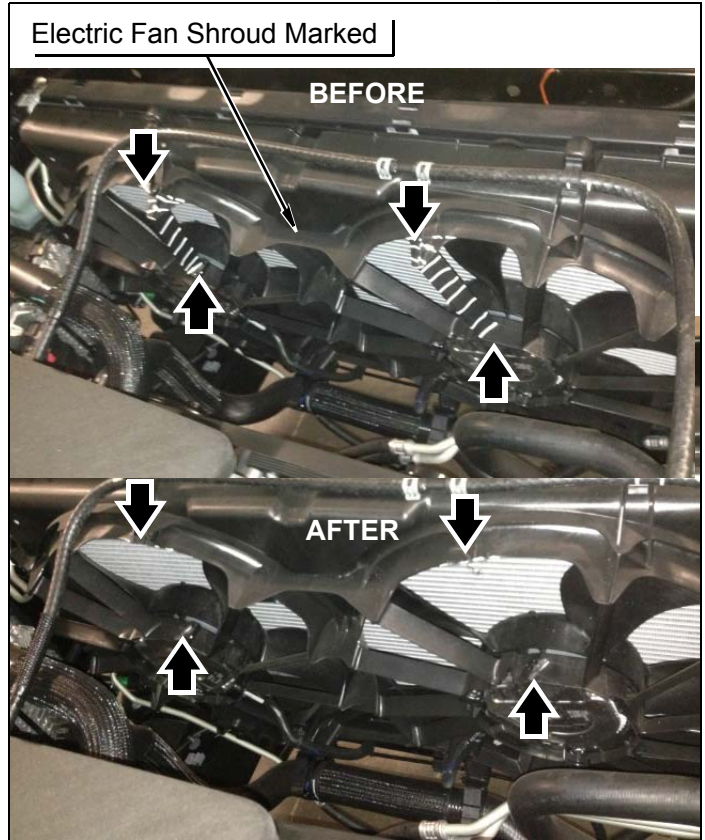
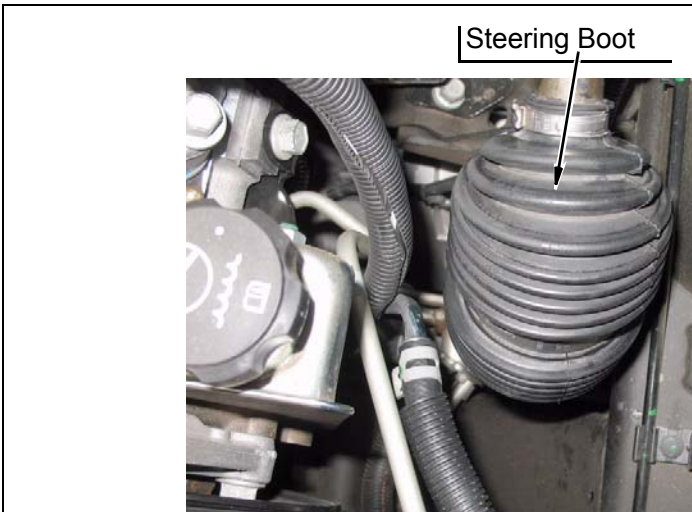

6. Air Intake

- a. Reinstall air intake hose onto throttle body and air box port.

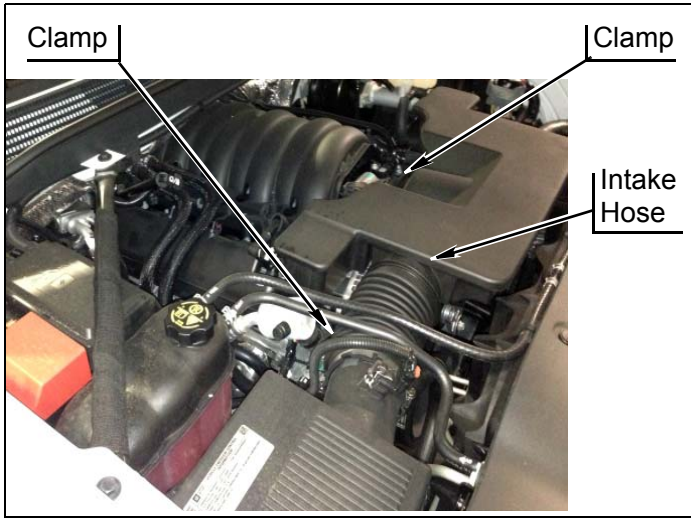

Front of Vehicle

- 1. Pull slack into lines for transmission cooler to make sure they have adequate clearance everywhere needed.
  - a. Install lower guard to core support and frame with factory bolts.

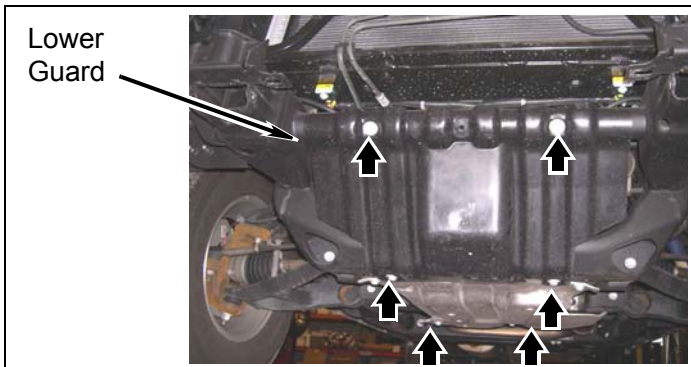

2. Front Tow Hooks

- a. Carefully **Mark & Drill** each tow hook hole with a 1/2" drill bit **3"** higher than the original location to relocate OE tow hooks.

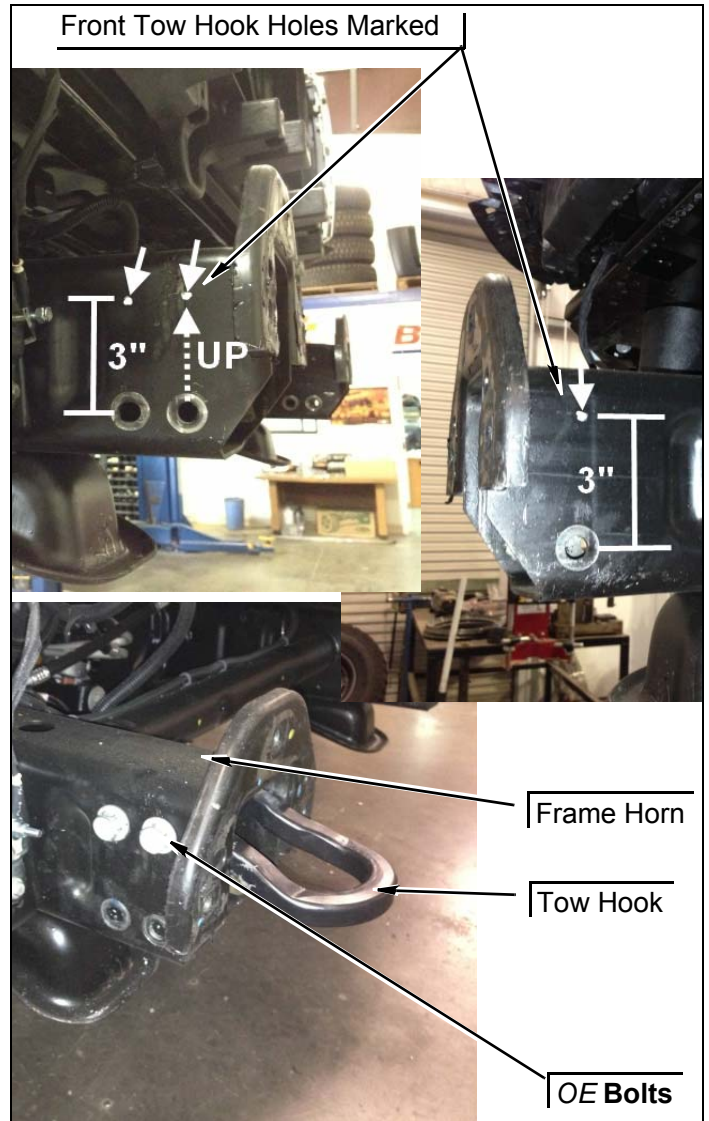

3. Front bumper



- a. Install **kit bracket** (bumper, front, left) and **kit bracket** (bumper, front, right) onto left frame horn with six **OE bolts**. Align and **TIGHTEN**.

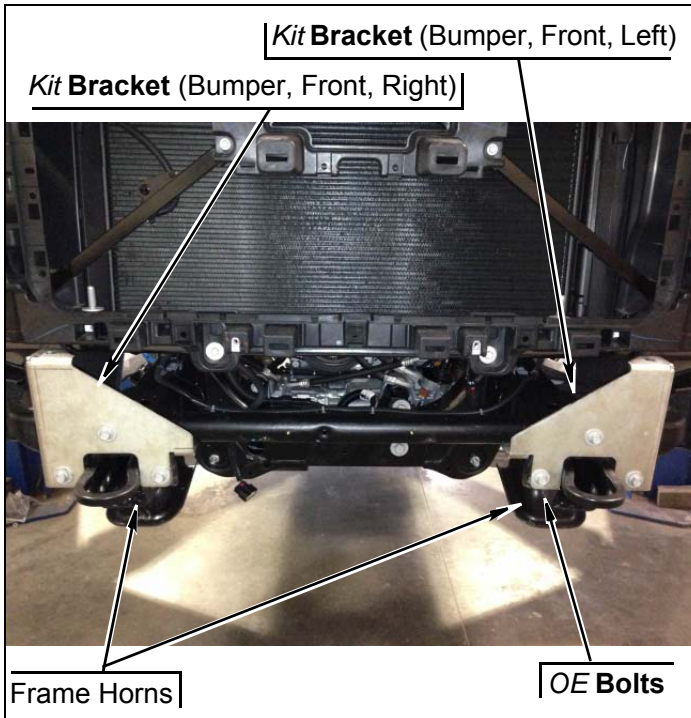

- b. Assemble both kit inner front bumper brackets using four **kit bolts** (3/8" x 1"), eight **kit washers** (3/8" SAE) and four **kit nuts** (3/8" Nylock).

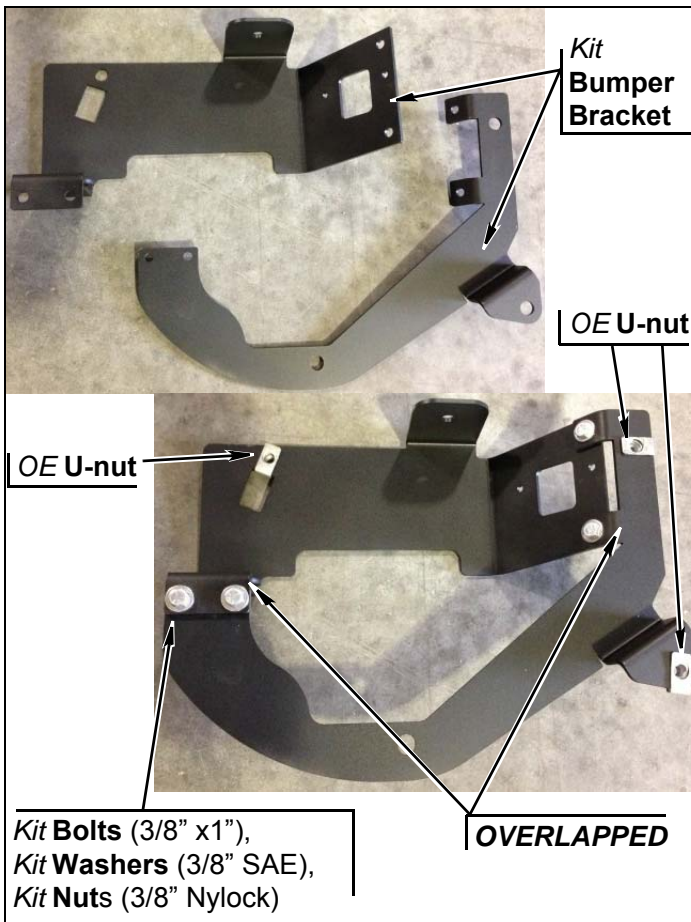

- c. Disconnect OE foglight harness.

- d. Remove both front bumper brackets by removing all eight bolts and OE u-nuts from brackets.

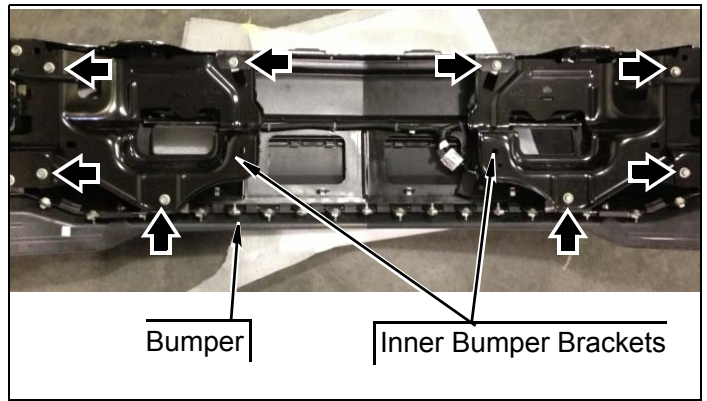

- e. Carefully **Mark, Cut & Remove** a small section of the front bumper fascia where the tow hooks come through the bumper as shown below:

**NOTE:** This step will allow the bumper to move up 3" properly without interfering with the lower frame horns.

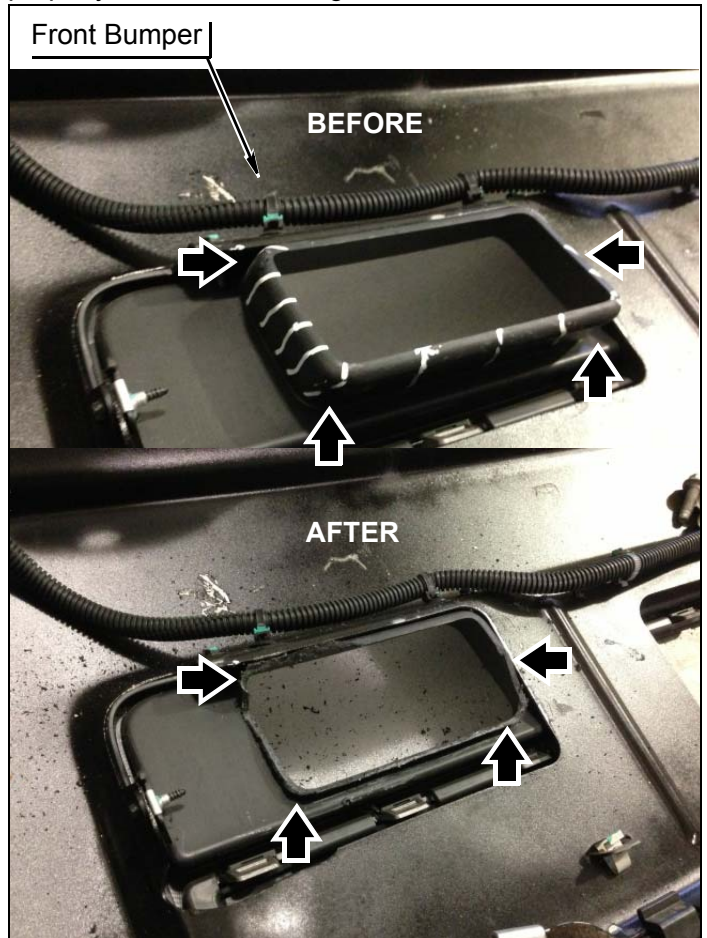



- f. Install both *kit inner bumper bracket assemblies* into stock locations, inside bumper shell, with eight OE bolts as shown below:

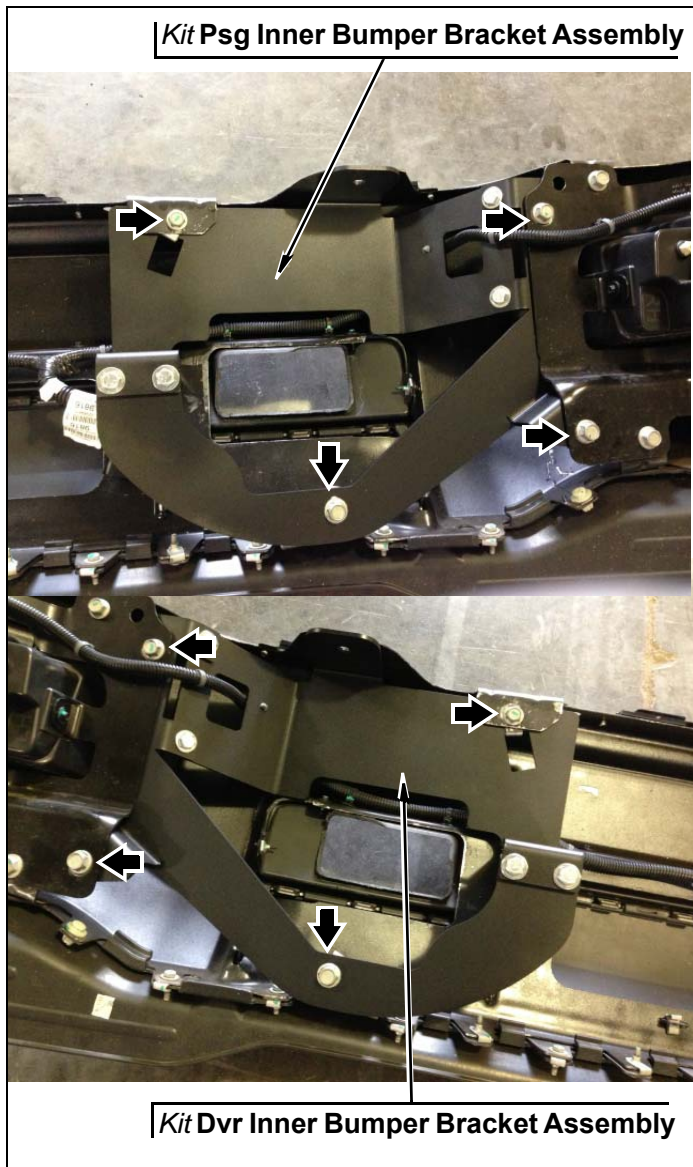

- g. Reconnect foglight wiring harnesses.

- h. Install bumper onto frame brackets with four O.E. bolts, four *kit washers*(12mm) and four *kit nuts*(12mm). DO NOT TIGHTEN.



- i. Install each bumper side support onto frame using two OE bolts. DO NOT TIGHTEN.
- j. Install each bumper side support onto bumper with one *kit spacer* (bumper, front, support) with one *kit bolts* (10mm) & one *kit washer* (10mm) in-between side support and bumper as shown below: DO NOT TIGHTEN.

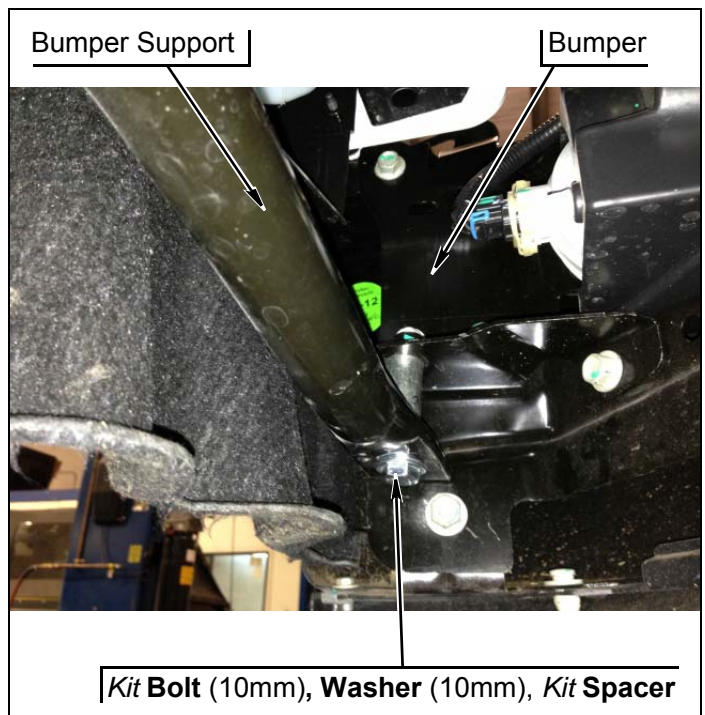

- k. Align bumper to previous measurements and TIGHTEN all bumper hardware.



l. Reconnect fog lamp connector and attach onto bumper, if equipped.

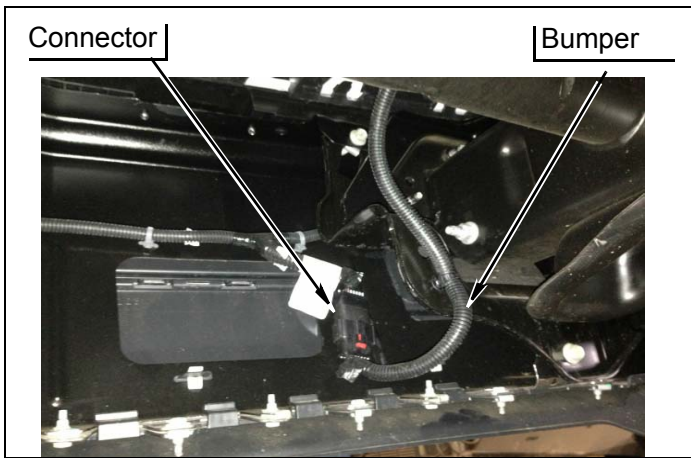

o. Reinstall two bolts into side fascia inside inner fender wells with a 7mm socket.

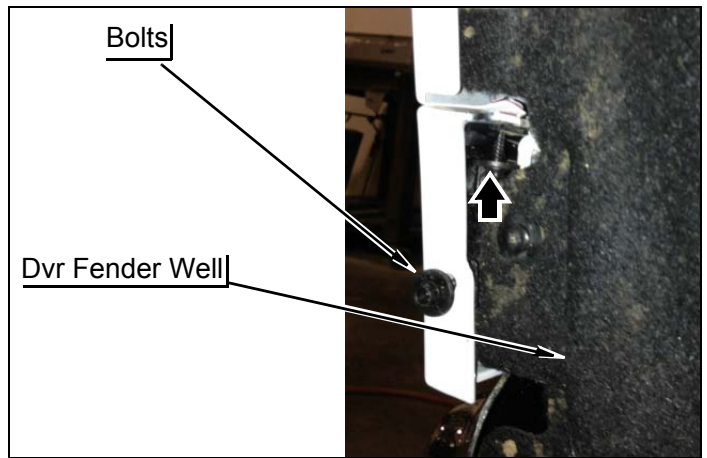

m. Reinstall grille by inserting lower grille clips into lower core support and install four screws into upper grille on core support.

n. Reinstall front air shield along with clips .

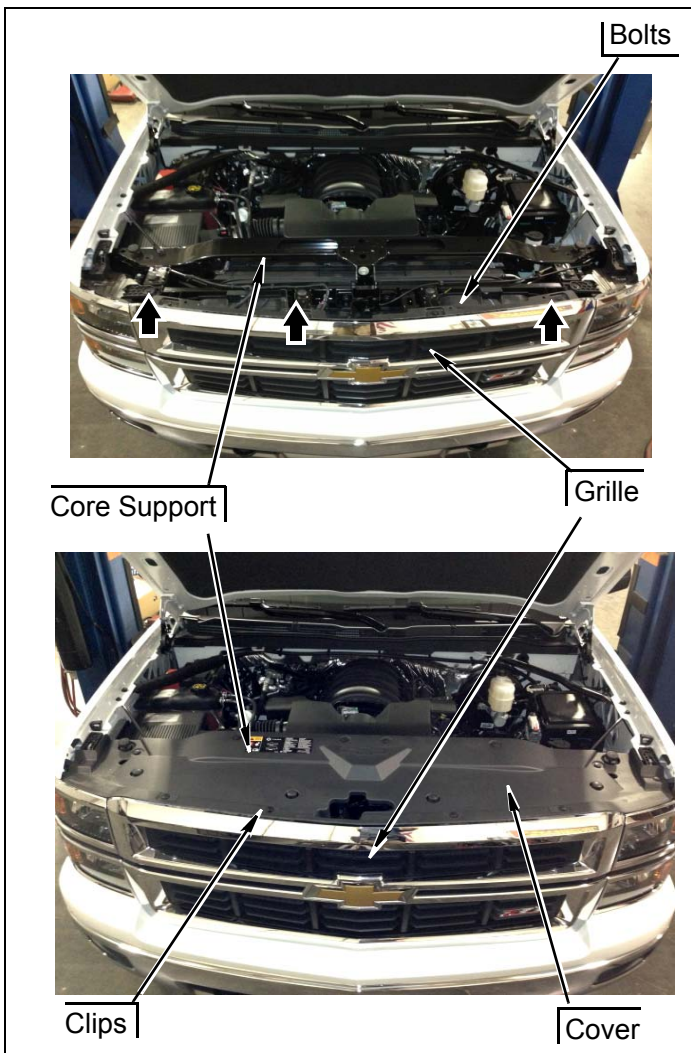

p. Reinstall four bolts into lower grille fascia with a 10mm socket on back-inside of lower grille.

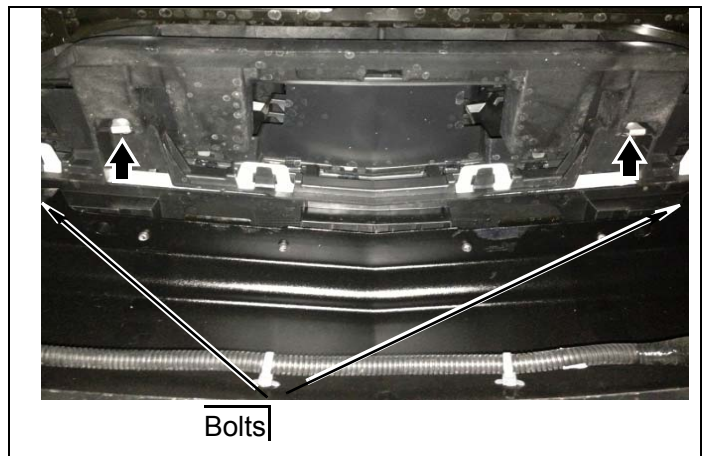

# After Completing Installation

## Engine Compartment

1. Connect both battery cables. Connect positive cable first, then negative cable.
2. Install airbag fuse and fuse block cover.

## Miscellaneous

1. Apply *kit label* (warning) onto dashboard in plain sight of all vehicle occupants.
2. Check all fasteners to ensure they are tight.
3. Ensure all wires, hoses, cables, etc. are properly connected and there is ample slack.
4. Adjust headlights.

## Dynamic Vehicle Check

1. Check steering in both directions to ensure that there is no bind. Check operation of clutch, brake system, and parking brake. Check operation of transmission and transfer case. Ensure there is full engagement in all gears and 4WD ranges. Check battery connections and electrical component operations. Test-drive vehicle. Accessories

### ⚠ WARNING

Retorque all fasteners after 500 miles and after off road use. All body lift components should be visually inspected and fasteners retorqued during routine vehicle servicing.

### ⚠ CAUTION

Performance Automotive Group does not recommend any particular wheel and tire combinations for use with its body lifts and cannot assume responsibility for the customer's choice of wheels and tires. Refer to your owner's manual for recommended tire sizes and warnings related to the use of oversized tires. Larger wheel and tire combinations increase stress and wear on steering and suspension components, which leads to increased maintenance and higher risk for component failure. Larger wheel and tire combinations also alter speedometer calibration, braking effectiveness, center of gravity, and handling characteristics. Consult an experienced local off road shop to find what wheel and tire combinations work best with your vehicle.

### NOTE

All warranty information, instruction sheets, and other documents regarding the installation of this product must be retained by the vehicle owner. Information contained in the instructions and on the warranty card will be required for any warranty claims. The vehicle owner needs to understand the modifications made to the vehicle and how they affect vehicle handling and performance. Failure to provide the customer with this information can result in damage to the vehicle and severe personal injury.

## Kit# 6547 Gap Guards





# KIT PARTS LIST

## Qty. Description

14	<b>Block</b>
2	<b>Block (mini)</b>
4	<b>Block (crush)</b>
1	<b>Bracket (frame, front, dvr)</b>
1	<b>Bracket (frame, front, psg)</b>
2	<b>Bracket (bumper, front, dvr)</b>
2	<b>Bracket (bumper, front, psg)</b>
1	<b>Bracket (bumper, rear, dvr)</b>
1	<b>Bracket (bumper, rear, psg)</b>
1	<b>Label (logo)</b>
1	<b>Label (warning)</b>
1	<b>Loctite® (6ml bottle)</b>
<b>1</b>	<b>BP10293 (Bolt pack)</b>
8	<b>Bolt (M12-1.75 x 120)</b>
2	<b>Bolt (M12-1.75 x 200)</b>
2	<b>Bolt (M14-2.0 x 180)</b>
4	<b>Bolt (M14-2.0 x 210)</b>
1	<b>Bolt (3/8"-24 x 1-1/4")</b>
1	<b>Bracket (parking brake)</b>
1	<b>Bracket (2015+ parking brake)</b>
1	<b>Extension (steering)</b>
20	<b>Washer (7/16")</b>
14	<b>Washer (Thick)</b>
<b>1</b>	<b>HP10293 (Hardware pack)</b>
2	<b>Bolt (M10-1.5 x 80)</b>
2	<b>Bolt (5/16" x 1 1/4")</b>
8	<b>Bolt (3/8" x 1")</b>
4	<b>Bolt (5/16"-18 x 3/4" self-tapping)</b>
3	<b>Bracket (2" "Z"-bend with stud)</b>
1	<b>Bracket (3" with stud)</b>
4	<b>Nut (1/4"-20 Nylock)</b>
2	<b>Nut (5/16" Nylock)</b>
8	<b>Nut (3/8" Nylock)</b>
2	<b>Nut (10mm Flange)</b>
4	<b>Nut (12mm Flange)</b>
2	<b>Nut (14mm Flange)</b>
2	<b>Spacer (bumper support)</b>
1	<b>Pin, 4x4 extension, 1/2" X 1"</b>
16	<b>Washer (3/8" SAE)</b>
8	<b>Washer (5/16" USS)</b>
4	<b>Washer (1/4" SAE)</b>
2	<b>Washer (10mm)</b>
2	<b>Washer (14mm)</b>