



841 S. 71st Avenue • Phoenix, AZ 85043
(623) 907-0081
www.performanceaccessories.com

NISSAN FRONTIER CREW CAB 2 & 4WD 3" BODY LIFT KIT INSTALLATION INSTRUCTIONS 2001-2004 KIT# PA40043

⚠ WARNING

This kit should only be installed on a vehicle that is in good working condition. Before you install the kit, thoroughly inspect the vehicle for corrosion or deformation of the sheet metal around the factory body mounts. If the vehicle is suspected to have been in a collision or misused, do not install this kit. Off-road use of your vehicle with this kit installed may increase the stress applied to the factory body mounts. We do not recommend that any vehicle with a body lift kit installed be involved in any extreme off-road maneuvers such as jumping. Failure to observe this warning may result in serious personal injury and/or severe damage to your vehicle.

⚠ WARNING

Many states and municipalities have laws restricting bumper heights and vehicle lifts. Consult state and local laws to determine if the changes you intend to make to the vehicle comply with the law.

⚠ WARNING

The installation of larger tires may reduce the effectiveness of the braking system.

⚠ WARNING

Always wear eye protection when operating power tools.

⚠ WARNING

Before you install this kit, block the vehicle tires to prevent the vehicle from rolling.

⚠ WARNING

Accidental deployment of the air bag can result in serious personal injury or death. To avoid accidental deployment during installation of the kit, the Supplemental Restraint System (SRS, or airbag) must remain deactivated. Do not allow anyone near the airbag during installation. Refer to the factory service manual or owner's manual for the recommended procedure to disable the SRS. After you install the kit, reactivate the SRS before driving the vehicle.

NOTE

Performance Accessories recommends using the Loctite® supplied in the kit on the threads of all kit nuts and bolts unless specified otherwise in these instructions.

⚠ WARNING

Installation of a Performance Accessories body lift kit will change the vehicle's center of gravity and handling characteristics both on- and off-road. You must drive the vehicle safely! Extreme care must be taken to prevent vehicle rollover or loss of control, which could result in serious injury or death. Avoid sudden sharp turns or abrupt maneuvers and always make sure all vehicle occupants have their seat belts fastened.

⚠ WARNING

Before you install this kit, read and understand all instructions, warnings, cautions, and notes in this instruction sheet and in the vehicle owner's manual.

⚠ CAUTION

Proper installation of this kit requires knowledge of the factory recommended procedures for removal and installation of original equipment components. We recommend that the factory shop manual and any special tools needed to service your vehicle be on hand during the installation. Installation of this kit without proper knowledge of the factory recommended procedures may affect the performance of these components and the safety of the vehicle. We strongly recommend that a certified mechanic familiar with the installation of similar components install this kit.

⚠ WARNING

DO NOT combine suspension, body, or other lift devices. Use of vehicle with combined lifts may result in unsafe and/or unexpected handling characteristics.

A. Before you start.

⚠NOTE

As you read through this procedure, note that each part referenced has the same callout number throughout. Also, the part number in the text matches the corresponding part number in the art. *kit* parts are prefaced by the word *kit* in italics.

⚠NOTE

You will find it easier to keep track of hardware if immediately after removal you put the fasteners for each subassembly in a paper lunch bag and write on the bag where they go.

1. Read all warnings and instructions completely and carefully before you begin.
2. Check to make sure the *kit* is complete (refer to the Parts List, section E).
3. Only install this *kit* on the vehicle for which it is intended. If anytime during the installation you encounter something different from what is outlined in the instructions, call technical support at (928) 636-0979.
4. Park the vehicle on a clean, dry, flat, level surface and block the tires so the vehicle cannot roll in either direction.
5. Disconnect both battery cables. Disconnect the negative cable (1) first, then the positive cable (2) from the battery (3).

⚠NOTE

Fuse locations may vary. Check fuse chart in owners manual.

6. Remove cover (4) and airbag fuse (5) from fuse panel (6). See owners manual for fuse location.

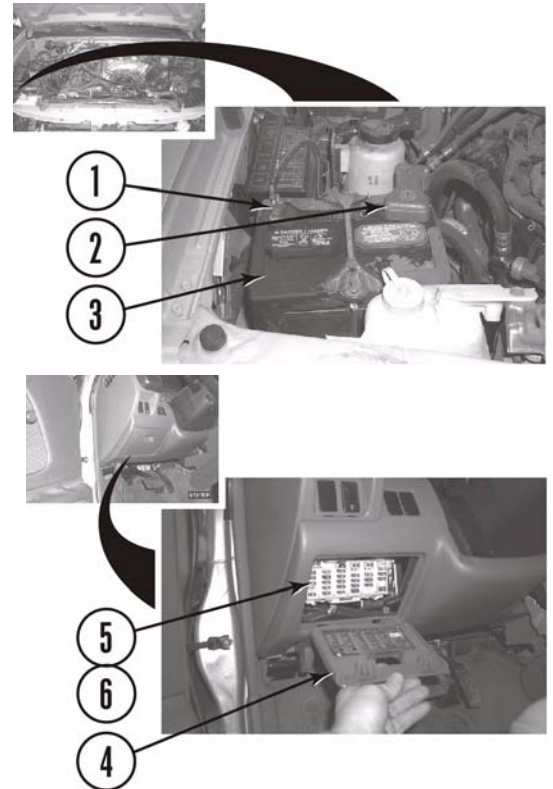

B. Get ready to install the kit.

1. Front bumper.

- a. Remove two wiring harness connectors (7) from running lights (8).

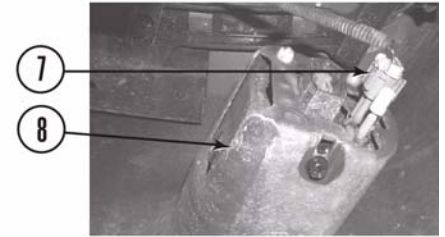

- b. Remove two screws (9) from front outer bumper (10) and upper crush zone (11).

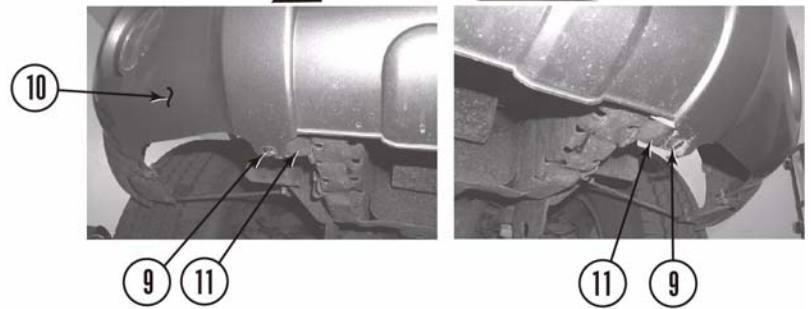

- c. Remove six plastic bolts (12) and push clips (13) from front outer bumper (10) and core support (14).

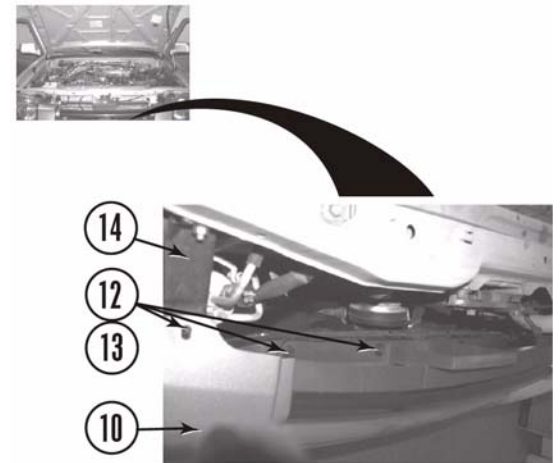

- d. Remove two bolts (15) and two screws (16) from front outer bumper (10) and front fenders (17).

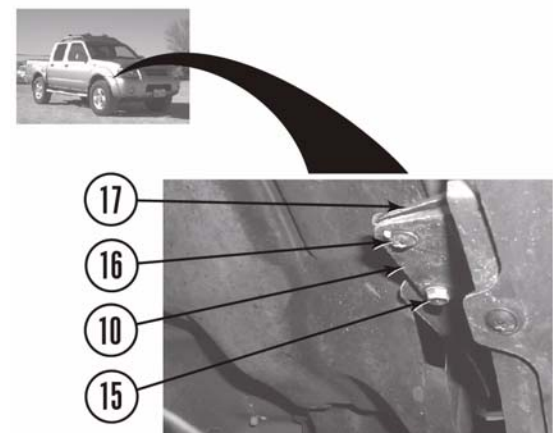

- e. Remove two bolts (18) and front outer bumper (10) from two side front outer bumper braces (19).

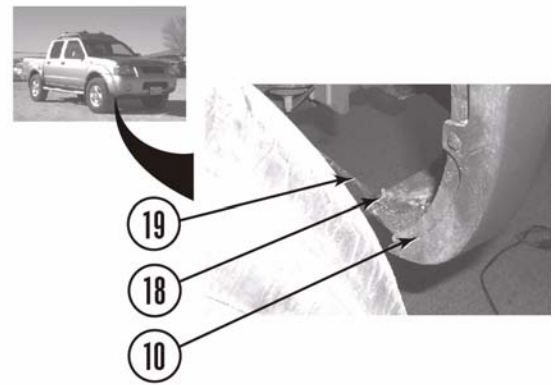

- f. Remove front outer bumper (10) from core support (14), frame (20).

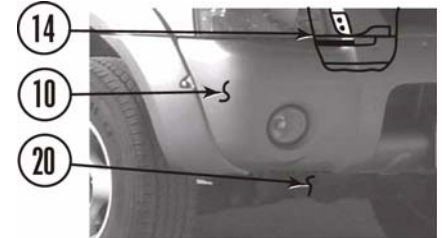

- g. Remove six bolts (21), lower crush zone (22) and upper crush zone (11) from frame (20).

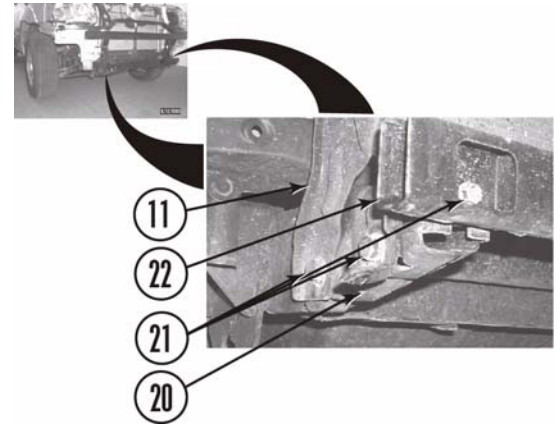

2. Air filter housing.

- a. Cut zip tie (23) from wiring harness (24) and air intake (25).
- b. Remove wiring harness connector (24) from air cleaner housing top (26).
- c. Remove two clamps (27 and 28) from air intake (25) and air cleaner housing top (26) and air box (29).
- d. Remove four air cleaner clamps (30) and air cleaner housing top (26) from air filter (31), lower air cleaner housing (32), and vehicle.

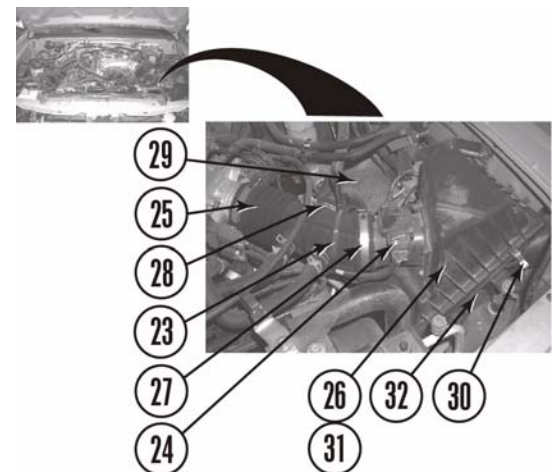

3. Radiator.

- a. Remove six push clips (33) from front air flap (34) and core support (14).

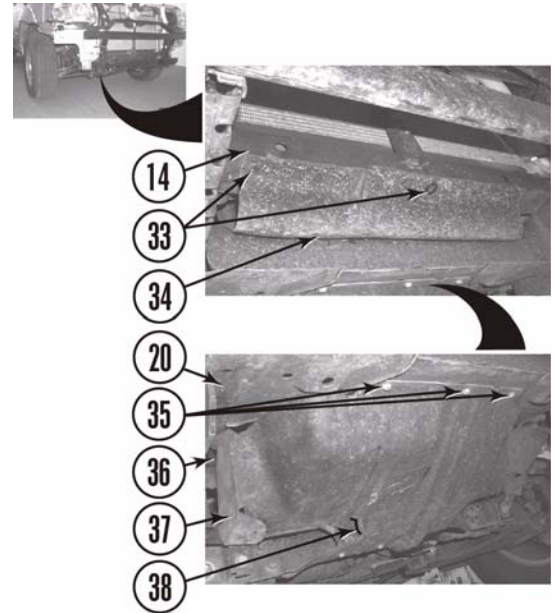

- b. If so equipped, remove six bolts (35), two large push clips (36), two skid plate wings (37), and skid plate (38) from frame (20) and vehicle.

- c. Remove clamp (39) and overflow hose (40) from overflow bottle (41).

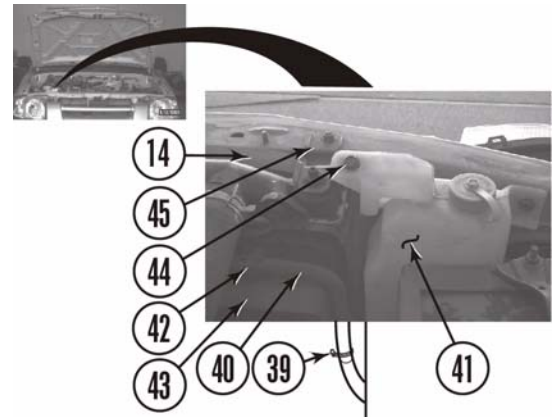

- d. Remove overflow hose (40) from two clamps (42) and fan shroud (43).

- e. Remove two bolts with captive washers (44) and overflow bottle (41) from bracket (45) and core support (14).

- f. Remove two bolts (46) from fan shroud (43) and radiator (47).

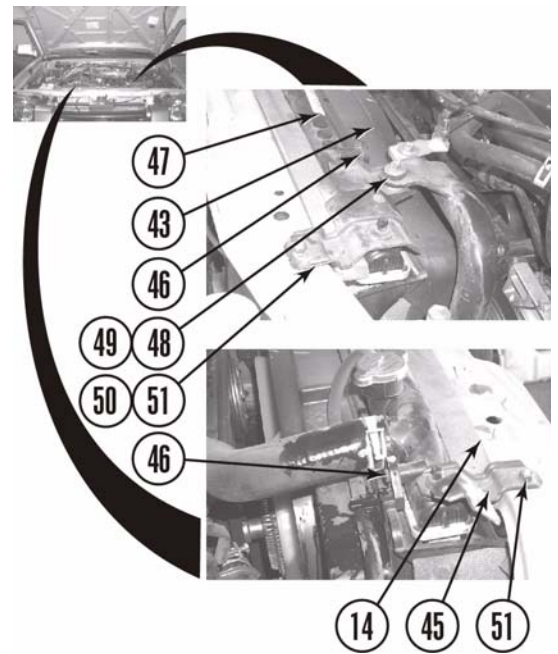

- g. Remove bolt with captive washer (48) from air tube (49) and bracket (50).

- h. Remove two nuts (51) and two brackets (45 and 50) from core support (14) and radiator (47).

⚠WARNING

Ensure radiator has cooled enough to safely open cooling system.

- i. Remove radiator drain plug (52) and completely drain radiator (47) into a clean container (refer to the owner's manual). Install radiator drain plug in radiator.

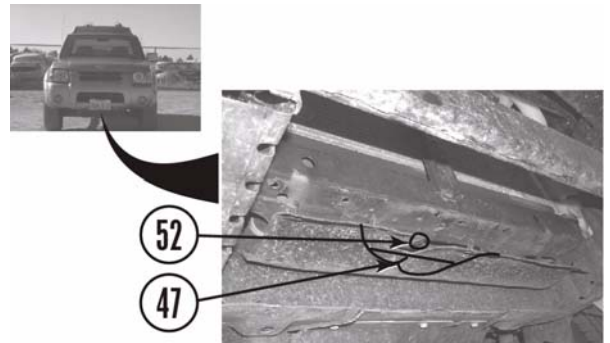

- j. Remove clamp (53) and upper radiator hose (54) from radiator (47).

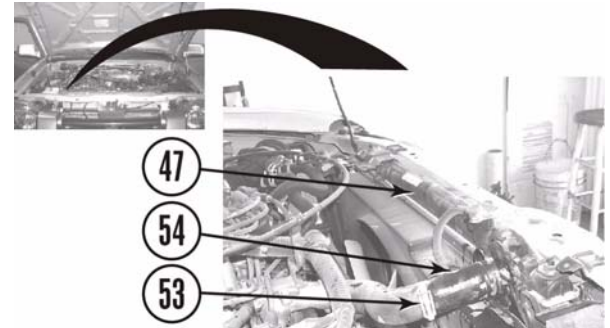

- k. Remove lower fan shroud cover (55) from fan shroud (43).

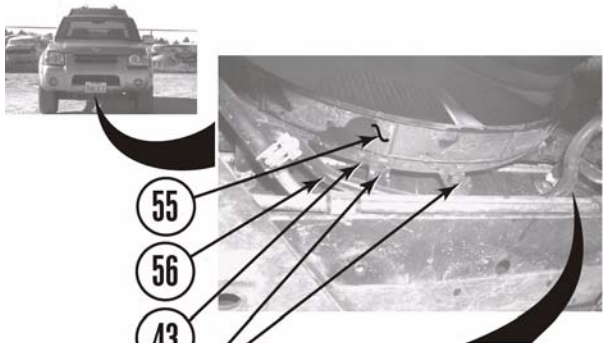

- l. Remove transmission cooler hose (56) from two clips (57) and fan shroud (43).

- m. Remove fan shroud (43) from vehicle.

- n. Remove clamp (53) and lower radiator hose (58) from radiator (47).

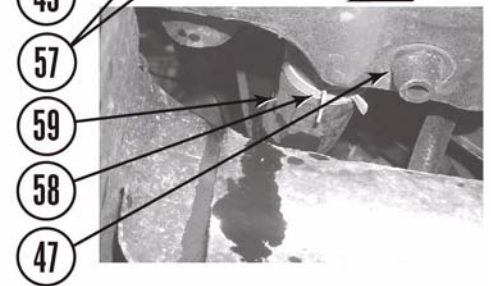

- o. Remove two hose clamps (59) and transmission cooler hoses (56 and 60) from lower radiator (47). Plug transmission cooler hoses.

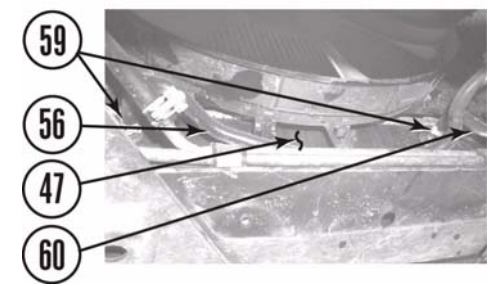

- p. Carefully remove radiator (47) from vehicle.

4. Steering shaft.

NOTE

Ensure steering shaft does not turn independently of the steering gearbox. This could cause the air bag system to malfunction, resulting in serious personal injury or damage to the equipment.

- a. Remove two gap guards (61 and 62) and nine push clips (63) from inner fender wells (17) and frame (20). Fender skirts will not be reused.

- b. Mark steering shaft (64) where it connects to upper steering coupler (65) and gear box (66).

- c. Remove two bolts with captive washers (67) from upper steering coupler (65) and gear box (66).

- d. Remove steering shaft (64) from vehicle.

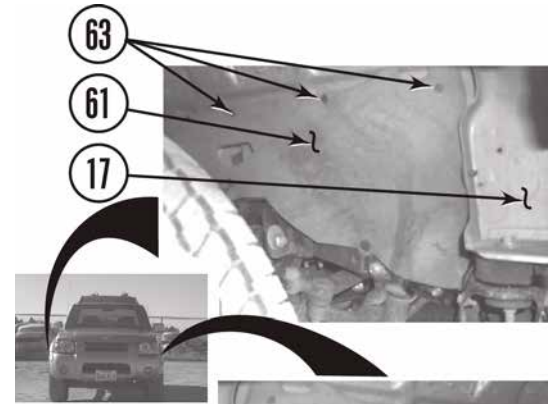

5. Heater core hoses and AC lines.

- a. If necessary, cut zip tie (67) from upper and lower heater hoses (68 and 69).

- b. Remove two clamps (70) and upper and lower heater hoses (68 and 69) from firewall (71).

- c. Remove two bolts (72 and 73) and two clamps (74 and 75) from AC line (76).

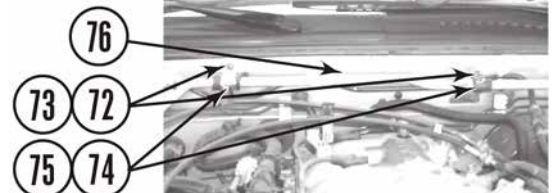
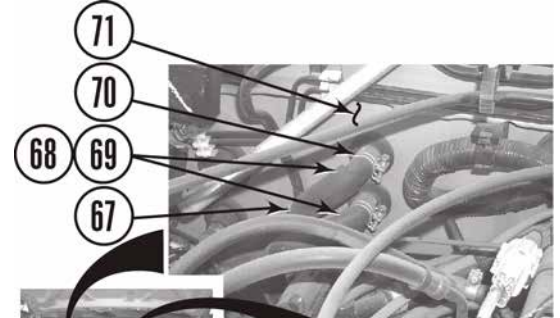

6. Power steering reservoir.

- a. Remove two nuts (77) from power steering bracket (78) and passenger side wheel well (79).

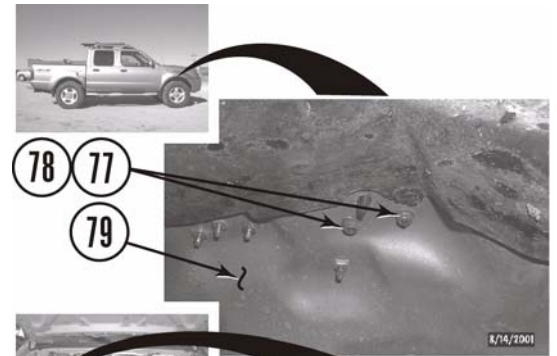

- b. Remove two bolts with captive washers (80) and power steering bracket (78) from passenger side wheel well (79).

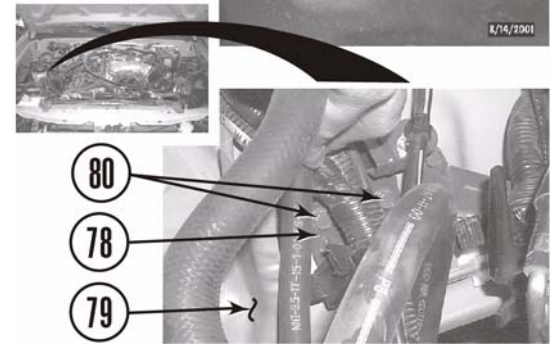

- c. Remove power steering bracket (78) from power steering reservoir (81) and vehicle. Rest power steering reservoir on passenger side wheel well. Do not disconnect power steering hoses from the power steering reservoir.



7. Brake lines.

- a. Remove two bolts (82) and brake line cover (83) from passenger side frame (20).

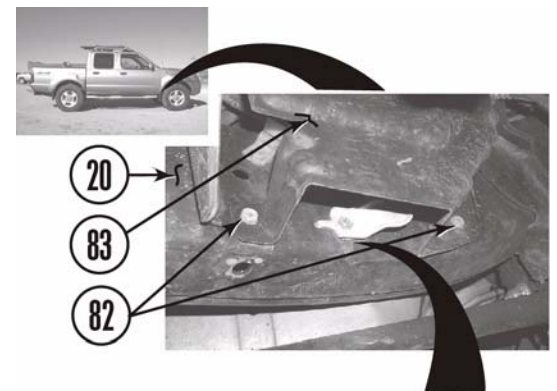

- b. Remove two bolts (84) and two bracket harness (85) from passenger side frame (20).

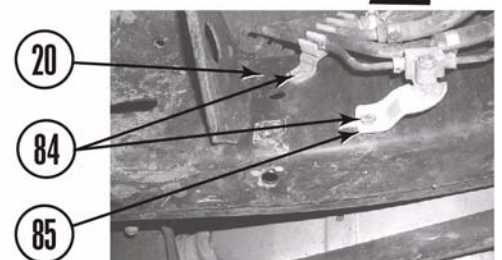

- c. Remove two bolts (84) and two bracket harnesses (85) from inside passenger side frame (20).

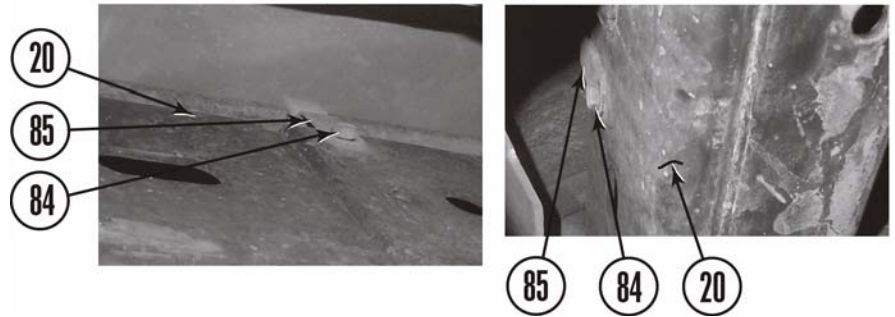

- d. Remove clip (86) from two brake lines (87) and passenger side wheel well (79).

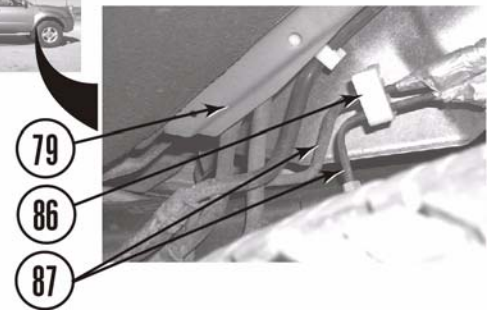

- e. Remove wire harness (89) from clip (90) on passenger side wheel well (79) in front of power steering reservoir (81).

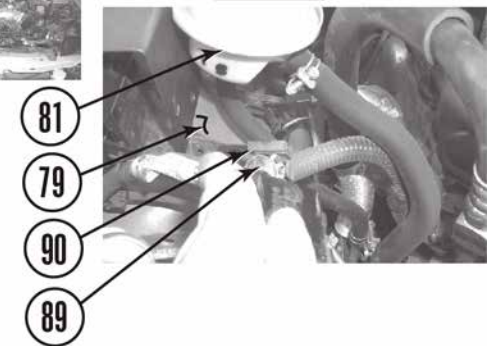

- f. Remove wire harness (91) from clip (92) on passenger side wheel well (79) behind power steering reservoir (81).

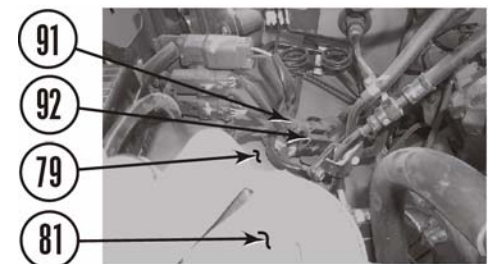

- g. Remove clip (93) and ground strap (94) from passenger side wheel well (79).

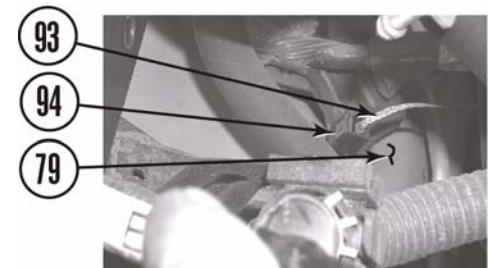

h. Remove two brake lines (87) from two clips (86), bracket (95), and fire wall (71).

i. Remove two fuel lines (96) from clip (86), bracket (95), and fire wall (71).

j. Remove two bolts (97) and bracket (95) from fire wall (71).

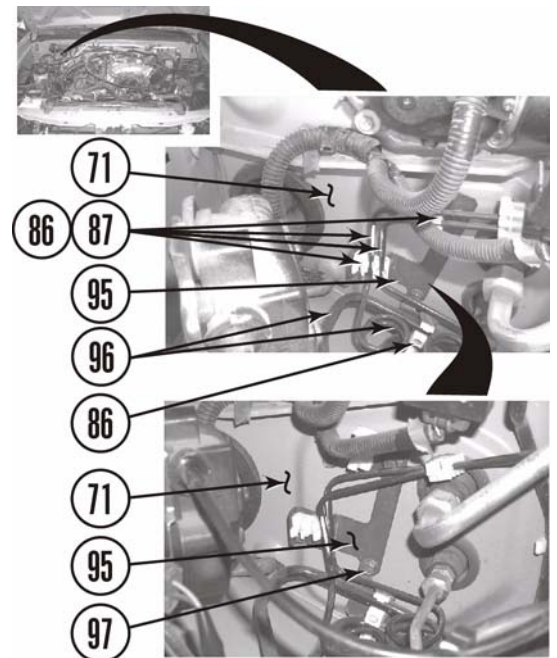

k. Remove clip (93) and ground strap (94) from driver side wheel well (79).

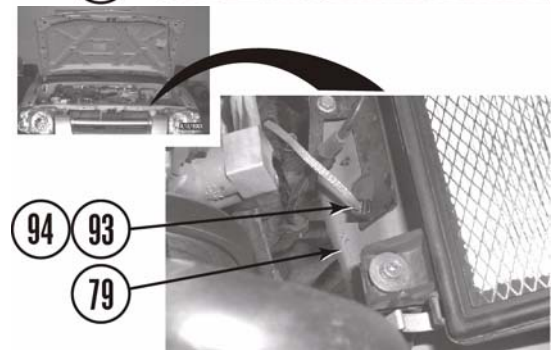

l. Remove two bolts (98) and bracket (99) from hose (100) and frame (20) driver side.

m. Remove bolt (101) and bracket (102) from hose (100) and frame (20) driver side.

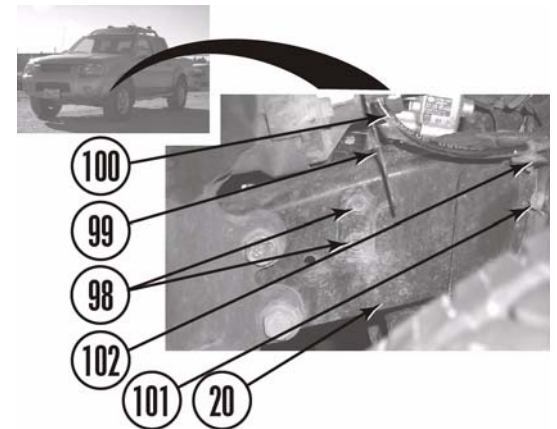

8. Cab drive shaft loop and parking brake cable.

a. Remove two bolts with captive washers (103) and cab drive shaft loop (104) from cab (105) around drive shaft (106).

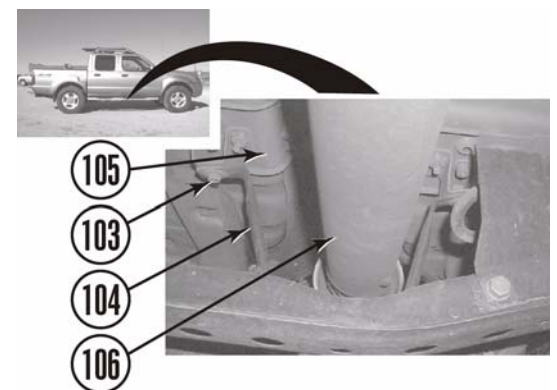

- b. Remove two bolts with captive washers (107) from parking brake pivot assembly (108) and passenger side frame (20).
- c. Remove bolt (109) from parking brake housing (110) and bracket (111).
- d. Remove parking brake cable nipple (112) from parking brake pivot assembly (108).

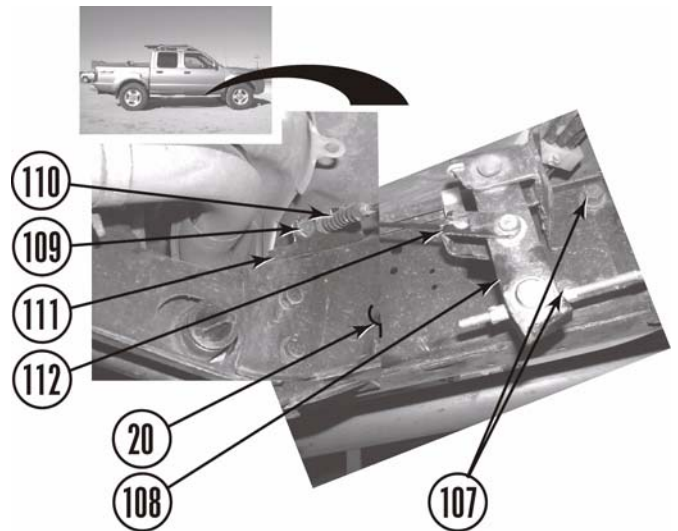

- e. Remove nut (113), clamp (114), and parking brake housing (110) from cab stud (115). Pull cable housing to gain 1/2" of length.

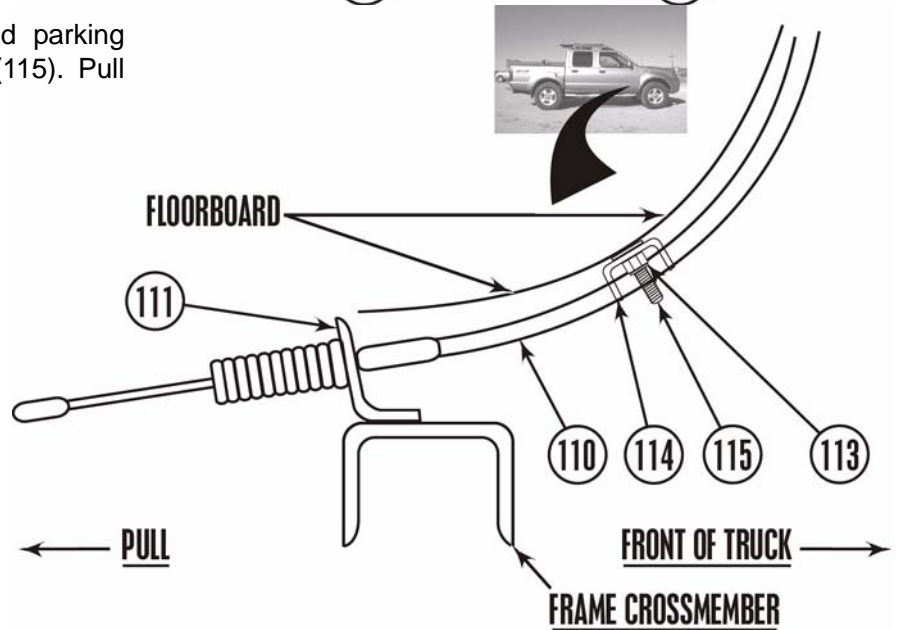

9. Parking brake cable (2002 4 and 6 cylinder).

- a. Remove bolt (115a) and parking brake housing bracket (115b) from frame (20) driver side.

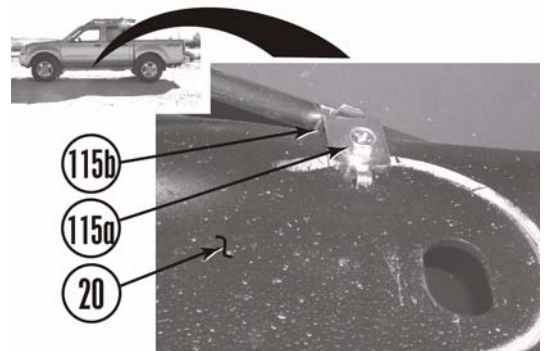

10. Inside cab.

- a. Remove eight plastic screws (116) and two scuff plates (117) from cab (105).

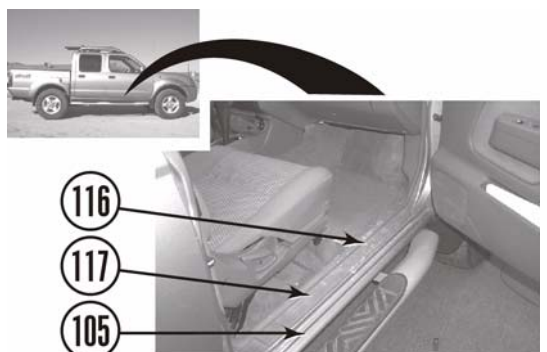

- b. Remove two bolts (118), two clips (119), and two kick plates (120) from cab (105).

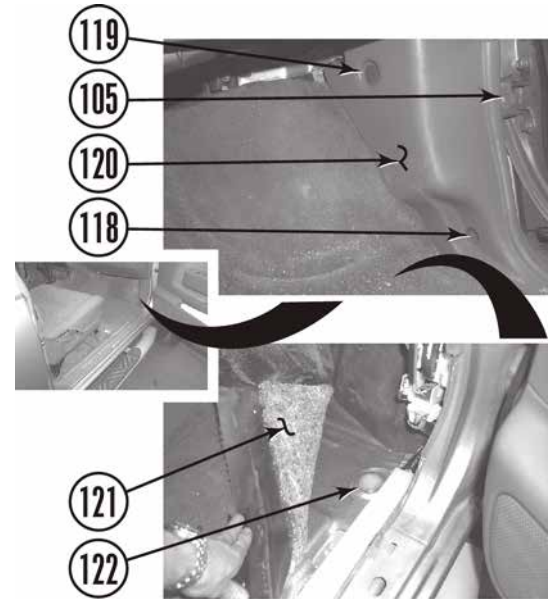

- c. Pull carpet (121) back and expose two plastic bolt lockers (122).

⚠NOTE

Vehicles equipped with a automatic transmissions should skip step B.11.a through B.11.c.

11. Manual and 4wd shift lever console.

⚠CAUTION

Manual and 4WD shift knobs are very difficult to unscrew. It may be necessary to wrap knob with a rag and use channel lock pliers to remove knob. Care should be taken not to destroy the shift knobs.

- a. Remove manual shift knob (123) and 4wd shift knob (124) from manual shift lever (125) and 4wd shift lever assembly (126).
- b. Remove four screws (127) from manual shift lever console (128) and cab (105).
- c. Remove manual shift lever console (128), outer manual shift lever boot (129), and 4wd shift lever boot (130) from vehicle.

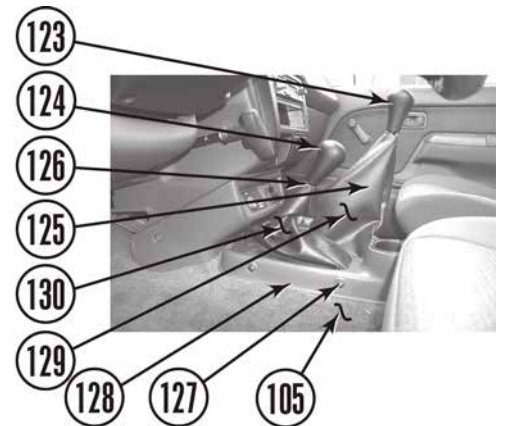

⚠CAUTION

Manual and 4WD shift knobs are very difficult to unscrew. It may be necessary to wrap knob with a rag and use channel lock pliers to remove knob. Care should be taken not to destroy the shift knobs.

⚠CAUTION

2002 model year vehicles have a clip in manual shift lever console with an attached manual and 4wd shift lever boot. Care should be taken so that the shift lever console is not destroyed during removal.

⚠NOTE

2001 model year vehicles should skip step B.18.a through B.18.e.

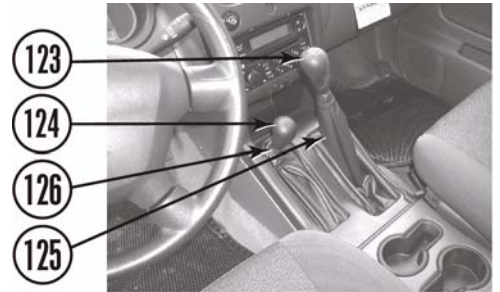

12. Manual and 4wd shift lever console (2002 only).

- a. If applicable remove manual shift knob (123) and 4wd shift knob (124) from manual shift lever (125) and 4wd shift lever assembly (126).
- b. Carefully pull shift lever console (126a) and remove from storage console (126b).
- c. Remove four screws (126c), four clips (126d), and dash console cover (126e) from dash (126f).



- d. Disconnect emergency flasher wiring connector (126g) and lighter wiring connector (126h) from dash console cover (126e).

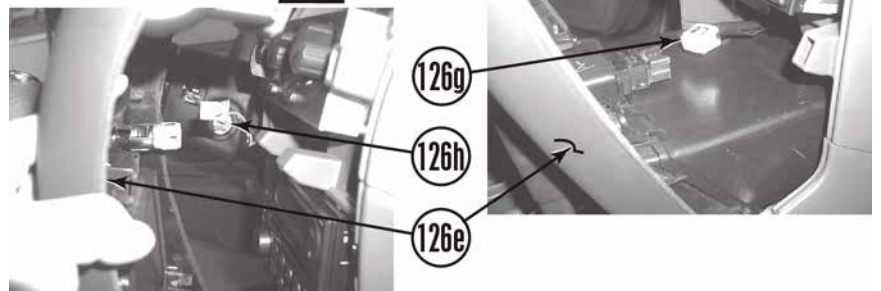
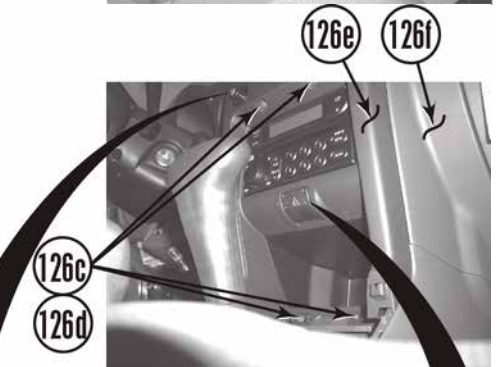

- e. Remove six screws (126i) from storage console (126b) and cab (105).

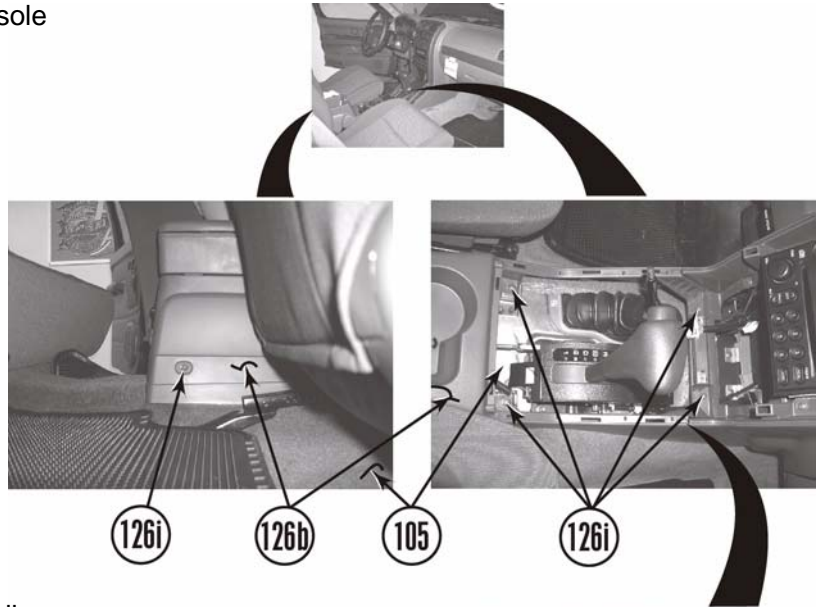

- f. Lift storage console (126b) and locking clips (126j) from dash (126f).

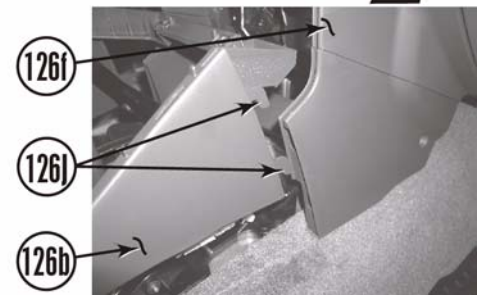

- g. Remove storage console (126b) from vehicle.

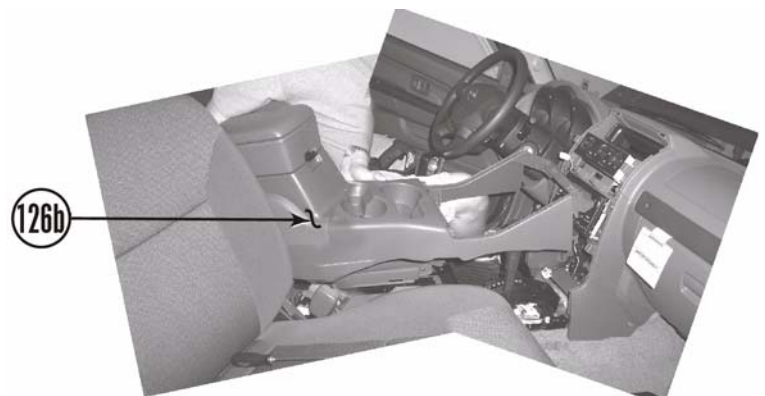

13. Manual trans. shift lever and 4wd shift lever.

- a. Remove two zip ties (131) from manual shift lever boot (132) and manual shift lever (125).
- b. Lift manual shift lever boot (132) and remove spring clip (133) from transmission (134) and manual shift lever (125).
- c. Remove manual shift lever (125) from transmission (134).
- d. If possible, remove manual shift boot (132) and plastic pivot bushing (135) from manual shift lever (125).

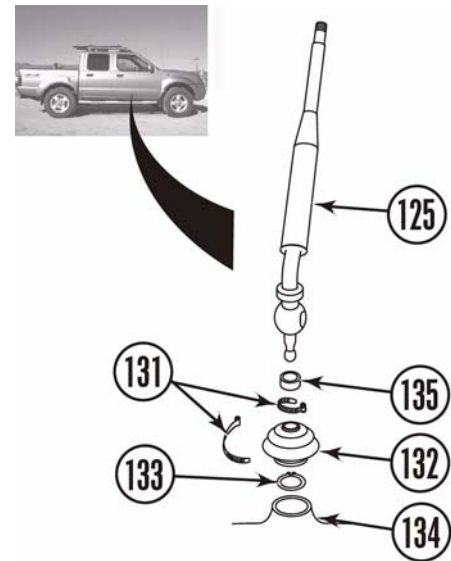

- e. If so equipped, remove five screws (136), 4wd intermediate shift boot (137), and 4wd inner shift boot (138) from cab (105) and 4wd shift lever assembly (126).

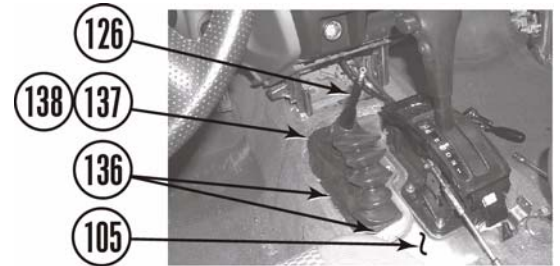

- f. Remove two bolts (139) and 4wd shift lever pivot (140) from 4wd shift lever assembly (126) and transfer case (141).
- g. Remove nut (142) and 4wd shift lever assembly (126) from transfer case linkage (143) and vehicle.

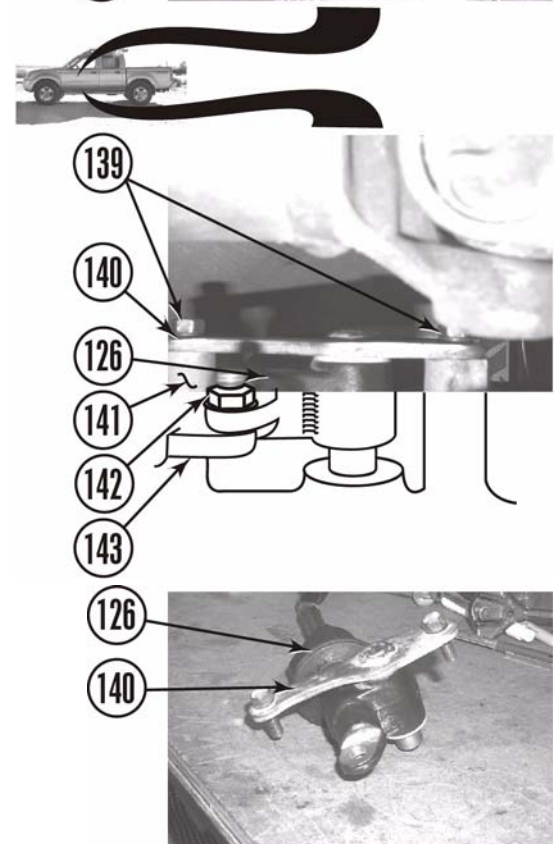

14. 4wd with automatic transmission console.

- a. Remove eight bolts (144) from front 4wd with automatic transmission console (145), rear console (146), and cab (105).
- b. Remove rear console (146) from vehicle.

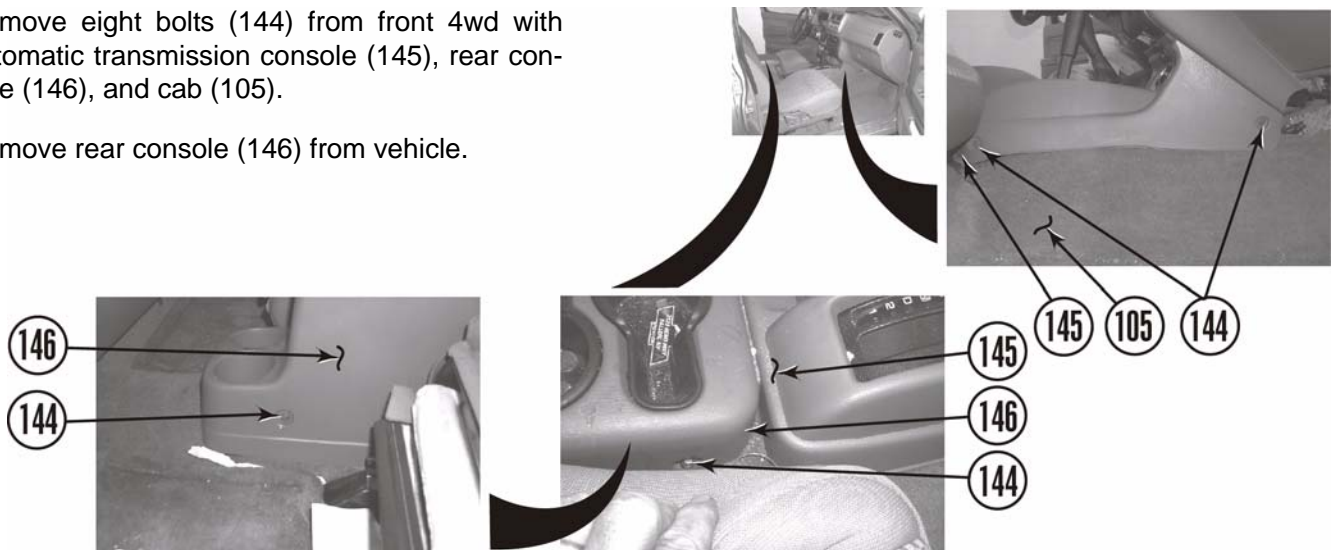

- c. Lift front 4wd with automatic transmission console (145) and remove eight clips (147) and automatic shifter cover (148) from 4wd with automatic transmission console.

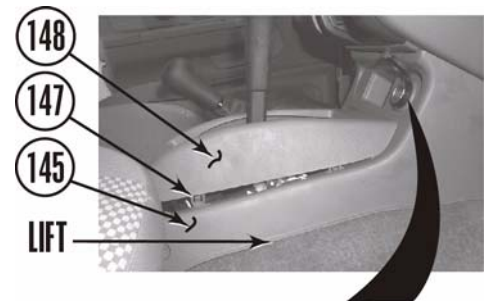

- d. Lift front 4wd with automatic transmission console (145) and disconnect wiring harness (149) from lighter (150).

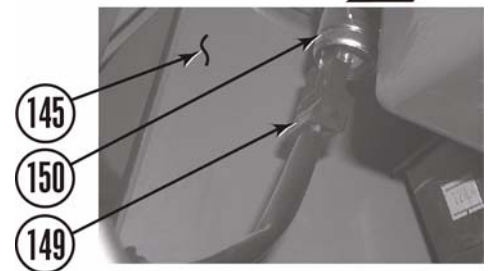

- e. Remove front 4wd with automatic transmission console (145) and outer 4wd shift boot (129) from cab (105) and vehicle.



- f. Remove five screws (136), 4wd intermediate shift boot (137), 4wd inner shift boot (138), from cab (105) and 4wd shift lever assembly (126).

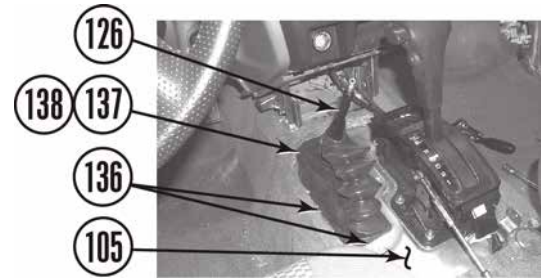

- g. Remove two bolts (139) and 4wd shifter pivot (140) from 4wd shift lever assembly (126) and transfer case (141).
- h. Remove 4wd shift lever assembly (126) from transfer case (141) and vehicle.
- i. Remove nut (142) and 4wd shift lever assembly (126) from transfer case linkage (143) and vehicle.

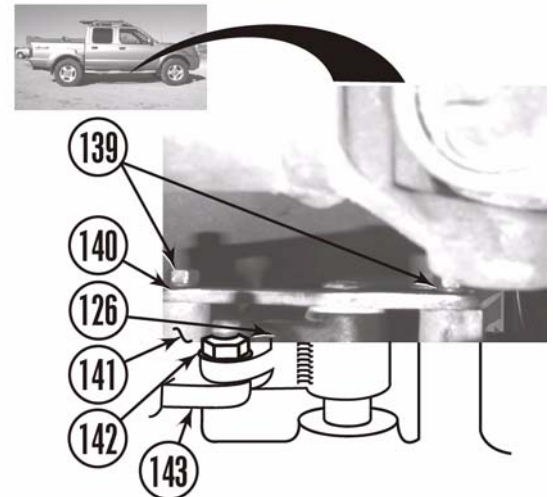

15. Fuel filler.

⚠WARNING
 Use extreme caution when working near fuel lines and fuel tank. Clean up spilled fuel immediately. Any spark could cause an explosion or fire resulting in serious personal injury and property damage.

- a. Remove three screws (151) from bed (152) and fuel filler assembly (153).

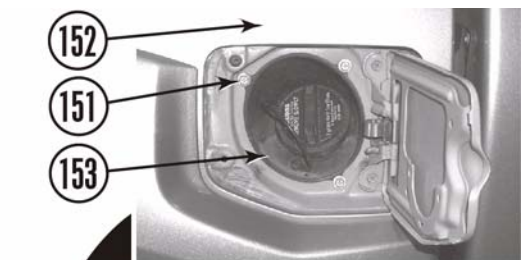

- b. Remove two small clamps (154) and a large clamp (156) from two vent lines (157), fuel hose (158) and fuel tank (159). Remove fuel filler assembly from vehicle.

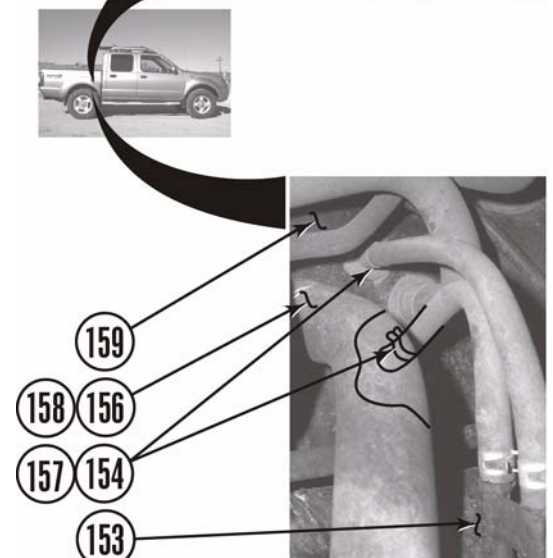

16. Rear bumper.

- a. Measure distance from the bed (152) to the rear bumper (160). Record measurement.

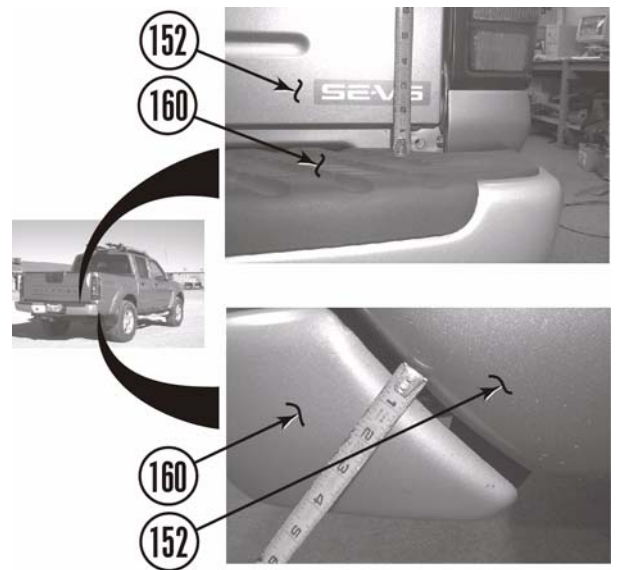

- b. Disconnect two license plate lights (161) from rear bumper (160).

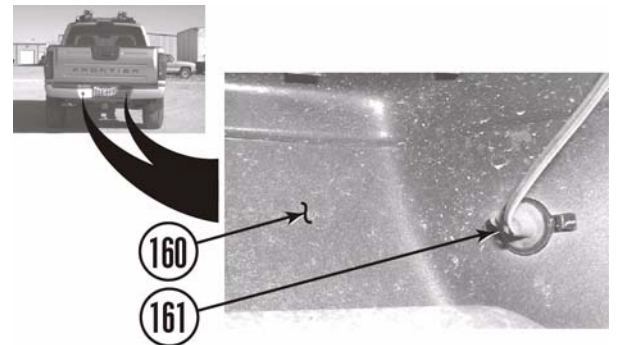

NOTE
The frontier uses one style of rear bumper brackets for the standard, extended, and crew cab bed styles but different holes. It is necessary to mark which set of bolt holes your truck uses on these rear bumper brackets for installation. Match these holes with the *kit* rear bumper brackets for installation.

- c. Remove six nuts (162) and two triple bolt fasteners (163) from frame (20) and rear bumper brackets (164).

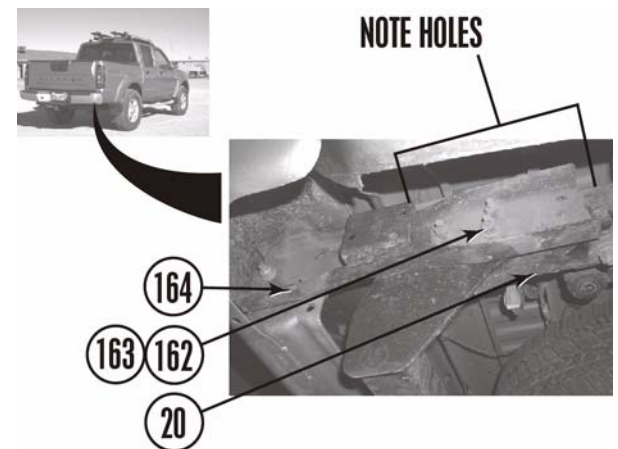

- d. Remove rear bumper (160) and rear bumper brackets (164) from frame (20).

- e. Remove four nuts (165), two double bolt fasteners (166), and two rear bumper brackets (164) from rear bumper (160).

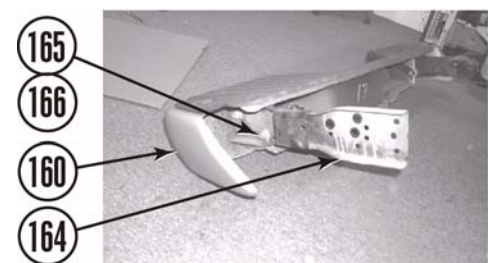

C. Install the *kit*.

1. Prepare to lift body from frame.

⚠WARNING

Failure to replace the OEM cab mounting hardware (except mounting bolts in the *kit*) in the stock locations could result in serious personal injury or damage to the vehicle.

- a. Measure distance from the cab (105) to the bed (152). Record measurement for later cab to bed alignment reference in these instructions.
- b. Loosen but do not remove four nuts (167) and four body bolts with captive washers (168) from core support mounting pads (169), core support (14), frame mounting pads (170), and cab (105).

⚠WARNING

Use extreme caution when lifting cab from frame. Ensure lifting device is securely placed. Keep hands out from between frame and cab, or serious personal injury could result.

⚠CAUTION

Continually check hoses, wires, lines, etc. to be sure that everything is flexing properly and not binding, or damage to the vehicle could result. Be especially careful of the a/c hoses at the firewall, the belt pulley, and at the core support. Ensure brake lines stretch while lifting. Bending the lines to gain ample slack may be necessary. Be extremely careful not to kink the lines.

⚠NOTE

Ensure stock spacers and cab mounting pads stay on vehicle unless otherwise specified in these instructions. *Kit* spacer blocks are installed in addition to the stock spacers and cab mounting pads.

- c. Remove nut (167) and lower bushing (171) from bolt (172), core support mounting pad (169), and passenger side core support (14).
- d. Remove nut (167) and lower bushing (171) from bolt (172), frame mounting pad (170), and cab (105). Push bolt and plastic bolt locker (122) up through cab passenger side.
- e. Remove bolt with captive washer (168), two nuts (173), triangular bracket (174) and lower bushing (171) from frame mounting pad (170) and cab (105) passenger side.
- f. Remove two bolts with captive washers (175) and bracket (176) from cab (105) passenger side.
- g. Remove bolt with captive washer (168) and lower bushing (171) from frame mounting pad (170) and cab (105) passenger side.

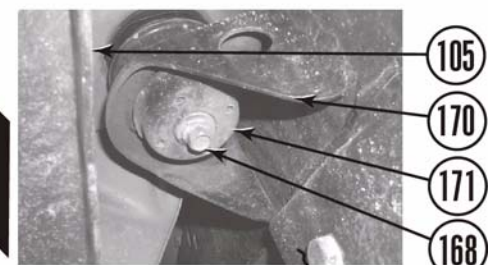
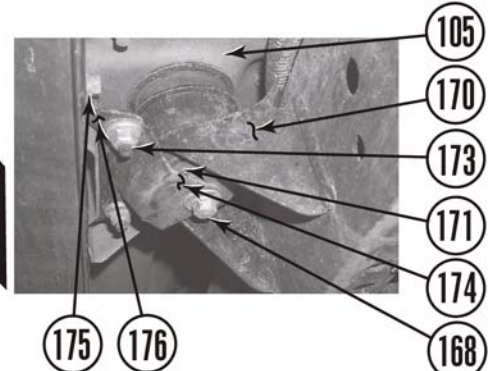
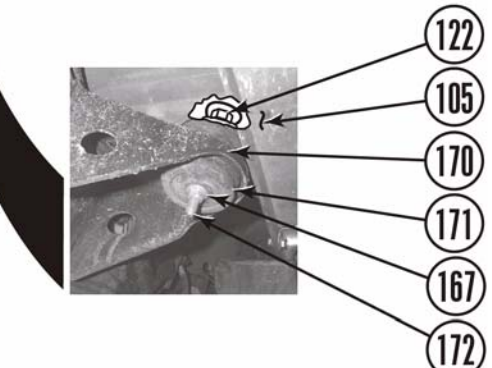
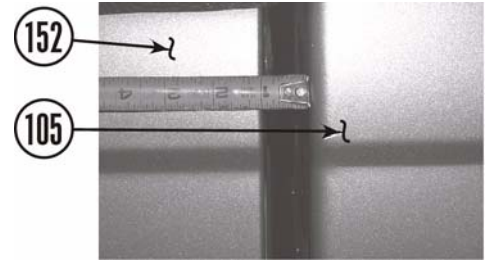

2. Lift cab and install passenger side spacer blocks.

- a. Using a hydraulic jack and a wooden block, slowly lift the cab (105) passenger side just high enough to position the four *kit* spacer blocks (177) between the cab and on top of top body bushings (178).
- b. Install *kit* 7/16" x 7" bolt (179) through *kit* 7/16" USS washer (180), core support (14), *kit* 3" x 3" spacer block (177), top body bushing (178), core sport mounting pad (169), lower body bushing (171), *kit* 7/16" USS washer, and *kit* 7/16" nylock nut (181).
- c. Install *kit* 7/16" x 7" bolt (179) through *kit* 7/16" USS washer (180), cab (105), *kit* 3" x 3" spacer block (177), top body bushing (178), frame mounting pad (170), lower body bushing (171), *kit* 7/16" USS washer, and *kit* 7/16" nylock nut (181).
- d. Install *kit* 10mm x 190mm bolt (182) through *kit* 7/16" USS washer (180), triangular bracket (174), lower bushing (171), frame mounting pad (170), top body bushing (178), *kit* 3" x 3" spacer block (177), and cab (105). Do not tighten.
- e. Install *kit* 12mm x 210mm bolt (183) through *kit* 1/2" USS washer (184), lower bushing (171), frame mounting pad (170), top body bushing (178), *kit* 3" x 3" spacer block (177), and cab (105). Do not tighten. Lower cab (105) onto frame (20).

3. Install the cab driver side spacer blocks.

- a. Repeat steps C.2.a. through C.2.f. for cab driver side.

4. Finish cab spacer block installation.

- a. Remove four *kit* 7/16" x 7" body bolts (179), two *kit* 10mm x 190mm bolts (182), and two *kit* 12mm x 210mm bolts (183) one at a time from core support, cab, and frame mounting pads (14, 105, and 170), coat threads with Loctite® and reinstall.
- b. Adjust cab (105) to bed (152) clearance using measurements from step C.1.a. Tighten bolts (179, 182, and 183) and nuts (181) to 55 ftlbs.

5. Finish cab driver side spacer block installation.

- a. Repeat steps C.4.a. through C.4.b. for cab driver side.

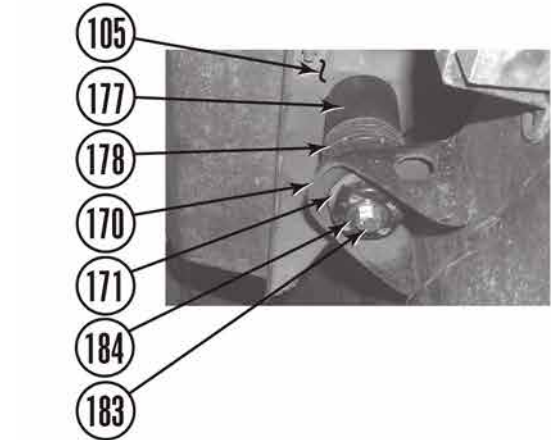
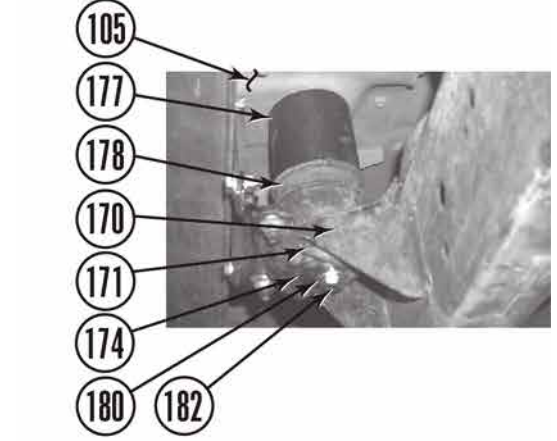
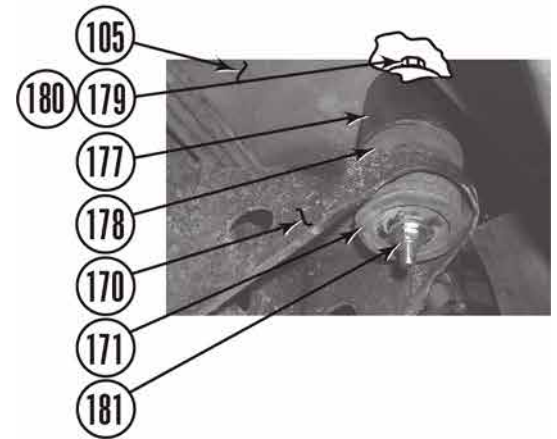
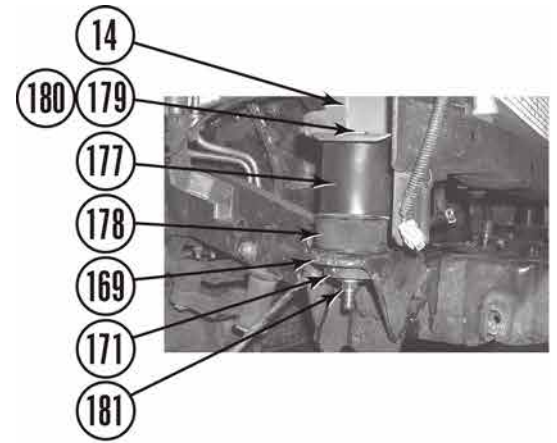

6. Install the bed passenger side spacer blocks.

NOTE

If your vehicle comes with a factory installed class three hitch, it may be necessary to remove the whole hitch including frame stiffeners in order to install *kit* bolts at rear of frame.

- a. Loosen but do not remove six bed mounting nuts (185) from bed (152) and frame mounting pad (170).
- b. Remove three nuts (185), thick washers (187), rubber bushings (186), and two bed bolts (188) from three frame mounting pads (170) and passenger side bed (152).

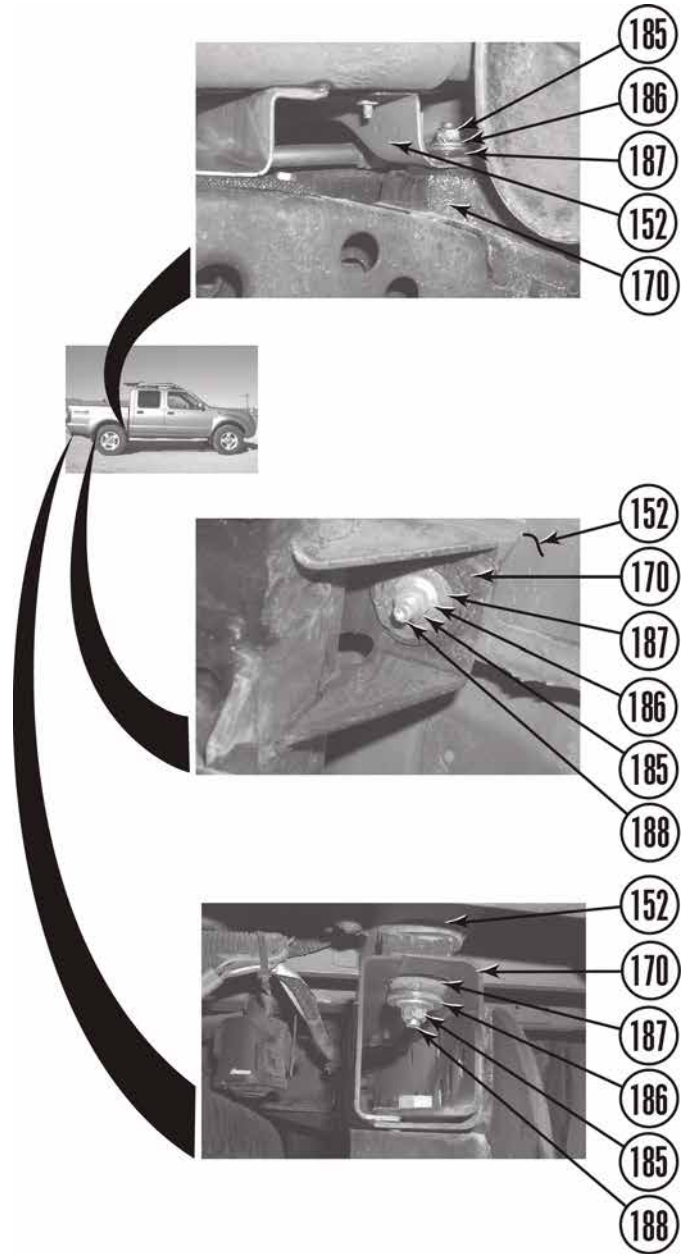

- c. Using a hydraulic jack and a wooden block, slowly lift the bed (152) passenger side just high enough to position the *kit* spacer blocks (189 and 190) between the bed and frame mounting pads (170).
- d. Position *kit* 2" x 3" x 2 3/8" bed spacer block (189) on the front frame mounting pad stud (170) and two *kit* 3" x 2" spacer blocks (190) on the last two frame mounting pads (170) under rubber bushings (191) and bed (152).
- e. Install *kit* 7/16" USS washer (180) and nut (185) on *kit* 2" x 3" x 2 3/8" bed spacer block (189) and front frame mounting pad stud (170).
- f. Install *kit* 7/16" x 1 1/2" bolt (192) through *kit* 7/16" USS washer (180), large washer (186), rubber bushing (187), bed (152), rubber bushing (187), bed (152), rubber bushing (191), *kit* 2" x 3" x 2 3/8" bed spacer block (189), *kit* 7/16" USS washer, and *kit* 7/16" nylock nut (181) on the front frame mounting pad (170).
- g. Install *kit* 1/2" x 5" bolt (193) through *kit* 1/2" USS washer (184), rubber bushings (187), second frame mounting pad (170), *kit* 3" x 2" spacer block (190), rubber bushing (191), bed (152), *kit* 1/2" USS washer (184), and *kit* 1/2" nylock nut (194). Do not tighten.
- h. Install *kit* 1/2" x 5 1/2" bolt (195) through *kit* 1/2" USS washer (184), rubber bushing (187), rear frame mounting pad (170), 3" x 2" spacer block (190), rubber bushing (191), bed (152), *kit* 1/2" USS washer (184), and *kit* 1/2" nylock nut (194). Do not tighten.

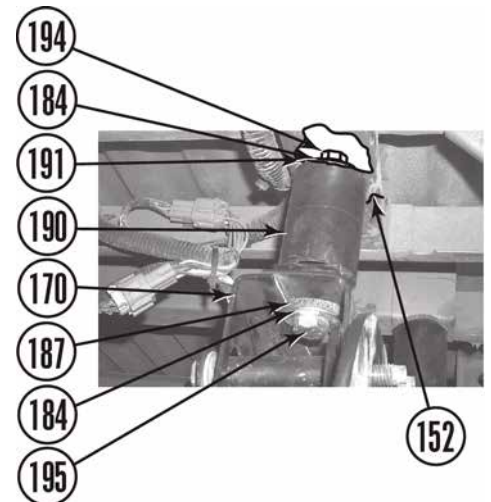
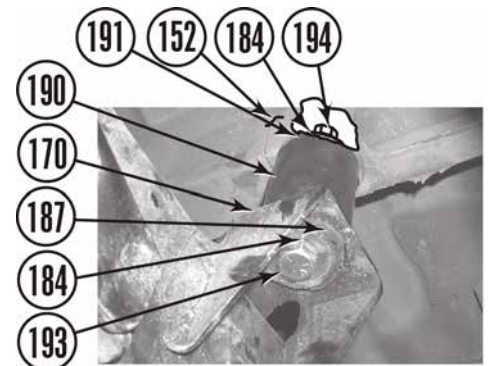
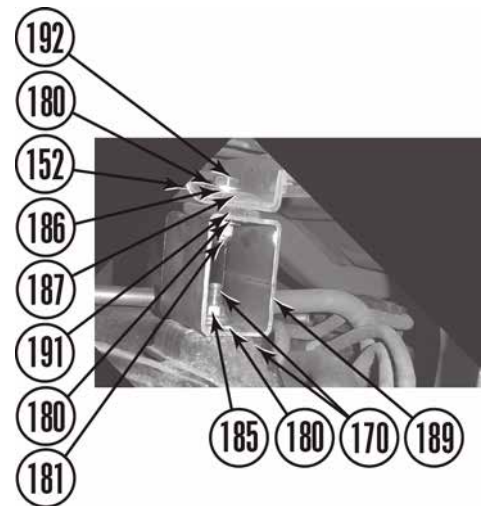

- 7. Install the bed driver side spacer blocks.
 - a. Repeat steps C.6.b. through C.6.h. for bed driver side.
- 8. Finish the bed spacer block installation.
 - a. Remove eight nuts (185, 181, and 194) and six bolts (192, 193, and 195) one at a time, coat threads of *kit* bolts with Loctite®, and install.
 - b. Adjust bed (152) to cab (105) clearance using measurements from step C.1.a. Tighten bolts (192, 193, and 195) and nuts (185, 181, and 194) to 55 lbs-ft.

9. Install *kit* cab brackets.

- a. Install *kit* cab bracket (196) on cab (105) with two bolts with captive washers (175).
- b. Install bracket (176) on *kit* cab bracket (196) with two *kit* 5/16" x 1" bolts (197), four *kit* 5/16" USS washers (198), and two *kit* 5/16" nylock nuts (199).
- c. Install triangular bracket (174) on bracket (176) with two nuts (173).
- d. Repeat steps C.9.a. through C.9.c. for cab driver side.

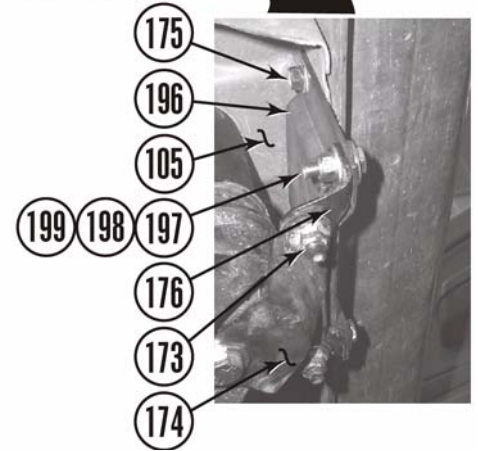

10. Fuel filler assembly.

- a. Remove three clamps (154 and 156) two vent hoses (157) and fuel hose (158) from fuel filler assembly (153).
- b. Cut fuel hose (158) in half as shown.
- c. Install *kit* fuel filler extension (200) on fuel hose (158) with two *kit* #28 clamps (201).
- d. Install fuel hose (158) on fuel filler assembly (153) with clamp (156).
- e. Install two *kit* vent hoses (202) on fuel filler assembly (153) with two clamps (154).
- f. Position two clamps (154) on two *kit* vent hoses (202).
- g. Install fuel filler assembly (153) on fuel tank (159) with three clamps (154 and 156).
- h. Install fuel filler assembly (153) on bed (152) with three screws (151).

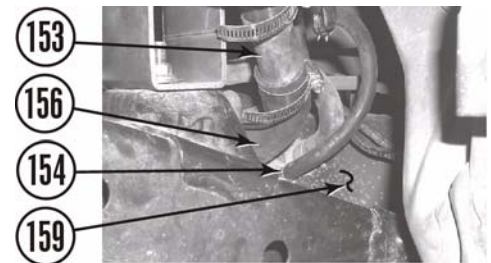
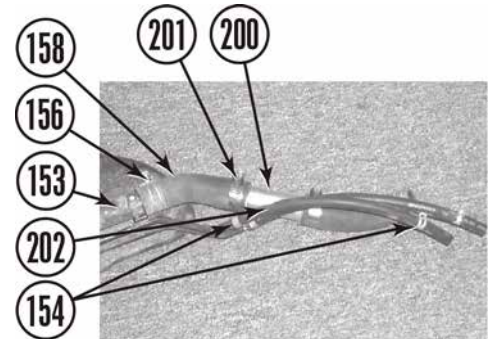
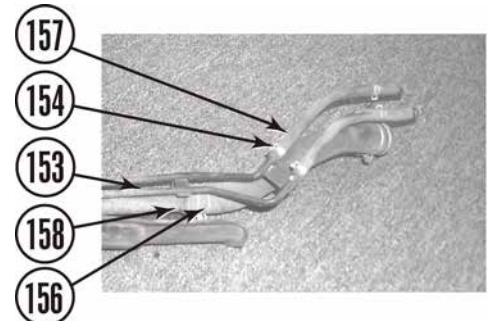

11. Inside cab.

- a. Smooth carpets (121) into corners of cab (105).
- b. Install two kick plates (120) and two scuff plates (117) on cab (105) with two bolts (118), two push clips (119), and eight plastic screws (116).

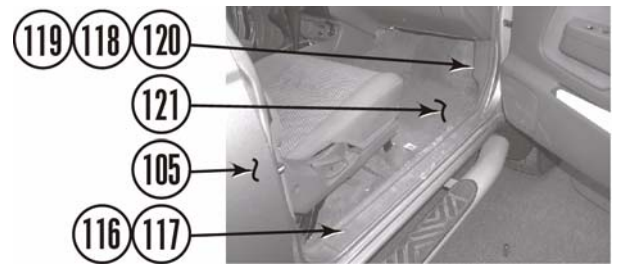

12. 4wd shift lever extension.

- a. Remove two zip ties (131) from 4wd shift lever assembly (126) and boot (203).
- b. Position boot (203) on 4wd upper shift lever (204). Mark 4wd upper and lower shift lever (205) for reference.
- c. Remove large spring clip (206) from 4wd upper shift lever (204) and 4wd lower shift lever (205).
- d. Remove 4wd lower shift lever (205), large spring clip (206), and spring (207) from 4wd upper shift lever (204).
- e. Remove boot (203), two spring clips (208), and two bushings (209) from 4wd upper shift lever (204).

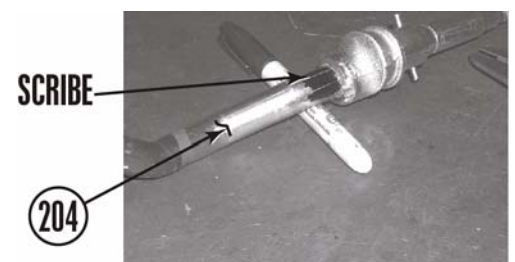
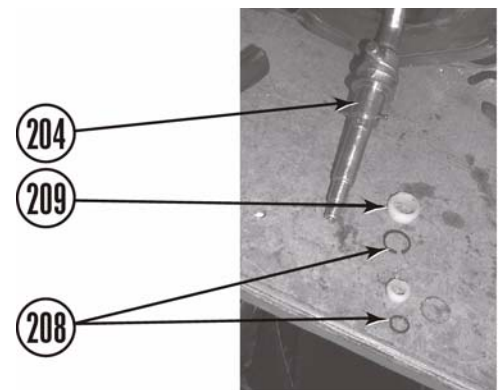
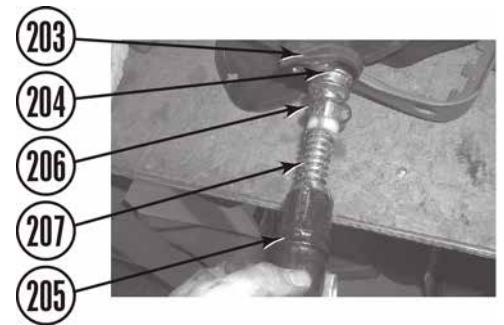
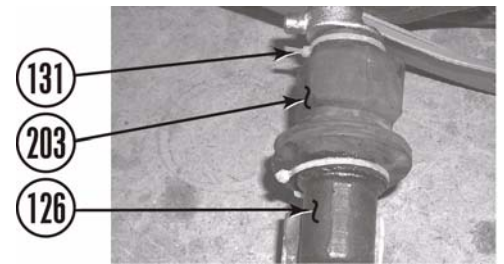

⚠WARNING
A certified welder should perform all welding.

- f. Scribe lines along the side of the 4wd upper shift lever (204) and *kit* 4wd shift lever extension (210) as shown.

- g. Cut the 4wd upper shift lever (204) into two pieces through the lines and deburr as necessary.
- h. Position *kit* 4wd shift lever extension (210) between the two pieces of the 4wd upper shift lever (204). Ensure the *kit* 4wd shift lever extension and 4wd upper shift lever scribed lines align and weld the *kit* 4wd shift lever extension in place.
- i. Install boot (203), two bushings (209), two spring clips (208), spring (207), 4wd lower shift lever (205), and large spring clip (206) on 4wd upper shift lever (204).
- j. Install boot (203) on 4wd shift lever assembly (126) with two *kit* zip ties (211).
- k. Install 4wd shift lever assembly (126) on transfer case (141) with 4wd shifter pivot (140) and two bolts (139).
- l. Install transfer case linkage (143) on 4wd shift lever assembly (126) with nut (142).

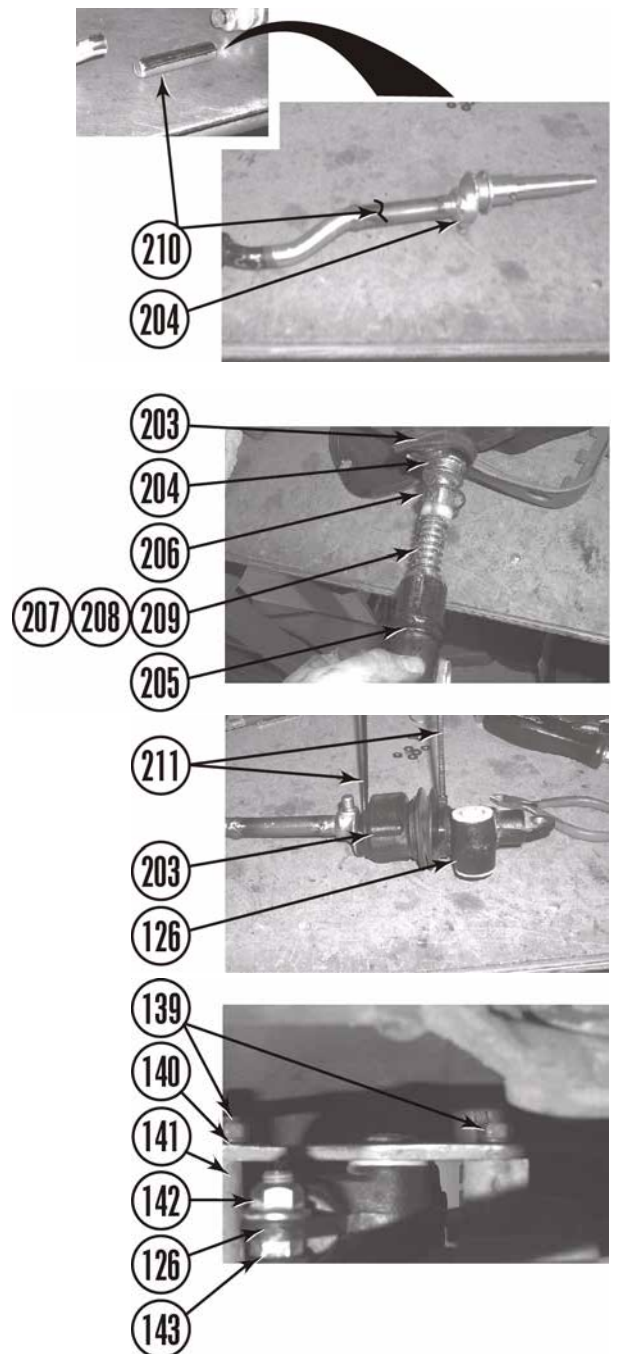

13. Manual shifter lever extension.

- a. Scribe lines along the side of the manual shift lever (125) and *kit* shift lever extension (212) as shown.
- b. Cut the manual shift lever (125) into two pieces through the lines and deburr as necessary.
- c. Position *kit* shift lever extension (212) between the two pieces of the manual shift lever (125), tapered end toward lever bottom. Ensure lever is all the way in and the extension and lever scribe lines align.
- d. Using the holes in the extension as a guide, drill one 1/8" hole through each part of the manual shift lever (125) and the opposite side of the *kit* shift lever extension (212).
- e. Install two *kit* 1/8" x 1" roll pins (212a) in the holes.

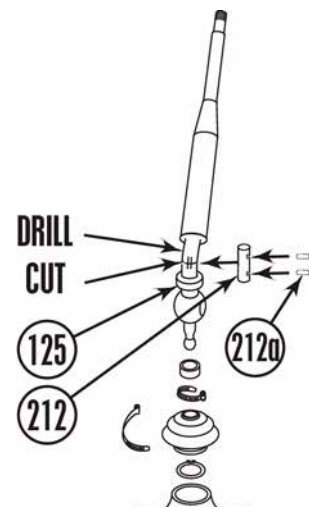

- f. Install plastic pivot bushing (135) and manual shift boot (132) on manual shift lever (125).
- g. Position manual shift lever (125) on transmission (134).
- h. Lift manual shift boot (132) and install spring clip (133) on transmission (134) and manual shift lever (125).
- i. Position manual shift boot (132) on transmission (134) and secure with two *kit* zip ties (213).

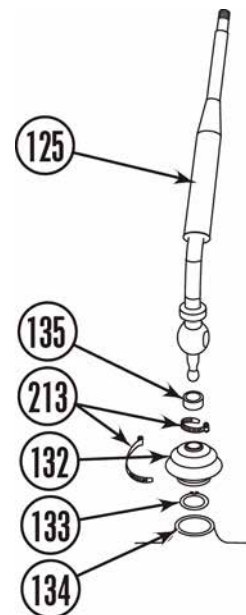

14. 4wd with automatic transmission console.

- a. Install 4wd inner shift boot (138) and 4wd intermediate shift boot (137) on 4wd shift lever assembly (126) and cab (105) with five screws (136).

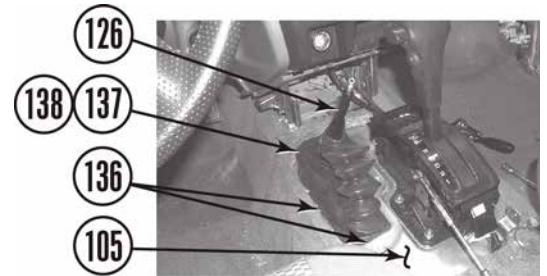

- b. Install 4wd outer shift boot (129) and 4wd with automatic transmission console (145) on cab (105).



- c. Install automatic shifter cover (148) on 4wd with automatic transmission console (145) with eight clips (147).



- d. Install wiring harness (149) on lighter (150).

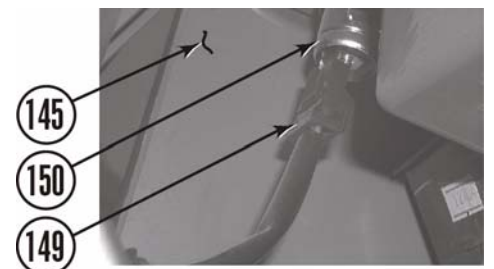

- e. Install rear console (146) and 4wd with automatic transmission console (145) on cab (105) with eight bolts (144).

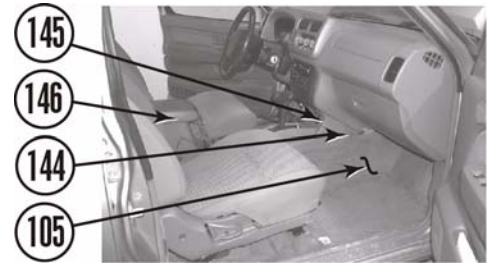

15. Manual shift lever and 4wd shift lever console.

- a. Install 4wd inner shift boot (138) and 4wd intermediate shift boot (137) on 4wd shift lever assembly (126) and cab (105) with five screws (136).

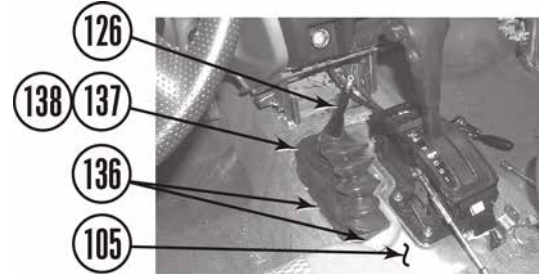

- b. Install outer manual and 4wd shift lever boots (129 and 130) and manual shift lever console (128) on manual and 4wd shift levers (125 and 126) and cab (105) with four screws (127).

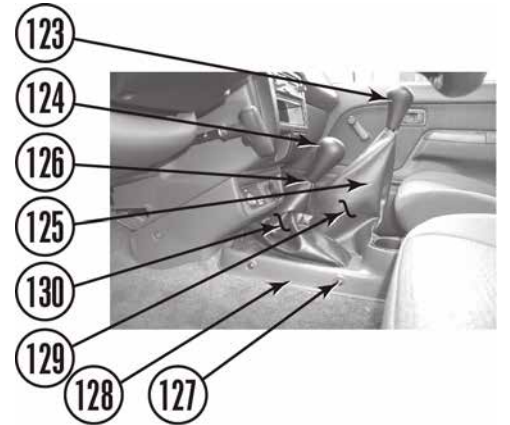

- c. Install manual and 4wd shift knobs (123 and 124) on manual and 4wd shift levers (125 and 126).

16. Manual and 4wd shift lever console (2002 only).

- a. Position storage console (126b) in vehicle and install locking clips (126j) on dash (126f).

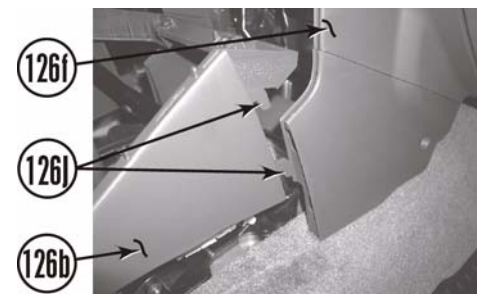

- b. Install storage console (126b) on cab (105) with six screws (126i).

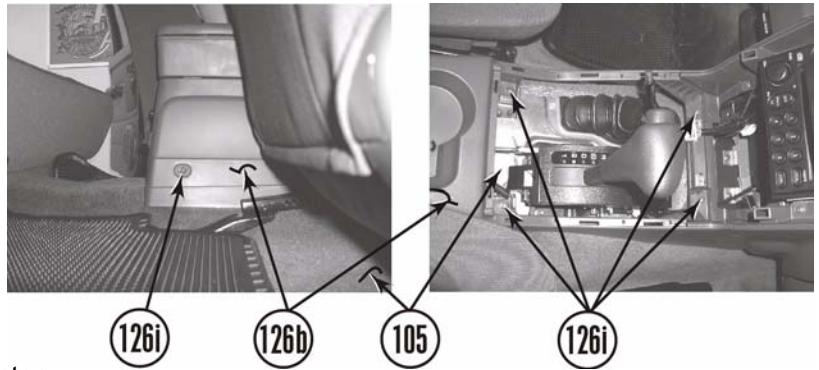

- c. Connect emergency flasher wiring connector (126g) and lighter wiring connector (126h) on dash console cover (126e).

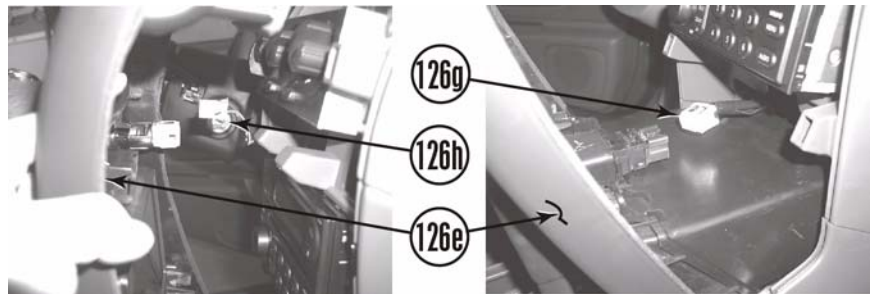

- d. Install dash console cover (126e) on dash (126f) with four screws (126c) and four clips (126d).

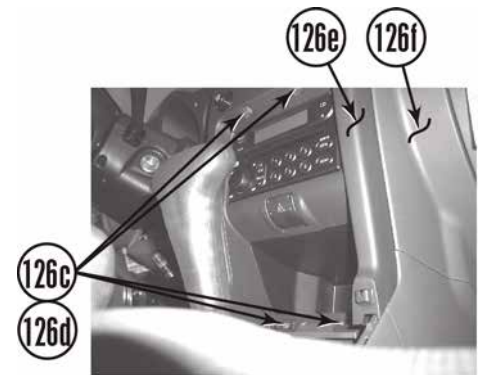

- e. Position shift lever console (126a) on storage console (126b) and if applicable, install manual shift knobs (123 and 124) on manual shift levers (125 and 126).

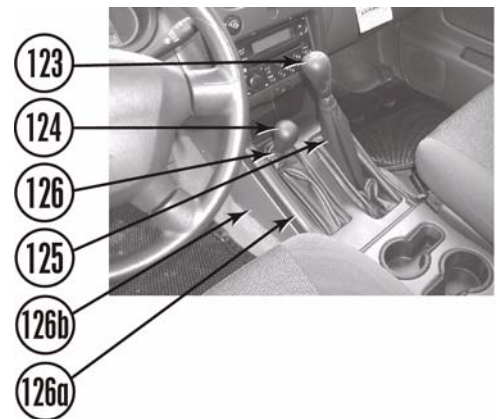

17. Cab drive shaft loop and emergency brake cable.

- a. Install cab drive shaft loop (104) on cab (105) with two *kit* 10mm x 1.5 x 100mm bolts (214), *kit* 3/8" USS washers (198), and *kit* 3/8" x 3" ID tubes (215).
- b. It may be necessary to slightly bend cab drive shaft loop (104) to properly install *kit* 10mm x 100mm bolts (214).

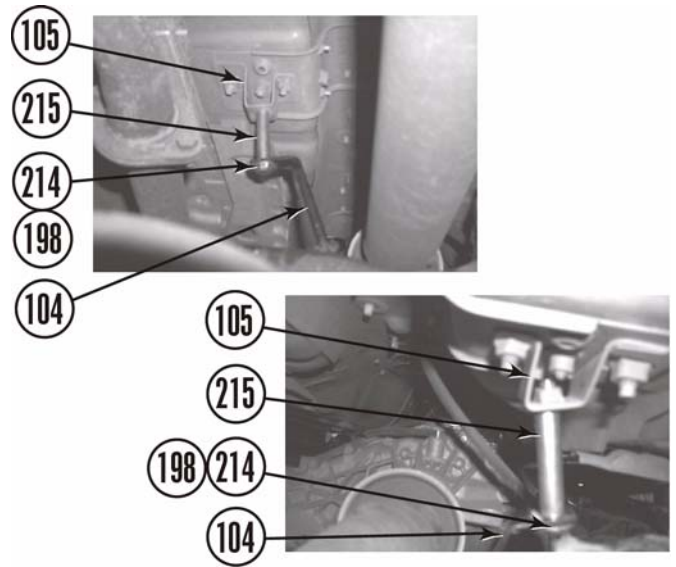

- c. Install parking brake cable nipple (112) on parking brake pivot assembly (108).
- d. Install parking brake housing (110) on bracket (111) with bolt (109).

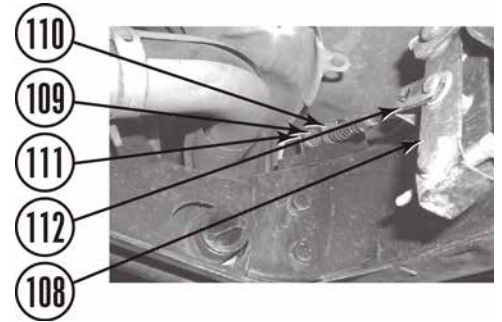

- e. Install parking brake pivot assembly (108) on frame (20) with two bolts with captive washers (107).

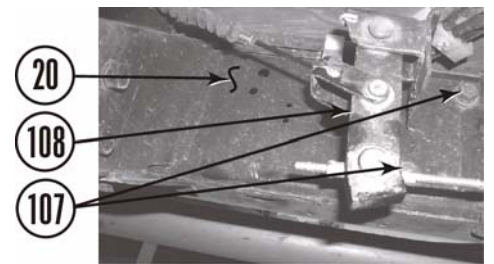

18. Parking brake cable (2002 4 and 6 cylinder).

- a. Install *kit* bracket (115c) on parking brake cable housing bracket (115b) with *kit* 1/4" x 1" bolt (216) two *kit* 1/4" SAE washers (217) and *kit* 1/4" nylock nut (218).

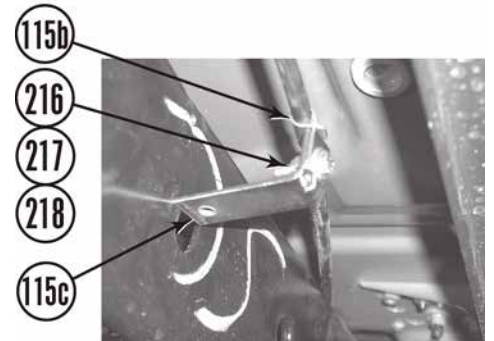

- b. Install *kit* bracket (115c) on frame (20) driver side with bolt (115a).

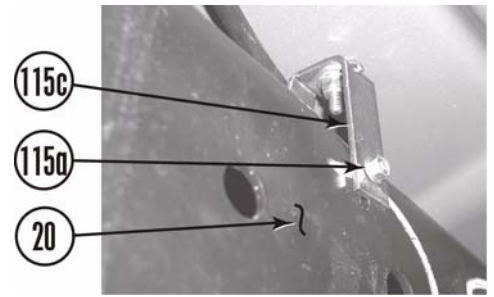

19. 'Brake and vacuum lines.

- a. Install clip (93) and ground strap (94) on driver side wheel well (79).

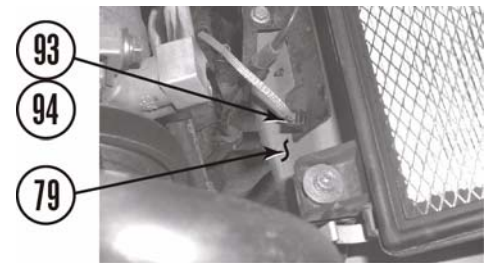

- b. Bend bracket (95) as shown. Install bracket on fire wall (71) with two bolts (97).

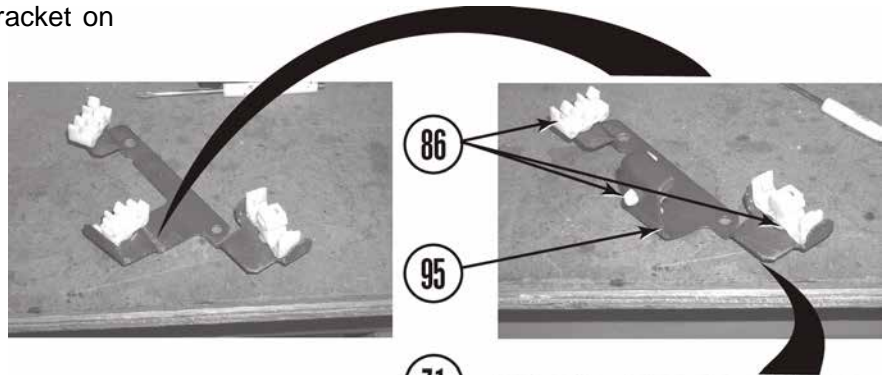

- c. Position two fuel lines (96) in clip (86) on bracket (95).
- d. Position two brake lines (87) on two clips (86) and bracket (95).

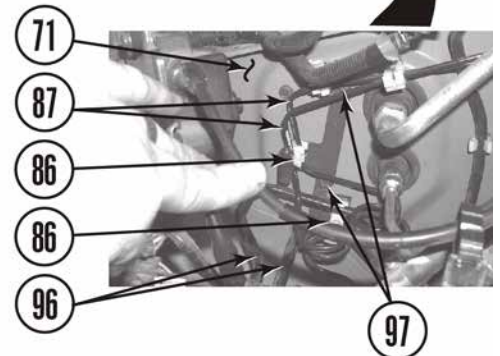

- e. Install clip (93) and ground strap (94) on passenger side wheel well (79).

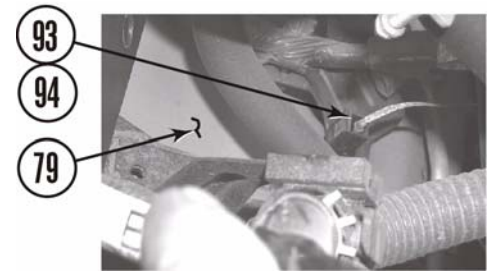

- f. If possible, install clip (86) on two brake lines (87) in passenger side wheel well (79).

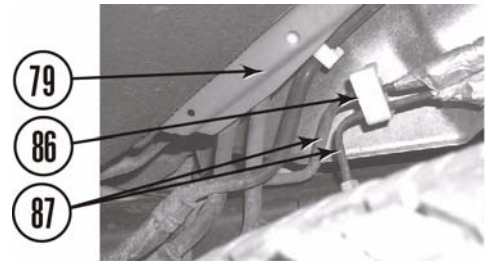

- g. Install two *kit* brackets with studs (219) on frame (20) with two bolts (84).

- h. Install two bracket harnesses (85) on two *kit* brackets (219) with two 1/4" SAE washers (217) and two 1/4" nylock nuts (218).

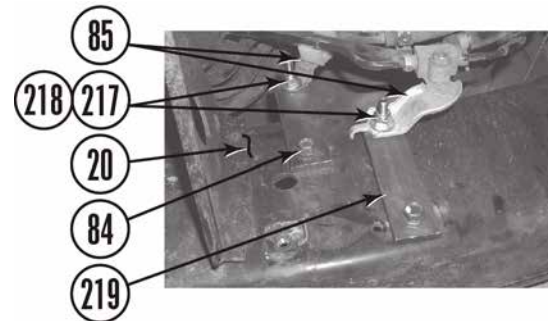

- i. Install brake line cover (83) on frame (20) with two bolts (82).

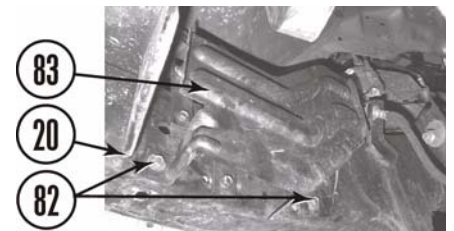

20. Power steering bracket.

- a. Center punch and drill four spot welds on power steering bracket (78) with 9/32" drill bit as shown. Remove power steering slotted bracket (220) from power steering bracket.

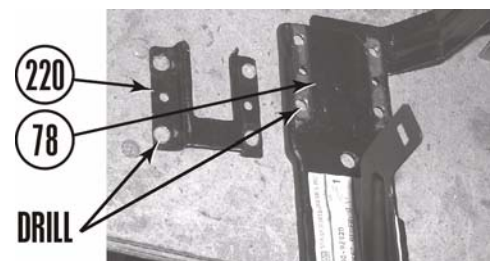

- b. Install power steering slotted bracket (220) on *kit* power steering Z bracket (221) and *kit* power steering C bracket (222) with four *kit* 1/4" x 1" bolts (216), eight 1/4" SAE washers (217), and four *kit* 1/4" nylock nuts (218). Install *kit* 1/4" x 1" bolts as shown.

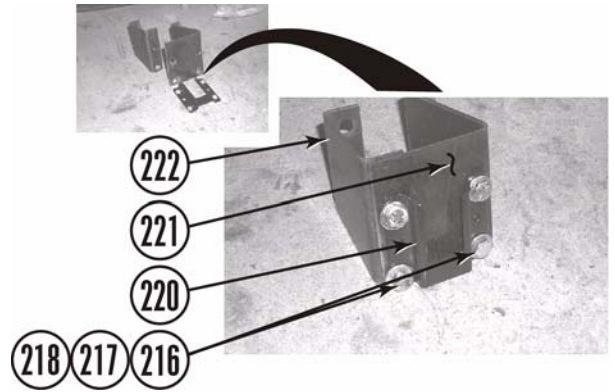

- c. Install *kit* power steering Z bracket (221) and *kit* power steering C bracket (222) on power steering bracket (78) with four *kit* 1/4" x 1" bolts (216), eight 1/4" SAE washers (217), and four *kit* 1/4" nylock nuts (218).

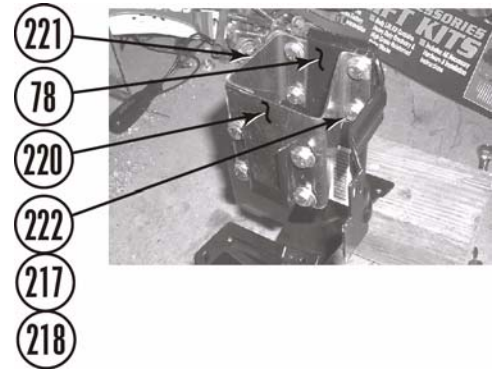

- d. Install power steering reservoir (81) on power steering slotted bracket (220).

- e. Install power steering bracket (78) on passenger side wheel well (79) with two bolts with captive washers (80) and two nuts (77).

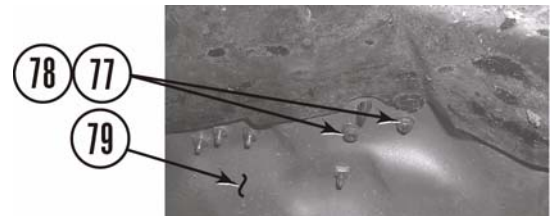

- f. Install *kit* zip tie (223) on power steering pump hose (224) and bracket (225).

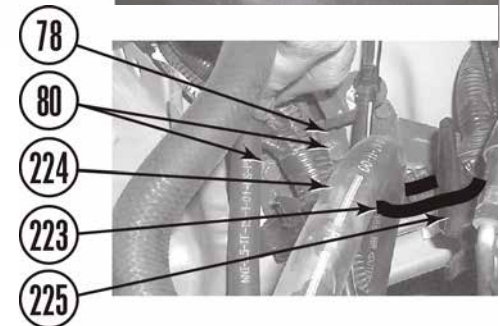

21. Heater core hoses and AC lines.

- a. Remove clip (226) and heater hose clamps (227) from bracket (228).
- b. Install upper and lower heater hoses (68 and 69) on firewall (71) with two hose clamps (70).
- c. Bend AC line bracket (229) to 45 degrees and connect AC line (76) to AC bracket and clamp (75) with bolt (73).
- d. Install AC line (76) on firewall (71) with clamp (74) and bolt (72).
- e. Check AC line (76) at the core support (14) for ample slack. If necessary carefully bend AC hard line downward to gain slack.

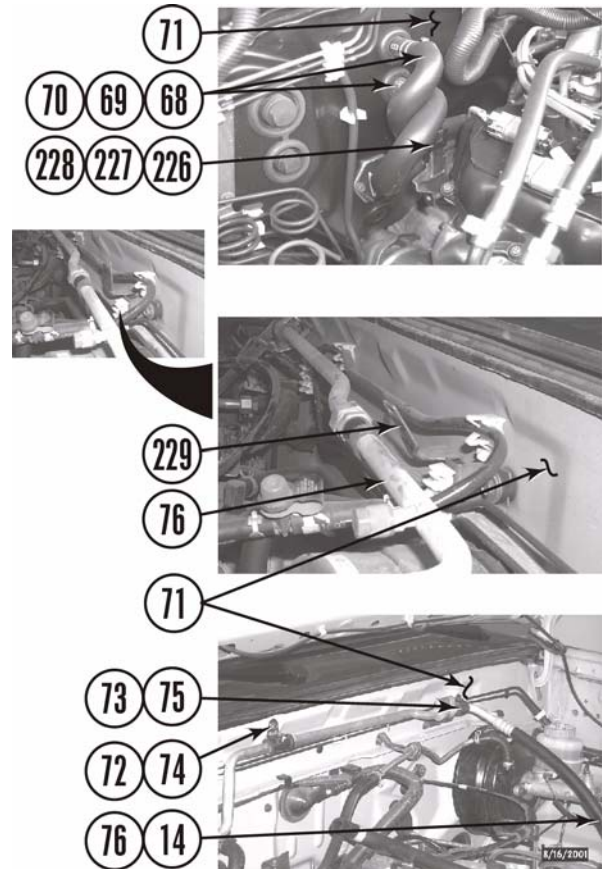

22. Radiator.

- a. Using *kit* lower radiator support bracket (230) as a template mark core support (14) with lines for cutting and dots for drilling as shown. Cut and drill core support where marked. Drill holes with a 1/4" drill bit.

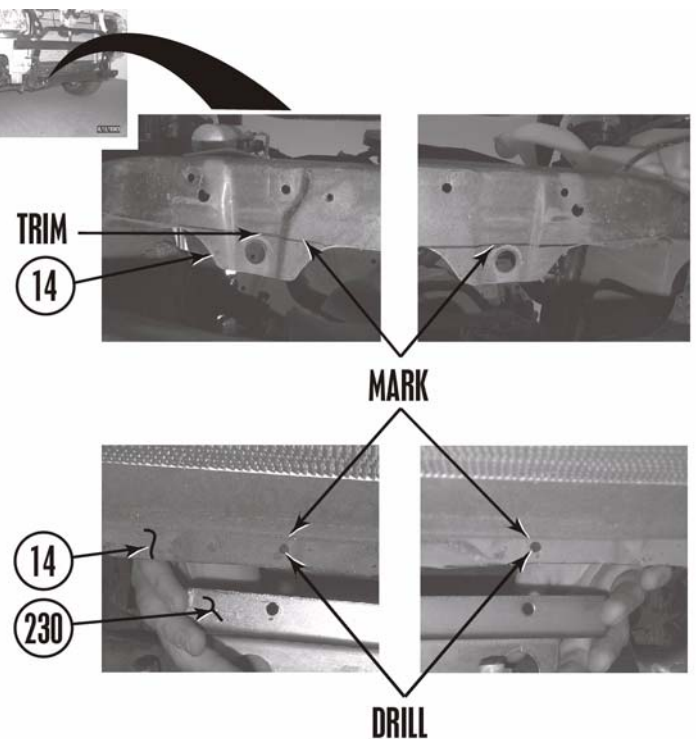

b. Install *kit* lower radiator support bracket (230) on core support (14) with two *kit* 1/4" x 1" bolts (216), four *kit* 1/4" washers (217), and two *kit* 1/4" nylock nuts (218).

c. Position radiator (47) and bushings (231) on *kit* lower radiator support bracket (230).

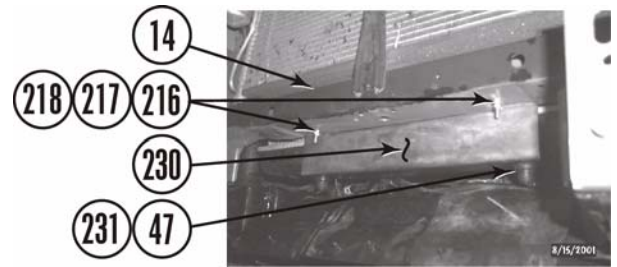

d. Remove two top radiator bushings (232) from two top radiator brackets (45 and 50).

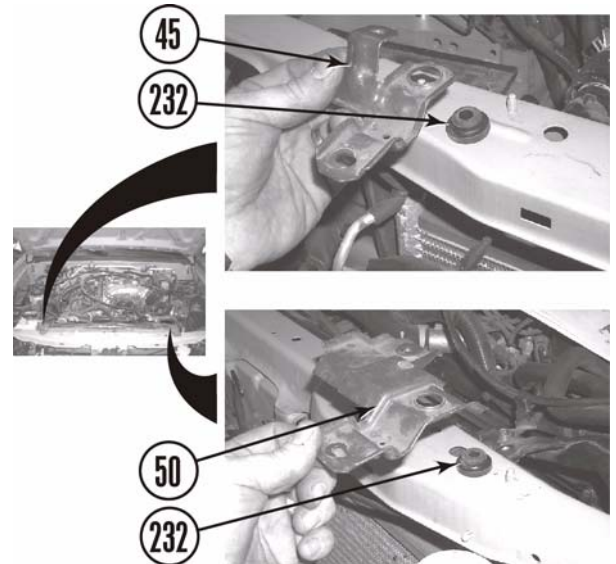

e. Install two top radiator bushings (232) on two *kit* 3" x 2" square brackets with holes (233).

f. Install two 3" x 2" square brackets with holes (233) and bushings (232) on radiator (47).

g. Install two top radiator brackets (45 and 50) on two *kit* 3" x 2" square brackets with holes (233) with two *kit* 3/8" x 1" bolts (234), four *kit* 3/8" USS washers (235), and two *kit* 3/8" nylock nuts (236).

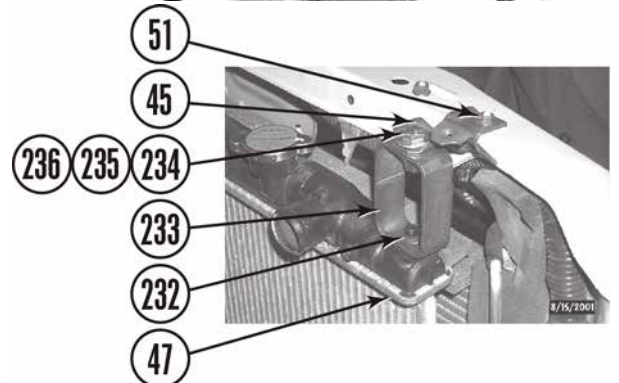

h. Install two top radiator brackets (45 and 50) on core support (14) with two nuts (51).

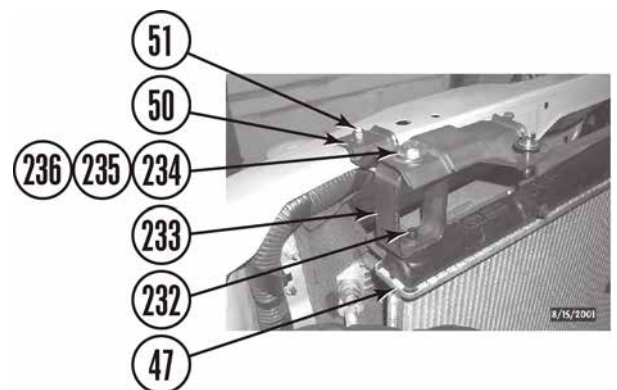

- i. Install two transmission cooler hoses (56 and 60) and lower radiator hose (58) on radiator (47) with three hose clamps (53 and 59).
- j. Test fit fan shroud (43) on radiator (47). Mark fan shroud for trimming. Trim fan shroud as shown.
- k. Install fan shroud (43) on radiator (47). Ensure two tabs (237) are positioned in lower radiator clips.
- l. Install transmission cooler hose (56) on two clips (57) and fan shroud (43).
- m. Install lower fan shroud cover (55) on fan shroud (43).

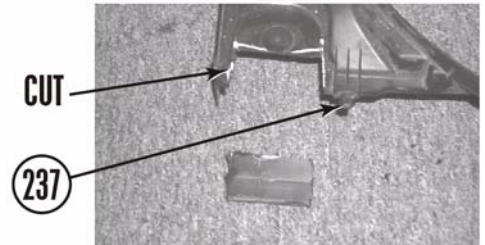
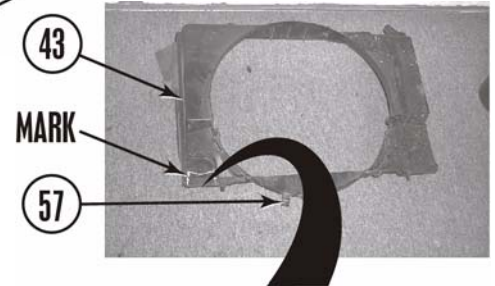
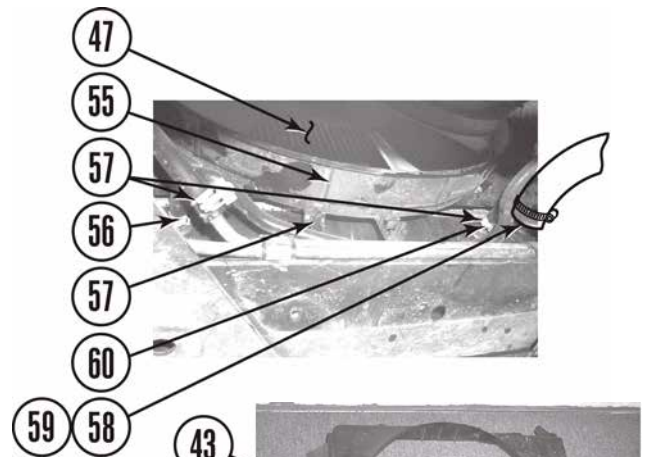

- n. Install fan shroud (43) on radiator (47) with two bolts (46).
- o. Install upper radiator hose (54) on radiator (47) with clamp (53).
- p. Install overflow bottle (41) on core support (14) and top radiator bracket (45) with tab (238) and two bolts (44).
- q. Install overflow hose (40) on fan shroud (43) and radiator (47) with two clamps (42).
- r. Install air tube (49) on bracket (50) with bolt with captive washer (48).

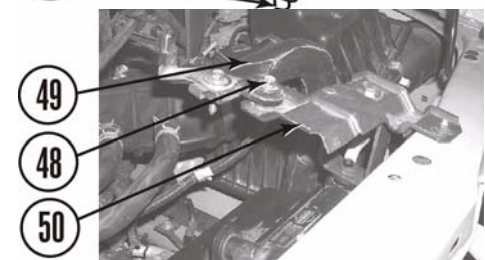
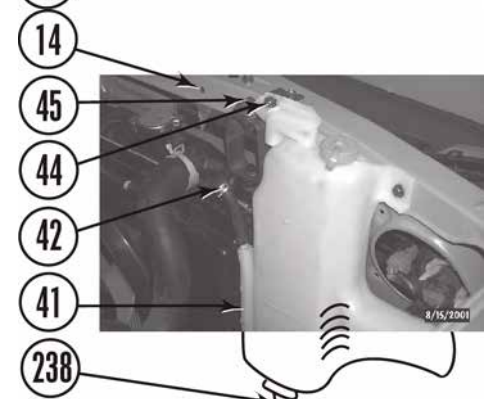
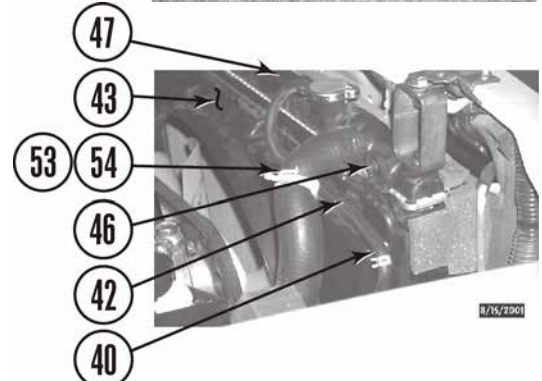

- s. Install front air flap (34) on core support (14) with six push clips (33).

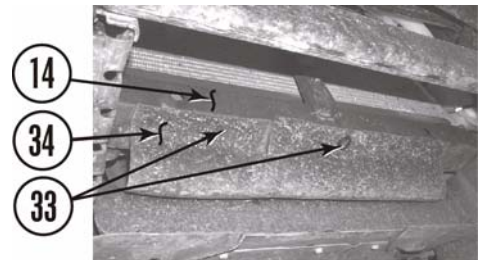

- t. Install two skid plate wings (37) and skid plate (38) on frame (20) and vehicle with two large push clips (36) and six bolts (35).

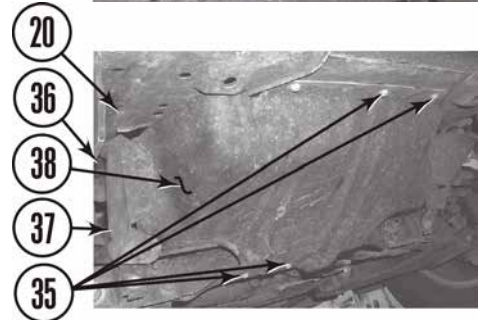

23. Kit steering extension.

- a. Position *kit* steering extension (239) on gear box (66). Be sure to line up flat spot on *kit* steering extension with flat spot on gear box splines so *kit* 3/8" socket head bolt (240) will slide through *kit* steering extension without force.
- b. Install *kit* 3/8" socket head bolt (240) in *kit* steering extension (239). Do not tighten.
- c. Align mark made in step B.2.b. and install steering shaft (64) on upper steering coupler (65) with bolt with captive washer (67). Do not tighten.
- d. Align mark made in step B.2.b. and install lower end of steering shaft (64) on *kit* steering extension (239) with bolt with captive washer (67).

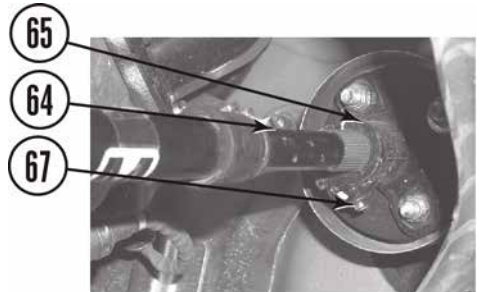
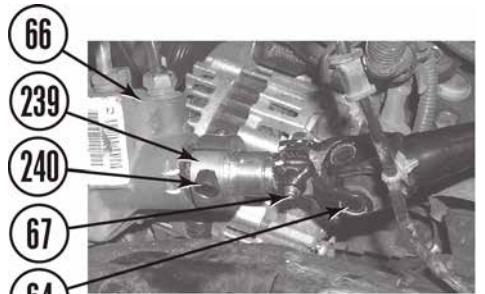

- e. Remove *kit* 3/8" socket head bolt (240) and two bolts with captive washers (67) one at a time. Coat threads with Loctite®, and reinstall. Tighten two bolts with captive washers and *kit* 3/8" socket head bolt to 22 lbs-ft.

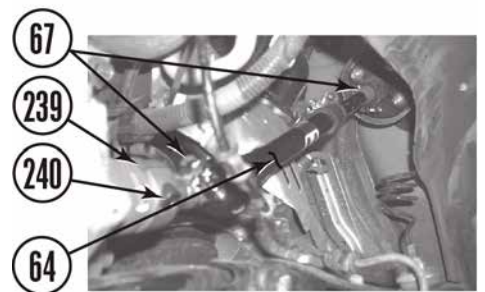

24. Air filter housing.

- a. Remove bolt with captive washer (241) from driver side wheel well (79) and bracket (242).

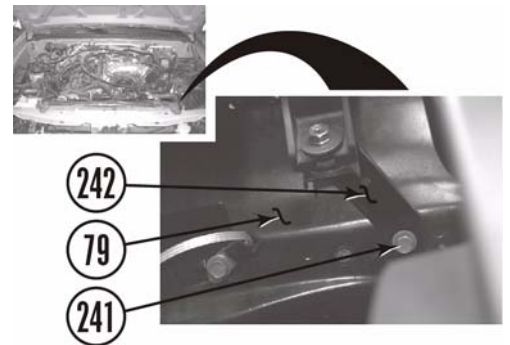

- b. Install four clamps (30) on air cleaner housing top (26), air filter (31), and lower air cleaner housing (32).

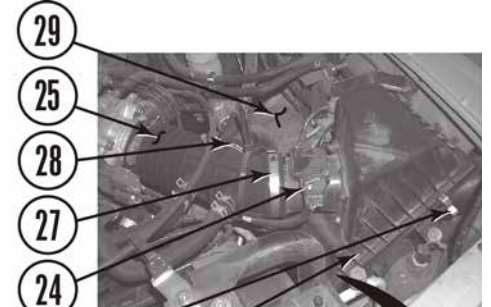

- c. Install air conduit (25) on air cleaner housing top (26) and air box (29) with two clamps (27 and 28).

- d. Install wiring harness clamp (24) on air cleaner housing top (26).

- e. Mark bracket (242) where it over laps hole. Remove bolt with captive washer (243) and bracket from lower air cleaner housing (32). Drill bracket where marked.

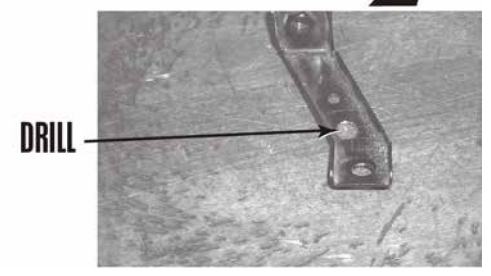
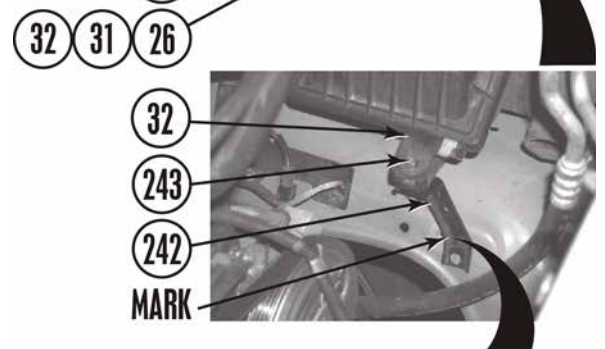

- f. Install bracket (242) on lower air cleaner housing (32) and driver side wheel well (79) with two bolts with captive washers (241 and 243).

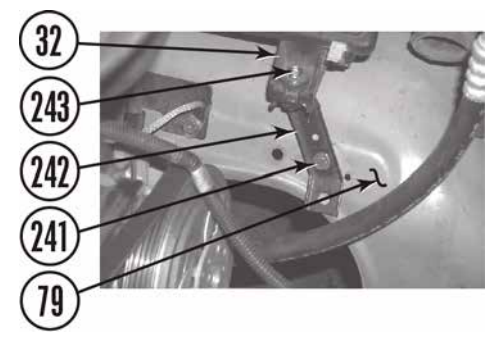

25. Front bumper.

- a. Install two *kit* front crush zone brackets (244) on frame (20) with two *kit* 7/16" USS washers (184) and two bolts (21). Position the lower "L" portion of the *kit* front crush zone bracket in frame as shown.
- b. Install two *kit* front outer bumper brackets (245) on frame (20) with four bolts with captive washers (21).
- c. Install lower bumper crush zone (22) on two *kit* front crush zone brackets (244) with two *kit* 7/16" x 1 1/2" bolts (246), four *kit* 7/16" USS washers (180), and two *kit* 7/16" nylock nuts (181).
- d. Install upper crush zone (11) on two *kit* front outer bumper brackets (245) with four *kit* 7/16" x 1" bolts (247), eight *kit* 7/16" USS washers (180), and four *kit* 7/16" nylock nuts (181).

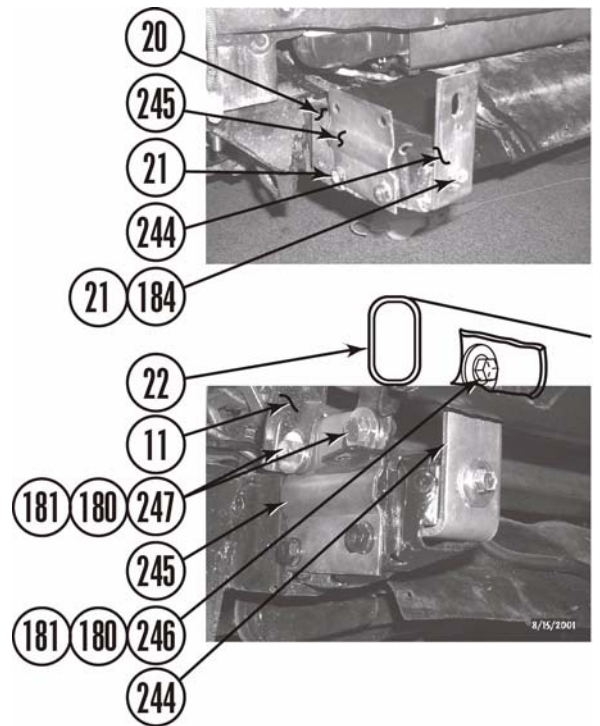

- e. Test fit front outer bumper (10) on vehicle. Mark where there is interference on frame (20). Trim front outer bumper where marked.

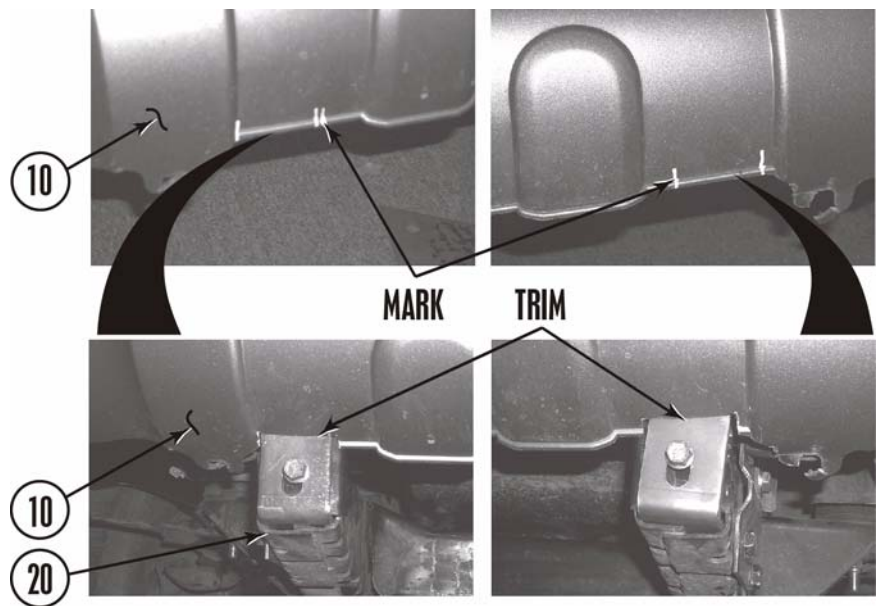

- f. Position front outer bumper (10) on vehicle and install on front fenders (17), lower crush zone (11), core support (14), and side front outer bumper brace (19) with four screws (9 and 16), six push clips (13), six plastic bolts (12) and four bolts (15 and 18).

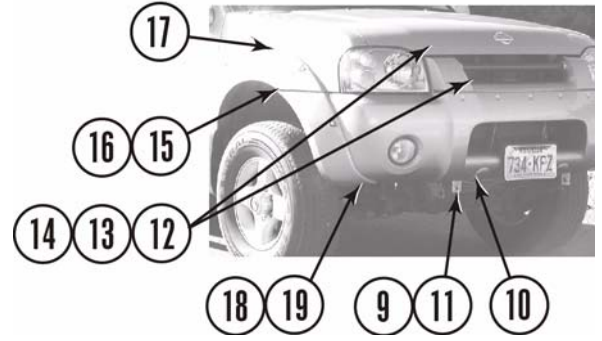

- g. Install two wiring harness connectors (7) on running lights (8).

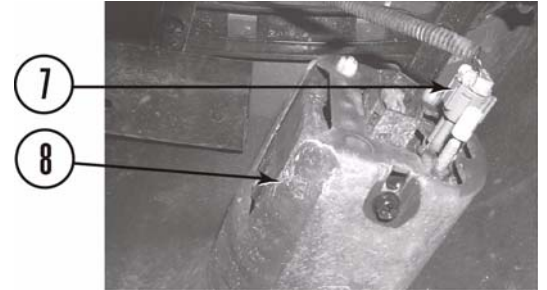

⚠WARNING

The following procedure is intended only to enhance the appearance of the vehicle. The rear bumper will no longer be rated for towing of any kind. Towing with the rear bumper after it has been lifted can result in death, serious personal injury, or damage to the vehicle. Towing after the bumper has been lifted should be accomplished using a rated Class III receiver type hitch.

26. Rear bumper.

- a. Install two *kit* rear bumper brackets (248) on frame (20), using the holes noted in step B.13.b., c., with two triple bolt fasteners (163) and six nuts (162). Do not tighten.
- b. Install rear bumper (160) on two *kit* rear bumper brackets (248) with two double bolt fasteners (166) and four nuts (165). Do not tighten.
- c. Adjust rear bumper (160) to bed (152) clearance using measurements from step B.13.a. Tighten nuts (165 and 162) to 55 lbs-ft.
- d. Install two license plate lights (161) on rear bumper (160).

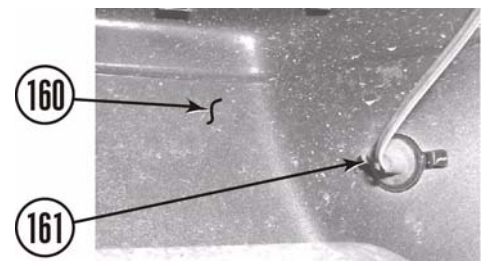
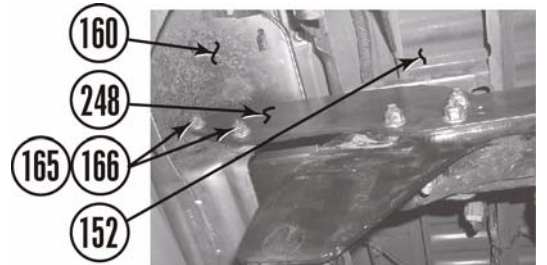
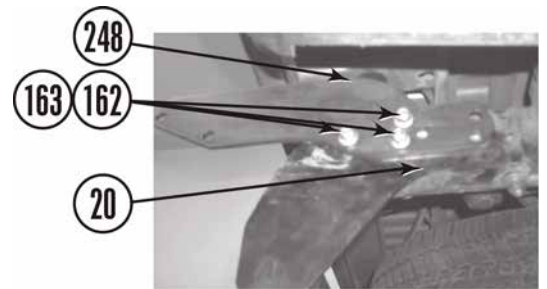

27. Crush blocks.

⚠WARNING

A certified welder should perform all welding.

- a. Remove eight screws (249) and four rubber bumpers (250) from frame (20).

- b. Position four *kit* crush blocks (251) on frame (20) under bed (152).

- c. Weld four *kit* crush blocks (251) on frame (20) as shown.



D. After installation is complete.

1. Install airbag fuse (5) in fuse panel (6). Install cover (4).
2. Connect both battery cables to the battery (3). Be sure to reconnect the positive cable (2) first, then the negative cable (1).
3. Stick *kit* warning sticker on the dash in plain sight of all vehicle occupants.

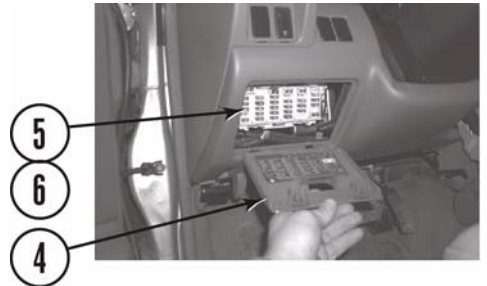

4. Double check the vehicle.

⚠CAUTION

Re torque all fasteners after 500 miles and after off road use. All body lift components should be visually inspected and fasteners re torqued during routine vehicle servicing.

- a. Check all mounting hardware to ensure it is properly tightened.
- b. Check all wires, hoses, cables, etc. to ensure they have been properly connected and there is ample slack. With the number of hoses on this vehicle, it is vital that this be checked thoroughly.
- c. Check vehicle electrical system.
- d. Start vehicle and check the steering in both directions to ensure that there is no bind. Check clutch operation. Check the operation of the brake system and the parking brake. Check both shift levers' operation. Ensure that there is proper engagement in all gears and 4 wheel drive ranges.
- e. Test drive vehicle in all gears and 4 wheel drive ranges. Pay close attention to all vehicle systems. Check all hardware again in 500 miles and as part of your regular maintenance schedule.

⚠CAUTION

Performance Accessories does not recommend any particular wheel and tire combinations for use with its body lifts and cannot assume responsibility for the customer's choice of wheels and tires. Reference your owner's manual for recommended tire sizes and warnings related to the use of oversized tires. Larger wheel and tire combinations increase stress and wear on steering and suspension components, which leads to increased maintenance and higher risk for component failure. Larger wheel and tire combinations also alter speedometer calibration, braking effectiveness, center of gravity, and handling characteristics. Consult with an experienced local off road shop to find what wheel and tire combinations work best with your vehicle.

⚠NOTE

All warranty information, instruction sheets, and other documents regarding the installation of this product must be retained by the vehicle owner. Information contained in the instructions and on the warranty card will be required for any warranty claims. The vehicle owner needs to understand the modifications made to his vehicle and how they affect vehicle handling and performance. Failure to provide the customer with this information can result in damage to the vehicle and severe personal injury.

E. Kit Parts List. KIT PA40043

Quantity	Description
8	3" x 3" blocks
4	3" x 2" blocks
2	Front crush zone brkts. 2wd & 4wd std., ext., and crew cab. (40033-1)
2	Front outer bumper brackets 2wd & 4wd std., ext., and crew cab.
2	Rear bumper brackets 2wd & 4wd std., ext., and crew cab. (40033-3)
1	Fuel filler extension (UP3-19)
2	1/4" x 11" vent hose tubing
1	Power steering reservoir 2wd & 4wd std., ext., & crew cab Z-bracket (4083-6)
1	Power steering reservoir crew cab, ext., & crew cab C-bracket
1	Lower radiator support bracket
1	Manual trans. shift lever ext SE 9500
4	2" x 3" Spacers without holes bed support (UP3-15)
2	2" x 3" Spacers with holes radiator support (UP3-2)
2	2" x 3" x 2 3/8" Bed spacer blocks with holes (2003-1)
2	Cab body bracket 4wd (4073-4)
1	Warning to driver sticker
1	Logo sticker
1	6ml bottle Loctite

1 Bolt pack BP40043

Bolts	
2	10mm x 190mm bolts
2	12mm x 210mm bolts
4	7/16" x 7" bolts
2	1/2" x 5" bolts
2	1/2" x 5 1/2" bolts
1	3/8" x 1 1/4" socket bolt
Washers	
10	7/16" USS washers
10	1/2" USS washers
Nuts	
4	7/16" nylock nuts
4	1/2" nylock nuts
Miscellaneous	
1	SE 9000 steering ext.

Quantity	Description
1	Hardware pack HP40043
Bolts	
2	10mm x 1.5 x 100mm bolts
4	7/16" x 1" bolts
4	7/16" x 1 1/2" bolts
11	1/4" x 1" bolts
2	3/8" x 1" bolts
4	5/16" x 1" bolts
Washers	
20	7/16" USS washers
24	1/4" SAE washers
6	3/8" USS washers
8	5/16" USS washers
Nuts	
8	7/16" nylock nuts
13	1/4" nylock nuts
2	3/8" nylock nuts
4	5/16" nylock nuts
Miscellaneous	
2	3/8" x 3" scd. 40 safety tubes (40003)
5	Zip ties
2	3" radiator brackets for brake lines pas-side wheel well.
2	#28 hose clamps
1	4wd shift lever extension.
1	3" L-bracket.

Accessories

Gap Guards: Kit# PA6420 Front and Rear

