



3651 N Highway 89 • Chino Valley, AZ 86323  
(928) 636-7080

# TOYOTA TACOMA 2WD & 4WD 3" KIT

## INSTALLATION INSTRUCTIONS

**2001-2002**

**KIT# 5583**

**2003-2004**

**KIT# 5593**

### ⚠ WARNING

Installation of a Performance Automotive Group body lift kit will change the vehicle's center of gravity and handling characteristics both on- and off-road. You must drive the vehicle safely! Extreme care must be taken to prevent vehicle rollover or loss of control, which could result in serious injury or death. Avoid sudden sharp turns or abrupt maneuvers and always make sure all vehicle occupants have their seat belts fastened.

### ⚠ WARNING

Before you install this kit, read and understand all instructions, warnings, cautions, and notes in this instruction sheet and in the vehicle owner's manual.

### ⚠ CAUTION

Proper installation of this kit requires knowledge of the factory recommended procedures for removal and installation of original equipment components. We recommend that the factory shop manual and any special tools needed to service your vehicle be on hand during the installation. Installation of this kit without proper knowledge of the factory recommended procedures may affect the performance of these components and the safety of the vehicle. We strongly recommend that a certified mechanic familiar with the installation of similar components install this kit.

### ⚠ WARNING

DO NOT combine suspension, body, or other lift devices. Use of vehicle with combined lifts may result in unsafe and/or unexpected handling characteristics.

### ⚠ WARNING

This kit should only be installed on a vehicle that is in good working condition. Before you install the kit, thoroughly inspect the vehicle for corrosion or deformation of the sheet metal around the factory body mounts. If the vehicle is suspected to have been in a collision or misused, do not install this kit. Off-road use of your vehicle with this kit installed may increase the stress applied to the factory body mounts. We do not recommend that any vehicle with a body lift kit installed be involved in any extreme off-road maneuvers such as jumping. Failure to observe this warning may result in serious personal injury and/or severe damage to your vehicle.

### ⚠ WARNING

Many states and municipalities have laws restricting bumper heights and vehicle lifts. Consult state and local laws to determine if the changes you intend to make to the vehicle comply with the law.

### ⚠ WARNING

The installation of larger tires may reduce the effectiveness of the braking system.

### ⚠ WARNING

Always wear eye protection when operating power tools.

### ⚠ WARNING

Before you install this kit, block the vehicle tires to prevent the vehicle from rolling.

### ⚠ WARNING

Accidental deployment of the air bag can result in serious personal injury or death. To avoid accidental deployment during installation of the kit, the Supplemental Restraint System (SRS, or airbag) must remain deactivated. Do not allow anyone near the airbag during installation. Refer to the factory service manual or owner's manual for the recommended procedure to disable the SRS. After you install the kit, reactivate the SRS before driving the vehicle.

### NOTE

Performance Automotive Group recommends using the Loctite® supplied in the kit on the threads of all kit nuts and bolts unless specified otherwise in these instructions.

# Before Starting Installation

**NOTE**  
Kit parts are prefaced by the word *kit* and appear in **bold** print.

1. Carefully read all warnings and instructions completely before beginning.
2. Verify all parts have been received in this kit by checking the parts list at the end of this document.

**NOTE**  
If parts are missing from kit, please be prepared to provide the following information:  
1. **Name** of purchase location  
2. **Bar Code** on side of box  
3. **Date** above bar code  
4. **Date** inside box cover  
5. **Inspector #** from inside box cover

3. **Only install this kit on the vehicle for which it is specified.** If anytime during the installation you encounter something different from what is outlined in the instructions, call technical support at (928) 636-7080.
4. Special tools needed:
  - a. Welder or access to a professional welding shop.
  - b. Die grinder or similar tool capable of cutting metal.
5. Park vehicle on a clean, dry, flat, level surface and block tires so vehicle cannot roll in either direction.

# Engine Compartment

1. Disconnect both battery cables. Disconnect negative cable first, then positive cable.

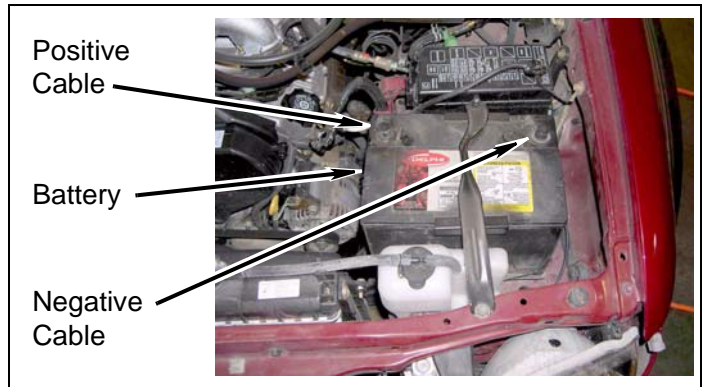

2. Airbag Fuse

**NOTE**  
The location of the airbag fuse may vary; check the owner's manual.

- a. Remove airbag fuse.

# Prepare to Install Kit

## Measurements

1. Measure and record distance between front bumper and fenders.  
Driver Side \_\_\_\_\_ Passenger Side \_\_\_\_\_
2. Measure and record distance between rear bumper and bed  
Driver Side \_\_\_\_\_ Passenger Side \_\_\_\_\_
3. Measure and record distance between cab and bed.  
Driver Side \_\_\_\_\_ Passenger Side \_\_\_\_\_

## Front of Vehicle

### 1. Front Bumper

- a. If equipped, remove two fog light wiring connectors from two fog lights.

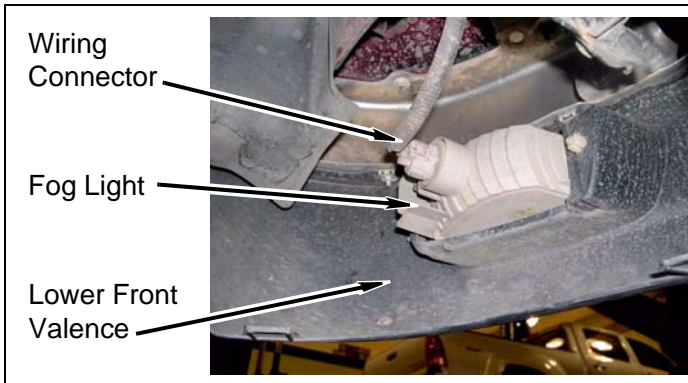

- b. Remove two push clips from lower front valence and crush zone.

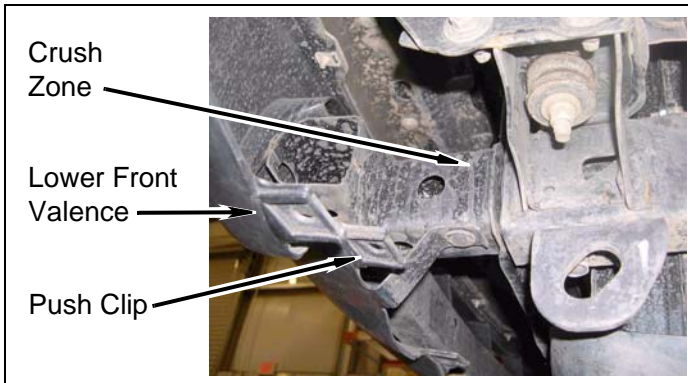

- c. Remove two nuts from driver and passenger front fenders.

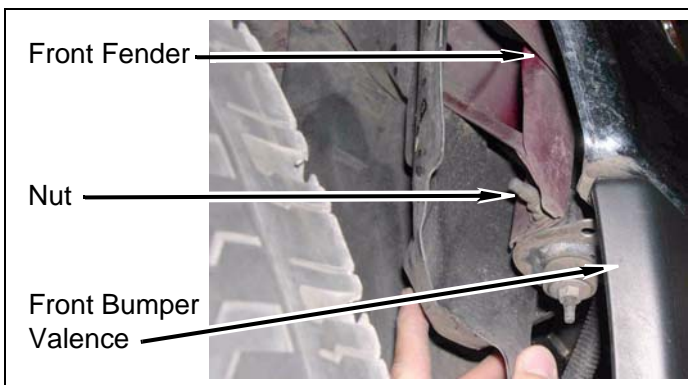

- d. Remove four bolts and front bumper valence from vehicle.

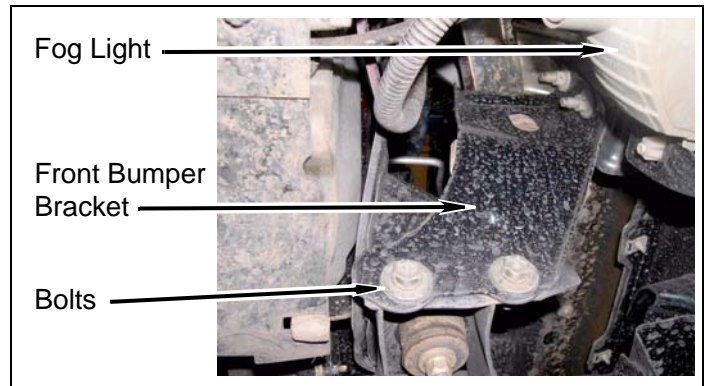

- e. Remove four nuts and front bumper from crush zone.

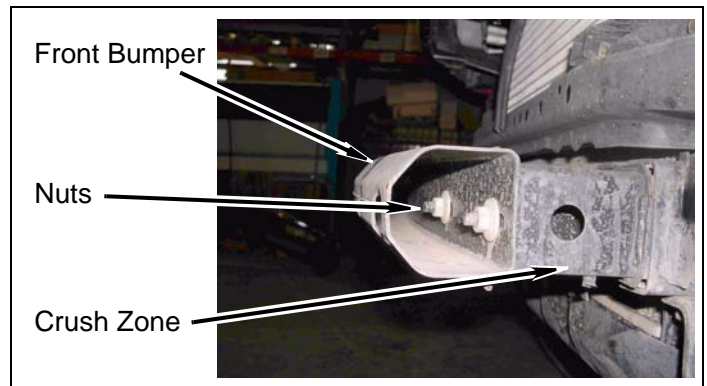

- f. Remove three bolts from skid plate and crush zone.

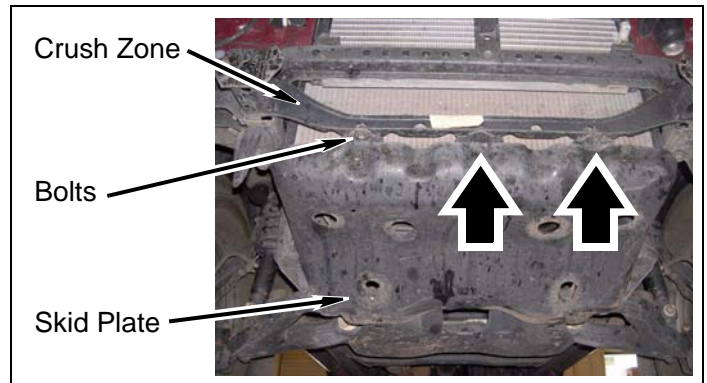

- g. If equipped, remove two bolts, four brackets, and oil cooler from core support and crush zone. Allow oil cooler to hang on hoses.

- b. Release nine clips and remove two turn signal connectors. Remove grill from vehicle.

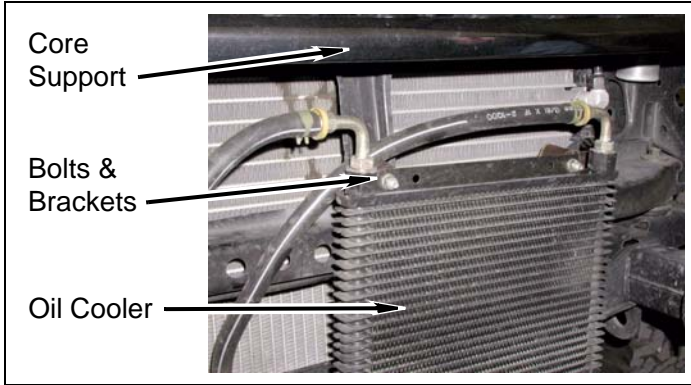

- h. Remove two bolts and crush zone from frame.

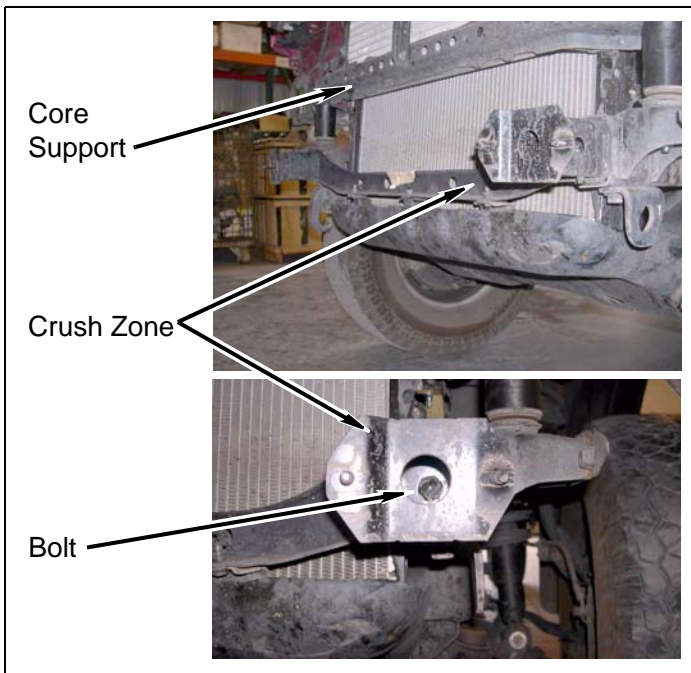

2. Grill

- a. Remove two screws from grill and core support.

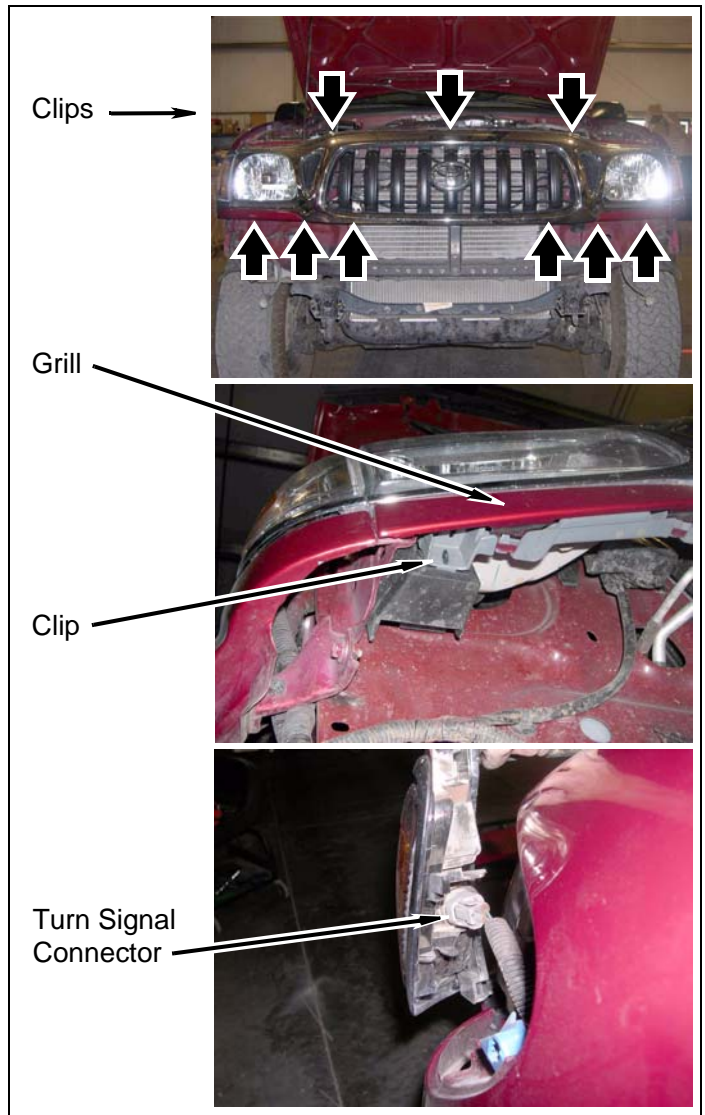
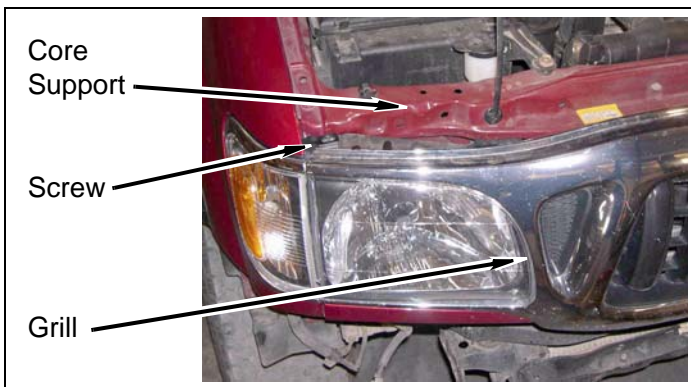

Engine Compartment

- 1. Loosen clamp and remove air intake hose from airbox.

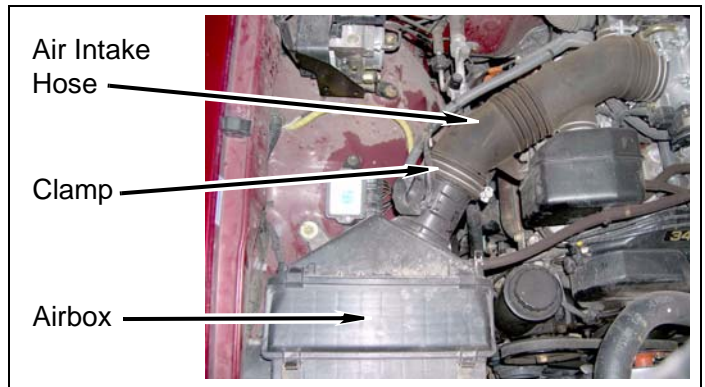

2. Remove nut, bolt, battery tie down, and battery from vehicle.

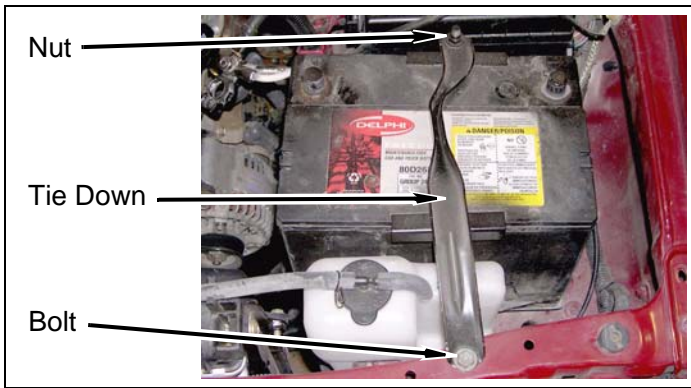

6. Disconnect overflow hose from overflow reservoir and remove overflow reservoir from core support.

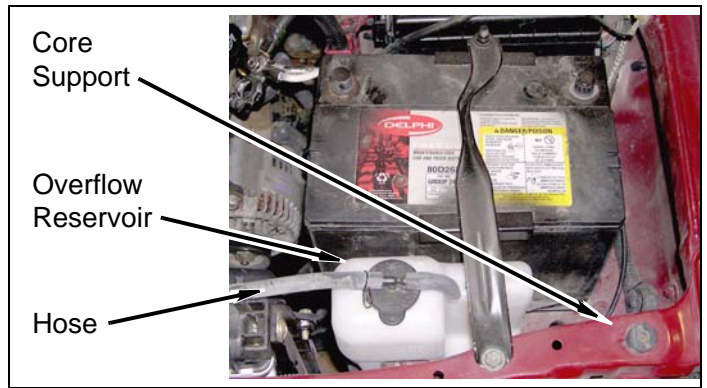

3. Remove two bolts and positive battery cable from driver side front wheel well and frame.

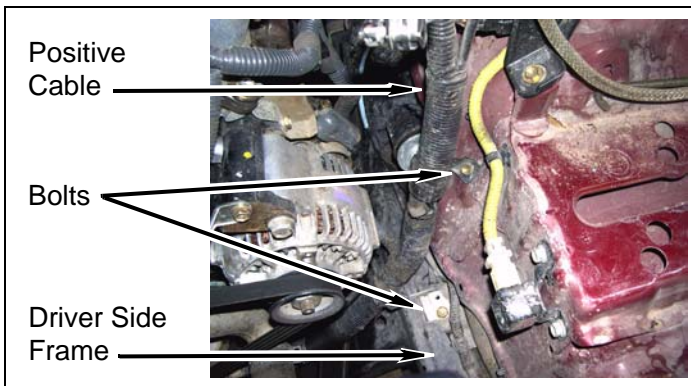

7. Remove four bolts and radiator from core support. Allow radiator and fan shroud to rest on fan.

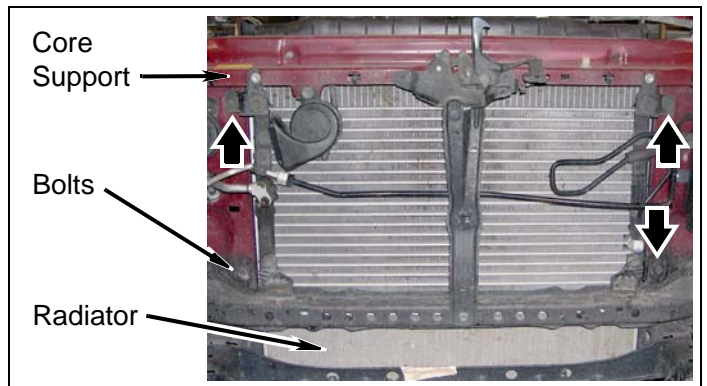

4. Remove vacuum line from two driver side clips.

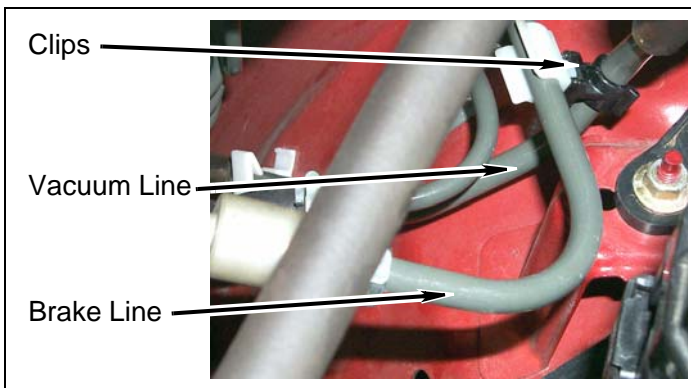

8. Bend two radiator locating tabs outward.

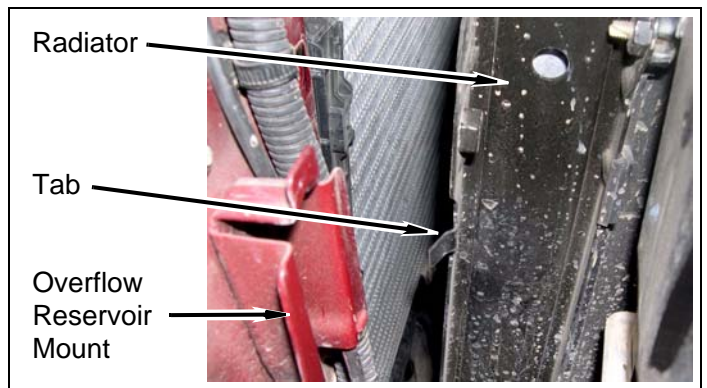

5. **4WD Models:** Remove two axle vent lines and clip from driver side wheel well.

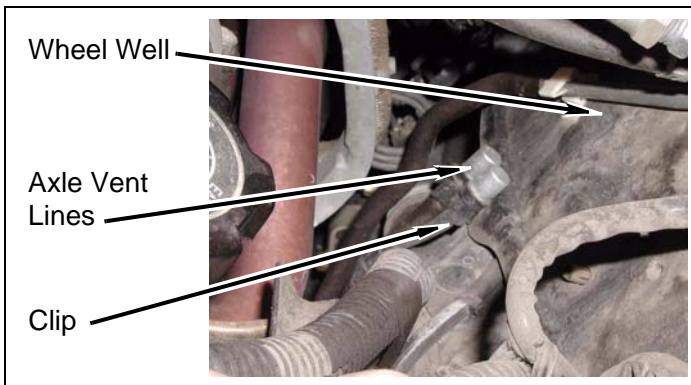

9. Remove wiring harness clip from passenger side firewall bracket.

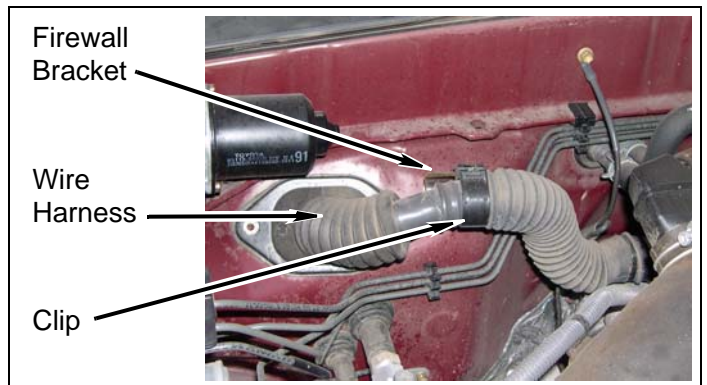

10. Remove tape and extend passenger side firewall ground wire.

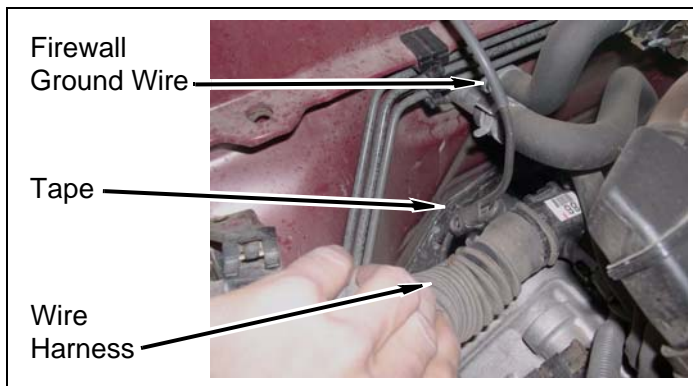

11. Steering Shaft

**⚠ WARNING**  
 Accidental deployment of the air bag can result in serious personal injury or death. To avoid accidental deployment during installation of the lift kit, the Supplemental Restraint System (SRS, or airbag) must remain deactivated. Do not allow anyone near the airbag during installation. Refer to the factory service manual or owner's manual for the recommended procedure to disable the SRS. After kit installation, the SRS must be reactivated before driving the vehicle.

**⚠ CAUTION**  
 If the following step is not performed, the airbag clockspring could be damaged. Do not turn the steering wheel while the steering shaft is disconnected.

- a. Strap steering wheel to prevent accidental movement.
- b. Mark lower steering shaft and rag joint in relation to rack and pinion as shown.

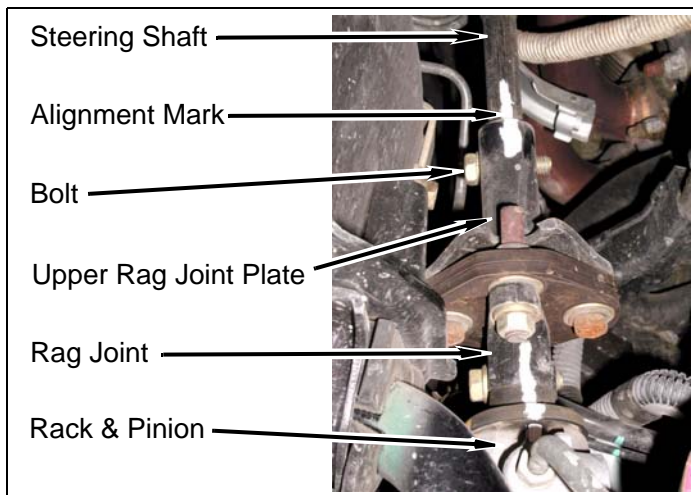

c. Remove bolt and slide steering shaft up off rag joint.

**NOTE**  
 Remove ONLY upper rag joint plate bolt. Lower rag joint and bolt are NOT removed.

**Underside of Vehicle**

1. Wheel wells
  - a. Remove two nuts and bracket from driver side front wheel well.

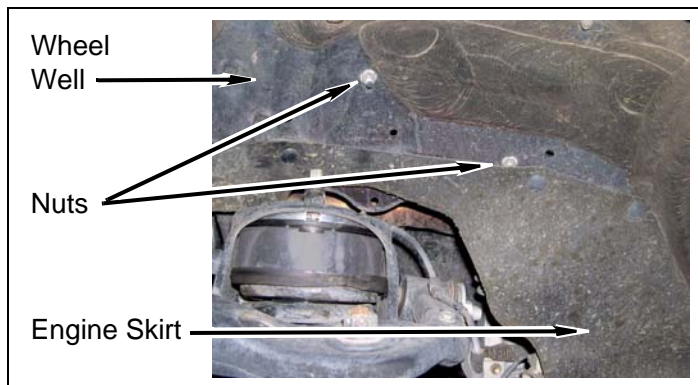

b. Remove push clips and three engine skirts from driver and passenger side front wheel wells.

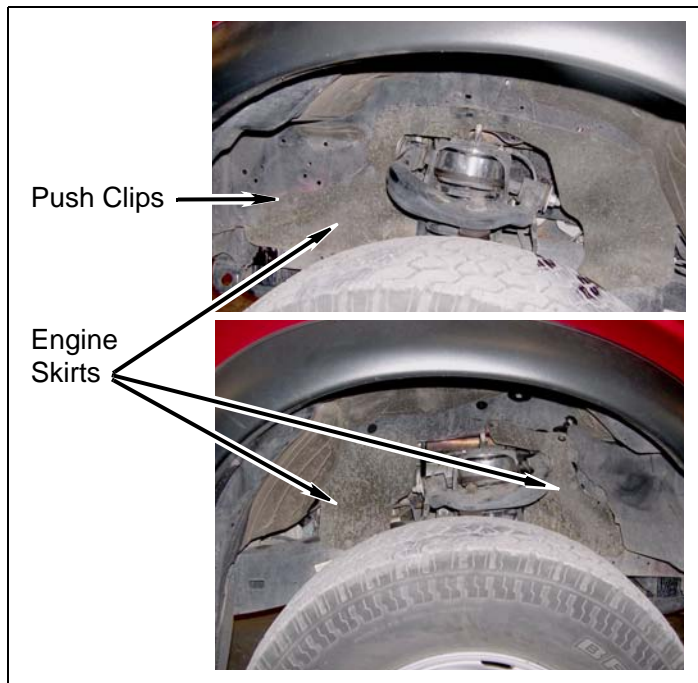

- Remove bolt, bracket, and wiring harness from passenger side front frame.

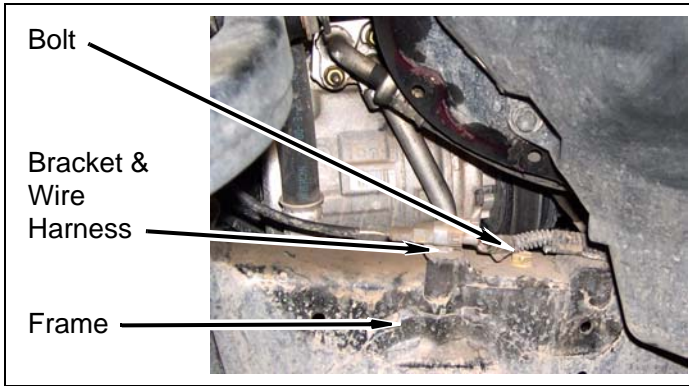

- Remove clip and parking brake cable from driver side frame bracket.

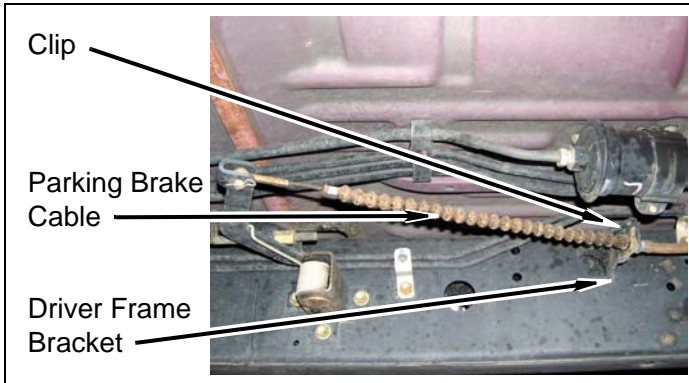

- Automatic Transmission Models:** Mark automatic transmission shift lever in relation to shift linkage. Remove cotter key and pin (or nut) from transmission shift linkage and automatic transmission shift lever.

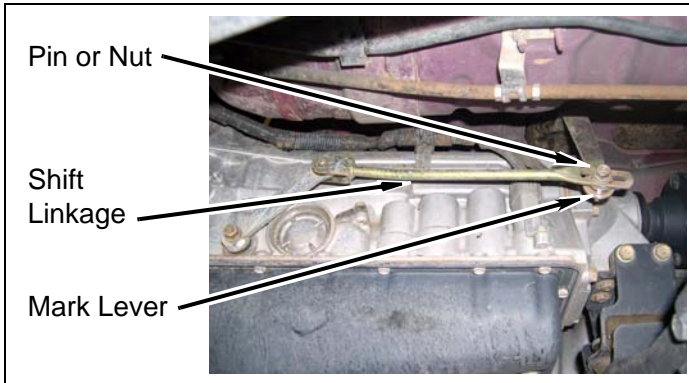

## Inside of Vehicle

- Manual transmission

- Remove transmission and transfer case shift knobs from transmission shift lever and transfer case shift lever.

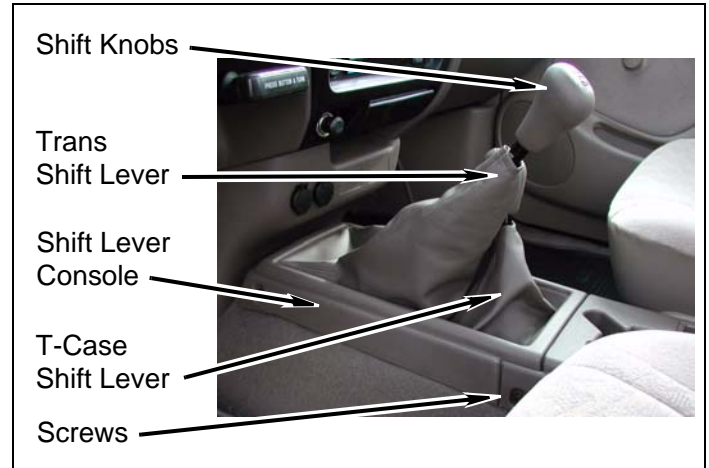

- Remove four bolts, two screws, and rear center console from shift lever console and vehicle.

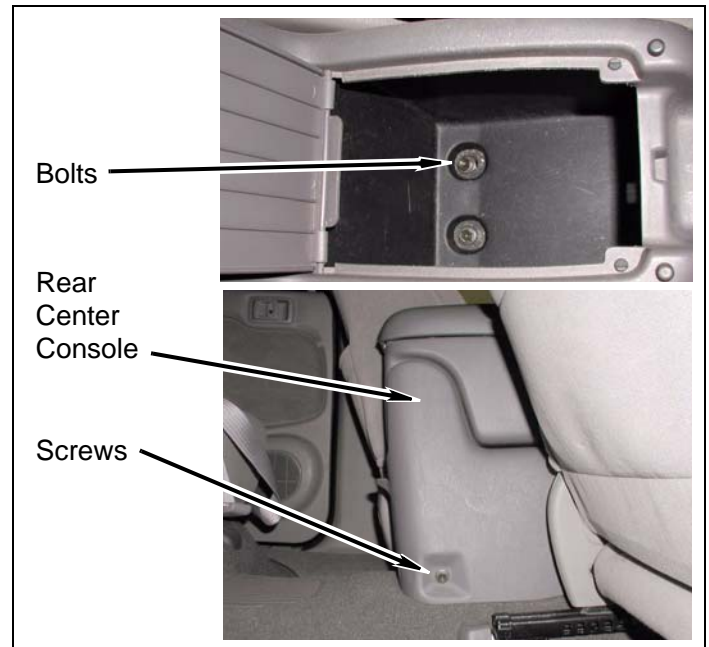

- c. Remove two screws, shift lever console, and outer transmission shift lever boot from vehicle.

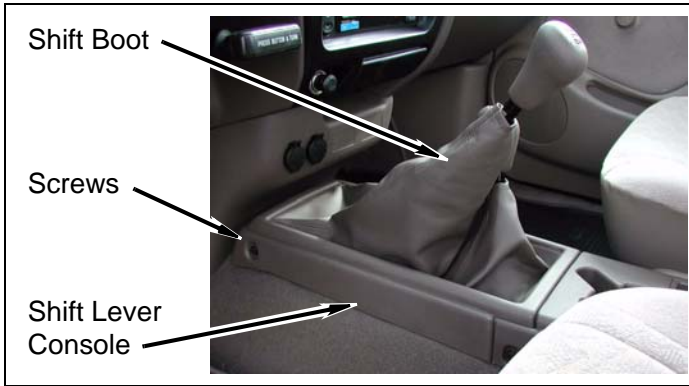

- d. Remove four bolts, adapter plate, and intermediate shift boot from vehicle.



- e. Lift lower transmission shift lever boot and press locking collar down around transmission shift lever. Turn locking collar counterclockwise and remove transmission shift lever, lower boot, locking collar, and spring from transmission.

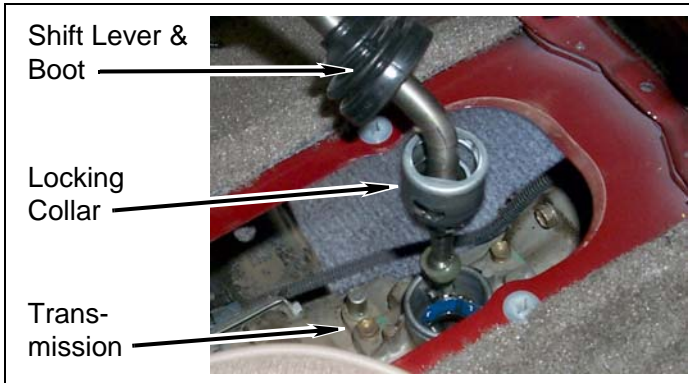

- f. Cover transmission holes with shop rags or towels.

2. Automatic transmission

- a. If equipped, remove screw and transfer case shift knob from transfer case shift lever. Allow shift knob to rest on console.

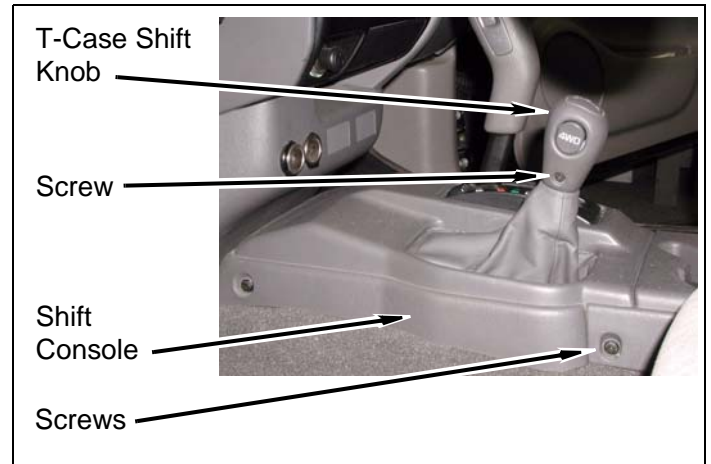

- b. Remove four bolts, two screws, and rear center console from shift lever console and vehicle.

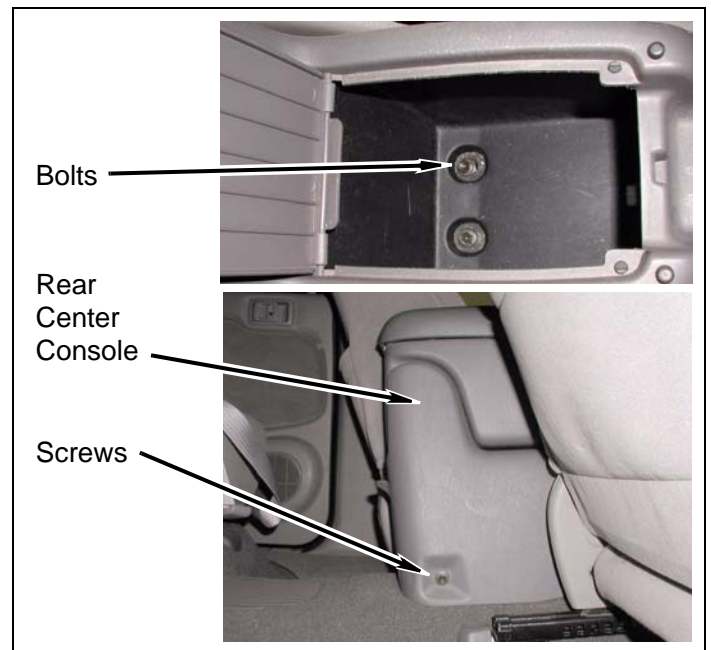

- c. Remove two screws from shift lever console.

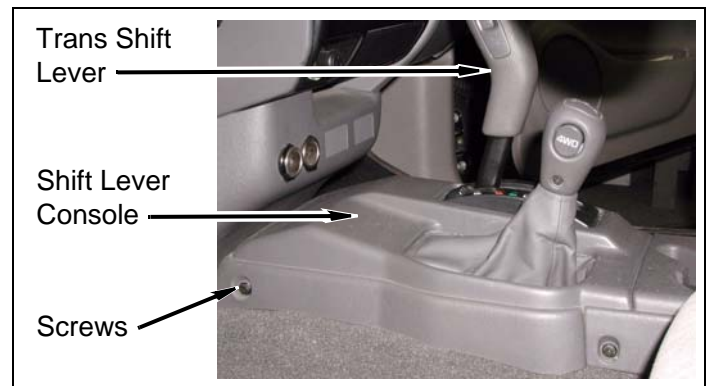



- d. Lift shift lever console and disconnect transfer case shift knob wiring harness.

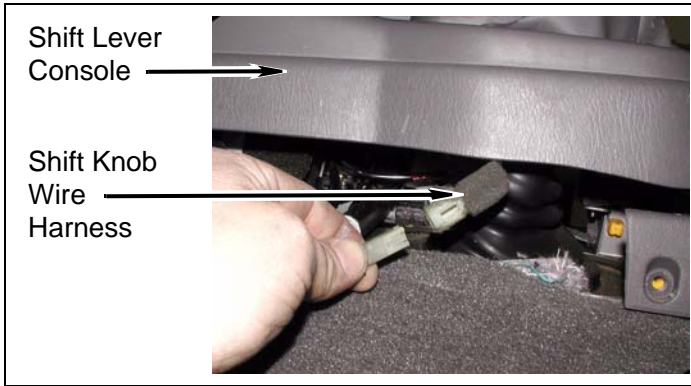

- e. Remove shift lever console and transfer case shift lever boot from vehicle.
- f. Disconnect transmission wiring harness from connector.

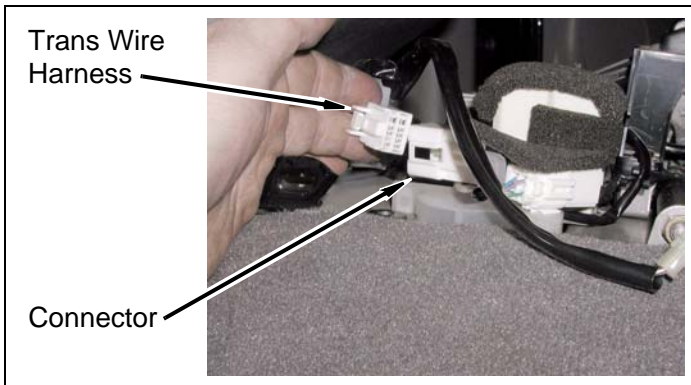

- g. Remove eight bolts, adapter plate, intermediate shift boot, and transmission shifter from vehicle.

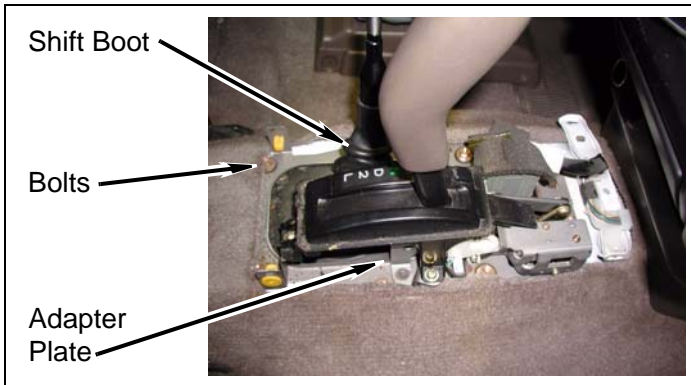

### 3. Manual transfer case

- a. Lift lower transfer case shift lever boot from transfer case.

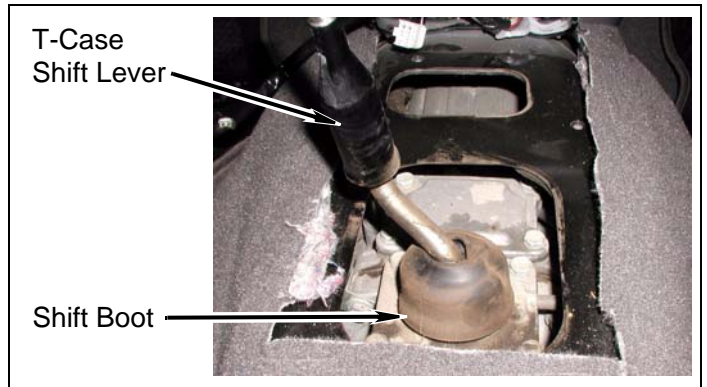

- b. Remove C-clip and transfer case shift lever, lower boot, two covers, and spring from transfer case.

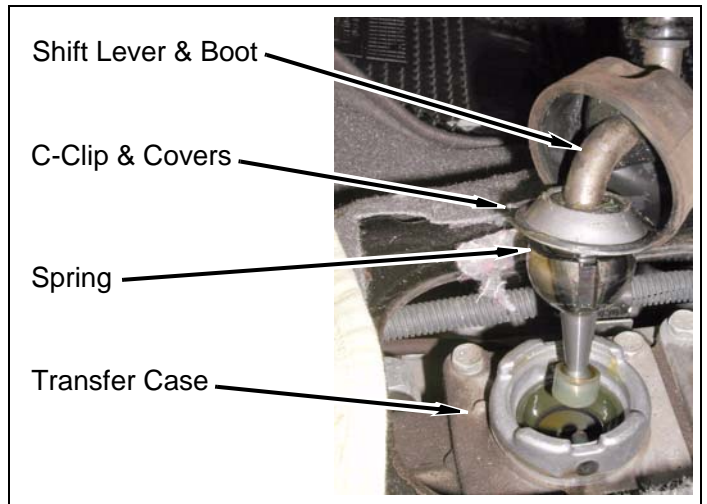

- c. Cover transmission and transfer case holes with shop rags or towels.

### 4. Front interior

- a. Remove eight screws and two scuff plates from driver and passenger side door jambs.

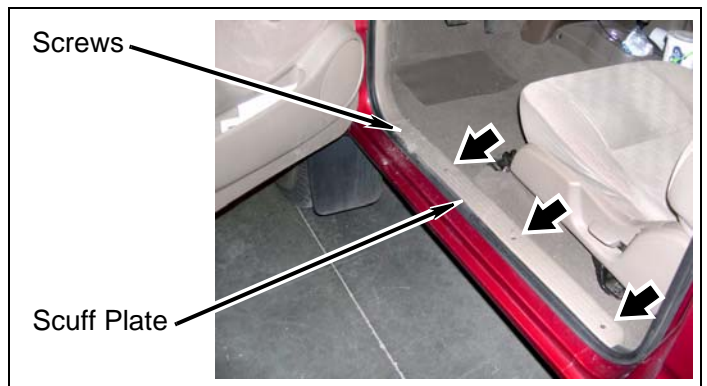

- b. Pull back and remove driver and passenger side kick panels.

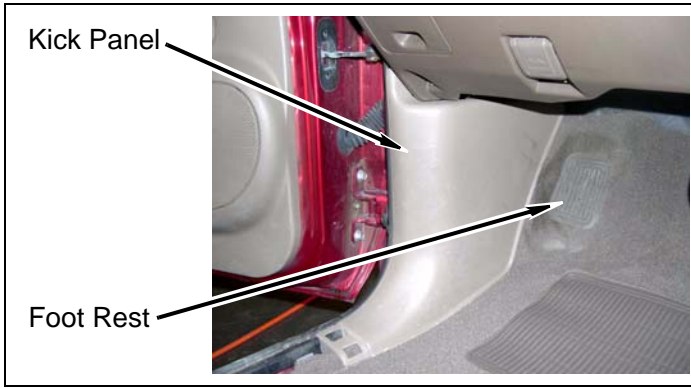

- c. Pull up carpet from beneath driver and passenger kick panels and remove two plastic access covers from floor.

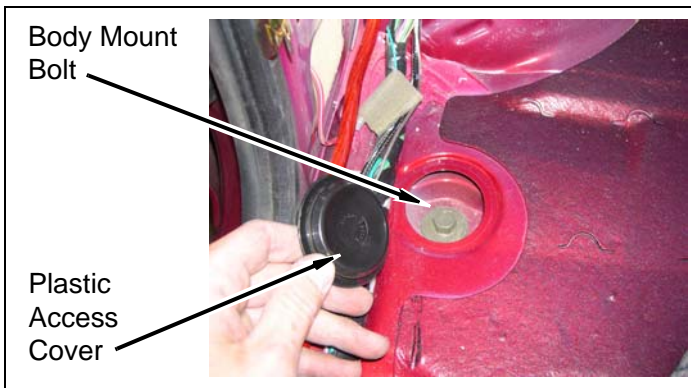

5. Rear interior

- a. **Extended & Crew Cab Models:** Fold up rear seat bottoms and remove two floor storage covers from floor.

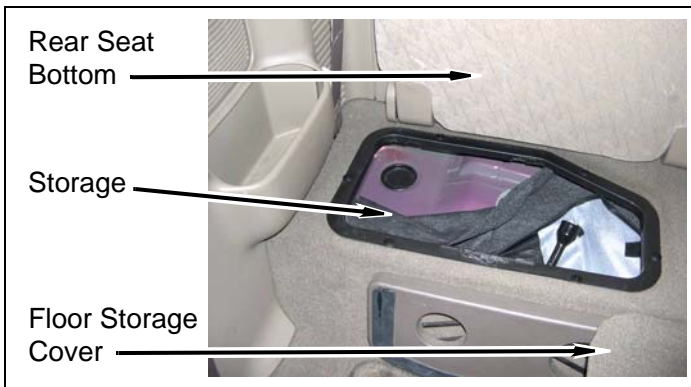

- b. Pull up rear driver and passenger corner carpet and remove two plastic access covers from floor.

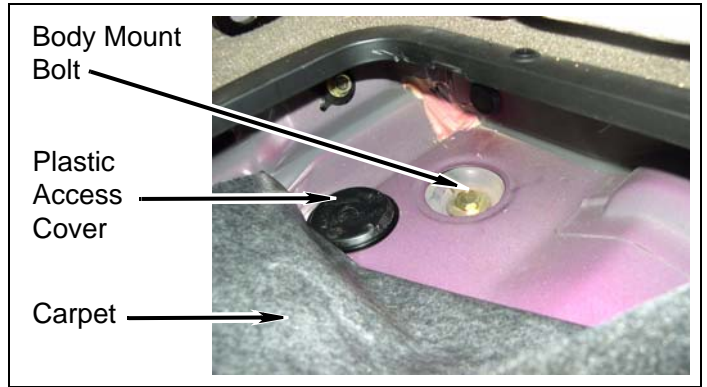

Rear of Vehicle

1. Fuel filler

- a. Remove fuel cap, four screws, and filler surround from vehicle.

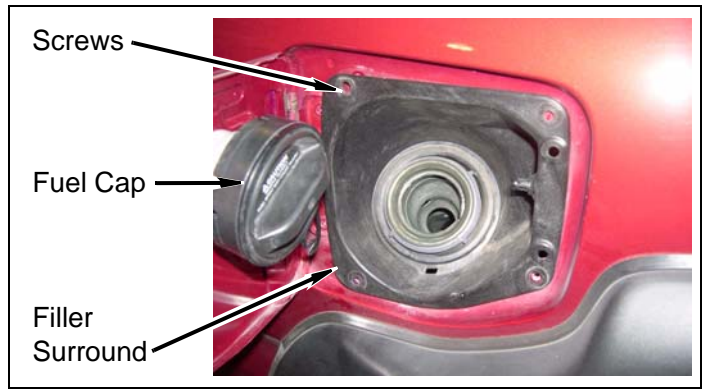

2. Rear bumper

- a. If equipped, remove two bolts and trailer hitch wire harness bracket from rear bumper.

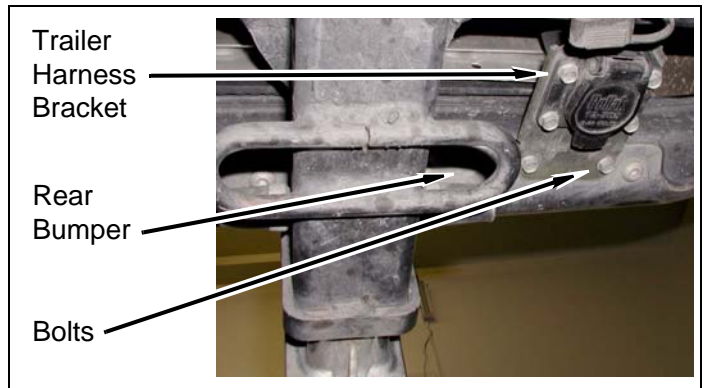

- b. Remove two license plate light wire harness connectors from rear bumper.

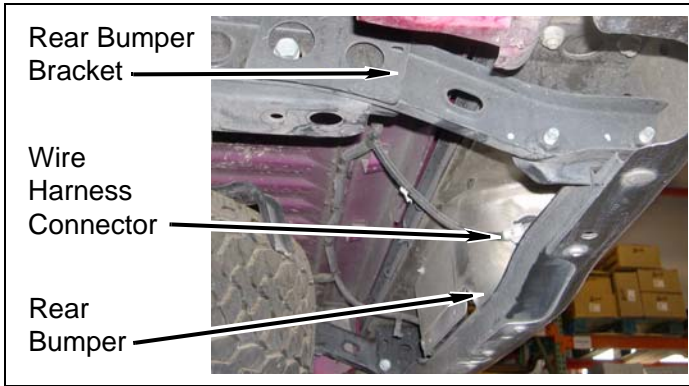

- c. Remove four bolts, two nuts, two rear bumper brackets, and rear bumper from vehicle.

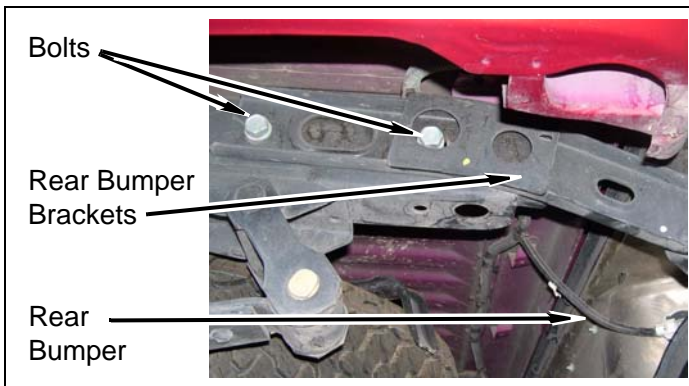

# Install Kit

## Cab

1. Prepare to lift cab from frame

- a. Loosen, but DO NOT REMOVE, cab mounting bolts on driver side.

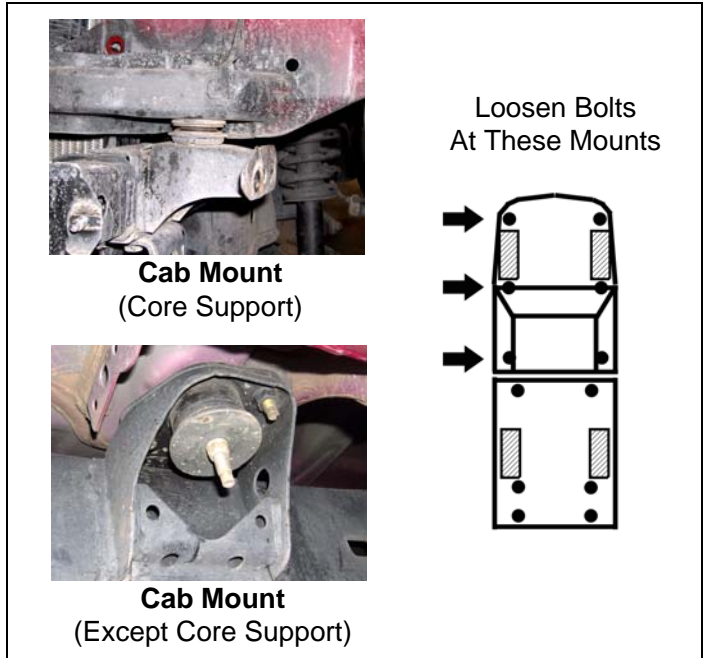

### NOTE

The number of cab mounting bolts may vary with the length of the cab.

- b. Remove nut, washer, and bolt from each cab mount on passenger side.

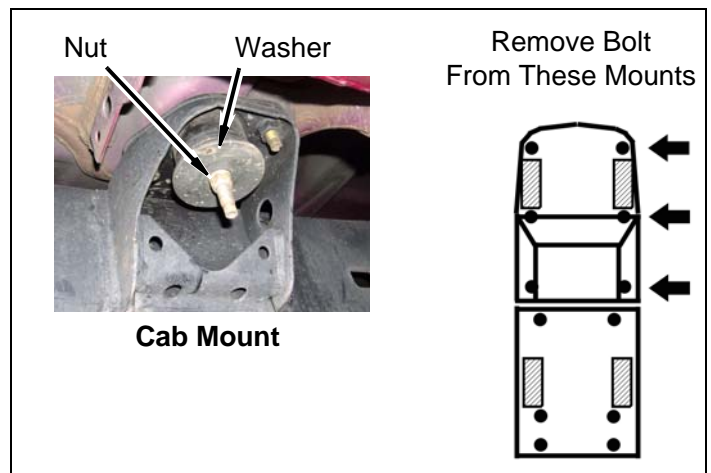

- c. Remove captive washer from each cab mounting bolt.

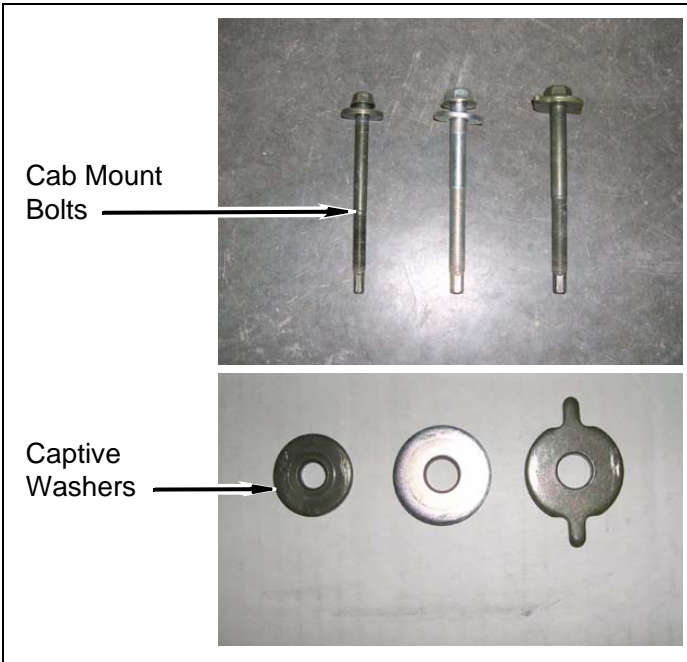

**NOTE**

The stock (OE) cab mounting captive washers will be reused. DO NOT DISCARD.

**WARNING**

Use extreme caution when lifting body from frame. To prevent serious personal injury, ensure the lifting device is securely placed. Keep your hands out from between the body and frame.

**CAUTION**

Continually check hoses, wires, lines, etc. to be sure that everything is flexing properly and not binding, or damage to the vehicle could result. Be especially careful of the a/c hoses at the fire wall, the belt pulley, and at the core support. Ensure brake lines stretch while lifting. Bending the lines to gain ample slack may be necessary. Be extremely careful not to kink the lines.

2. Cab passenger side

- a. Position a hydraulic floor jack and a wood block under passenger side of cab (under the body seam). Slowly lift cab just enough to install a **kit block** on top of factory upper bushing.

**WARNING**  
The **kit blocks** must be installed in addition to the factory upper and lower bushings. Installing the **kit blocks** without the factory upper and lower bushings could result in damage to the vehicle or serious personal injury.

- b. Install **kit block** (3" x 2") onto core support cab mount.

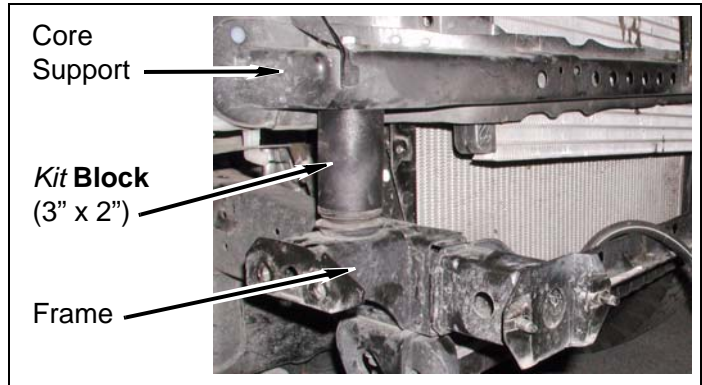

- c. Install **kit blocks** (3" x 3") onto upper bushings of middle and rear cab mounts.

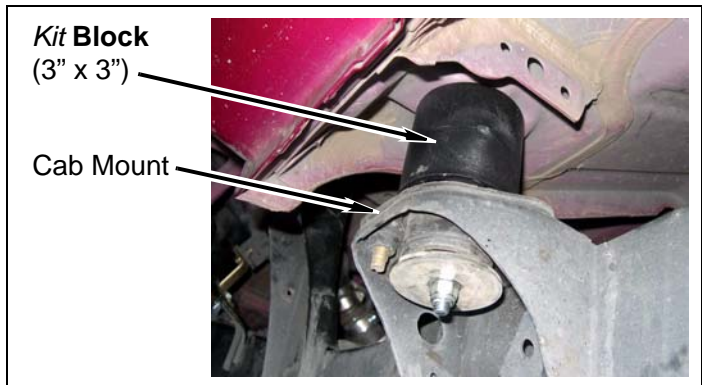

- d. Lower cab onto **kit blocks**.
- e. Install captive washer, **kit bolt** (3/8" x 7-1/2"), **kit nut** (3/8" Nylock), and lower washer into core support mount. DO NOT TIGHTEN.

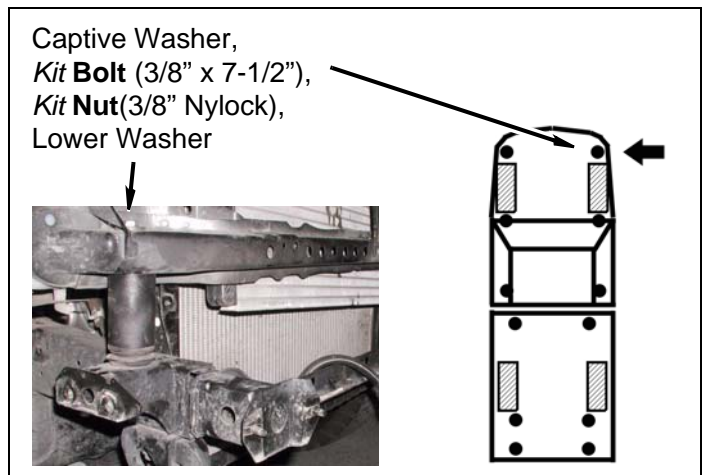

- f. Install captive washer, *kit bolt* (3/8" x 7"), *kit nut* (3/8" Nylock), and lower washer into middle cab mount. DO NOT TIGHTEN.

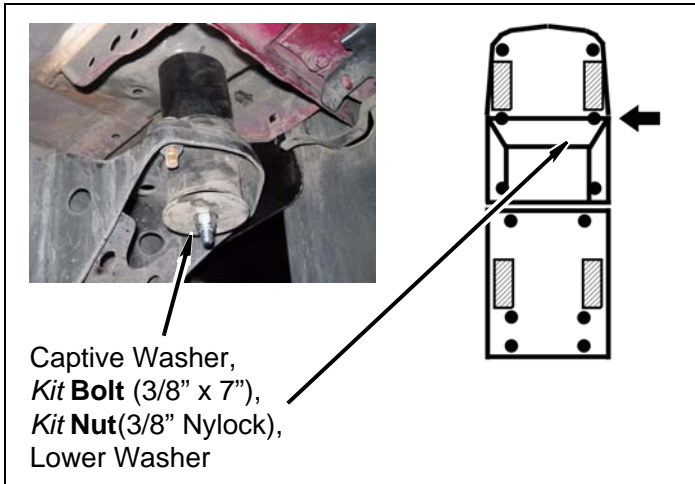

- g. **Standard & Extended Cab Models:** Install captive washer, *kit bolt* (3/8" x 6"), *kit nut* (3/8" Nylock), and lower washer into rear cab mount. DO NOT TIGHTEN.

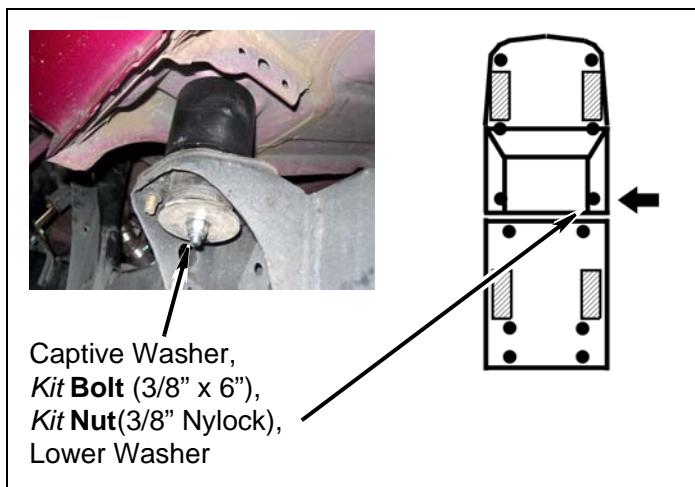

- h. **Crew Cab Models:** Install captive washer, *kit bolt* (3/8" x 8"), *kit nut* (3/8" Nylock), and lower washer into rear cab mount. DO NOT TIGHTEN.

3. Cab driver side

- a. Repeat previous steps on driver side of cab.
- b. Set cab-to-bed spacing according to previous measurement.
- c. Remove each *kit nut*, one at a time, and apply a few drops of *kit Loctite*® onto threads. Install *kit nut*, and lower washer. TORQUE each *kit bolt* to 55 ft. lbs.

**Bed**

1. Prepare to lift bed from frame

- a. Loosen, but DO NOT REMOVE, bed mounting bolts on driver side.

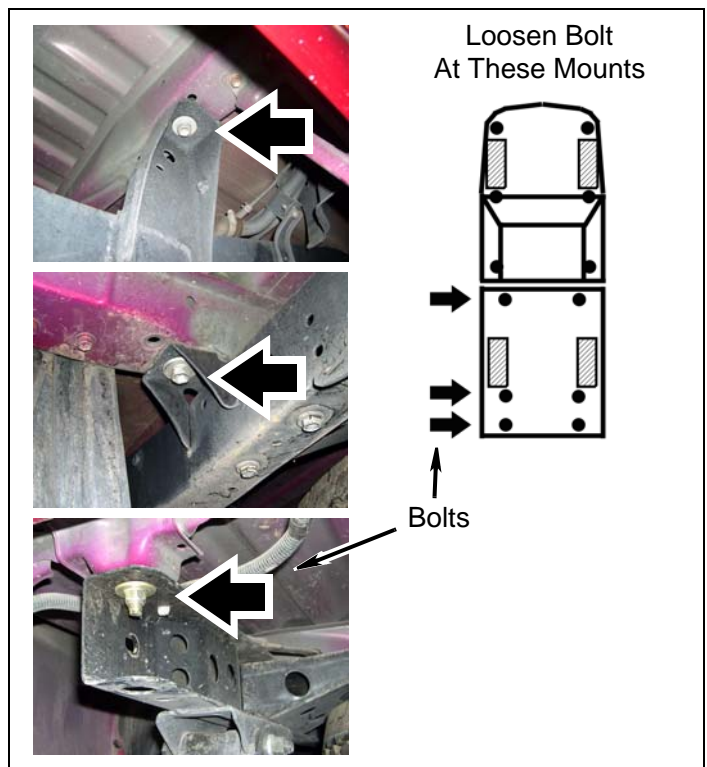

2. Remove bolt from each bed mount on passenger side.

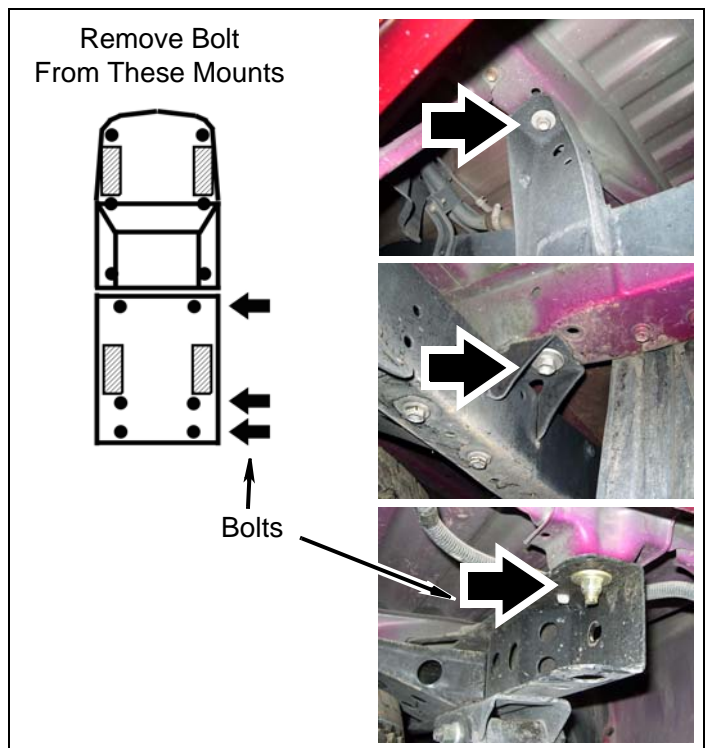

**⚠ WARNING**

Use extreme caution when lifting the bed from the frame. To prevent serious personal injury, ensure the lifting device is securely placed. Keep your hands out from between the bed and frame.

**⚠ CAUTION**

To prevent damage to the vehicle while lifting the bed, continually check hoses, wires, brake lines, etc. to ensure everything is flexing properly and not binding. Ensure clearance between bed and cab is maintained.

3. Bed passenger side

- a. Using a hydraulic floor jack and a wood block, slowly lift passenger side of bed a little more than 3".
- b. Install **kit block** (3" x 3") onto each front bed mount.

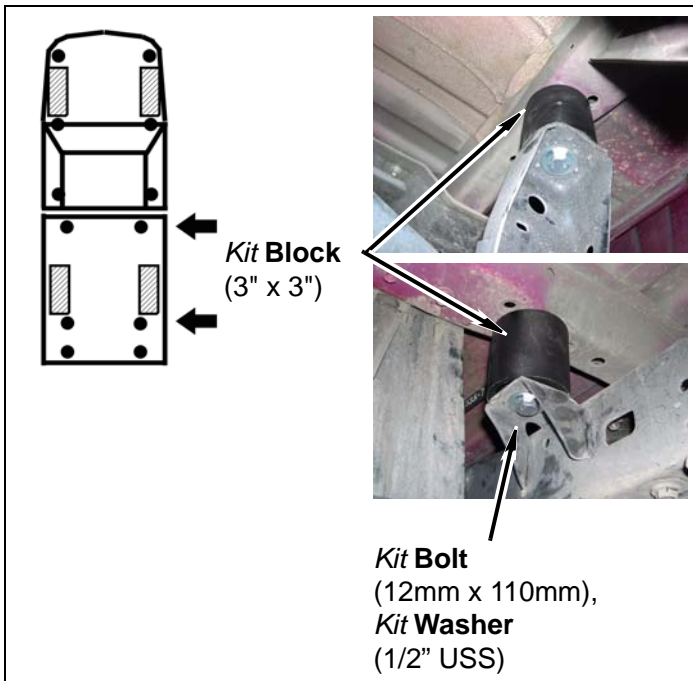

- c. Install **kit block** (3" x 2") onto rear bed mount.

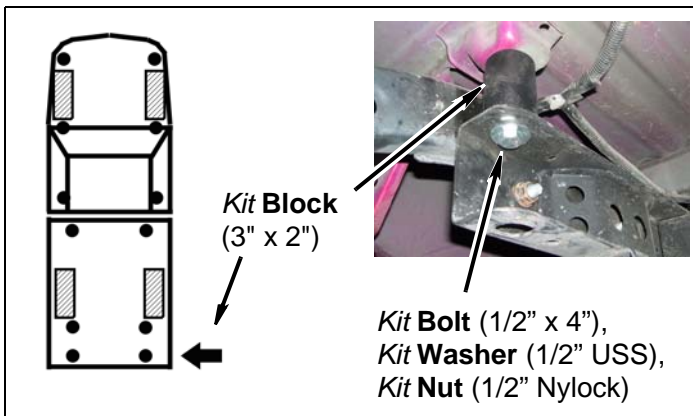

- d. Lower bed onto **kit blocks**.

- e. Install **kit bolt** (12mm x 110mm) and **kit washer** (1/2" USS) into each front bed mount. **DO NOT TIGHTEN**.

- f. Install **kit bolt** (1/2" x 4"), two **kit washers** (1/2" USS), and **kit nut** (1/2" Nylock) into rear bed mount. **DO NOT TIGHTEN**.

4. Bed driver side

- a. Repeat previous steps on driver side of bed.
- b. Set bed-to-cab spacing according to previous measurement.
- c. Remove each **kit bolt**, one at a time, and apply a few drops of **kit Loctite®** to threads. Install **kit bolt** with **kit washer**. Tighten each **kit bolt** to 55 ft. lbs.

**Rear of Vehicle**

1. Rear bumper

**⚠ WARNING**

The following procedure is intended only to enhance the appearance of the vehicle. The rear bumper will no longer be rated for towing of any kind. Towing with the rear bumper after it has been lifted can result in death, serious personal injury, or damage to the vehicle. Towing after the bumper has been lifted should be accomplished using a rated Class III receiver type hitch.

- a. Remove tab from driver and passenger side rear bumper brackets.

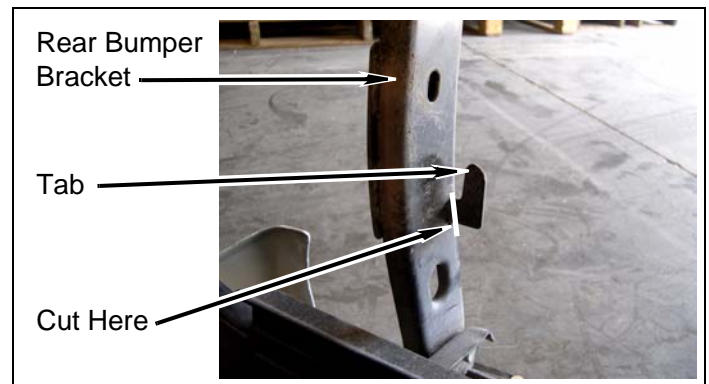

- b. Remove four bolts and two rear bumper brackets from rear bumper.

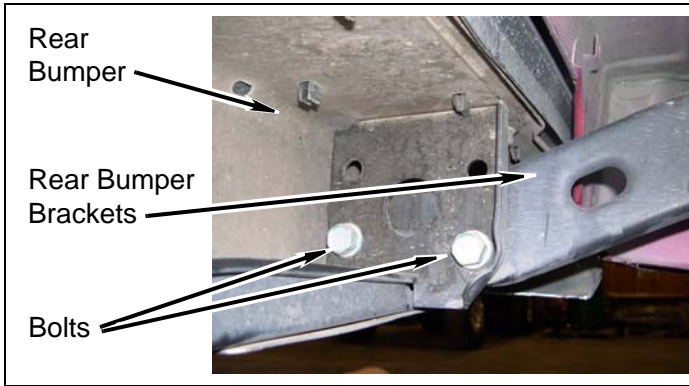

- c. Apply a small amount of *kit* **Loctite**® onto threads of four bolts and install two *kit* **brackets** (bumper, rear) onto frame with four bolts.

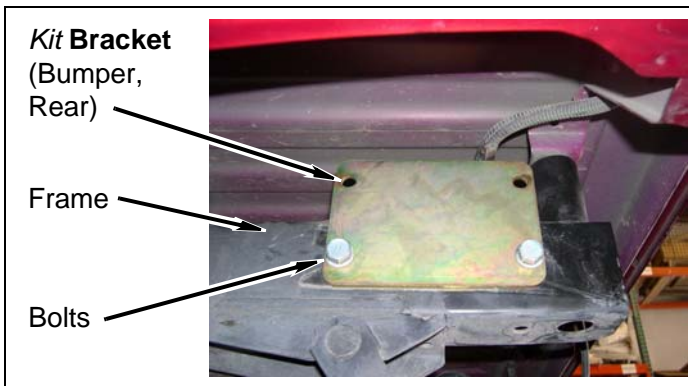

- d. Apply a small amount of *kit* **Loctite**® onto threads of four *kit* **bolts** (7/16" x 1") and install rear bumper brackets onto two *kit* **brackets** (bumper, rear) with eight *kit* **washers** (7/16" USS), and four *kit* **nuts** (7/16" Nylock). **DO NOT TIGHTEN.**

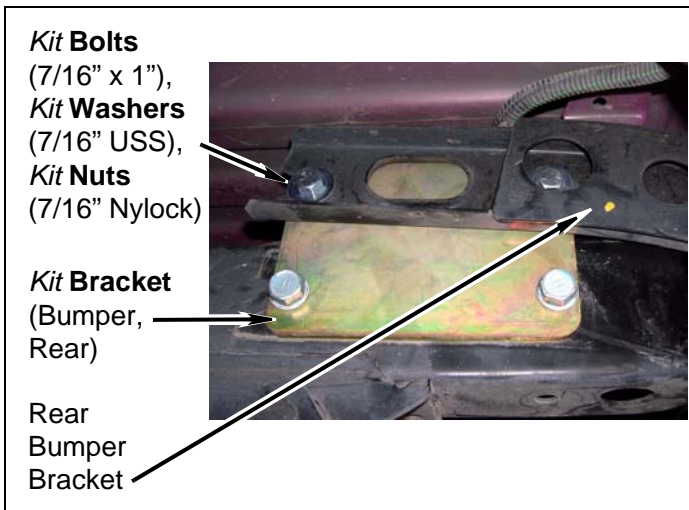

- e. Apply a small amount of *kit* **Loctite**® onto threads of four bolts and install rear bumper onto two rear bumper brackets.

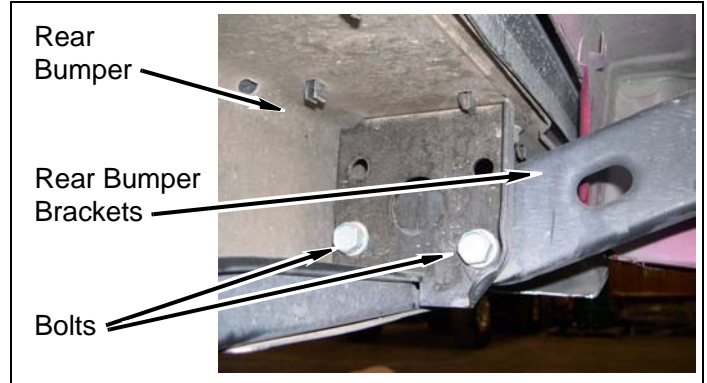

- f. Adjust rear bumper to previously recorded measurement. **TIGHTEN** four *kit* **bolts** (7/16" x 1").

- g. Install two license plate light wire harness connectors onto rear bumper.

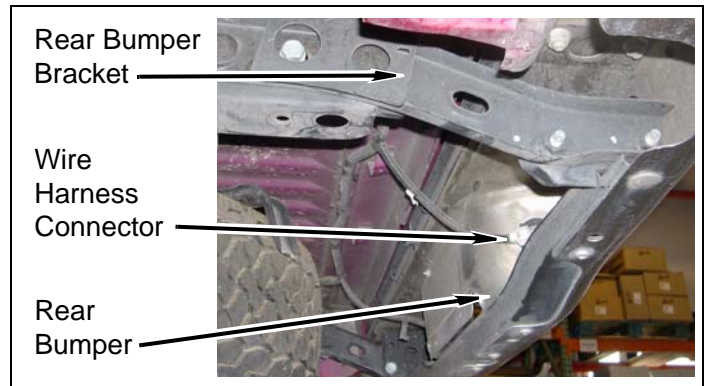

- h. If equipped, install two bolts and trailer hitch wire harness connector onto rear bumper.

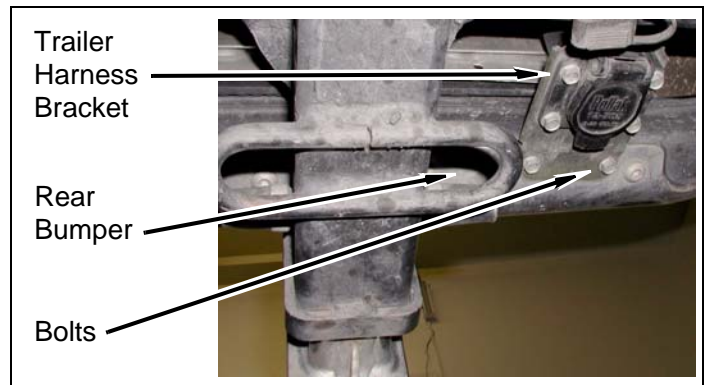

2. **2001-2002 Models: Fuel filler**

**⚠ WARNING**

Use extreme caution when working near the fuel lines and the fuel tank. Clean up spilled fuel immediately. A spark could cause an explosion or fire resulting in serious personal injury and property damage.

a. Remove bolt and fuel filler from frame bracket.

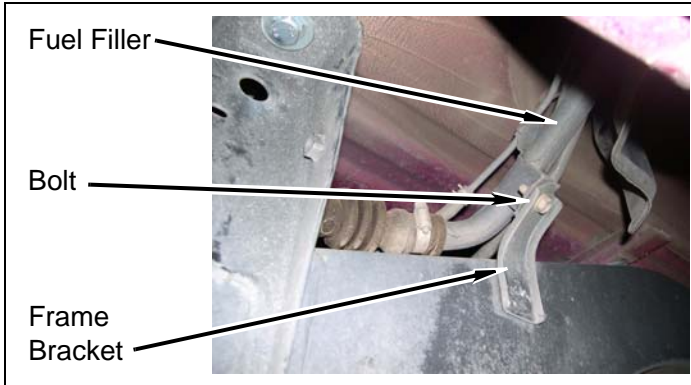

b. Loosen two hose clamps at fuel tank and remove fuel filler from vehicle.

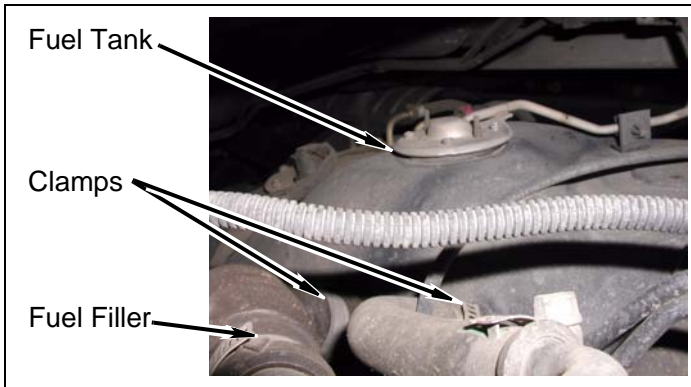

c. Remove clamp and vent hose from fuel filler assembly.

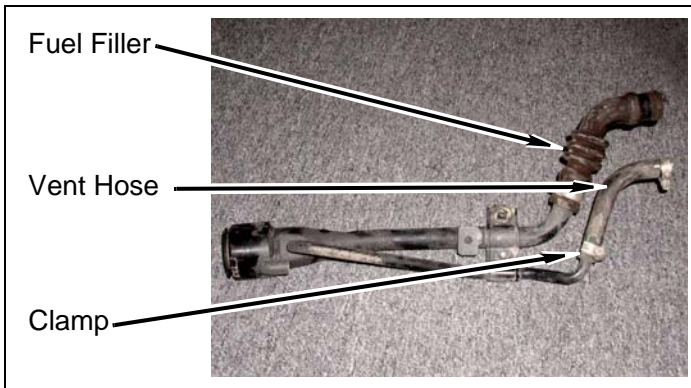

d. Install *kit hose* (1/2" x 11") onto fuel filler vent tube with *kit clamp* (#10 hose).

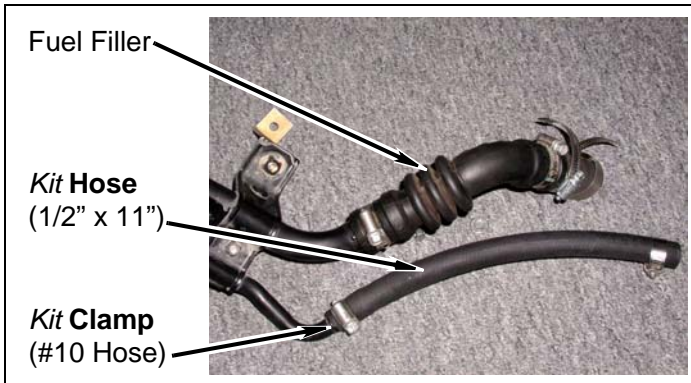

e. Install *kit hose* (1" x 2") onto fuel tank with *kit clamp* (#28 hose).

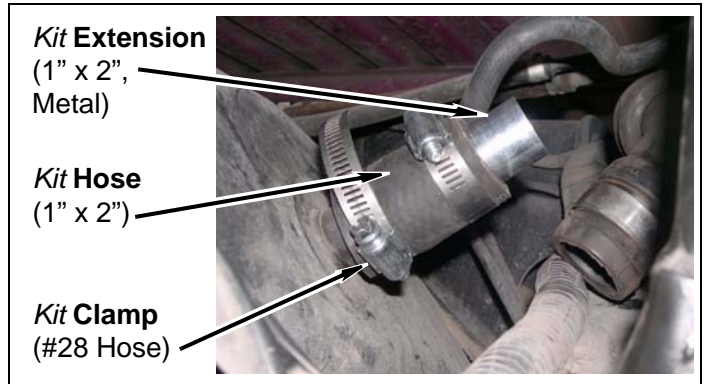

f. Install *kit extension* (1" x 2", metal) into *kit hose* (1" x 2") with *kit clamp* (#28 hose).

g. Install *kit bracket* (3", Z-shaped) onto fuel filler with bolt.

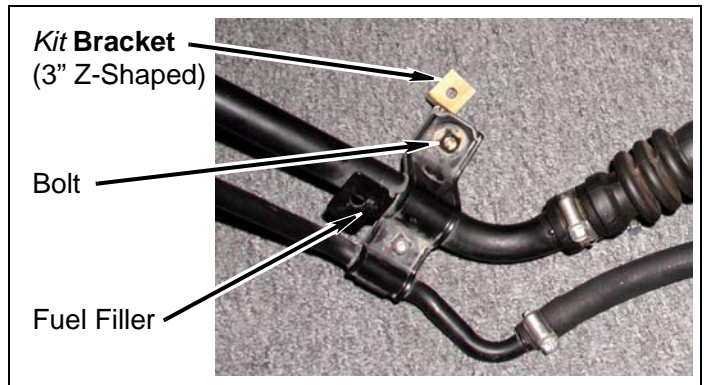

h. Install fuel filler and *kit hose* (1/2" x 11") onto fuel tank and *kit hose* (1" x 2") with *kit clamp* (#10 hose) and clamp. DO NOT TIGHTEN.

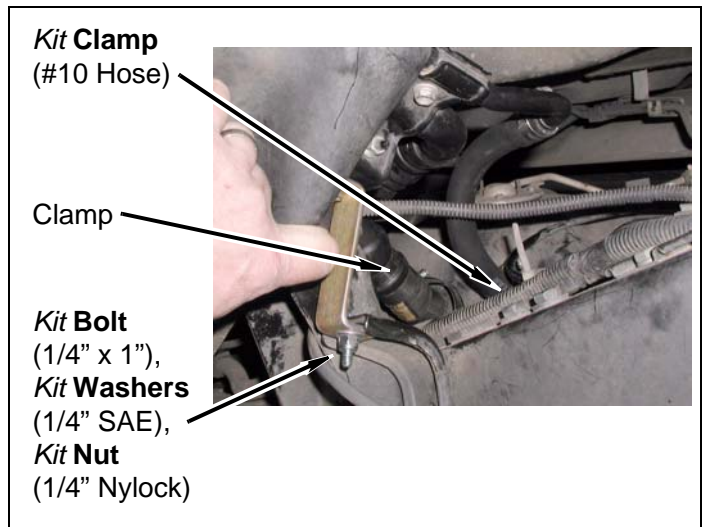

i. Install *kit bracket* (3" Z-shaped) onto frame bracket with *kit bolt* (1/4" x 1"), two *kit washers* (1/4" SAE), and *kit nut* (1/4" Nylock).



- j. Install filler surround onto bed with four screws.  
Install fuel cap onto fuel filler.

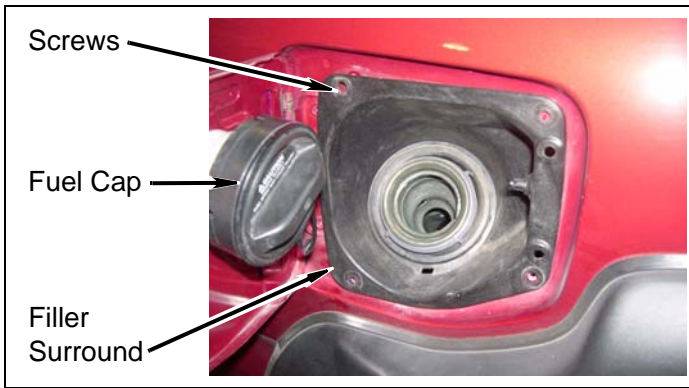

- c. Remove two hose clamps and two small vent hoses from fuel filler.

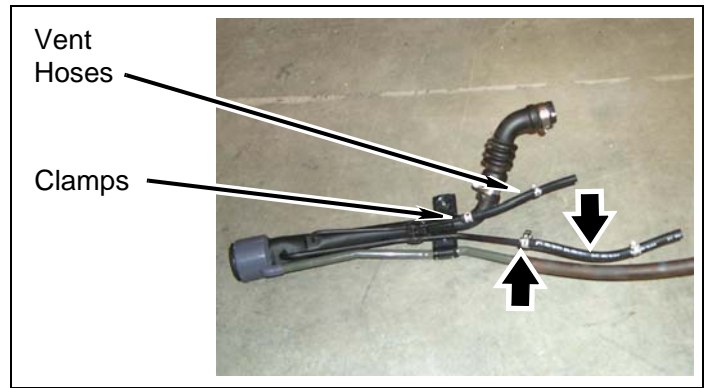

3. **2003-2004 Models:** Fuel filler

**⚠ WARNING**  
Use extreme caution when working near the fuel lines and the fuel tank. Clean up spilled fuel immediately. A spark could cause an explosion or fire resulting in serious personal injury and property damage.

- a. Remove bolt and fuel filler from frame bracket.

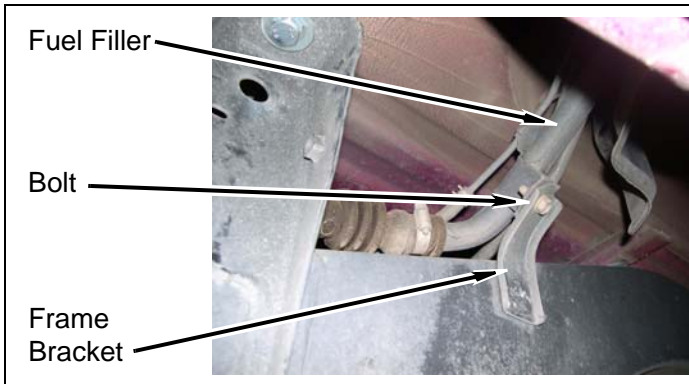

- b. Loosen four hose clamps at fuel tank and remove fuel filler from vehicle.

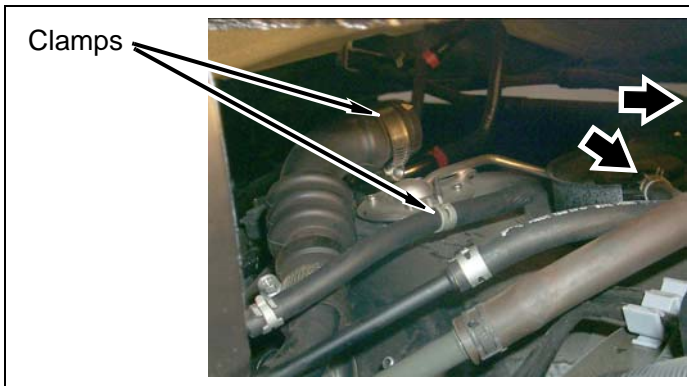

- d. Install two *kit hoses* (1/4" x 11") onto two fuel filler vent tubes with two *kit clamps* (#10 hose).

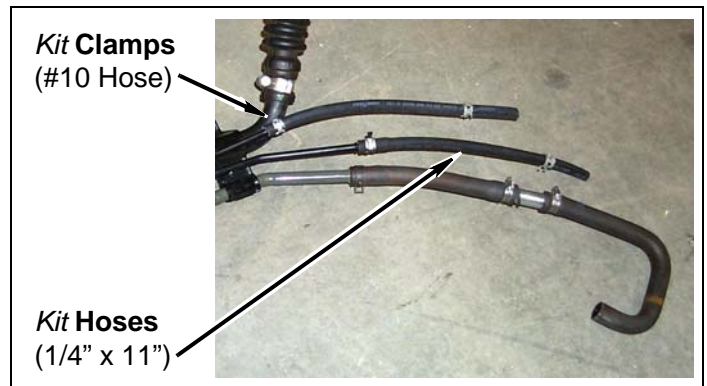

- e. Install *kit hose* (1" x 2") onto fuel tank with *kit clamp* (#28 hose).

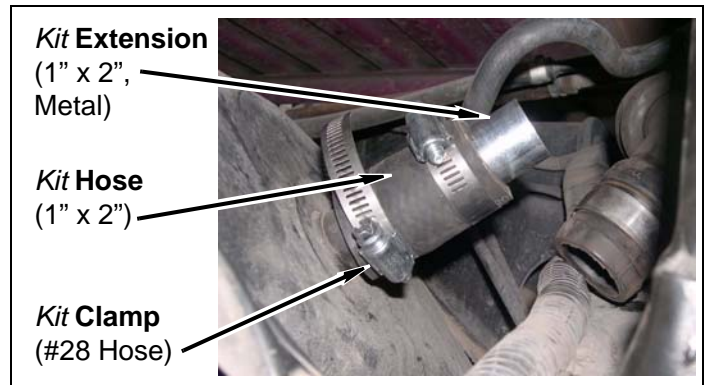

- f. Install *kit extension* (1" x 2", metal) into *kit hose* (1" x 2") with *kit clamp* (#28 hose).

g. Mark and cut large vent hose as shown.

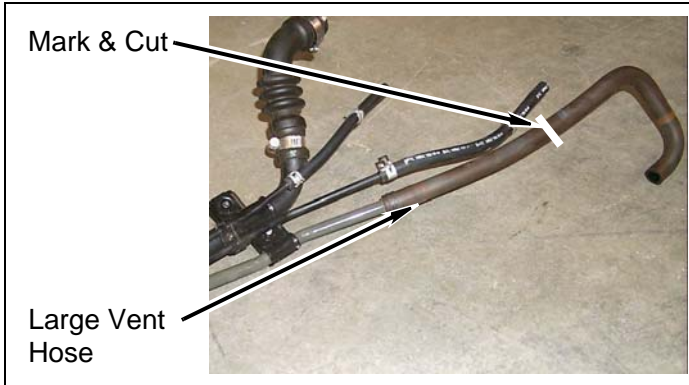

h. Install **kit extension** (5/8" x 3", metal) between two cut sections of large vent hose with two **kit clamps** (#10 hose).

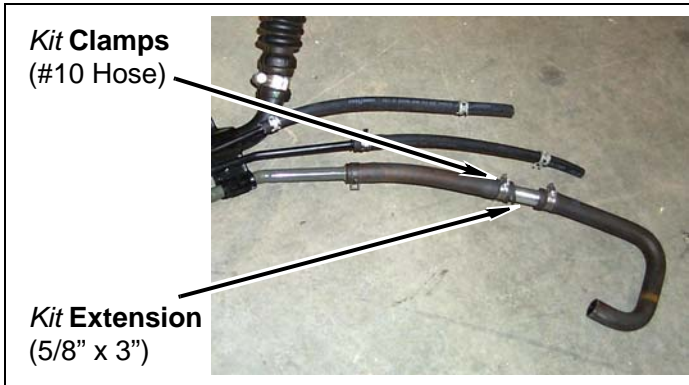

i. Install **kit bracket** (2" Z-shaped) onto fuel filler with bolt.

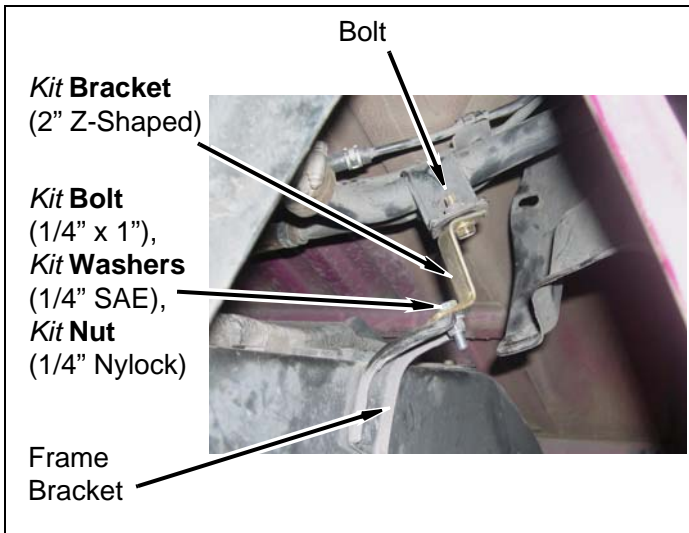

j. Install **kit bracket** (2" Z-shaped) onto frame bracket with **kit bolt** (1/4" x 1"), two **kit washers** (1/4" SAE), and **kit nut** (1/4" Nylock).

k. Install fuel filler, large vent hose, and two **kit hoses** (1/4" x 11") onto fuel tank and **kit hose** (1" x 2") with clamp, **kit clamp** (#10), and two small vent hose clamps. **DO NOT TIGHTEN.**

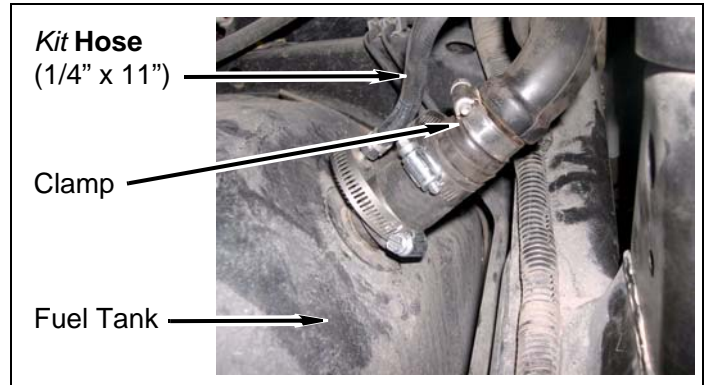

l. Install filler surround onto bed with four screws. Install fuel cap onto fuel filler.

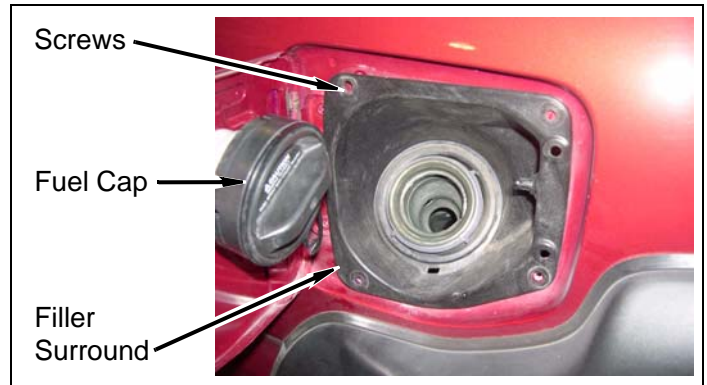

## Inside of Vehicle

1. Manual transfer case

### **⚠ WARNING**

Welding should **ONLY** be performed by a certified welder or welding facility.

a. Mark line along length of shift lever and **kit extension** (shift lever). Mark cut line across shift lever as shown.

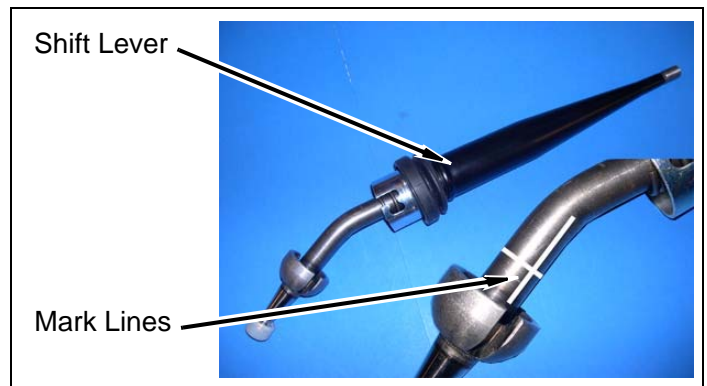

- b. Cut shift lever along cut line and deburr edges.
- c. Position **kit extension** (shift lever) between two cut halves of shift lever. Ensure previously marked lines are aligned.

- c. Position **kit extension** (shift lever) between two cut halves of shift lever. Ensure previously marked lines are aligned.

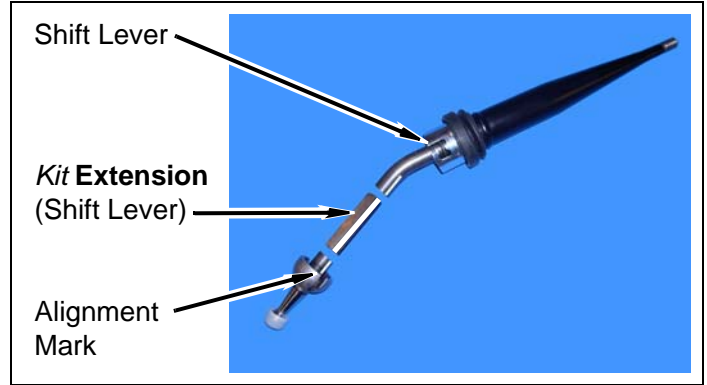
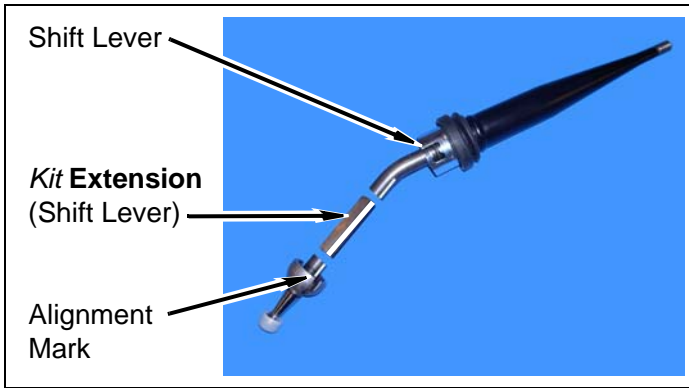

- d. Weld **kit extension** (shift lever) onto shift lever.

- d. Weld **kit extension** (shift lever) onto shift lever.

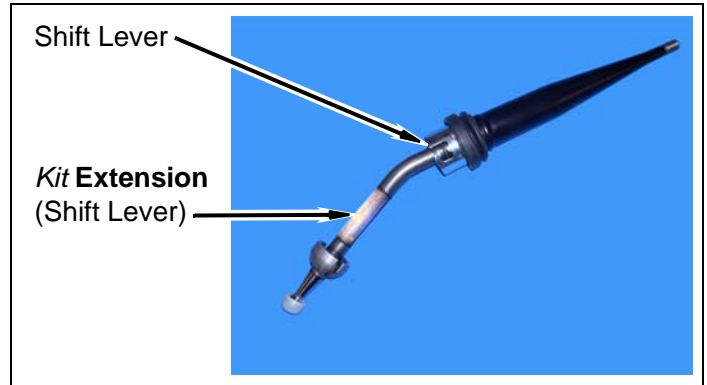
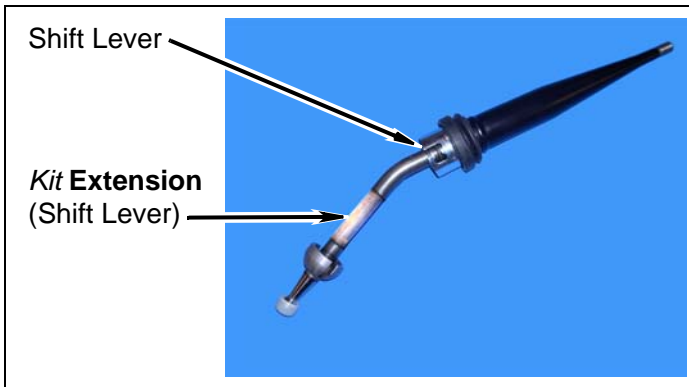

- e. Remove shop rags or towels covering transmission and transfer case holes.

- f. **Manual transfer case models:** Install transfer case shift lever, lower boot, two covers, spring, and C-clip onto transfer case.

## 2. Manual transmission

**⚠ WARNING**  
Welding should **ONLY** be performed by a certified welder or welding facility.

- a. Mark line along length of shift lever and **kit extension** (shift lever). Mark cut line across shift lever as shown.

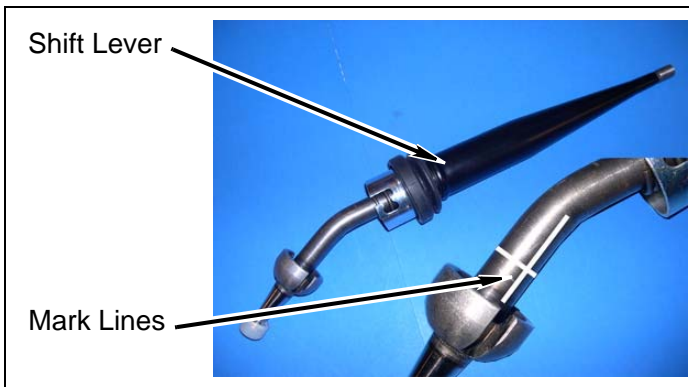

- b. Cut shift lever along cut line and deburr edges.

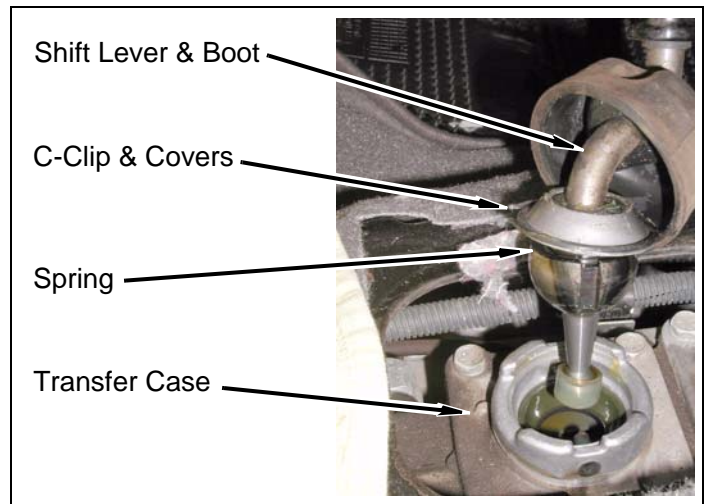

g. **Manual transfer case models:** Install lower transfer case shift lever boot onto transfer case.

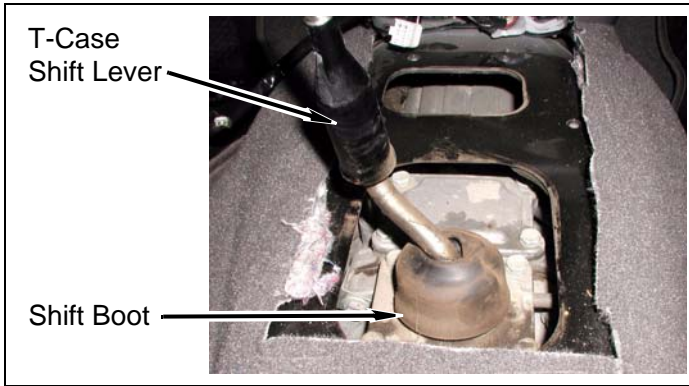

h. Install transmission shift lever, lower boot, locking collar, and spring onto transmission.

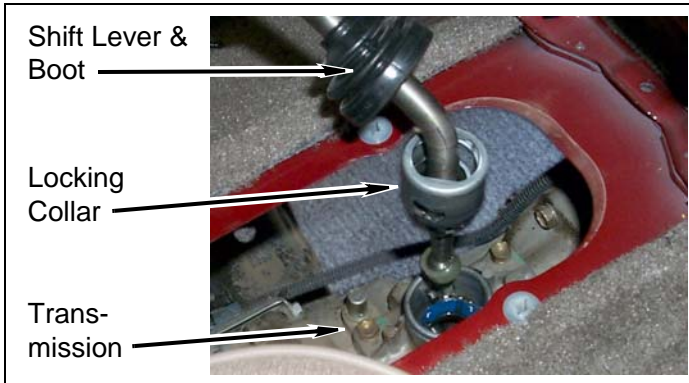

i. Install intermediate shift boot and adapter plate onto vehicle with four bolts.

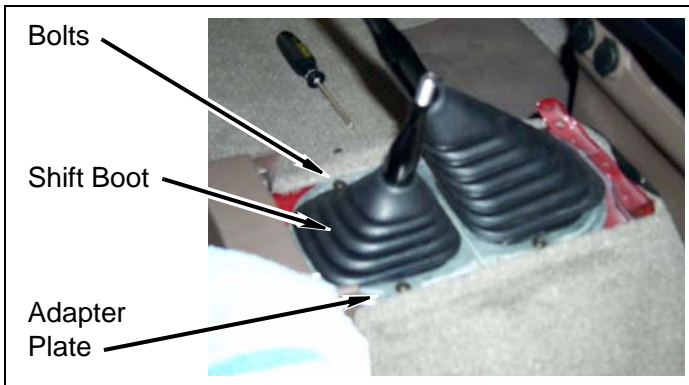

j. Install outer transmission shift lever boot and shift lever console with two screws.

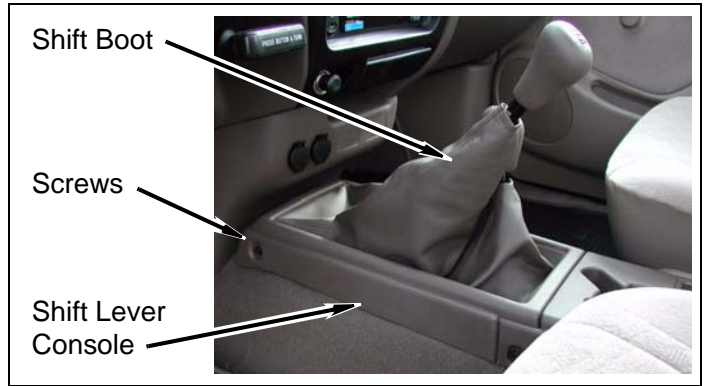

k. Install rear center console onto shift lever console with four bolts and two screws.

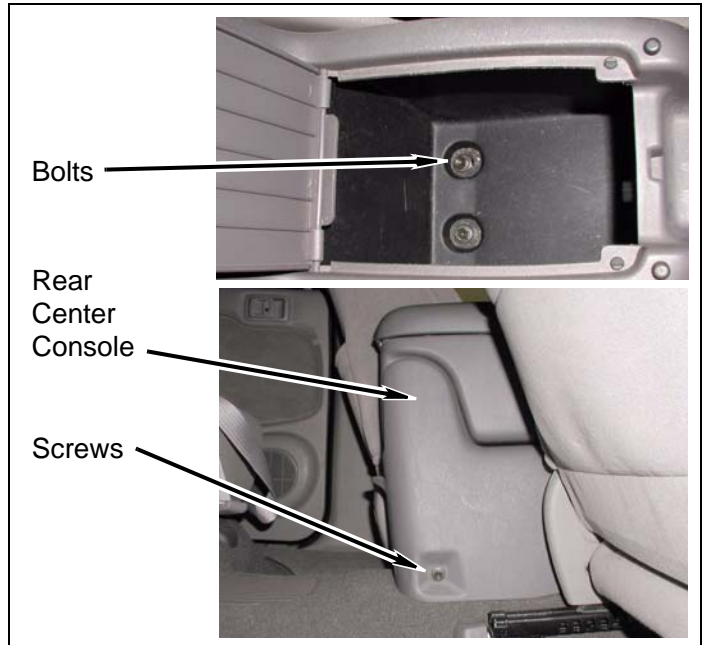

l. Install transmission and transfer case shift knobs onto transmission shift lever and transfer case shift lever, respectively.

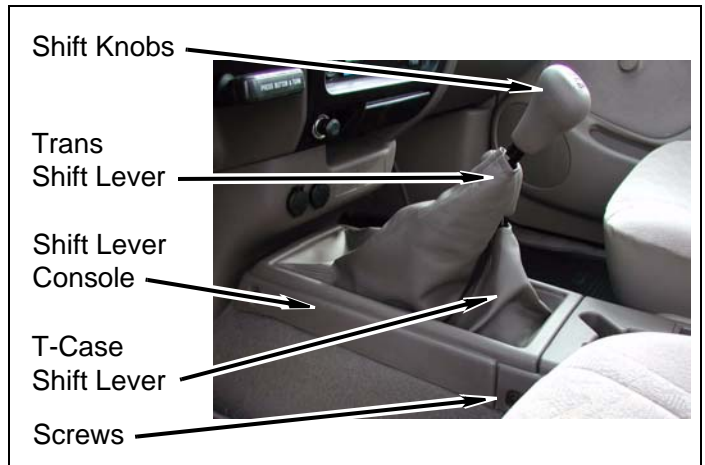

3. Automatic transmission

- a. Remove shop rags or towels covering transfer case holes.
- b. **Manual transfer case models:** Install transfer case shift lever, lower boot, two covers, spring, and C-clip onto transfer case.

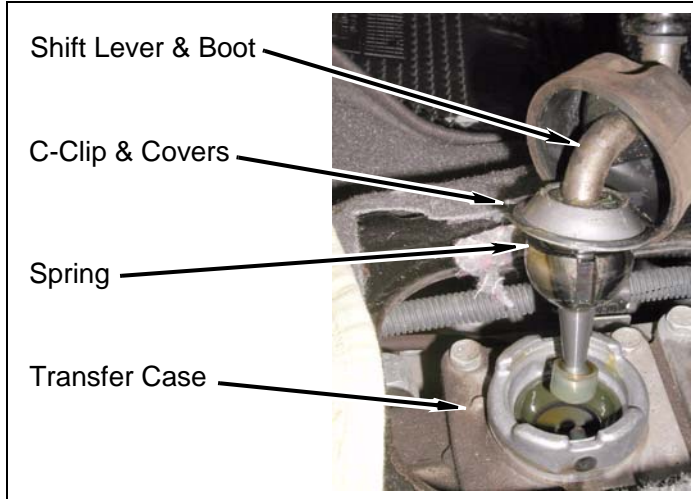

- c. **Manual transfer case models:** Install lower transfer case shift lever boot onto transfer case.

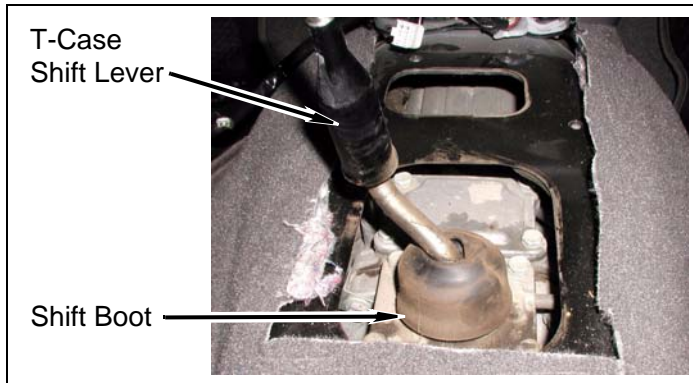

- d. Install transmission shift lever, intermediate shift boot, and adapter plate onto vehicle with eight bolts.

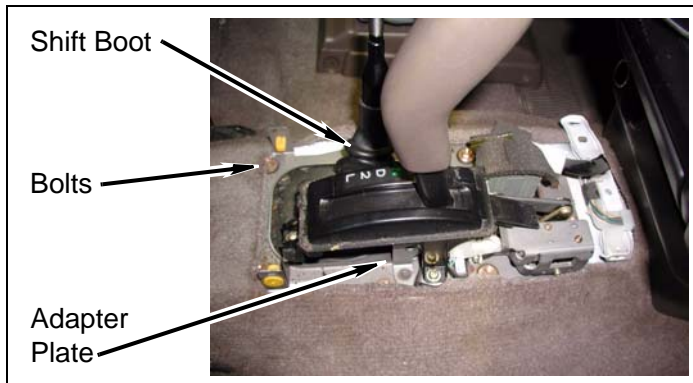

- e. Connect transmission wiring harness.

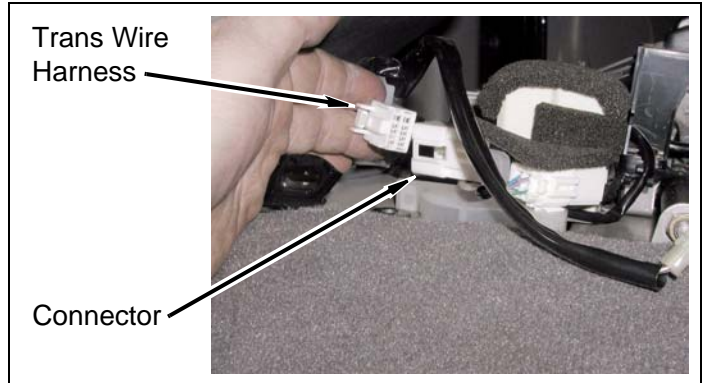

- f. Connect transfer case shift knob wiring harness.

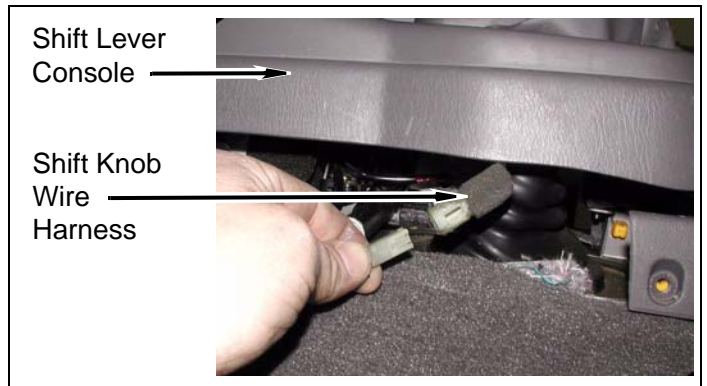

- g. Install shift lever console and transfer case shift lever boot onto vehicle with two screws.

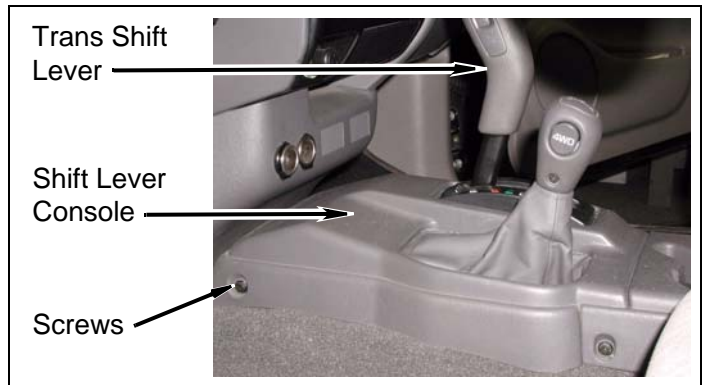

h. Install rear center console onto shift lever console with four bolts and two screws.

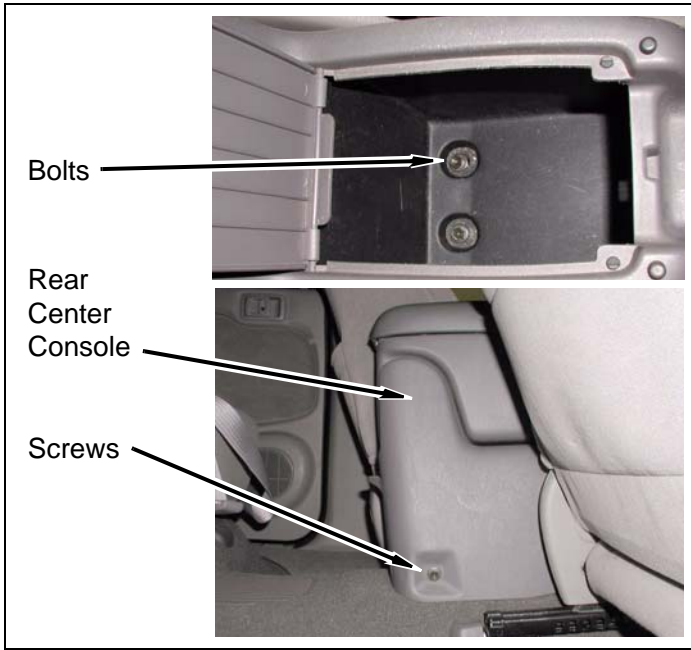

i. Install transfer case shift knob onto shift lever with screw.

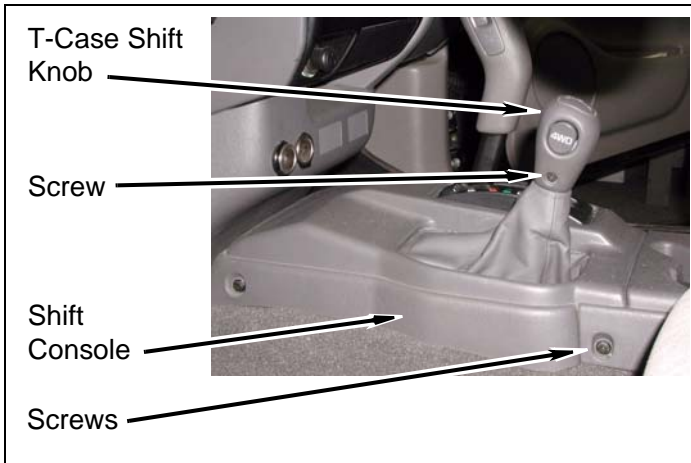

4. Front interior

a. Install driver and passenger plastic access covers and lay carpet down.

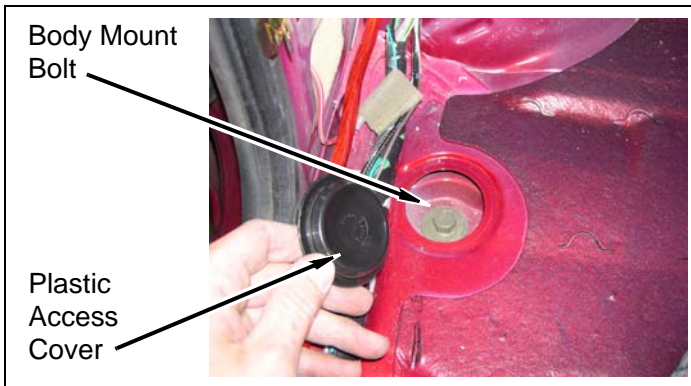

b. Install driver and passenger kick panels.

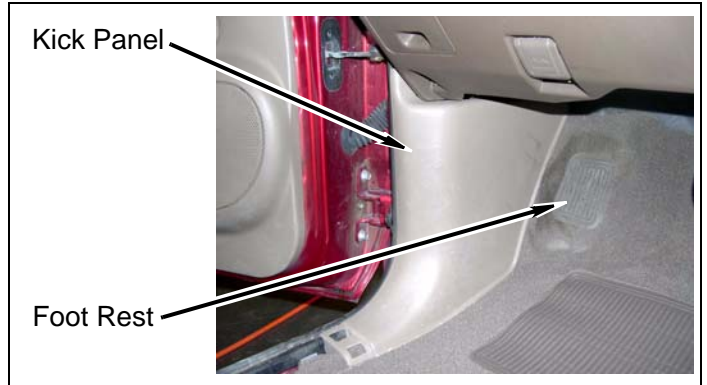

c. Install passenger and driver scuff plates onto door jambs with eight screws.

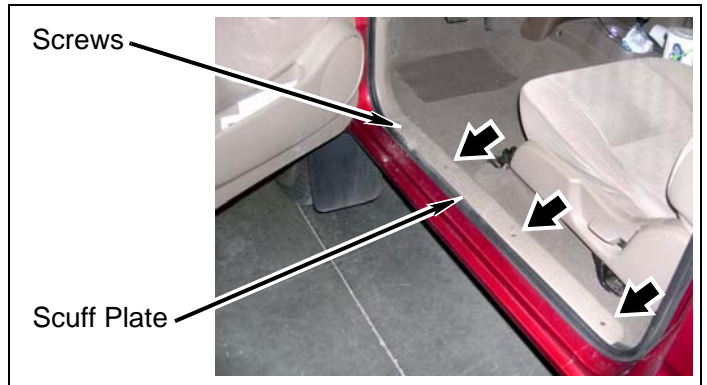

5. Rear interior

a. Install driver and passenger plastic access covers and lay carpet down.

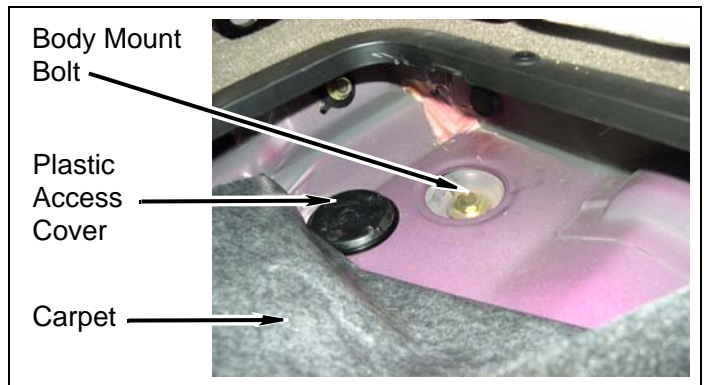

- b. **Extended & Crew Cab Models:** Install two floor storage covers onto floor.

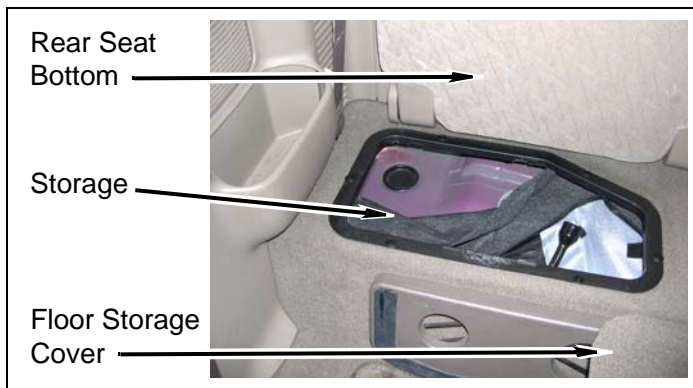

**Underside of Vehicle**

1. Install bracket onto driver side wheel well with two nuts.

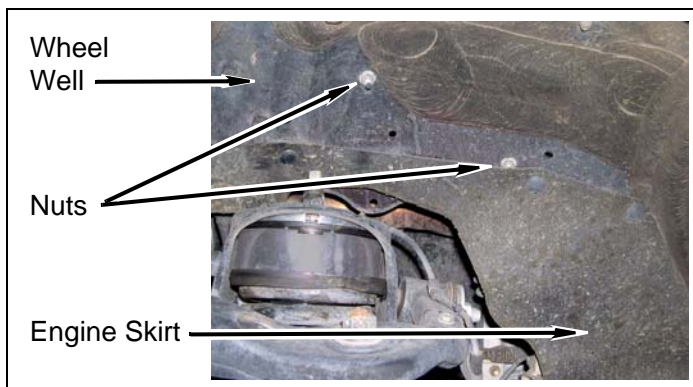

2. Install parking brake cable onto driver side frame bracket with clip.

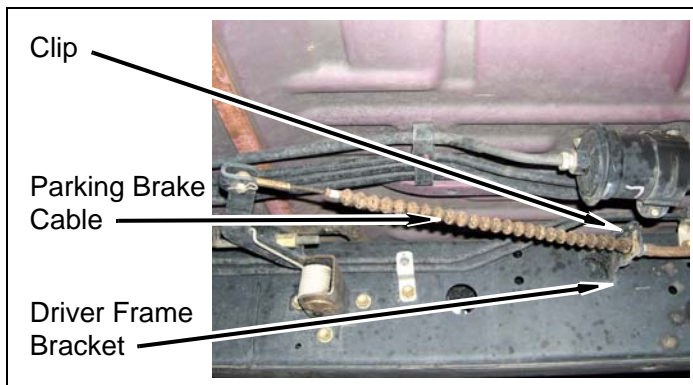

**NOTE**  
It may be necessary to bend one or more of the forward parking brake cable brackets.

3. Passenger side frame wiring harness

- a. Install *kit bracket* (3" Z-shaped) onto passenger side frame with bolt.

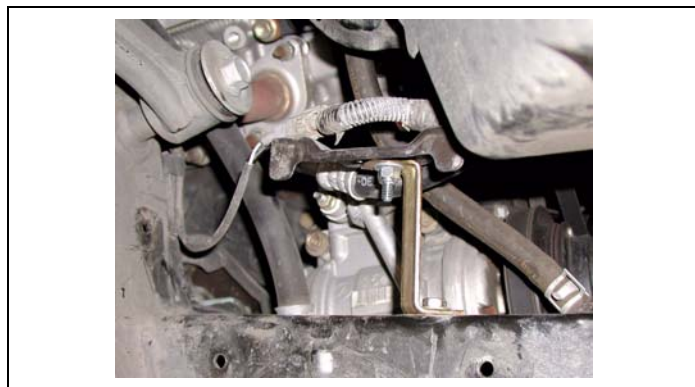

- b. Install wiring harness bracket onto *kit bracket* (3" Z-shaped) with *kit bolt* (1/4" x 1"), two *kit washers* (1/4" SAE), and *kit nut* (1/4" Nylock).

4. **Automatic Transmission Models:** Ensure previously made marks are aligned and install automatic transmission shift lever onto shift linkage with pin and cotter key (or nut).

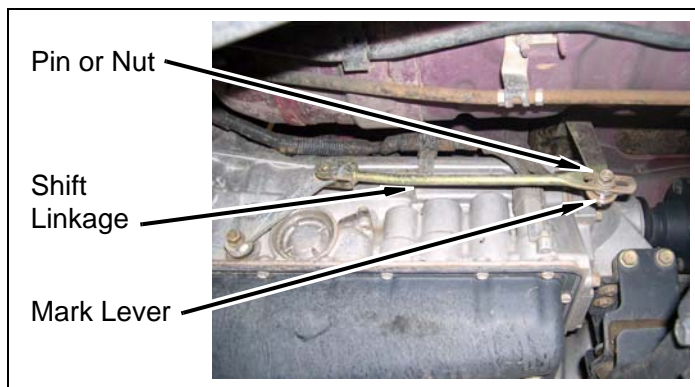

**NOTE**  
It may be necessary to adjust the automatic transmission shift linkage after completing the installation of this kit.

## 5. Crush blocks

### ⚠ WARNING

Welding should ONLY be performed by a certified welder or welding facility.

- a. Install two (or four for long bed models) **kit blocks** (crush) between frame and bed rail as shown. Weld each **kit block** (crush) onto frame.

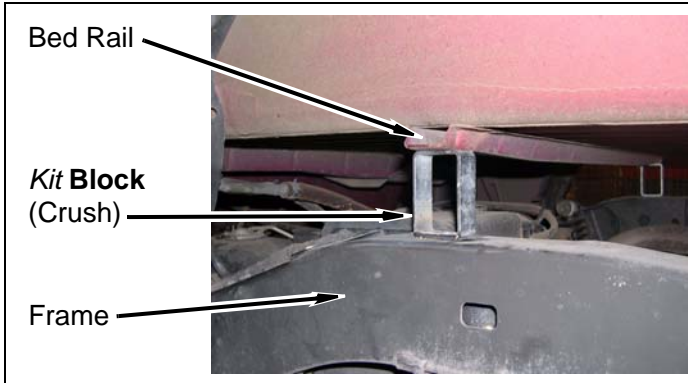

## Engine Compartment

### 1. Firewall wiring harness bracket

- a. Remove bolt and passenger side firewall bracket.
- b. Turn passenger side firewall bracket 180° and install onto firewall with bolt.

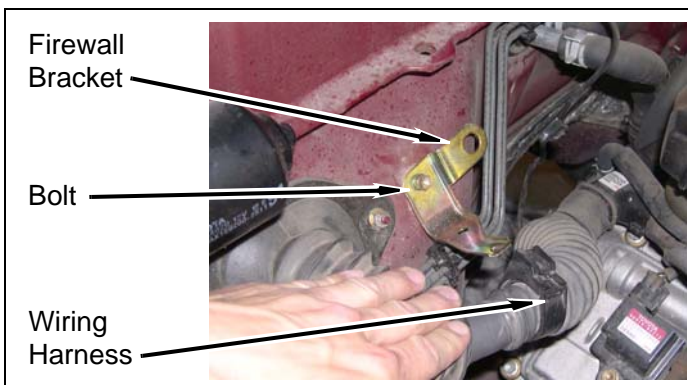

- c. Install wiring harness and clip onto firewall bracket.

## 2. Radiator

- a. Install four **kit brackets** (radiator) onto radiator with four bolts.

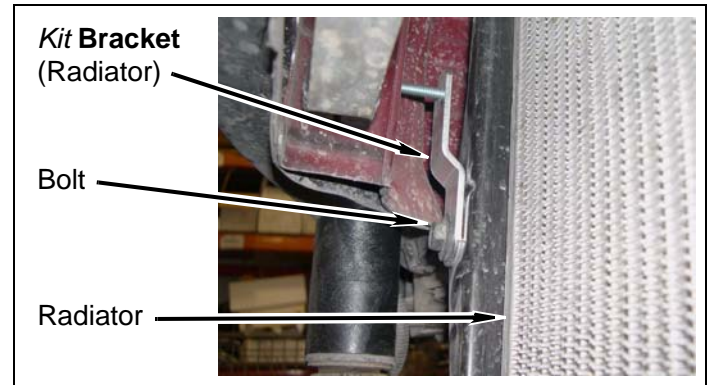

- b. Install radiator onto core support with four **kit washers** (1/4" SAE) and four **kit nuts** (1/4" Nylock).

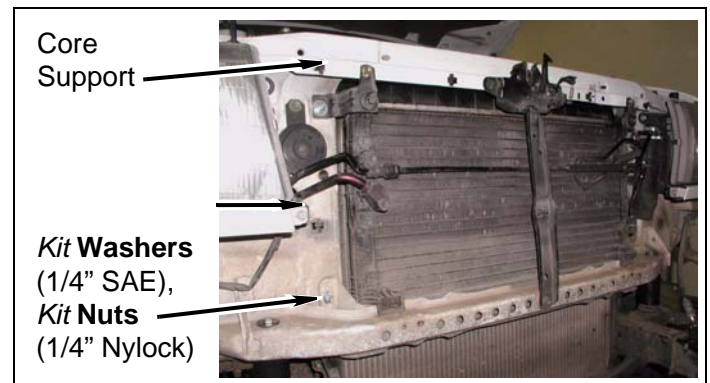

3. Install radiator overflow reservoir onto core support and connect overflow hose.

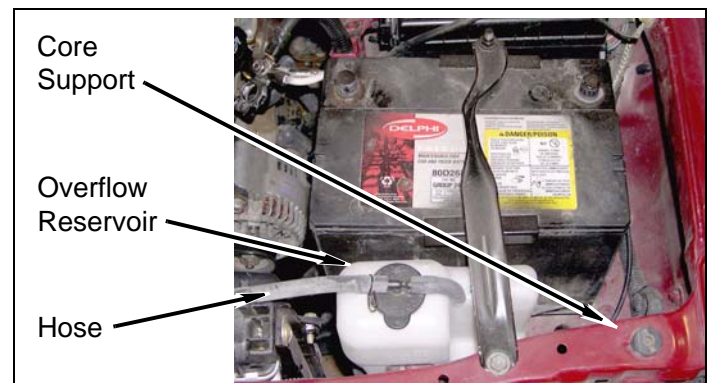



4. **4WD Models:** Axle vent lines

- a. Install **kit bracket** (3-hole) onto driver side wheel well with bolt.

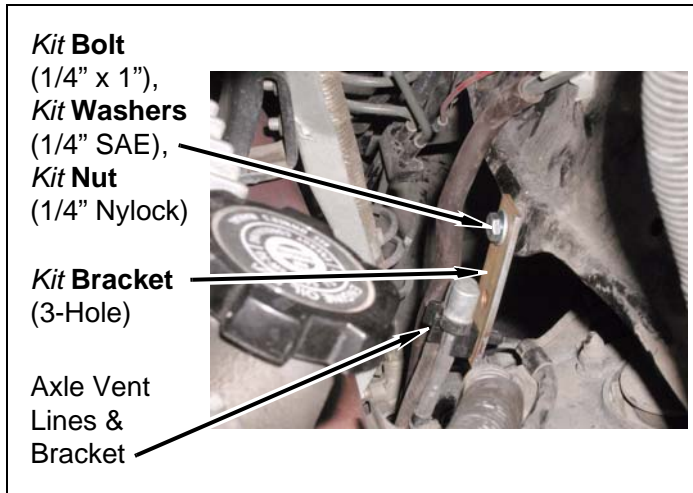

- b. Install axle vent lines and clip onto **kit bracket** (3-hole) with **kit bolt** (1/4" x 1"), two **kit washers** (1/4" SAE), and **kit nut** (1/4" Nylock).

5. Install vacuum line onto two clips.

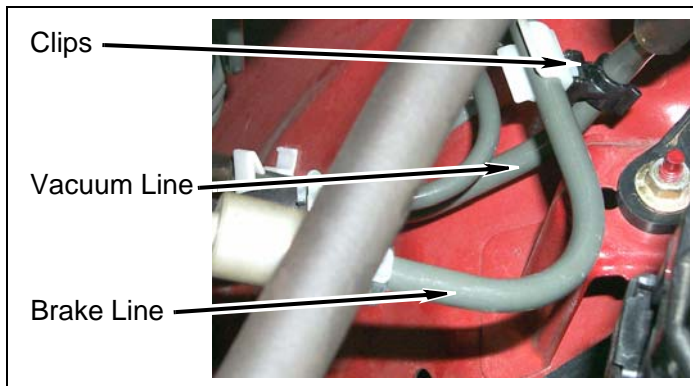

6. Positive battery cable wiring harness

- a. Install **kit bracket** (3" Z-shaped) onto driver side frame with bolt.

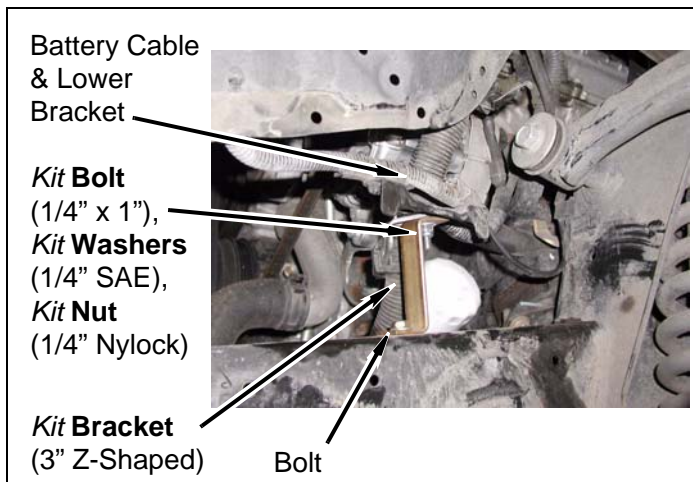

- b. Install positive battery cable and lower bracket, if equipped, onto **kit bracket** (3" Z-shaped) with **kit bolt** (1/4" x 1"), two **kit washers** (1/4" SAE), and **kit nut** (1/4" Nylock).

7. Install battery and battery tie down into vehicle with nut and bolt.

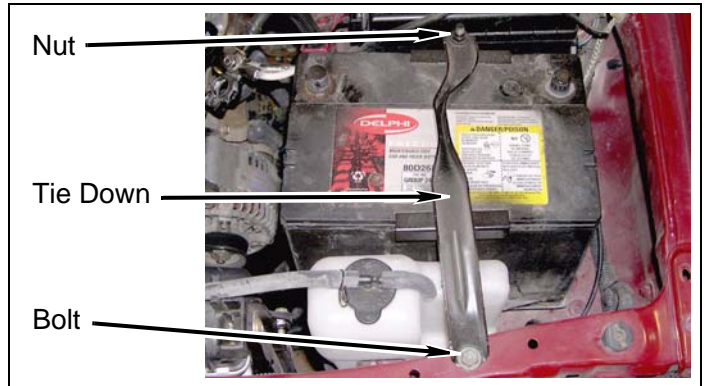

8. Install air intake hose onto airbox with clamp.

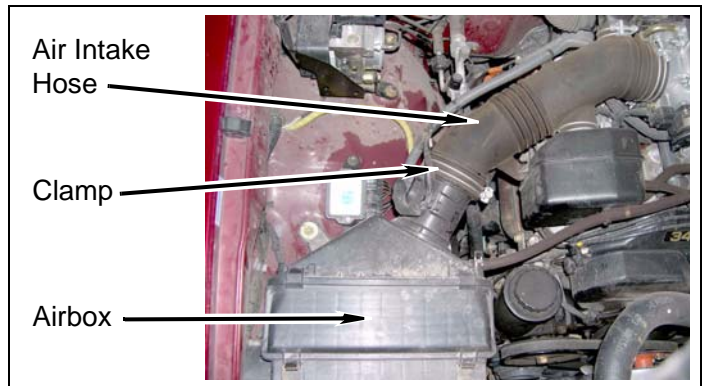

9. Steering shaft

**⚠ WARNING**

Verify the steering extension is securely installed as specified in the instructions. Failure to do so may cause steering malfunction, resulting in property damage or serious personal injury.

- a. Remove two bolts, two flat washers, two lock washers, two nuts, and upper rag joint plate from rag joint.

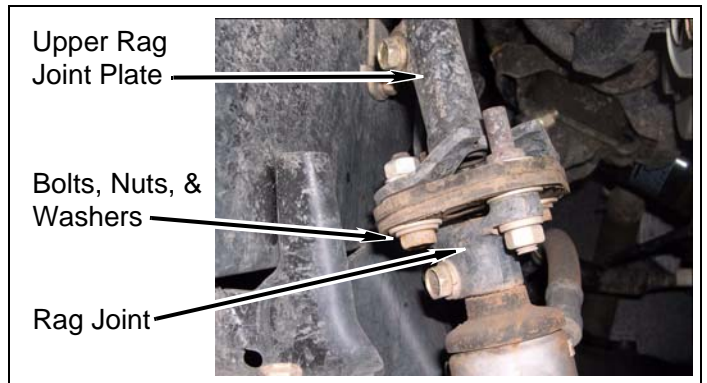

- b. Install *kit extension* (steering) onto steering shaft and slide up. Ensure marks on steering shaft and *kit extension* (steering) are aligned.

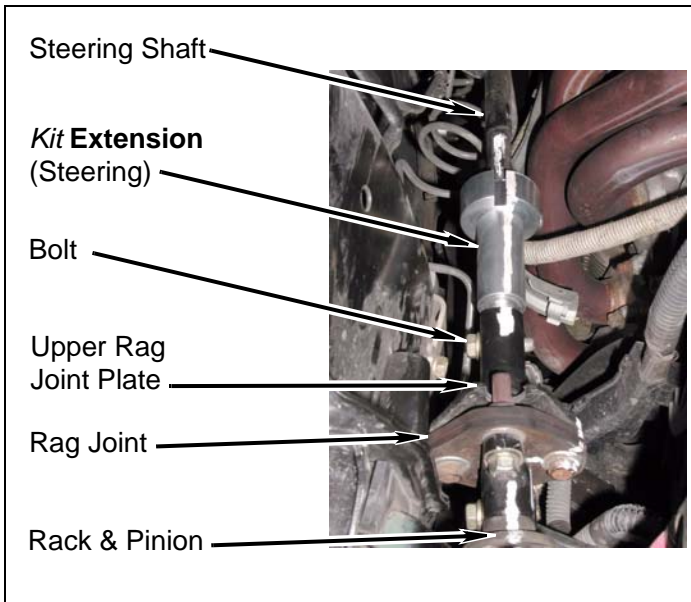

- c. Install upper rag joint plate onto *kit extension* (steering). Ensure marks on upper rag joint plate and *kit extension* (steering) are aligned.
- d. Slide *kit extension* (steering) and upper rag joint plate down and install upper rag joint plate onto rag joint with two bolts, two flat washers, two lock washers, and two nuts. Ensure marks on rag joint and upper rag joint plate are aligned.

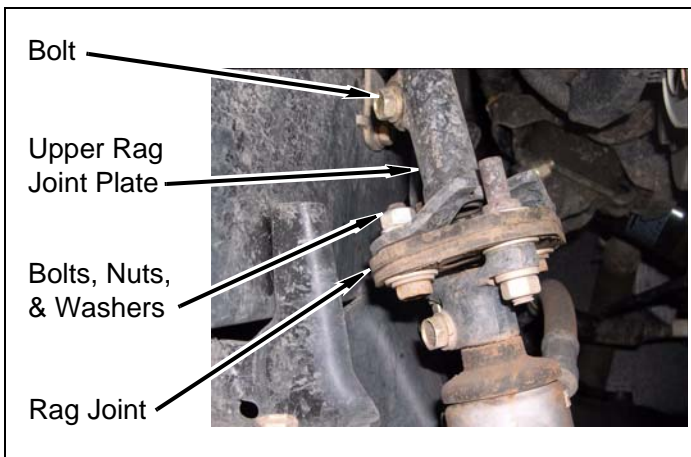

- e. Apply a small amount of *kit Loctite*® onto threads of factory bolt and install into upper rag joint plate. TORQUE bolt to 33 ft.-lbs.
- f. Apply a small amount of *kit Loctite*® onto threads of *kit bolt* (3/8" x 1-1/4", allen) and install into *kit extension* (steering). TORQUE bolt to 33 ft.-lbs.

## Front of Vehicle

### 1. Front bumper

- a. Install *kit bracket* (bumper, front, crush, left) onto frame with bolt, *kit bolt* (7/16" x 1"), two *kit washers* (7/16" USS), and *kit nut* (7/16" Nylock).

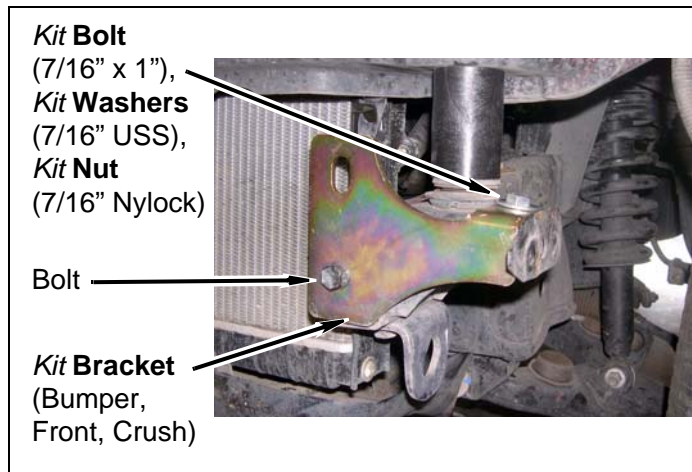

- b. Repeat above step for *kit bracket* (bumper, front, crush, right).
- c. Install two *kit brackets* (bumper, front) onto frame with four bolts.

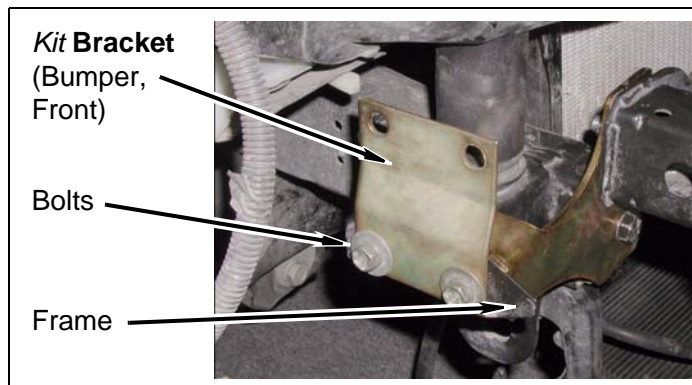

- d. Install oil cooler onto core support and crush zone with four brackets and two bolts.

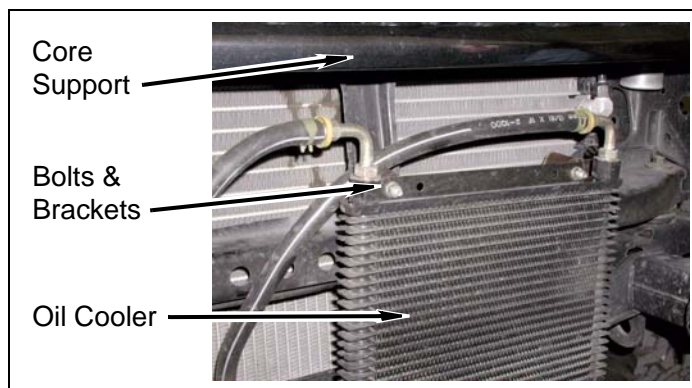

e. Install crush zone onto two **kit bracket** (bumper, front, crush) with two **kit bolts** (7/16" x 1"), four **kit washers** (7/16" USS), and two **kit nuts** (7/16" Nylock).

h. Install front bumper valence onto **kit brackets** (bumper, front) with four **kit bolts** (7/16" x 1"), eight **kit washers** (7/16" USS), and four **kit nuts** (7/16" Nylock). DO NOT TIGHTEN.

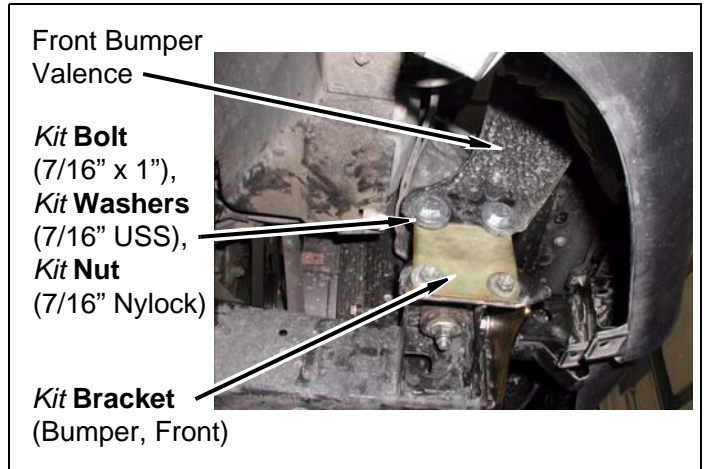
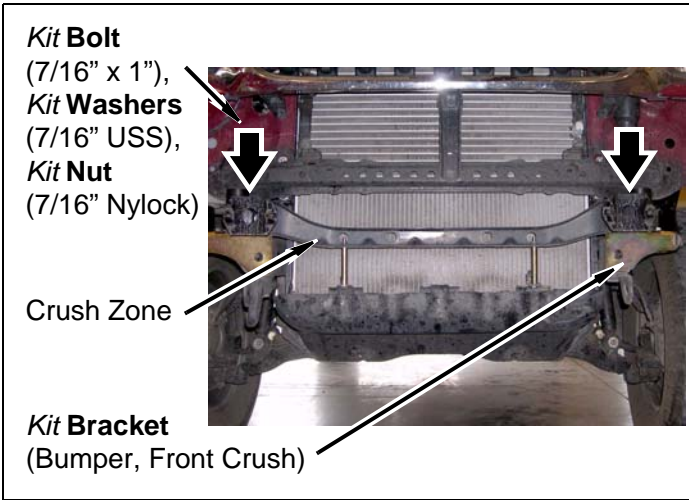

f. Install front bumper onto crush zone with four nuts.

i. Install front bumper valence onto driver and passenger fenders with two nuts.

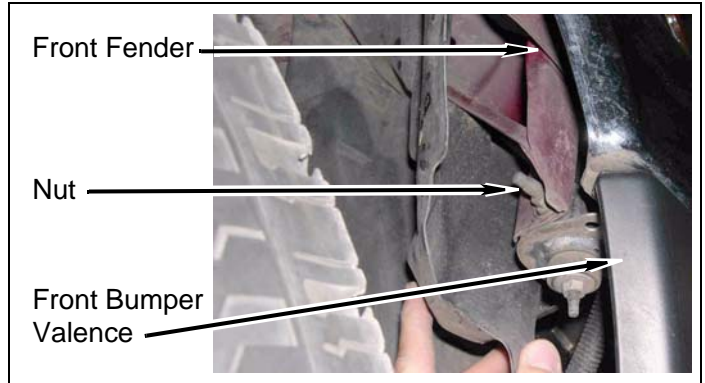
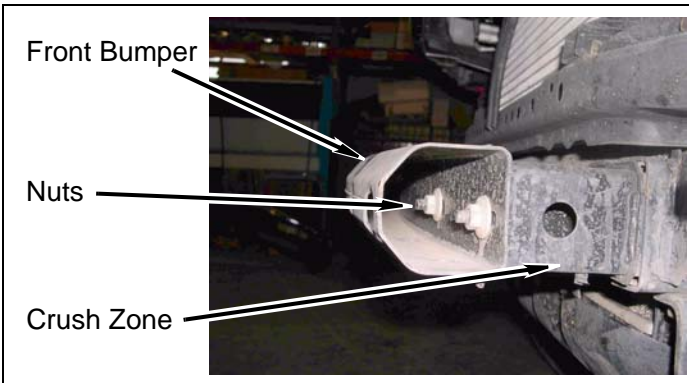

g. Install skid plate onto crush zone with three **kit spacers** (1/2" x 3"), three **kit bolts** (8mm x 100mm), and three **kit washers** (8mm).

j. Install lower bumper valence onto crush zone with two push clips.

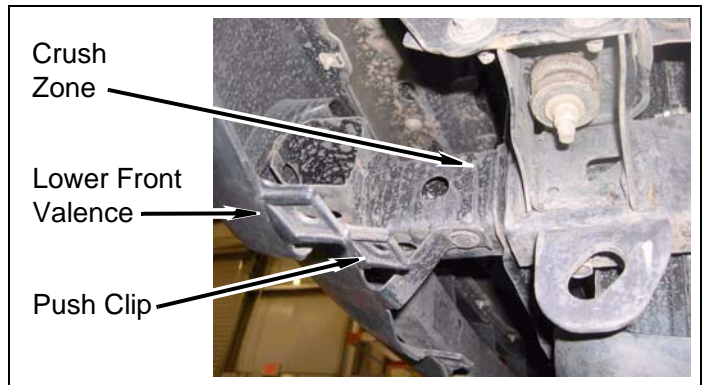
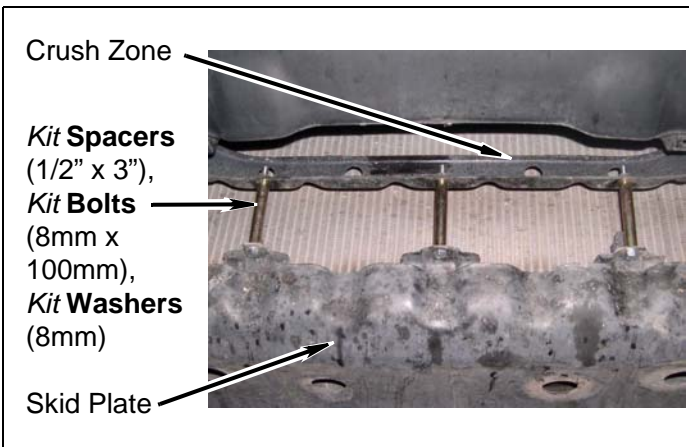

- k. Connect two fog light wire harnesses onto two fog lights, if equipped.

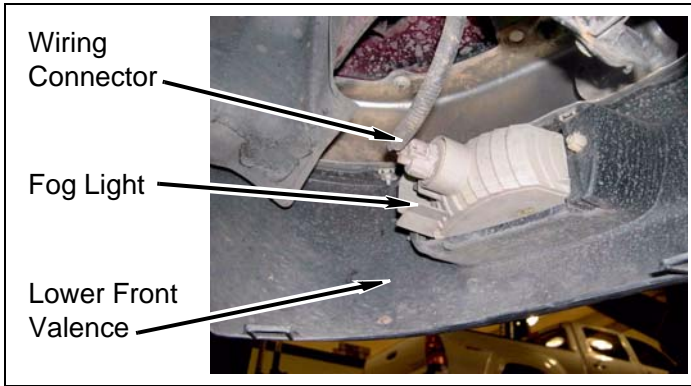

- c. Install grill onto core support with two screws.

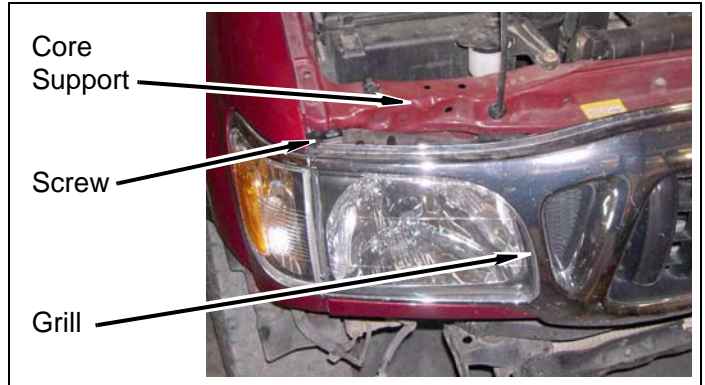

2. Grill

- a. Remove nine clips from core support and install onto grill.

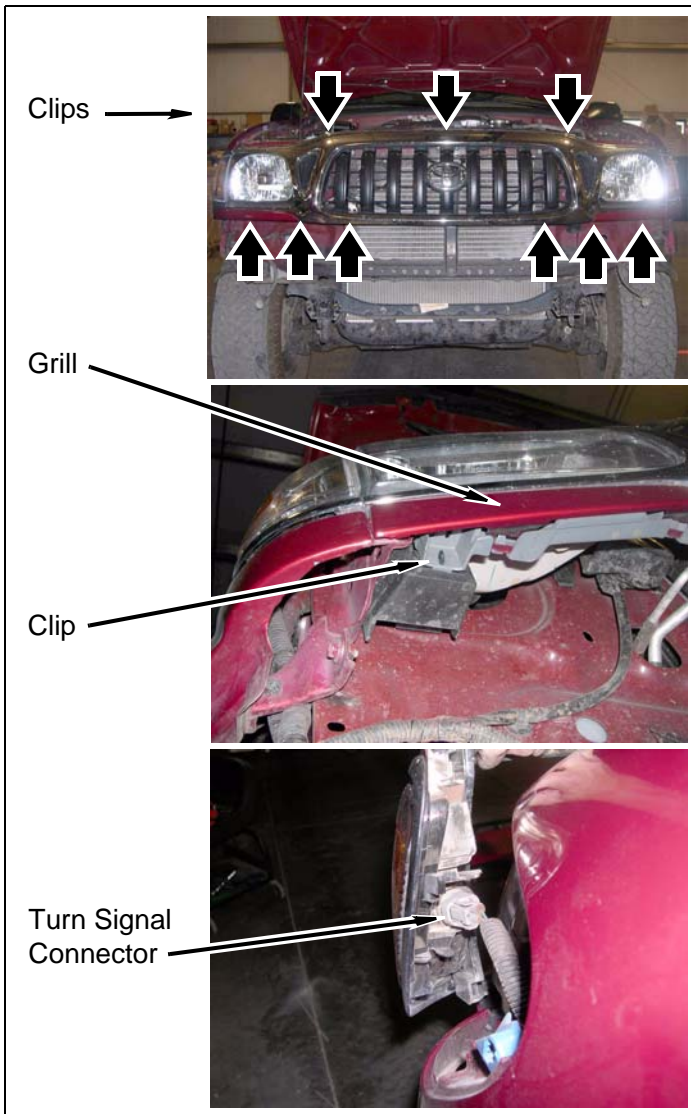

- b. Install two turn signal connectors and grill onto vehicle.

## After Completing Installation

### Engine Compartment

1. Connect both battery cables. Connect positive cable first, then negative cable.

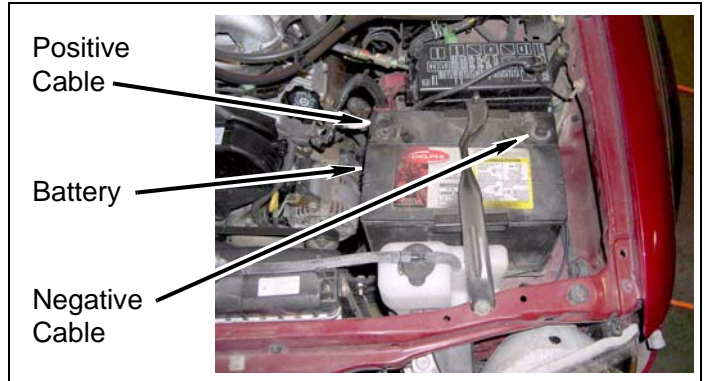

2. Install airbag fuse and fuse block cover.

### Miscellaneous

1. Apply *kit label* (warning) onto dashboard in plain sight of all vehicle occupants.
2. Check all fasteners to ensure they are tight.
3. Ensure all wires, hoses, cables, etc. are properly connected and there is ample slack.
4. **Automatic Transmission Models:** Check transmission for proper gear engagement. Adjust shift linkage, if necessary.

5. Adjust headlights.

**⚠WARNING**

If the engine cooling system is hot, the coolant will be HOT and UNDER PRESSURE. To prevent serious personal injury, wait until the cooling system is completely cool before removing the cap from the radiator.

6. Start engine and top off cooling system. Purge air from cooling system according to manufacturer's instructions. Install radiator cap.

## Dynamic Vehicle Check

1. Check steering in both directions to ensure that there is no bind. Check operation of clutch, brake system, and parking brake. Check operation of transmission and transfer case. Ensure there is full engagement in all gears and 4WD ranges. Check battery connections and electrical component operations. Test-drive vehicle.

**⚠WARNING**

Retorque all fasteners after 500 miles and after off road use. All body lift components should be visually inspected and fasteners retorqued during routine vehicle servicing.

**⚠CAUTION**

Performance Automotive Group does not recommend any particular wheel and tire combinations for use with its body lifts and cannot assume responsibility for the customer's choice of wheels and tires. Refer to your owner's manual for recommended tire sizes and warnings related to the use of oversized tires. Larger wheel and tire combinations increase stress and wear on steering and suspension components, which leads to increased maintenance and higher risk for component failure. Larger wheel and tire combinations also alter speedometer calibration, braking effectiveness, center of gravity, and handling characteristics. Consult an experienced local off road shop to find what wheel and tire combinations work best with your vehicle.

**NOTE**

All warranty information, instruction sheets, and other documents regarding the installation of this product must be retained by the vehicle owner. Information contained in the instructions and on the warranty card will be required for any warranty claims. The vehicle owner needs to understand the modifications made to the vehicle and how they affect vehicle handling and performance. Failure to provide the customer with this information can result in damage to the vehicle and severe personal injury.

# Kit Parts List

Qty. Description

## Kit 5583 & 5593

4 **Block** (3" x 2")  
 8 **Block** (3" x 3")  
 4 **Block** (crush)  
 2 **Bracket** (bumper, front)  
 1 **Bracket** (bumper, front, crush, left)  
 1 **Bracket** (bumper, front, crush, right)  
 2 **Bracket** (bumper, rear)  
 1 **Extension** (1" x 2", metal)  
 1 **Hose** (1" x 2")  
 1 **Hose** (1/2" x 11")  
 1 **Instruction** sheet  
 1 **Label** (logo)  
 1 **Label** (warning)  
 1 **Loctite®** (6ml bottle)

## Kit 5593

2 **Hose** (1/4" x 11")

**1 5583 (Bolt Pack)**  
 2 **Bolt** (1/2" x 4")  
 4 **Bolt** (12mm x 110mm)  
 1 **Bolt** (3/8" x 1-1/4")  
 2 **Bolt** (3/8" x 6")  
 4 **Bolt** (3/8" x 7")  
 2 **Bolt** (3/8" x 8")  
 1 **Extension** (steering)  
 2 **Nut** (1/2" Nylock)  
 6 **Nut** (3/8" Nylock)  
 8 **Washer** (1/2" USS)

## 1 5583 (Hardware Pack)

12 **Bolt** (7/16" x 1")  
 3 **Bolt** (8mm x 100mm)  
 3 **Bracket** (3" Z-shaped)  
 1 **Bracket** (3-hole)  
 4 **Bracket** (radiator)  
 2 **Clamp** (#10 hose)  
 2 **Clamp** (#28 hose)  
 2 **Extension** (shift lever)  
 8 **Nut** (1/4" Nylock)  
 12 **Nut** (7/16" Nylock)  
 3 **Spacer** (1/2" x 3")  
 12 **Washer** (1/4" SAE)  
 24 **Washer** (7/16" USS)  
 3 **Washer** (8mm)

Qty. Description

**1 5593 (Bolt Pack)**  
 2 **Bolt** (1/2" x 4")  
 4 **Bolt** (12mm x 110mm)  
 1 **Bolt** (3/8" x 1-1/4")  
 2 **Bolt** (3/8" x 6")  
 2 **Bolt** (3/8" x 7")  
 2 **Bolt** (3/8" x 7-1/2")  
 2 **Bolt** (3/8" x 8")  
 1 **Extension** (steering)  
 2 **Nut** (1/2" Nylock)  
 6 **Nut** (3/8" Nylock)  
 8 **Washer** (1/2" USS)

## 1 5593 (Hardware Pack)

4 **Bolt** (1/4" x 1")  
 12 **Bolt** (7/16" x 1")  
 3 **Bolt** (8mm x 100mm)  
 1 **Bracket** (2" Z-shaped)  
 3 **Bracket** (3" Z-shaped)  
 1 **Bracket** (3-hole)  
 4 **Bracket** (radiator)  
 4 **Clamp** (#10 hose)  
 2 **Clamp** (#28 hose)  
 3 **Clamp** (#36 hose)  
 1 **Extension** (5/8" x 3")  
 2 **Extension** (shift lever)  
 8 **Nut** (1/4" Nylock)  
 12 **Nut** (7/16" Nylock)  
 3 **Spacer** (1/2" x 3")  
 12 **Washer** (1/4" SAE)  
 24 **Washer** (7/16" USS)  
 3 **Washer** (8mm)

### NOTE

Depending on the vehicle configuration (automatic or manual transmission, 2WD or 4WD, cab length, bed length, etc.), some parts may not be used.