



3651 N Highway 89 • Chino Valley, AZ 86323
(928) 636-7080 • www.p-a-g.net

DODGE RAM
GASOLINE ENGINES
3" BODY LIFT
INSTALLATION INSTRUCTIONS
2003-2005 1500
2005 2500, 3500 (2WD ONLY)
KIT# 60123

⚠ WARNING

Installation of a Performance Automotive Group body lift kit will change the vehicle's center of gravity and handling characteristics both on- and off-road. You must drive the vehicle safely! Extreme care must be taken to prevent vehicle rollover or loss of control, which could result in serious injury or death. Avoid sudden sharp turns or abrupt maneuvers and always make sure all vehicle occupants have their seat belts fastened.

⚠ WARNING

Before you install this kit, read and understand all instructions, warnings, cautions, and notes in this instruction sheet and in the vehicle owner's manual.

⚠ CAUTION

Proper installation of this kit requires knowledge of the factory recommended procedures for removal and installation of original equipment components. We recommend that the factory shop manual and any special tools needed to service your vehicle be on hand during the installation. Installation of this kit without proper knowledge of the factory recommended procedures may affect the performance of these components and the safety of the vehicle. We strongly recommend that a certified mechanic familiar with the installation of similar components install this kit.

⚠ WARNING

DO NOT combine suspension, body, or other lift devices. Use of vehicle with combined lifts may result in unsafe and/or unexpected handling characteristics.

⚠ WARNING

This kit should only be installed on a vehicle that is in good working condition. Before you install the kit, thoroughly inspect the vehicle for corrosion or deformation of the sheet metal around the factory body mounts. If the vehicle is suspected to have been in a collision or misused, do not install this kit. Off-road use of your vehicle with this kit installed may increase the stress applied to the factory body mounts. We do not recommend that any vehicle with a body lift kit installed be involved in any extreme off-road maneuvers such as jumping. Failure to observe this warning may result in serious personal injury and/or severe damage to your vehicle.

⚠ WARNING

Many states and municipalities have laws restricting bumper heights and vehicle lifts. Consult state and local laws to determine if the changes you intend to make to the vehicle comply with the law.

⚠ WARNING

The installation of larger tires may reduce the effectiveness of the braking system.

⚠ WARNING

Always wear eye protection when operating power tools.

⚠ WARNING

Before you install this kit, block the vehicle tires to prevent the vehicle from rolling.

⚠ WARNING

Accidental deployment of the air bag can result in serious personal injury or death. To avoid accidental deployment during installation of the kit, the Supplemental Restraint System (SRS, or airbag) must remain deactivated. Do not allow anyone near the airbag during installation. Refer to the factory service manual or owner's manual for the recommended procedure to disable the SRS. After you install the kit, reactivate the SRS before driving the vehicle.

NOTE

Performance Automotive Group recommends using the Loctite® supplied in the kit on the threads of all kit nuts and bolts unless specified otherwise in these instructions.

Before Starting Installation

NOTE

Kit parts are prefaced by the word kit and appear in **bold** print.

1. Carefully read all warnings and instructions completely before beginning.
2. Verify all parts have been received in this kit by checking the parts list at the end of this document.

NOTE

If parts are missing from kit, please be prepared to provide the following information:

1. **Name** of purchase location
2. **Bar Code** on side of box
3. **Date** above bar code
4. **Date** inside box cover
5. **Inspector #** from inside box cover

3. **Only install this kit on the vehicle for which it is specified.** If anytime during the installation you encounter something different from what is outlined in the instructions, call technical support at (928) 636-7080.
4. Special tools needed:
 - a. Welder or access to a professional welding shop.
 - b. Die grinder or similar tool capable of cutting metal.
5. Park vehicle on a clean, dry, flat, level surface and block tires so vehicle cannot roll in either direction.

Engine Compartment

1. Disconnect both battery cables. Disconnect negative cable first, then positive cable.

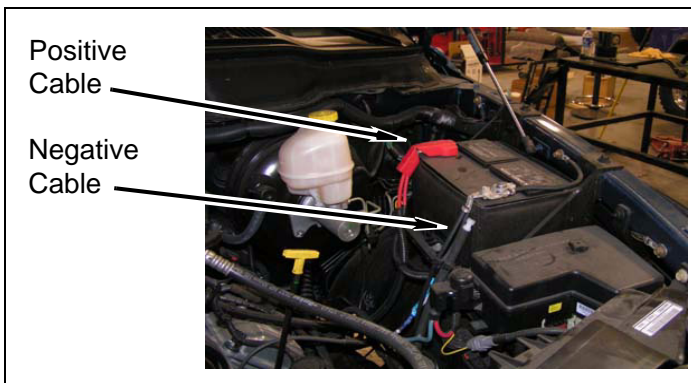

2. Airbag Fuse

NOTE

The location of the airbag fuse may vary; check the owner's manual.

- a. Remove fuse cover.
- b. Remove airbag fuse.

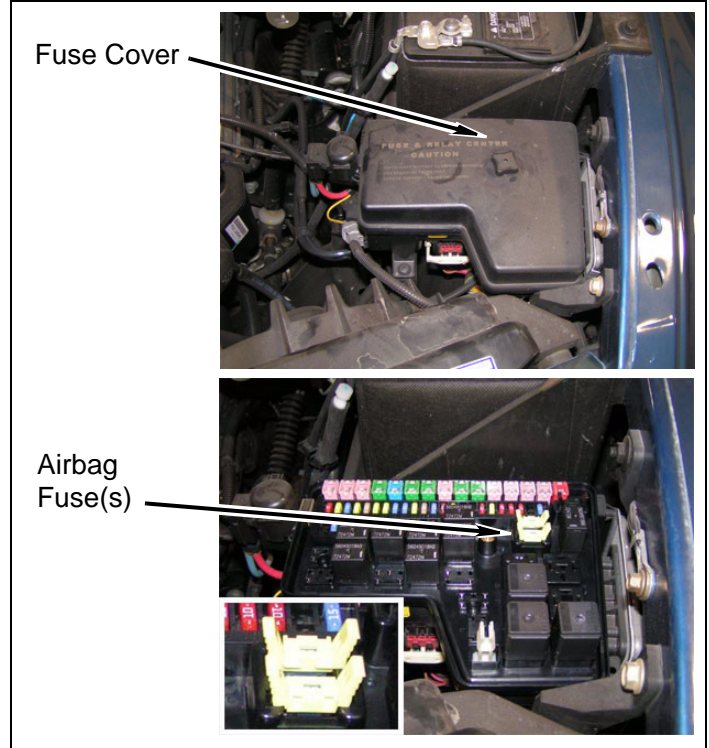

Prepare to Install Kit

Measurements

1. Measure and record distance between front bumper and fenders.

Driver Side _____ Passenger Side _____

2. Measure and record distance between rear bumper and bed

Driver Side _____ Passenger Side _____

3. Measure and record distance between cab and bed.

Driver Side _____ Passenger Side _____

Front of Vehicle

1. Front bumper

- a. Disconnect fog light harness at driver side of front bumper and pull connector off of front bumper, if equipped.

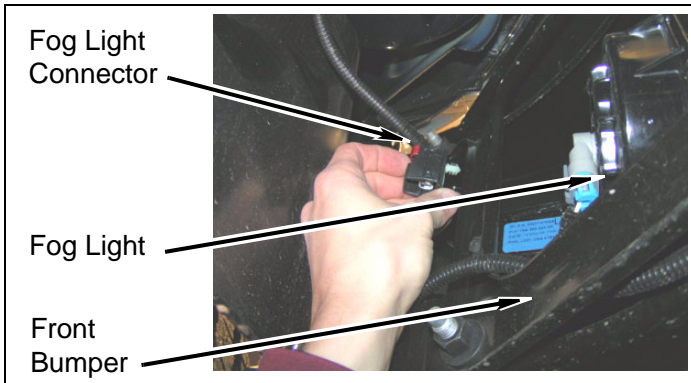

- b. Remove four nuts, four bolts attaching front bumper to frame.

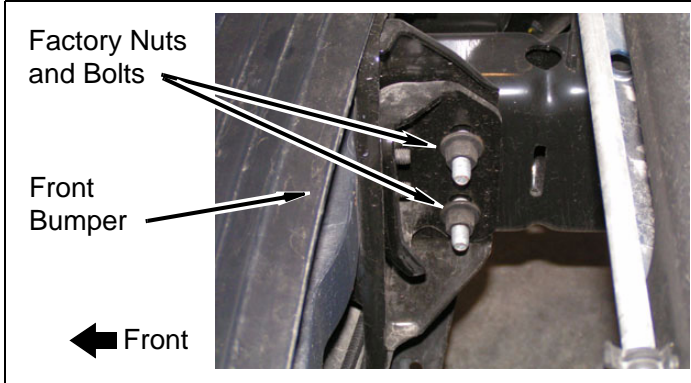

- c. Remove front bumper.

Engine Compartment

1. 2003 Models: Airbox

- a. Release four clips attaching airbox cover and loosen clamp on hose to throttle body.

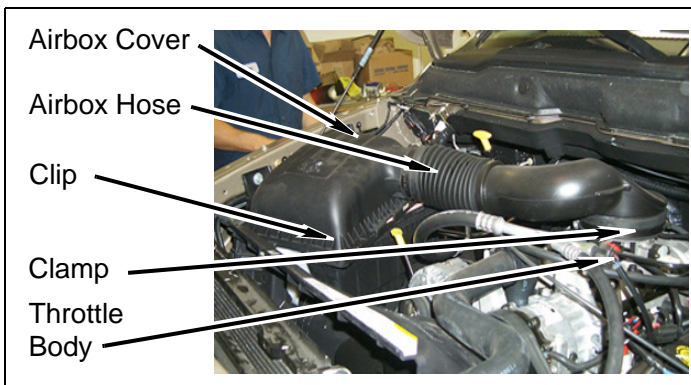

- b. Remove airbox cover and hose from vehicle.

2. 2004-2005 Models: Airbox

- a. Release four clips attaching airbox cover. Remove breather hose from airbox cover. Loosen airbox hose at intake housing.

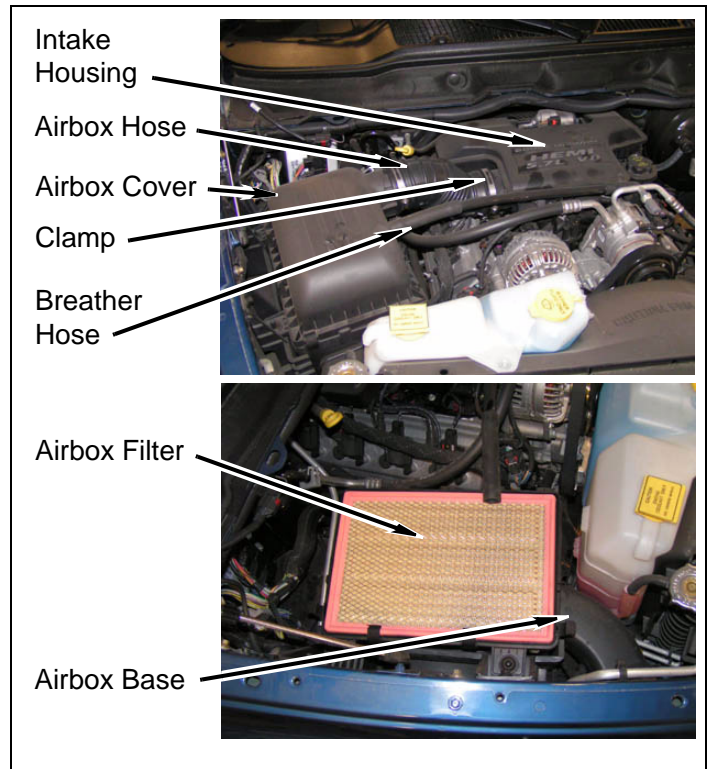

- b. Remove airbox cover, base and filter from vehicle.

3. 2003 Models: Radiator overflow and window washer reservoirs

- a. Remove bolts attaching radiator overflow reservoir to fan shroud.

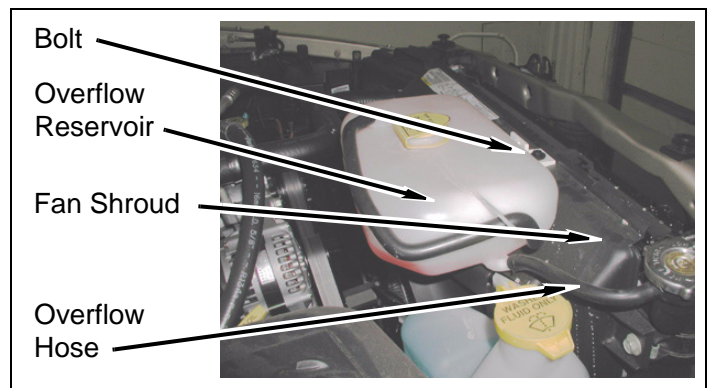

- b. Disconnect and cap off overflow hoses.

- c. Remove radiator overflow reservoir from vehicle.

d. Remove two electrical connectors from window washer reservoir.

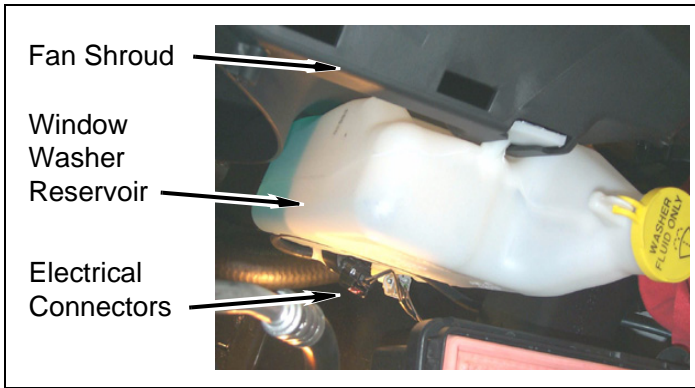

c. Remove two electrical connectors from reservoirs.

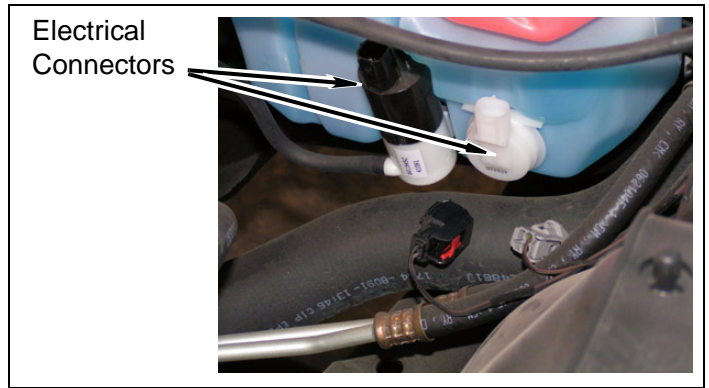

e. Remove window washer reservoir from fan shroud. Position window washer reservoir off to side of engine compartment.

d. Remove radiator overflow and window washer reservoirs from fan shroud.

4. 2004-2005 Models: Radiator overflow and window washer reservoirs

5. Fan shroud

a. Remove bolts attaching radiator overflow and window washer reservoirs to fan shroud.

a. Remove bolts attaching fan to fan clutch. Pull fan towards engine and rest fan on fan clutch shaft.

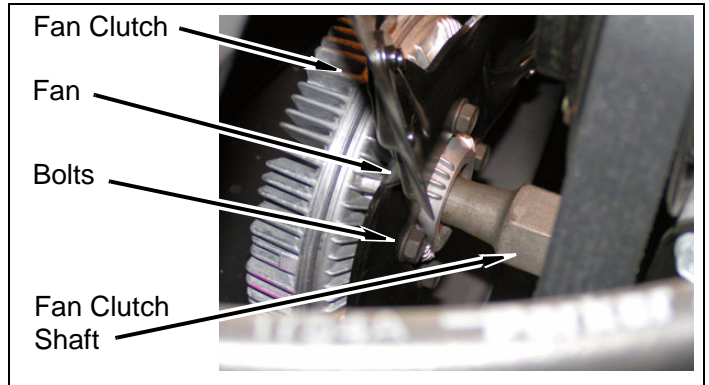
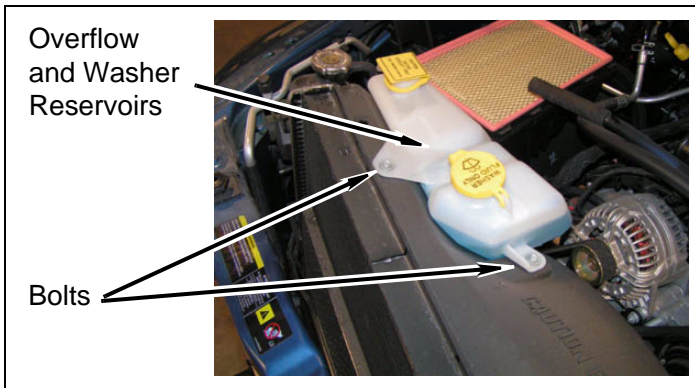

b. Disconnect and cap off overflow and washer hoses.

b. Remove power steering lines and clip from bottom of fan shroud.

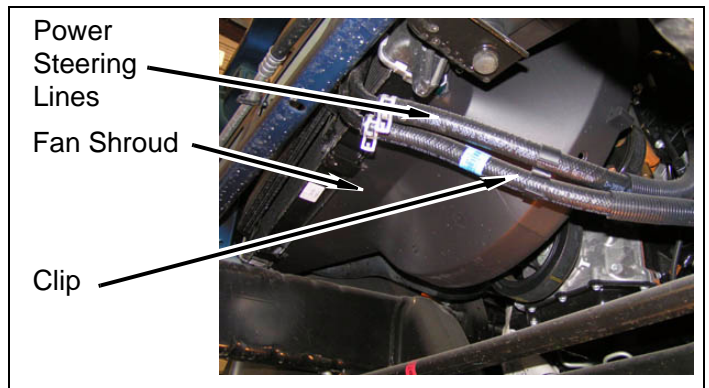
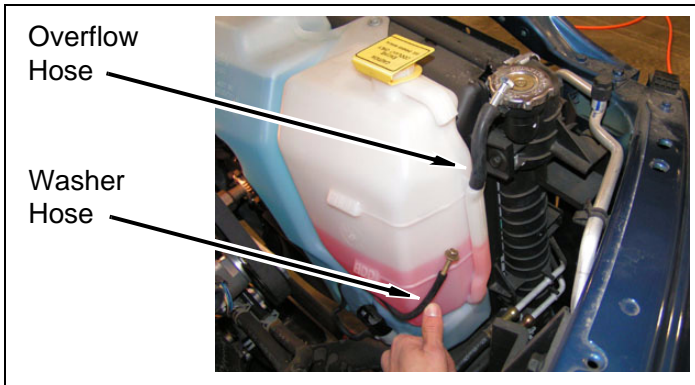

- c. Remove two bolts attaching fan shroud to radiator.

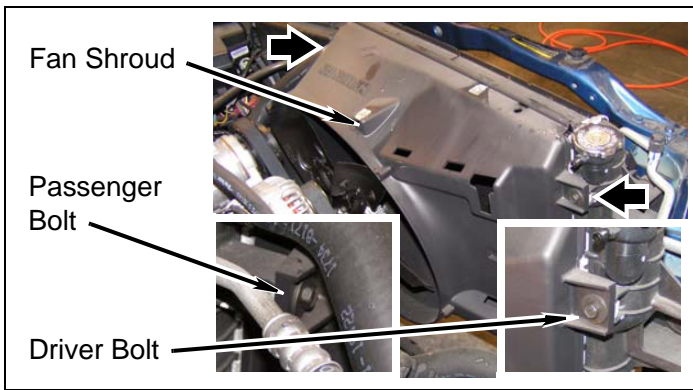

NOTE
It may be necessary to hold upper radiator hose out of way to avoid fan shroud contact during removal.

CAUTION
DO NOT DAMAGE radiator while removing fan shroud.

6. Automatic transmission cooler

- a. Remove clip and two automatic transmission cooler lines from engine block.

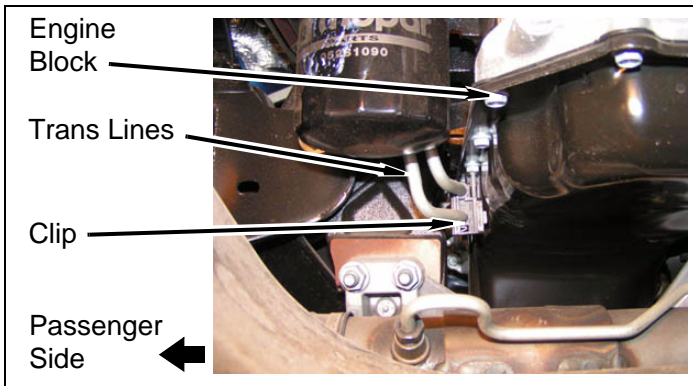

7. Steering Shaft

WARNING
Accidental deployment of the air bag can result in serious personal injury or death. To avoid accidental deployment during installation of the lift kit, the Supplemental Restraint System (SRS, or airbag) must remain deactivated. Do not allow anyone near the airbag during installation. Refer to the factory service manual or owner's manual for the recommended procedure to disable the SRS. After kit installation, the SRS must be reactivated before driving the vehicle.

CAUTION
If the following step is not performed, the airbag clock-spring could be damaged. Do not turn the steering wheel while the steering shaft is disconnected.

- a. Strap steering wheel to prevent accidental movement.
- b. Mark intermediate shaft in relation to rack and pinion as shown.

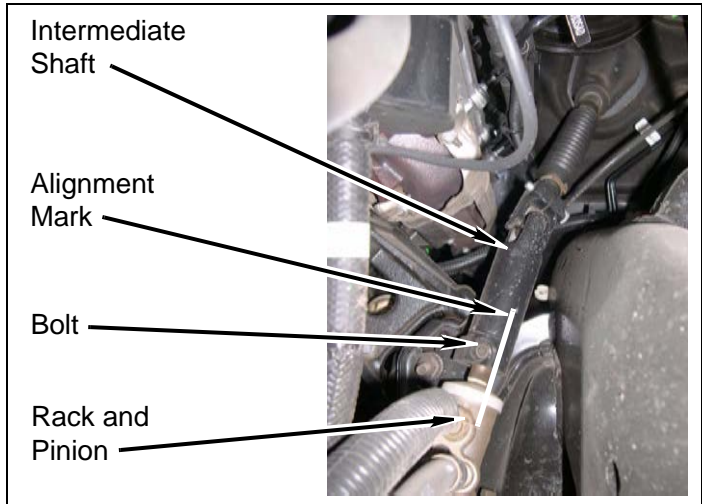

- c. Remove bolt and intermediate shaft from rack and pinion. Slide intermediate shaft up to separate from rack and pinion.

NOTE
Intermediate shaft may not separate from rack and pinion until cab is lifted.

- 8. 2003 Models:** Remove nut and ground strap from stud located on passenger side firewall

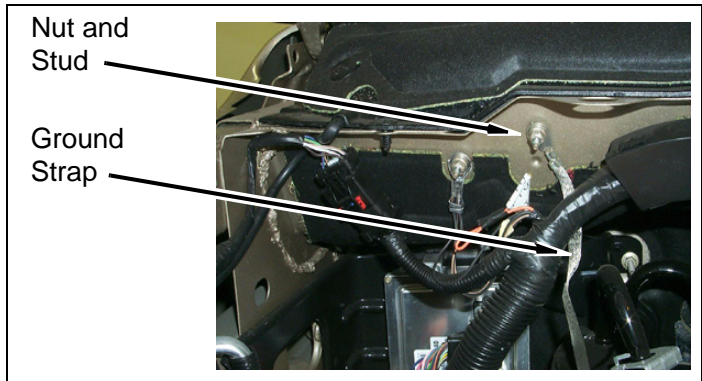

- 9. Remove two heater hoses from clip on passenger side of firewall.**

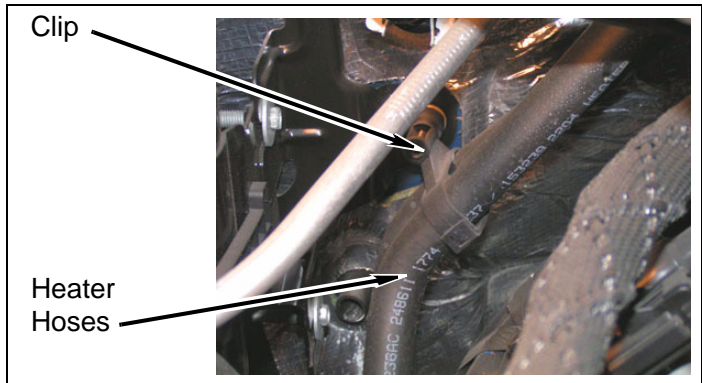

10. Remove brake sensor harness from passenger and driver fender wells.

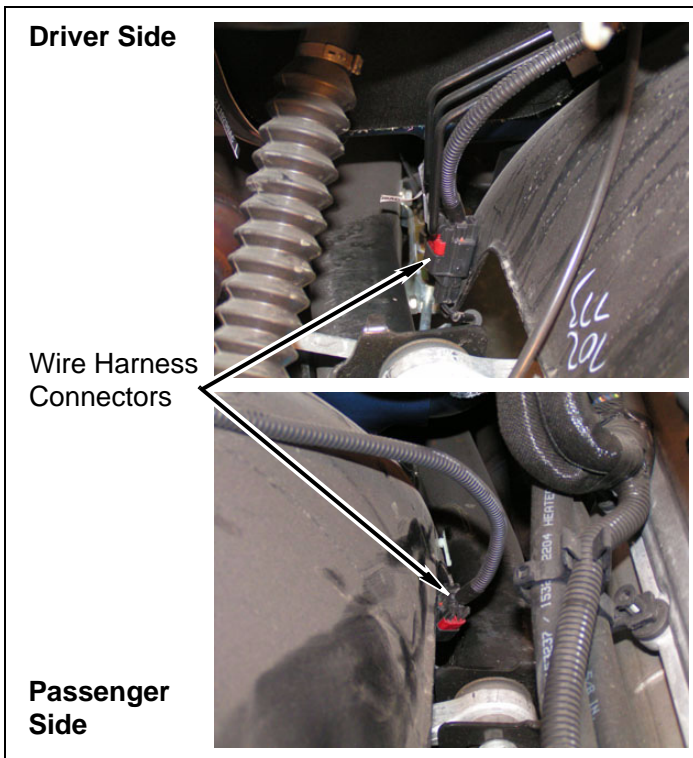

c. Remove bolts attaching brake line brackets from driver side.

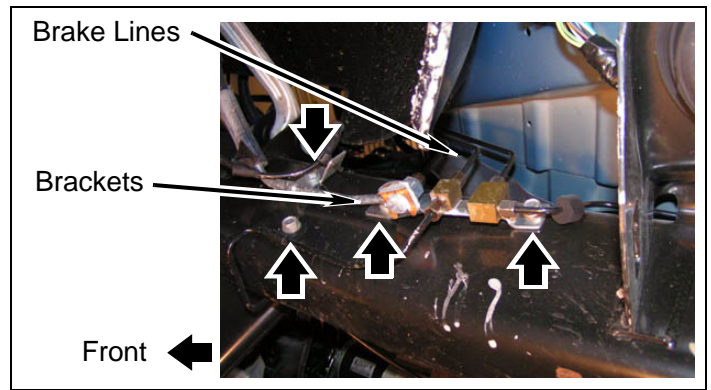

d. Remove bolt securing ground strap in front of driver side wheel well.

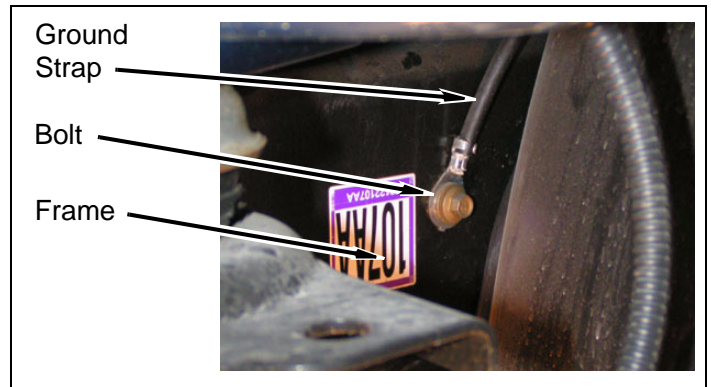

e. Remove harness from body mount bracket.

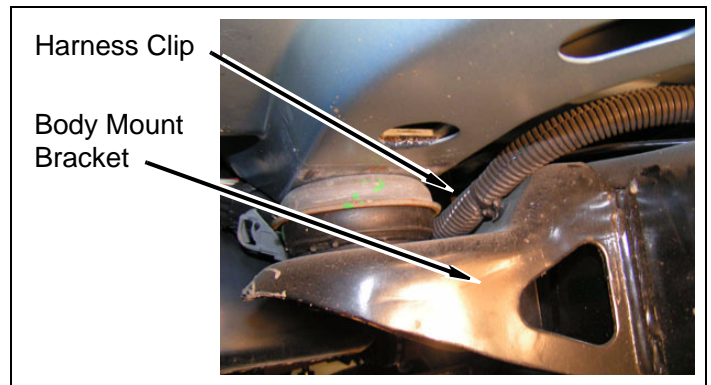

NOTE
The following procedures applies ONLY to automatic transmissions.

Underside of Vehicle

1. Wire harnesses and brake lines

a. Remove clip from driver side frame.

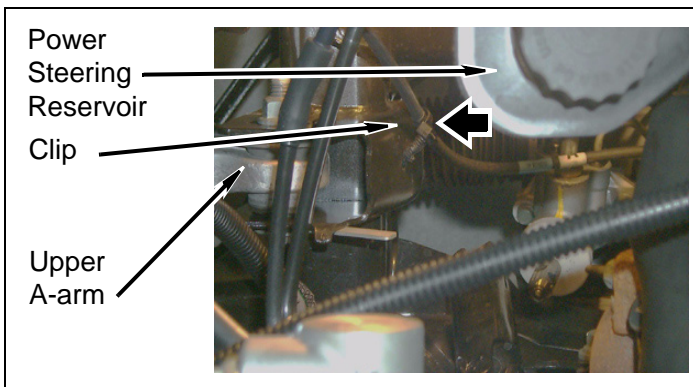

b. **2003-2004 Models:** Remove brake lines from retaining clip on driver and passenger front inner fender wheel well.

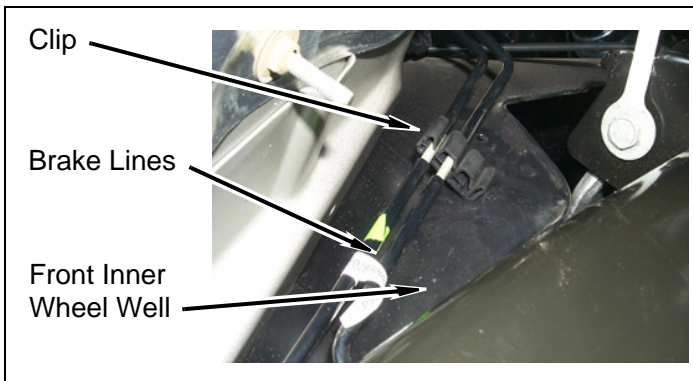

f. **Automatic transmission models:** Remove transmission shifter cable from clip on frame.

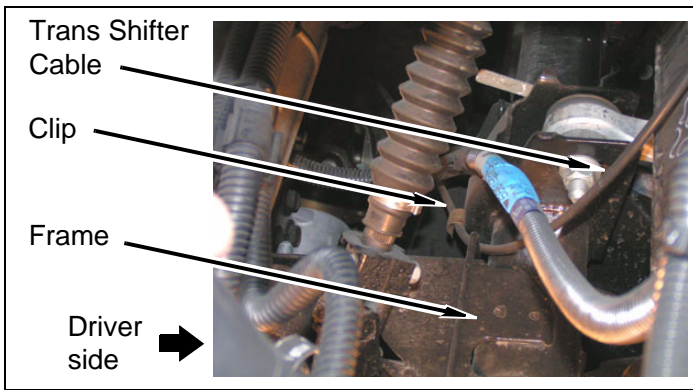

g. **Automatic transmission models:** Remove clip, two harnesses, hose and three hard lines from frame driver side.

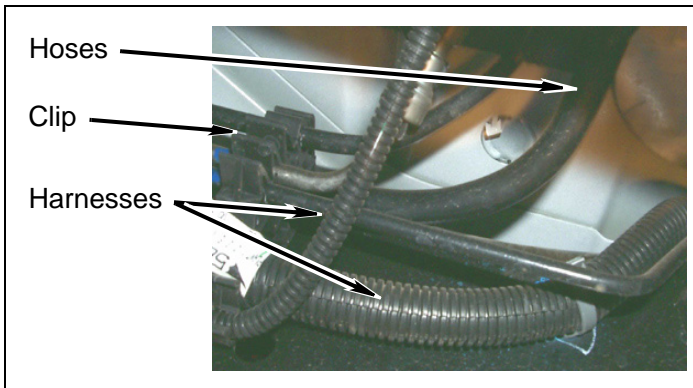

h. **Automatic transmission models:** Remove transmission wire harness from frame mount clip.

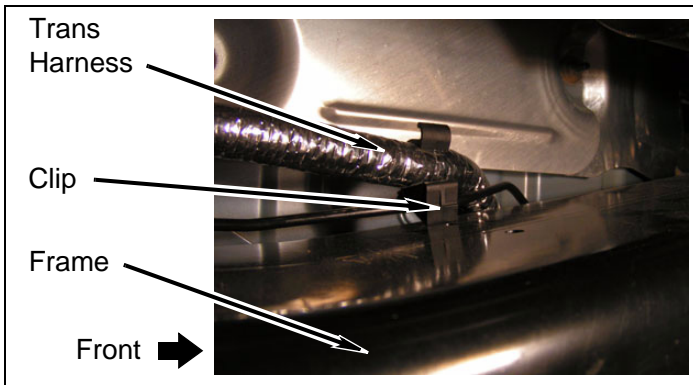

2. Parking brake cable

- a. Pull slack into parking brake cable. Attach locking pliers to parking brake cable to allow slack, if necessary.
- b. Use expanding pliers to disconnect parking brake cable from junction.

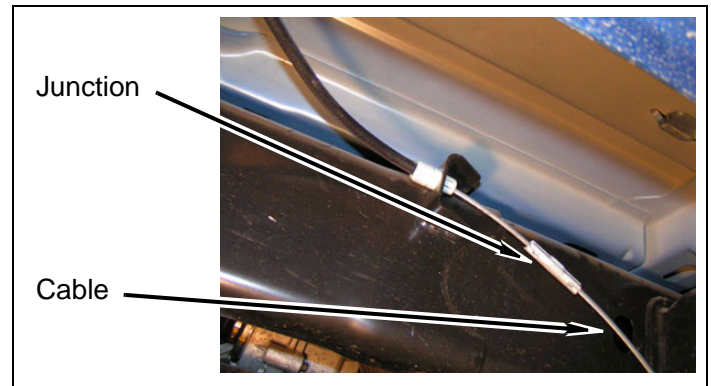

- c. Remove parking brake cable from driver side frame mount.

Inside of Vehicle

1. Manual transmission shift lever

- a. Shift transmission into neutral.
- b. Remove transfer case shift lever boot from center console and slide boot up shift lever.

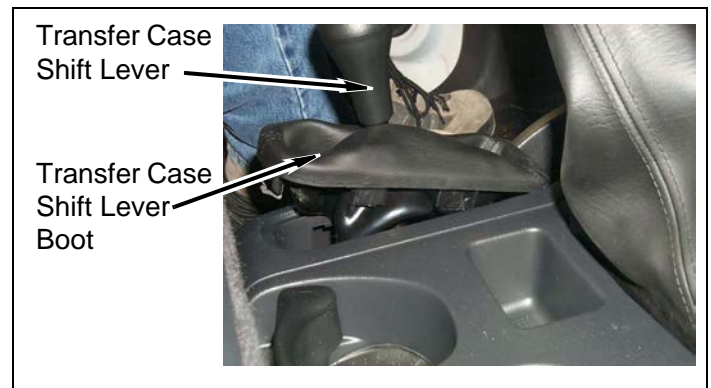

c. Unscrew transmission shift lever from shift tower.

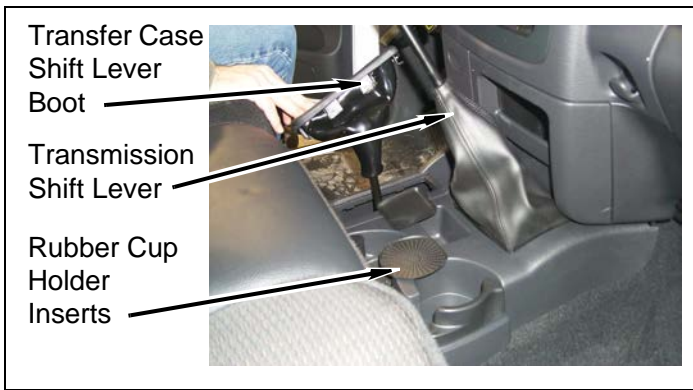

NOTE

Some of the bolts securing the center console to the floor are underneath the cup holder rubber inserts.

d. Remove bolts attaching center console to floor.

e. Remove center console from floor by feeding transfer case shift boot through opening in console.

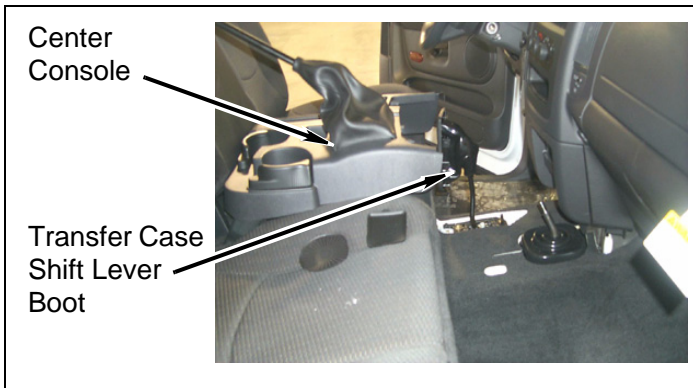

f. Remove six bolts attaching shift lever boot seal to floor.

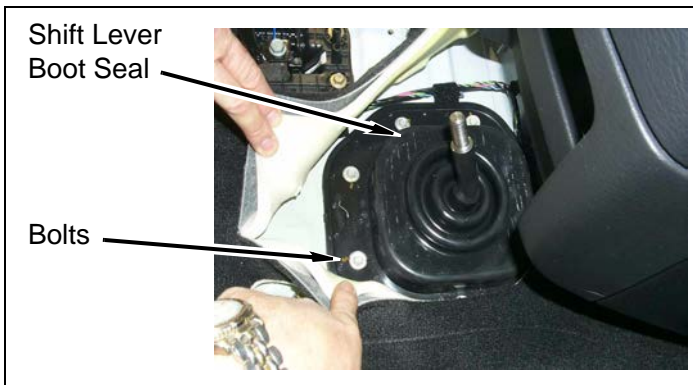

g. Remove rubber cover from shift tower.

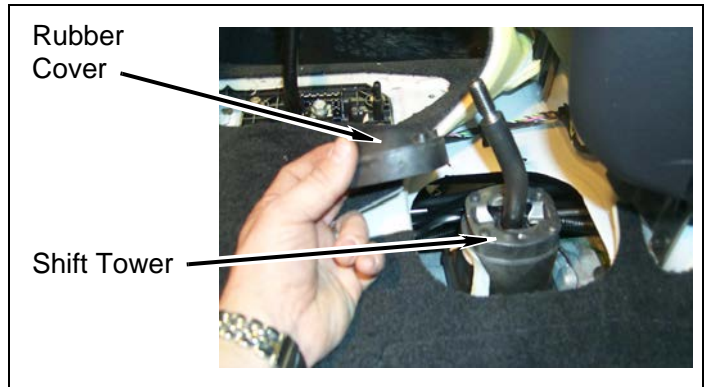

h. Remove four Torx bolts from shift tower mounting plate.

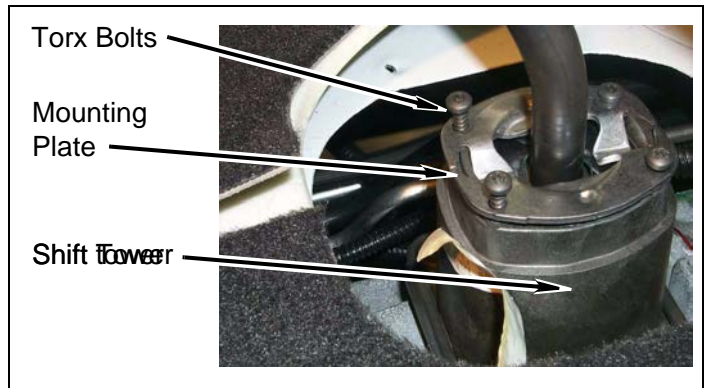

i. Remove shift lever from shift tower.

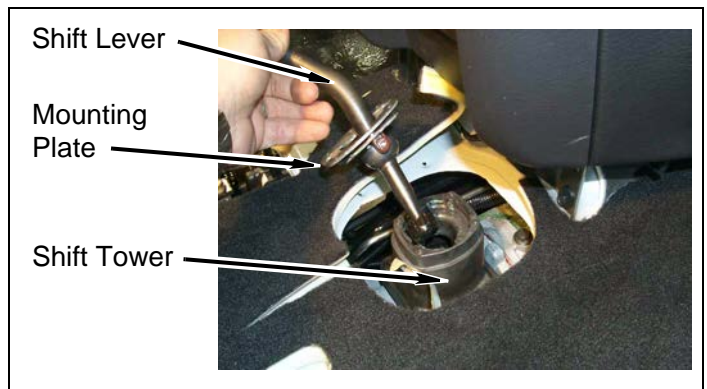

- j. Remove two plastic shift tabs, plastic ball, shim and mounting plate from shift lever.

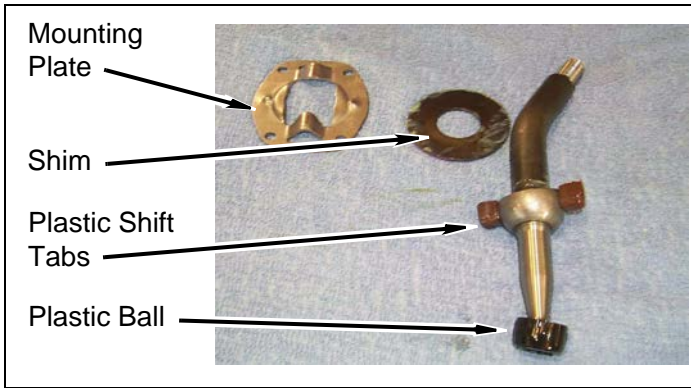

NOTE
The following procedures apply only to vehicles with manual transfer cases.

2. Manual transfer case

- a. Move transfer case shift lever into 2H position.
- b. Remove trunnion and shift rod from 4WD shift lever and transfer case input lever.

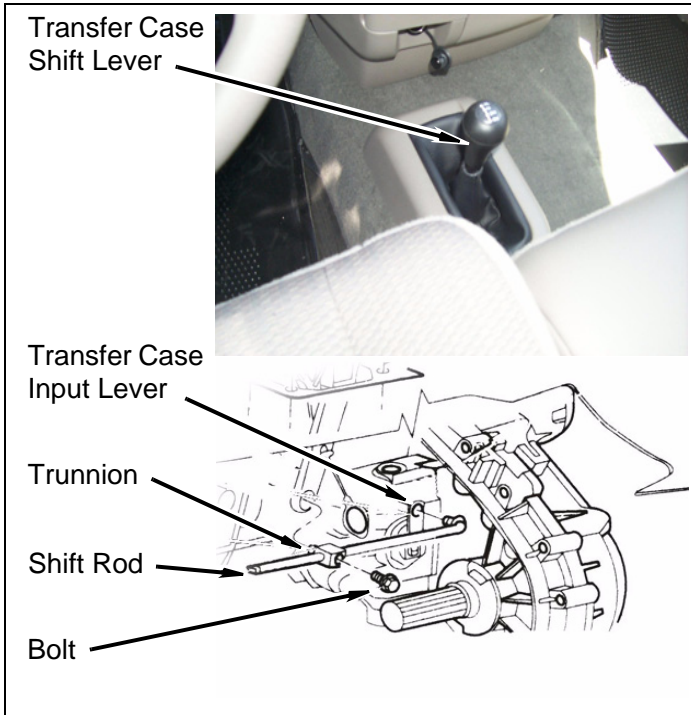

Rear of Vehicle

1. Fuel filler

⚠ WARNING
Use extreme caution when working near fuel line(s) and fuel tank(s). Clean up spilled fuel immediately. Any spark could cause an explosion or fire resulting in serious personal injury and/or property damage.

- a. Remove fuel cap from fuel filler.
- b. Remove three bolts attaching fuel filler to body.

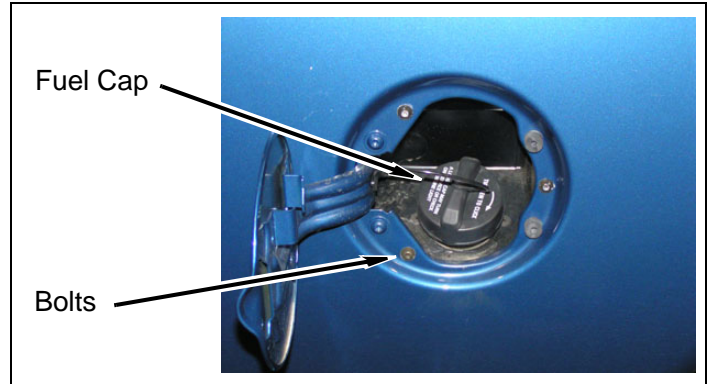

2. Ground strap

- a. Remove bolt and ground strap from bed or cab.

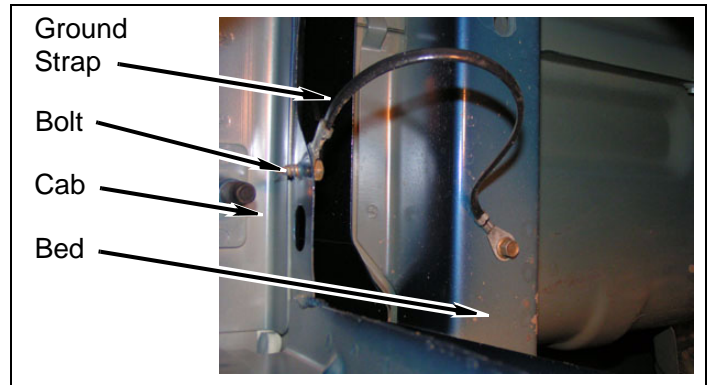

3. Rear bumper

a. Remove wire harness connectors from rear bumper.

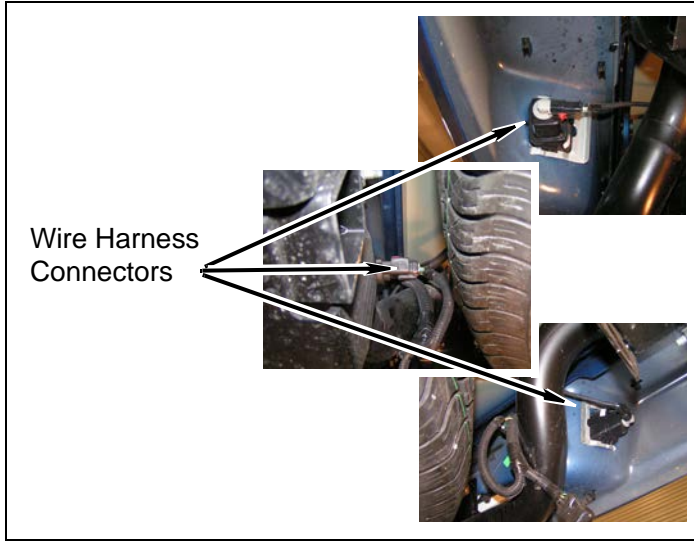

b. Remove two screws and license plate.

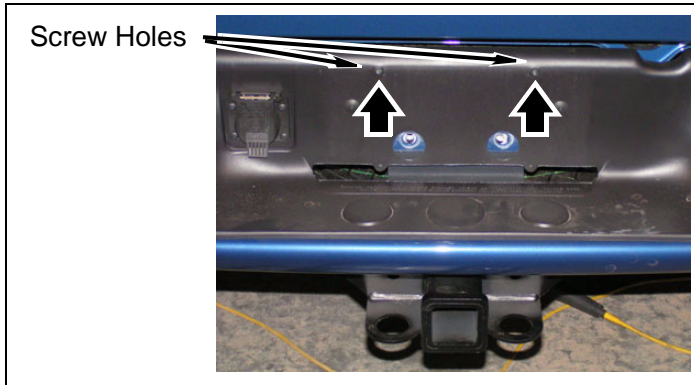

c. Remove two bolts attaching bumper bracket to bed.

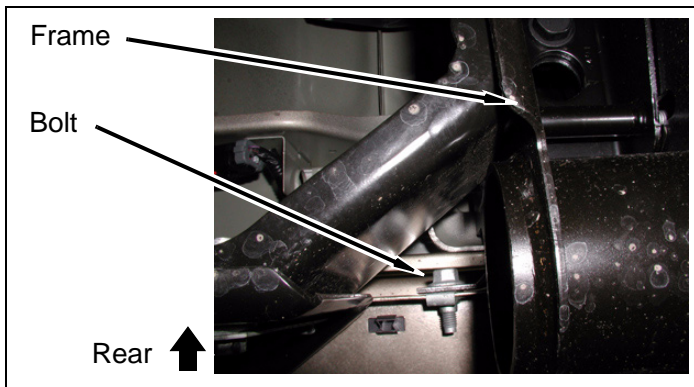

d. Remove two bolts from rear bumper and trailer hitch, if equipped.

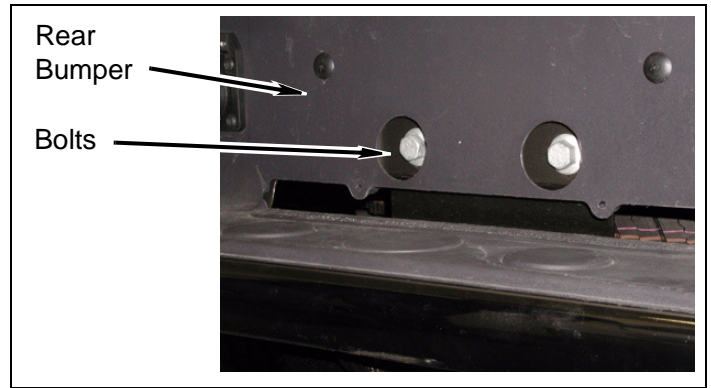

e. Remove four nuts and double bolt fasteners attaching bumper to bumper brackets.

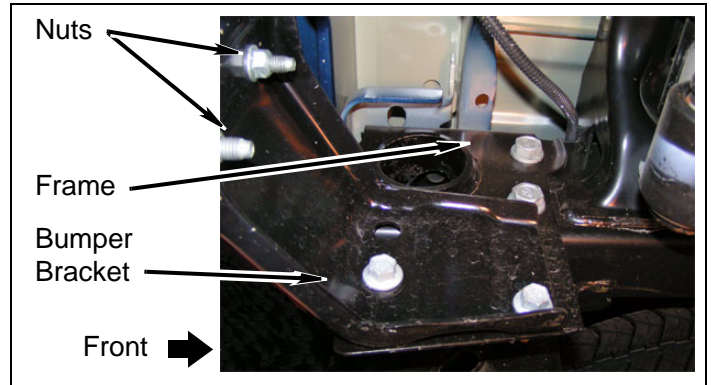

f. Remove rear bumper.

g. Remove four nuts and double bolt fasteners attaching bumper brackets to frame.

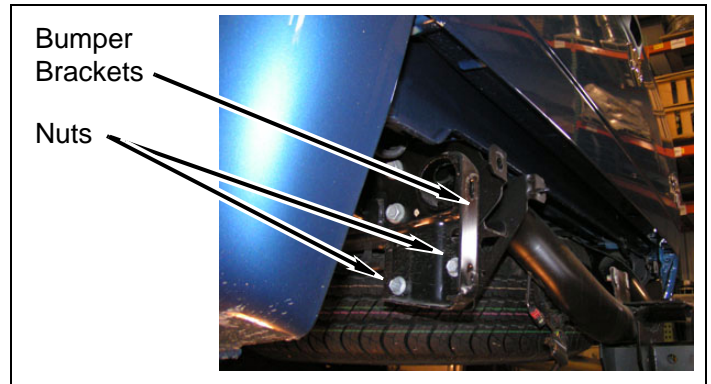

h. 2003-2004 Models: Remove two nuts and bolts attaching bumper brackets to trailer hitch.

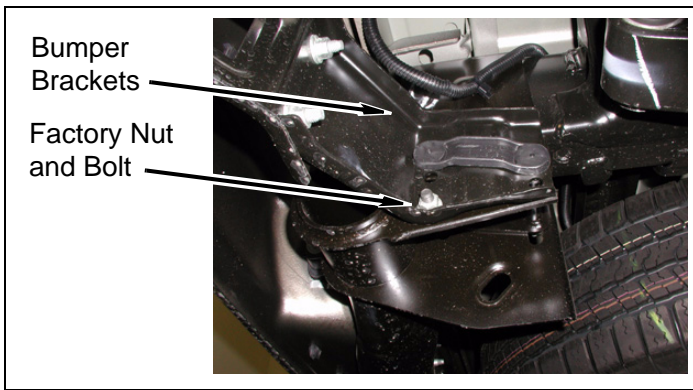

i. Remove bumper brackets from frame.

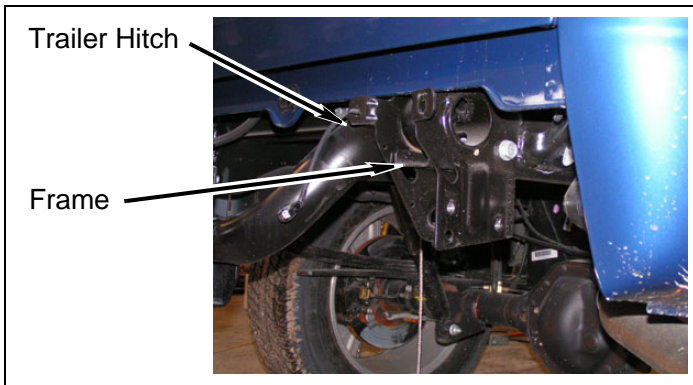

4. Spare tire winch

- a. Lower spare tire to ground and remove (see owner's manual for procedure).
- b. Remove retaining clip and ratchet tube from spare tire winch mechanism.

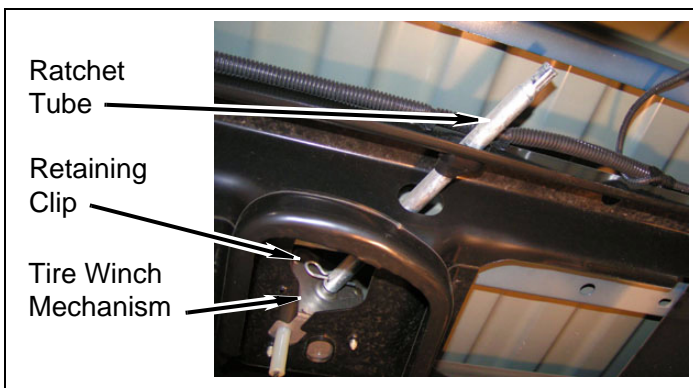

c. Remove plastic ratchet tube guide from cross-member.

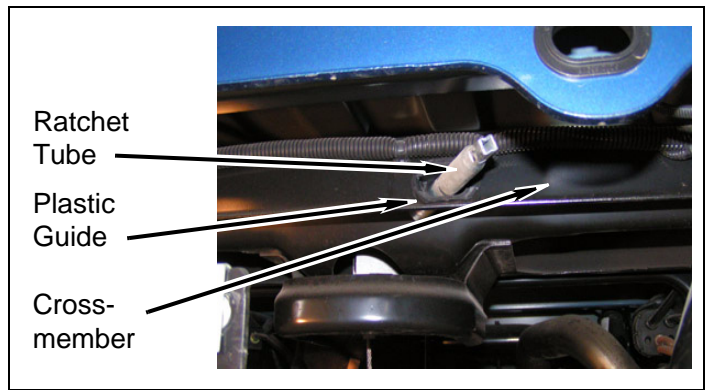

Install Kit

Cab

1. Prepare to lift cab from frame

- a. Loosen, but **DO NOT REMOVE**, cab mounting bolts on driver side.

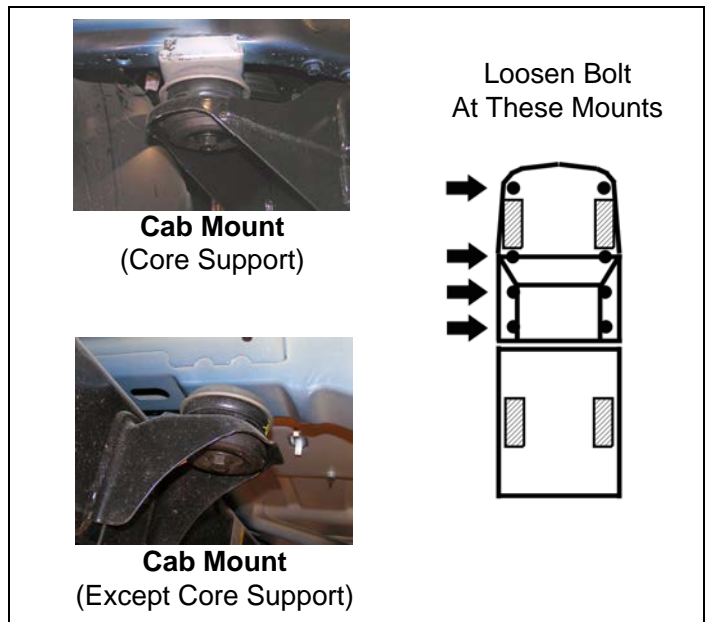

NOTE

The number of cab mounting bolts may vary with the length of the cab.

- b. Remove bolt and lower bushing from each cab mount on passenger side.

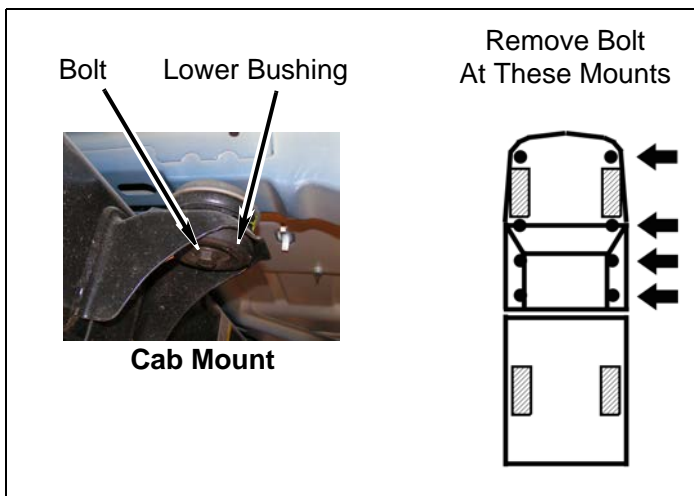

- b. Place **kit blocks** (3" x 3") on metal cups and upper bushings on each cab mount.

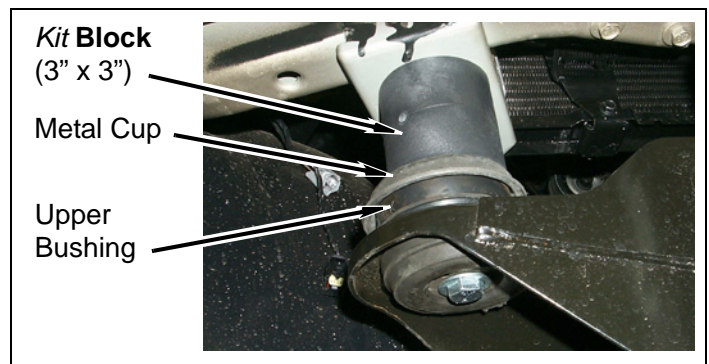

- c. Lower cab onto **kit blocks** (3" x 3").

- d. Install lower bushing and a **kit bolt** (12mm-1.75 x 180mm) on each cab mount. **DO NOT TIGHTEN.**

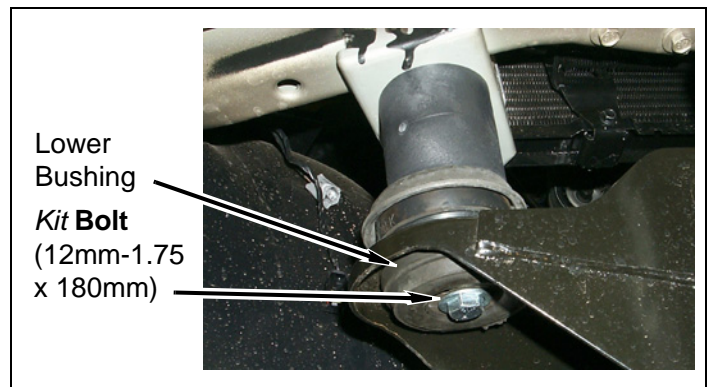

3. Cab driver side

- Repeat previous steps on driver side of cab.
- Set cab-to-bed spacing according to previous measurement.
- Remove each **kit bolt**, one at a time, and apply a few drops of **kit Loctite®** to threads. Install **kit bolt**, **kit washer** (7/16" USS), and lower bushing. Tighten **kit bolts** to **55 ft. lbs.**

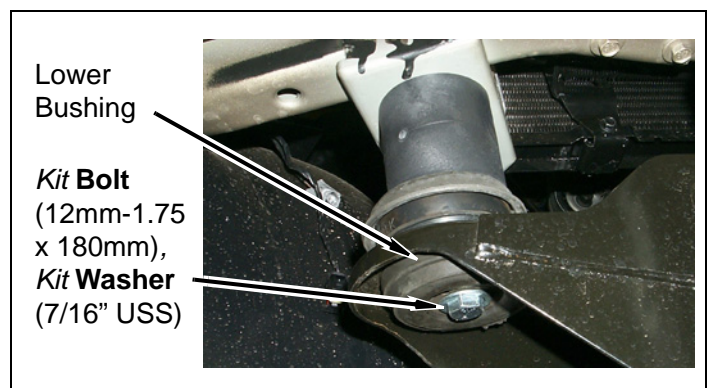

⚠ WARNING

Use extreme caution when lifting body from frame. To prevent serious personal injury, ensure the lifting device is securely placed. Keep your hands out from between the body and frame.

⚠ CAUTION

Continually check hoses, wires, lines, etc. to be sure that everything is flexing properly and not binding, or damage to the vehicle could result. Be especially careful of the a/c hoses at the fire wall, the belt pulley, and at the core support. Ensure brake lines stretch while lifting. Bending the lines to gain ample slack may be necessary. Be extremely careful not to kink the lines.

2. Cab passenger side

- Position a hydraulic jack and a wood block under passenger side of cab (under the body seam). Slowly lift cab just enough to install a **kit block** on top of factory upper bushing.

⚠ WARNING

The **kit blocks** must be installed in addition to the factory upper and lower bushings. Installing the **kit blocks** without the factory upper and lower bushings could result in damage to the vehicle or serious personal injury.

Bed

1. Prepare to lift bed from frame

- a. Loosen, but DO NOT REMOVE, bed mounting bolts on driver side.

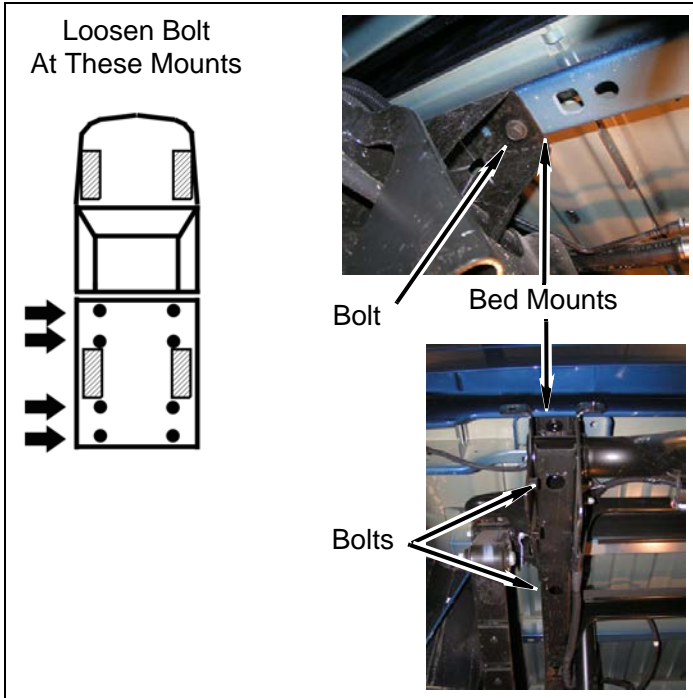

NOTE
The number of bed mounting bolts may vary with the length of the bed.

2. Remove bolt from each bed mount on passenger side.

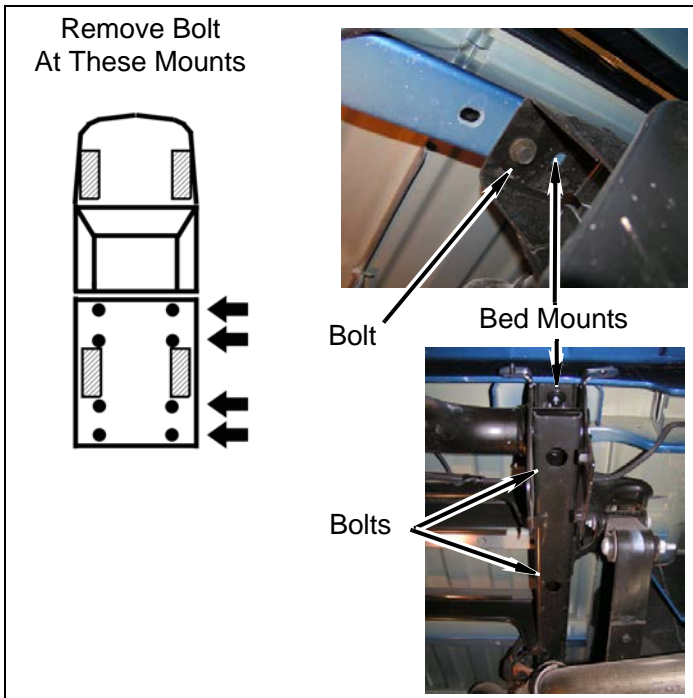

WARNING
Use extreme caution when lifting the bed from the frame. To prevent serious personal injury, ensure the lifting device is securely placed. Keep your hands out from between the bed and frame.

CAUTION
To prevent damage to the vehicle while lifting the bed, continually check hoses, wires, brake lines, etc. to ensure everything is flexing properly and not binding. Ensure clearance between bed and cab is maintained.

3. Bed passenger side

- a. Using a hydraulic jack and a wood block, slowly lift passenger side of bed a little more than 3".
- b. Place a *kit block* (3" x 3") rear frame mount.

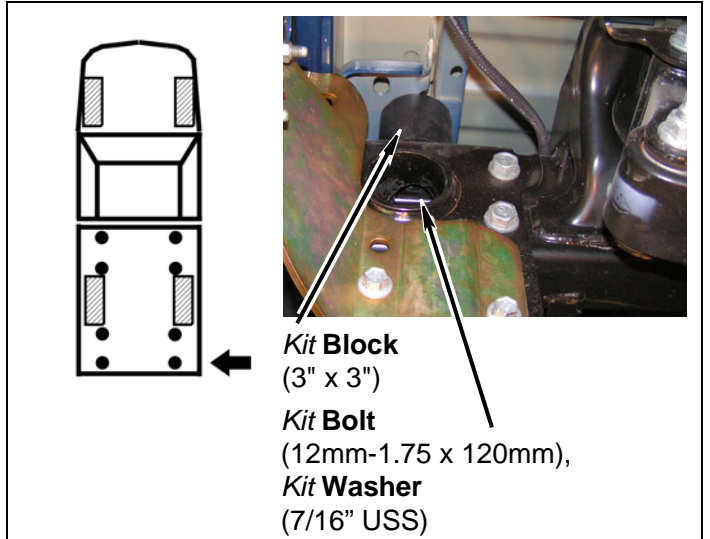

- c. Place *kit blocks* (3" x 3") on two (or three) other frame mounts.

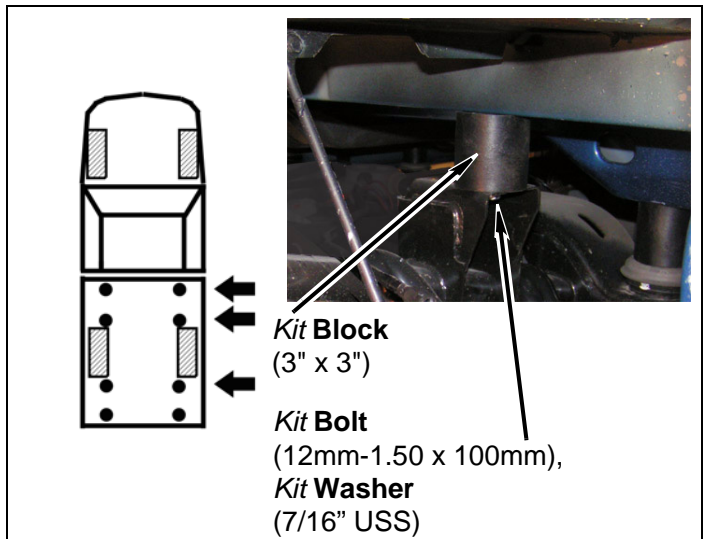

- d. Lower bed onto *kit blocks*.

- e. At rear bed mount, install **kit bolt** (12mm-1.75 x 120mm) and **kit washer** (7/16" USS). DO NOT TIGHTEN.
- f. At each other bed mount, install **kit bolt** (12mm-1.50 x 100mm) and **kit washer** (7/16" USS). DO NOT TIGHTEN.
- g. Repeat previous steps on driver side of bed.
- h. Set bed-to-cab spacing according to previous measurement.
- i. Remove each **kit bolt**, one at a time, and apply a few drops of **kit Loctite®** to threads. Install **kit bolt** with **kit washer** (7/16" USS). Tighten **kit bolts** to 55 ft. lbs.

- d. Turn **kit bracket** (spare tire winch) toward front of vehicle and slide spare tire winch cable through slot in **kit bracket** (spare tire winch).

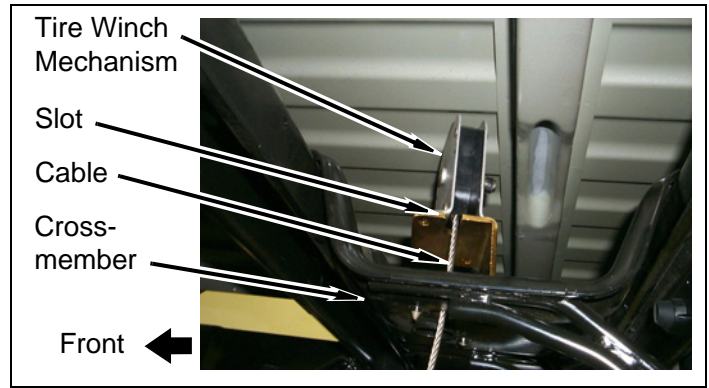

- e. Install factory passenger side bolt and tighten both passenger and driver side bolt.
- f. Install spare tire winch to **kit bracket** (spare tire winch) with two **kit bolts** (1/4"-20 x 1"), four **kit washers** (1/4" SAE) and two **kit nuts** (1/4"-20 Nylock). Tighten.

Rear of Vehicle

1. Spare tire winch

- a. Remove two bolts and spare tire winch from crossmember.

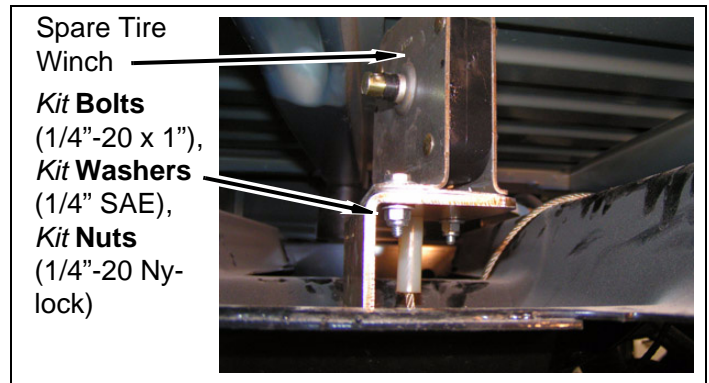
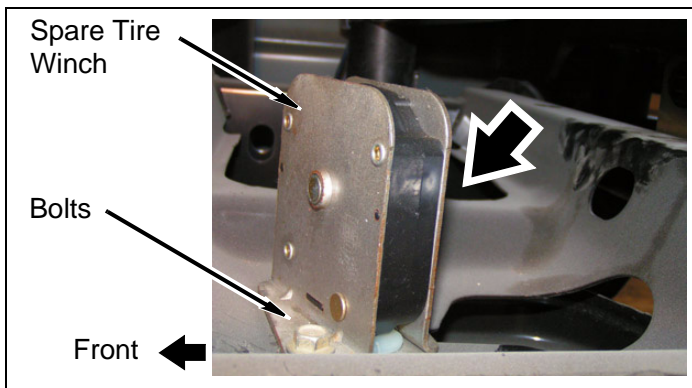

- b. Install **kit bracket** (spare tire winch) on cross-member and locate with factory driver side bolt.

- g. Remove two wire loom clips securing wire harness to crossmember.

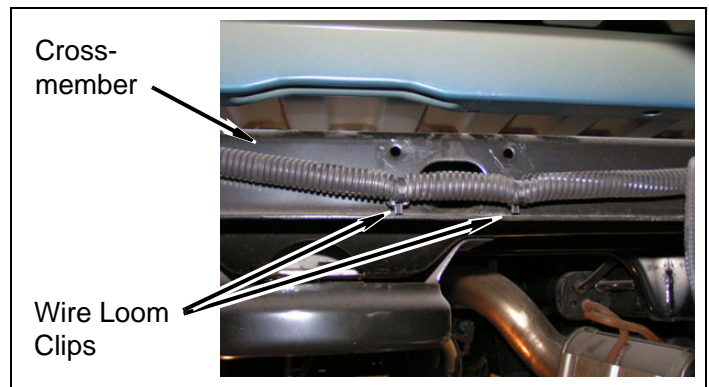
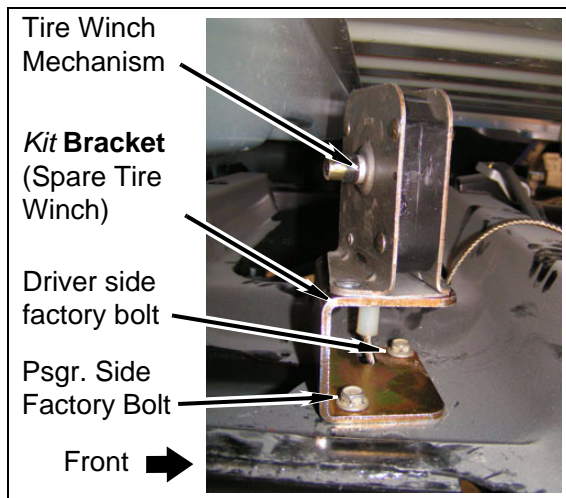

- c. Install spare tire winch through hole in cross-member. Install spare tire winch on **kit bracket** (spare tire winch).

- h. Install **kit bracket** (spare tire ratchet tube) to crossmember with two **kit bolts** (1/4"-20 x 1"), four **kit washers** (1/4" SAE) and two **kit nuts** (1/4"-20 Nylock). Install plastic ratchet tube guide into **kit bracket** (spare tire ratchet tube).

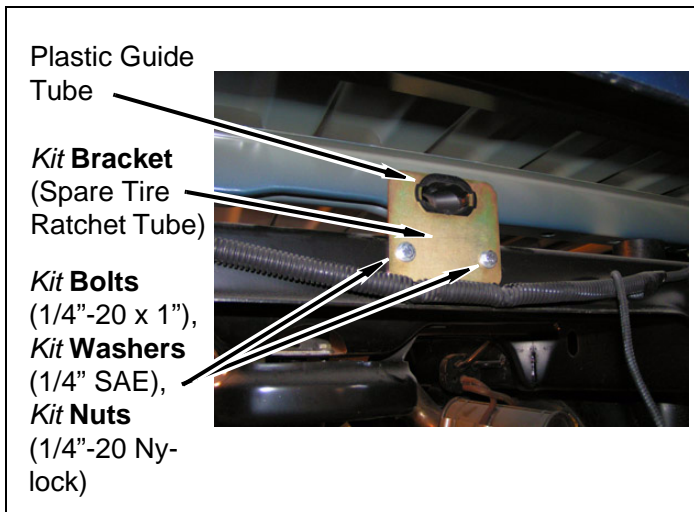

- i. Install ratchet tube on spare tire winch with retaining clip.

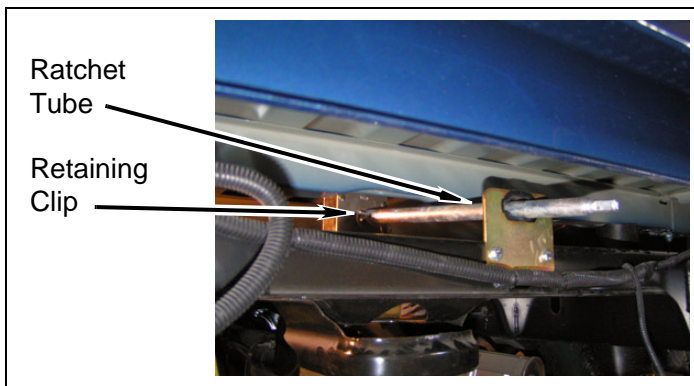

- j. Secure wire harness to crossmember with **kit tie** (zip).

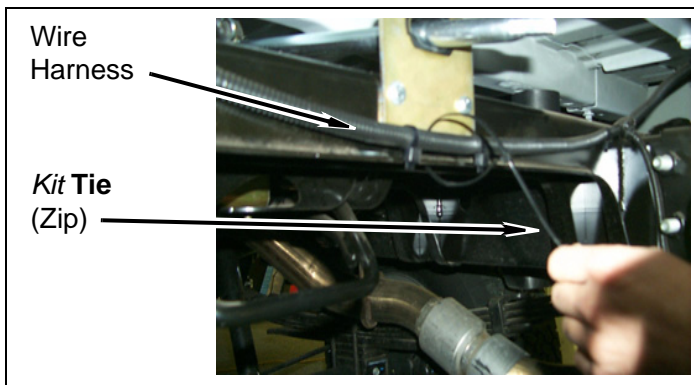

- k. Verify ratchet tube is visible through hole in bed and plastic ratchet tube guide. Adjust **kit bracket** (spare tire ratchet tube), if necessary.

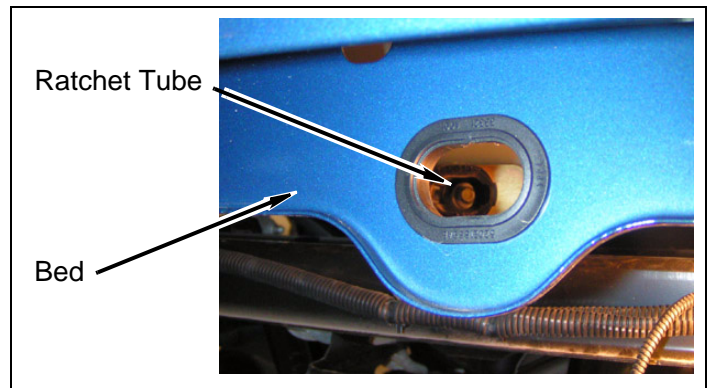

- l. Install spare tire on vehicle (see owner's manual).

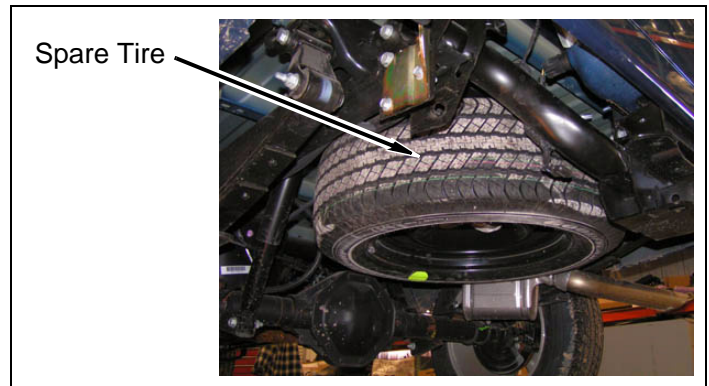

- m. Install ground strap to cab with bolt.

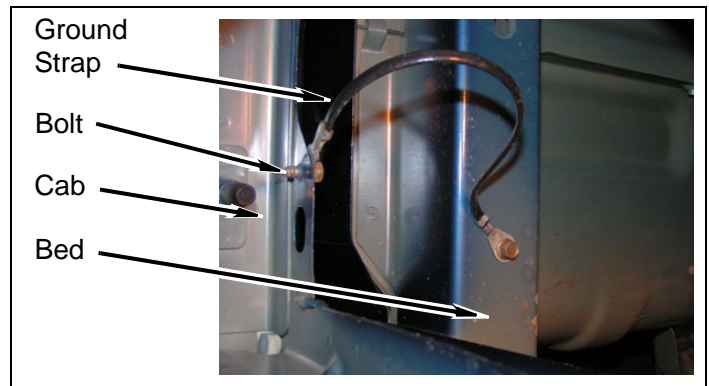

2. Rear bumper

⚠ WARNING

The following procedure is intended only to enhance the appearance of the vehicle. The rear bumper will no longer be rated for towing of any kind. Towing with the rear bumper after it has been lifted can result in death, serious personal injury, or damage to the vehicle. Towing after the bumper has been lifted should be accomplished using a rated Class III receiver type hitch.

- a. Apply a few drops of *kit Loctite*® to factory bolts. Install *kit bracket* (rear bumper, middle) on trailer hitch with two factory bolts. DO NOT TIGHTEN.

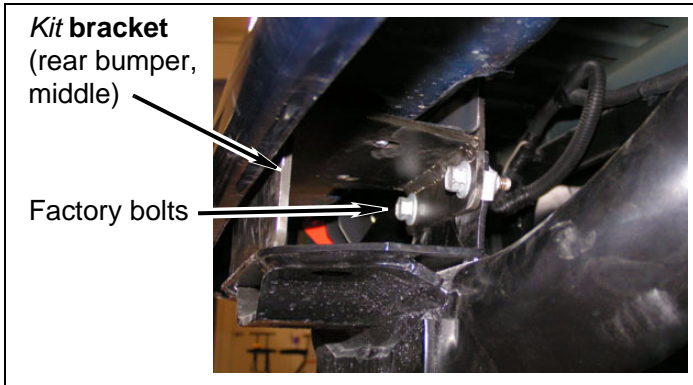

- b. Apply a few drops of *kit Loctite*® to factory bolts. Install *kit brackets* (rear bumper) to frame with factory hardware. DO NOT TIGHTEN.

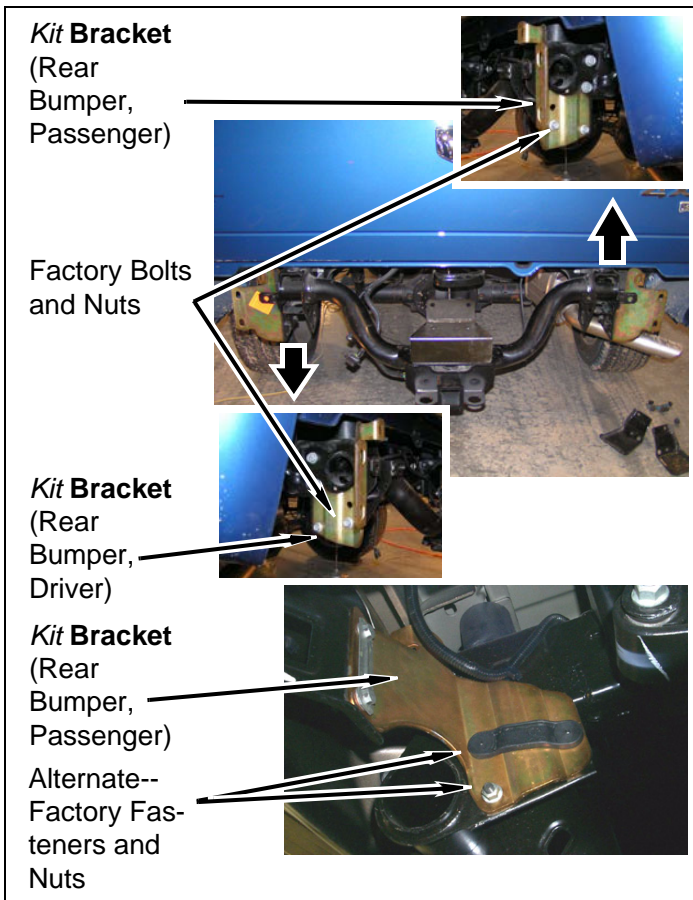

- c. Apply a few drops of *kit Loctite*® to factory bolts. Install rear bumper on *kit brackets* (rear bumper) with factory two double bolt fasteners and four nuts. DO NOT TIGHTEN.

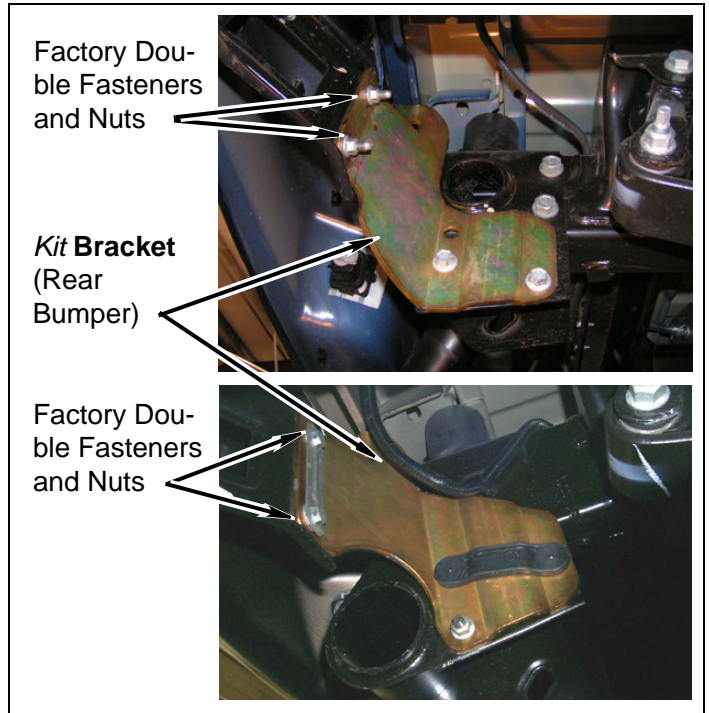

- d. Install rear bumper to *kit bracket* (rear bumper, middle) with two *kit bolts* (7/16" x 1-1/2"), four *kit washers* (7/16" USS) and two *kit nuts* (7/16" Nylock). DO NOT TIGHTEN.

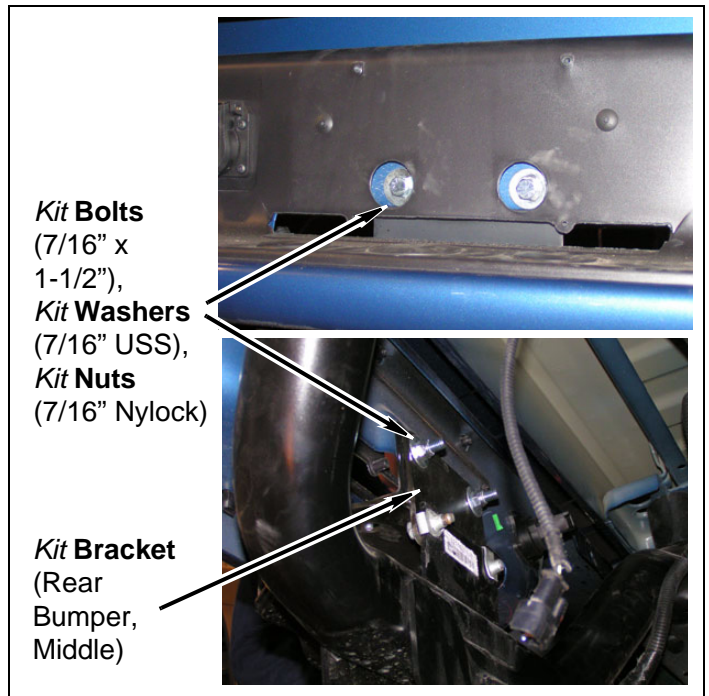

- e. Install **kit brackets** (rear bumper) to bumper with two factory bolts and nuts. **DO NOT TIGHTEN.**

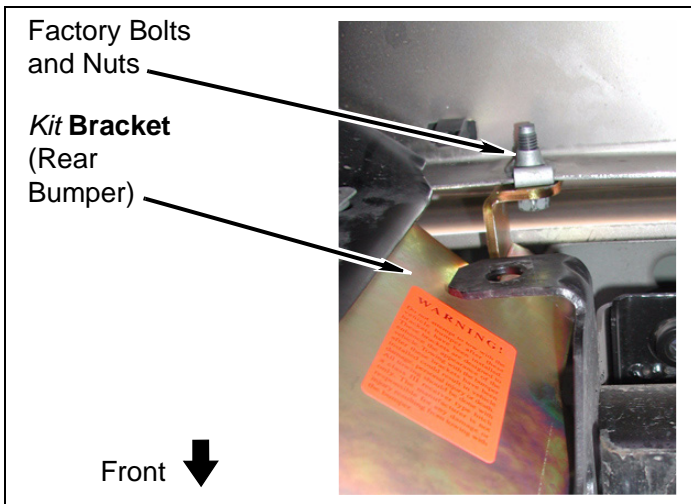

- f. Align rear bumper to previous bed-to-bumper measurements. Tighten all hardware.
- g. Connect wiring harnesses to bumper.

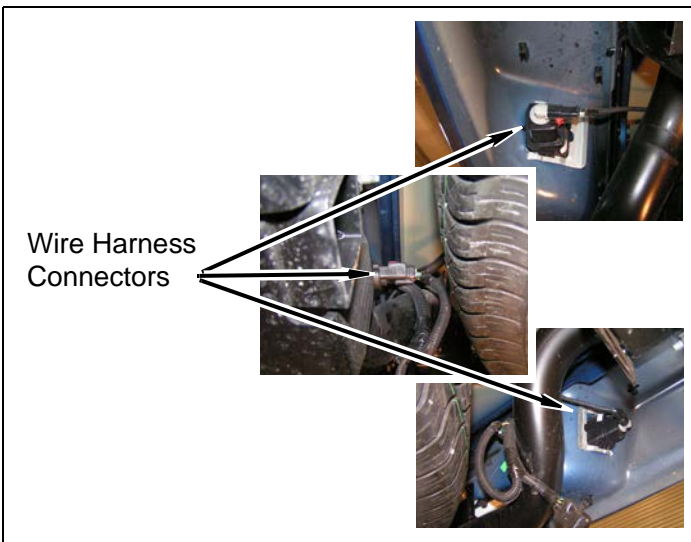

- h. Install license plate with two factory screws.

Underside of Vehicle

1. Crush blocks

⚠ WARNING

A certified welder should perform all welding.

- a. Weld two **kit blocks** (3" crush) onto passenger side frame, below bed, where shown.

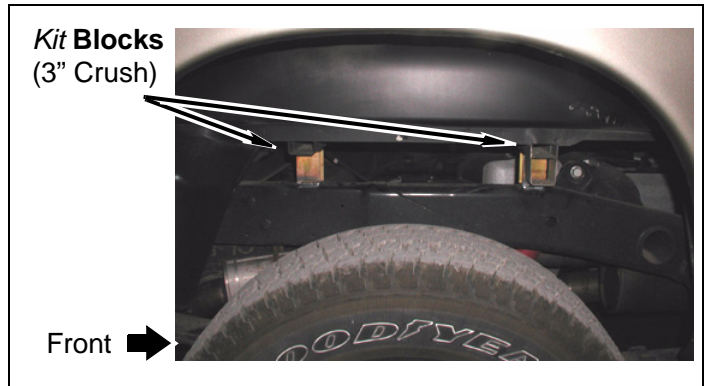

- b. Repeat above step for driver side.

⚠ WARNING

Use extreme caution when working near the fuel lines and the fuel tank. Clean up spilled fuel immediately. A spark could cause an explosion or fire resulting in serious personal injury and property damage.

2. **1500 Models:** Fuel filler

- a. Slide white retaining clip outward and remove vent hose from fuel filler assembly.

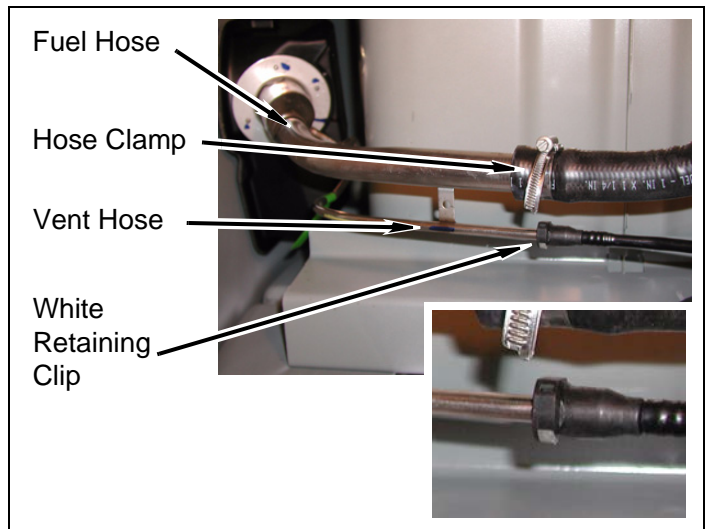

- b. Remove hose clamp and fuel hose, vent hose and fuel filler assembly from vehicle.

c. Carefully cut metal vent tube as shown.

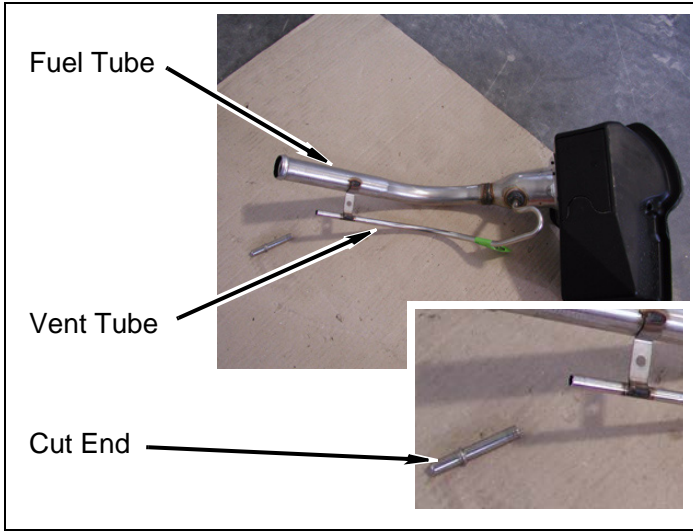

d. Install *kit extension* (vent, 1/4" x 3") between cut ends of metal vent tube with two *kit clamps* (#6 hose). DO NOT TIGHTEN.

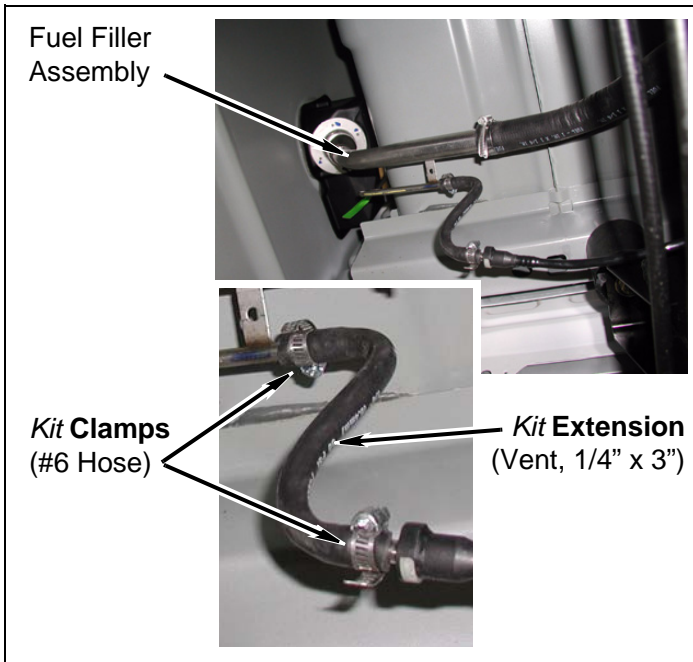

e. Install fuel filler assembly on fuel and vent hose. Push in white retaining clip to secure vent hose.

f. Install fuel filler assembly on bed with three bolts. Install fuel cap.

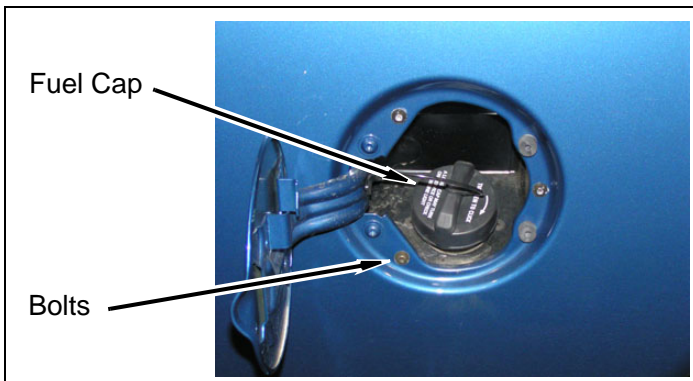

g. Adjust fuel filler hoses as necessary. Tighten all hose clamps.

3. 2500 Models: Fuel filler

a. Remove two hose clamps and fuel filler assembly from fuel tank.

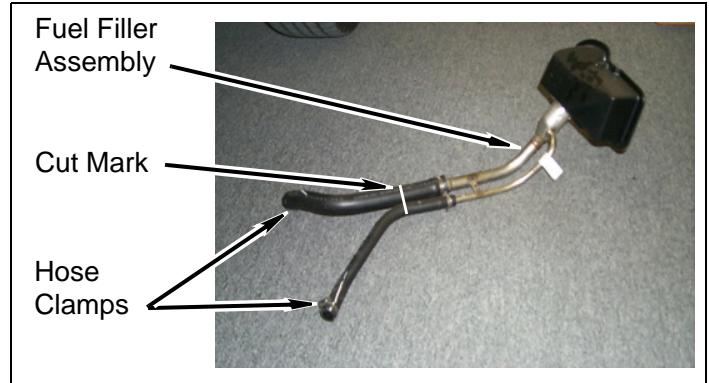

b. Carefully cut vent and fuel hose 2" from end of metal tubes.

c. Install *kit extension* (fuel filler, metal) between cut ends of fuel hose with two *kit clamps* (#28 hose). DO NOT TIGHTEN.

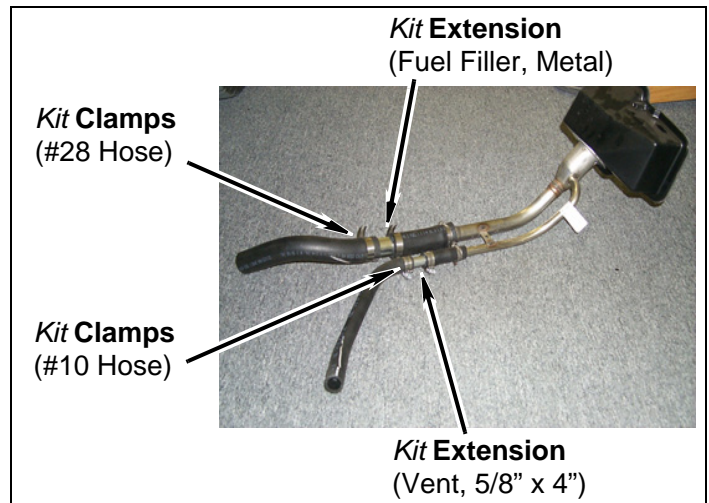

d. Install *kit extension* (vent, 5/8" x 4") between cut ends of vent hose with two *kit clamps* (#10 hose). DO NOT TIGHTEN.

e. Install fuel filler assembly on fuel tank with two hose clamps.

- f. Install fuel filler assembly to bed with three factory bolts. Install fuel cap. Tighten all hose clamps.

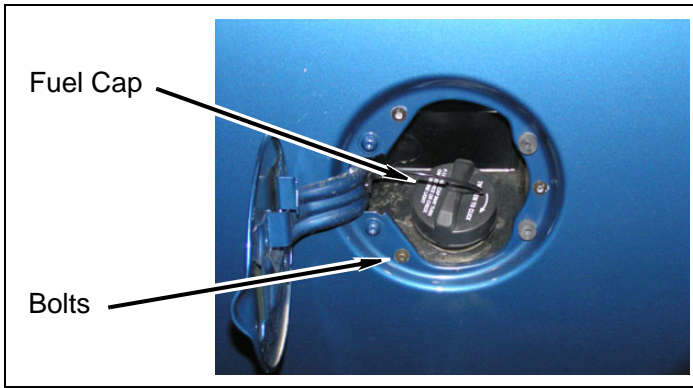

4. Transfer case shift linkage

- a. Install shift rod in transfer case input lever.
- b. Install trunnion in 4WD shift lever.

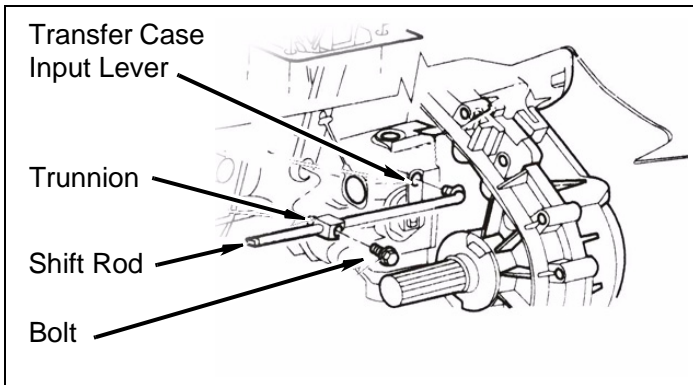

- c. Verify the 4WD shift lever operation. Ensure there is complete engagement in all ranges. It may be necessary to adjust the position of the trunnion on the shift rod to obtain proper engagement in all ranges.

5. Parking brake cable

- a. Using *kit bracket* (parking brake) as a template, drill a 5/16" hole in bottom of factory parking brake mount on driver side frame rail.

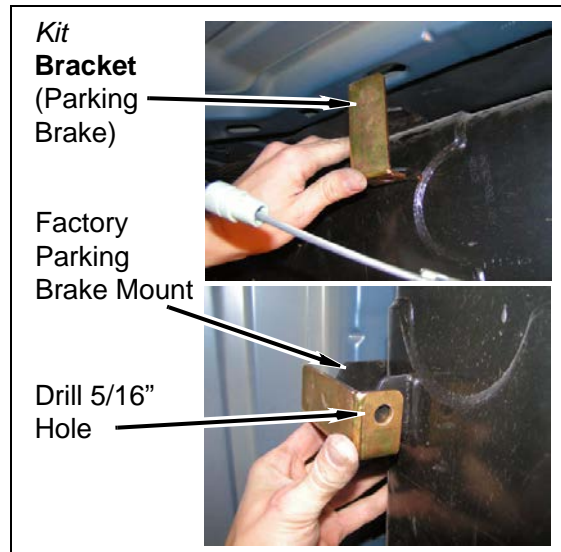

- b. Install *kit bracket* (parking brake) on factory parking brake mount with one *kit bolt* (5/16" x 1"), two *kit washers* (5/16" USS) and one *kit nut* (5/16" Nylock). DO NOT TIGHTEN.

- c. Install *kit bracket* (parking brake) on factory parking brake mount with one *kit bolt* (7/16" x 1"), two *kit washers* (7/16" SAE) and *kit nut* (7/16" Nylock). Tighten all hardware.

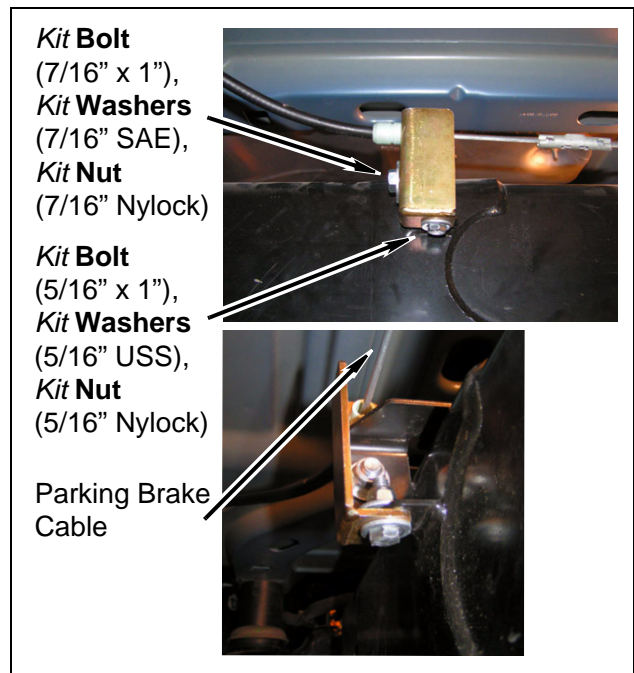

- d. Route front parking brake cable through largest hole in *kit bracket* (parking brake) and connect parking brake cable.

6. Ground strap

- a. Install **kit bracket** (3" ground, big hole) to frame on driver side with factory bolt.
- b. Install ground strap to **kit bracket** (3" ground, big hole) with **kit bolt** (1/4"-20 x 1"), two **kit washers** (1/4" SAE), **kit nut** (1/4"-20 Ny-lock) and **kit nut** (1/4"-20 Ny-lock).

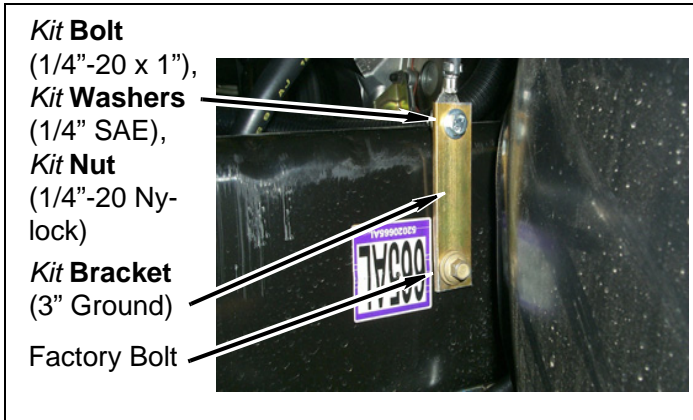

7. Wire harnesses and brake lines

- a. Install wire harness to body mount bracket on driver side with clip.

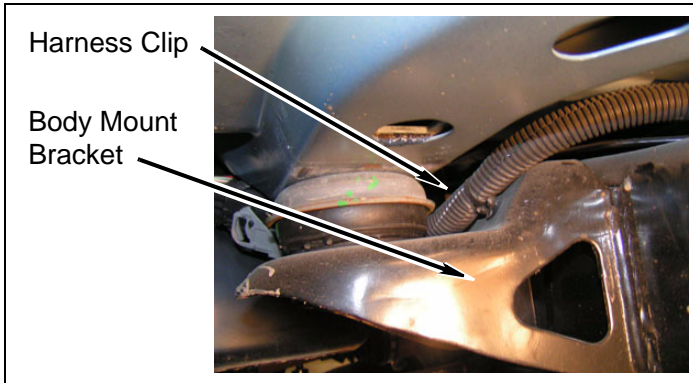

- b. If possible, install clip, two harnesses, hose and three hard lines on driver side of frame rail.

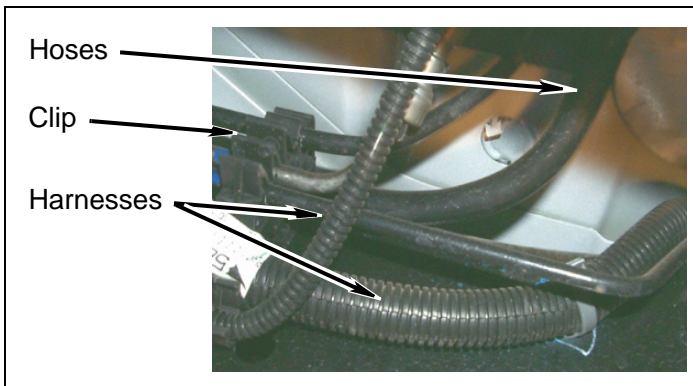

- c. Install clip on driver side frame, if possible.

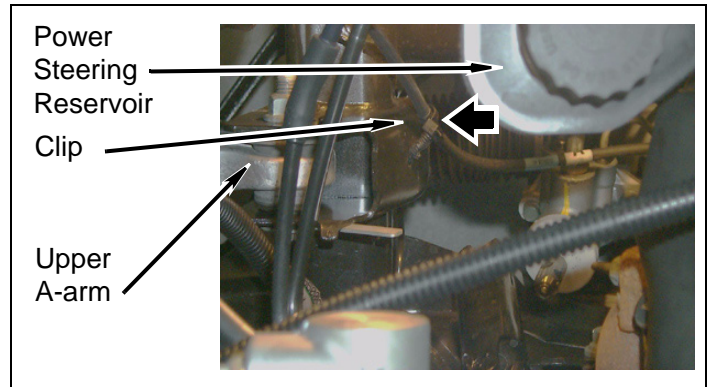

- d. **2003-2004 Models:** If possible, install brake lines on retaining clip on driver and passenger front inner fender wheel well.

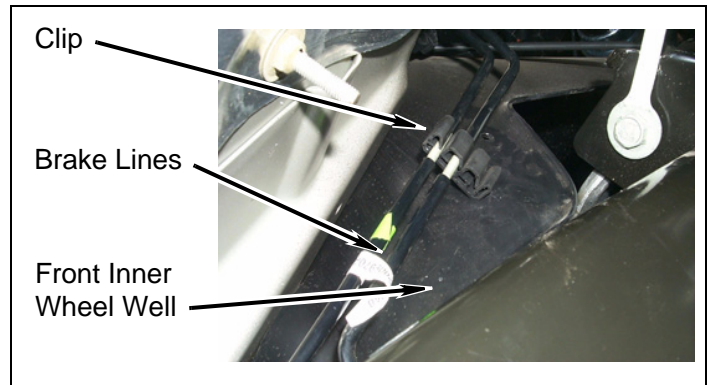

CAUTION
Some slight bending of the brake lines is required to align brackets with holes in frame rail. Use caution when bending brake line.

- e. Carefully bend brake lines and install bolts securing brake line brackets on driver side.

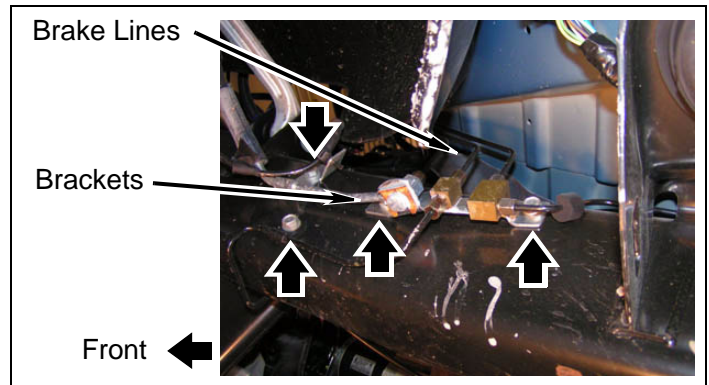

- f. Install transmission wire harness on frame mount clip.

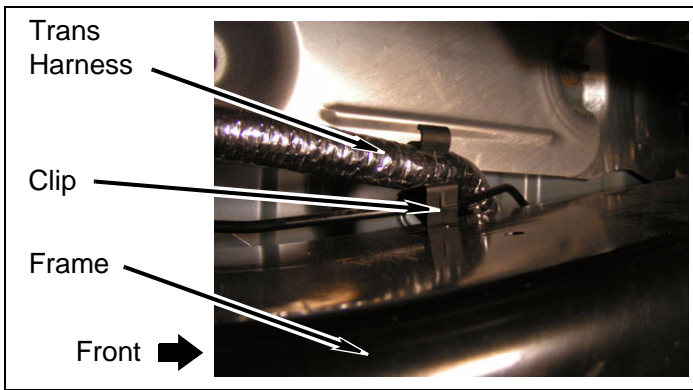

- b. Scribe a line along side of *kit extension* (manual transmission shift lever). Position *kit extension* between two pieces of transmission shift lever. Ensure scribed lines on *kit extension* and transmission shift lever align. Weld *kit extension* in place.

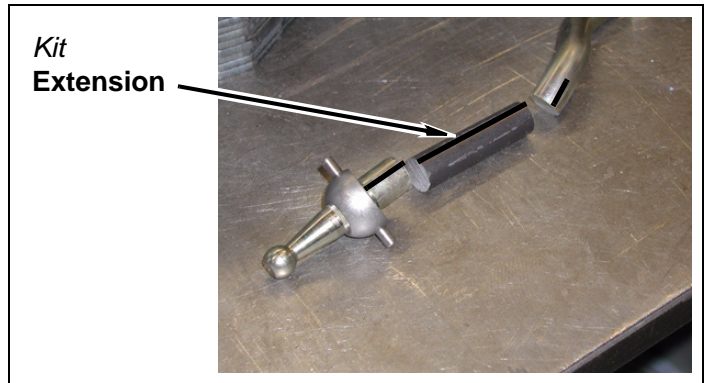

Inside of Vehicle

⚠ WARNING
DO NOT DAMAGE any of the parts attached to the shift levers during cutting and/or welding. Damage to the shift lever equipment could result in serious injury or property damage.

⚠ WARNING
A certified welder should perform all welding.

- c. Grind welded surfaces smooth in order to install mounting plate and shim to shift lever.

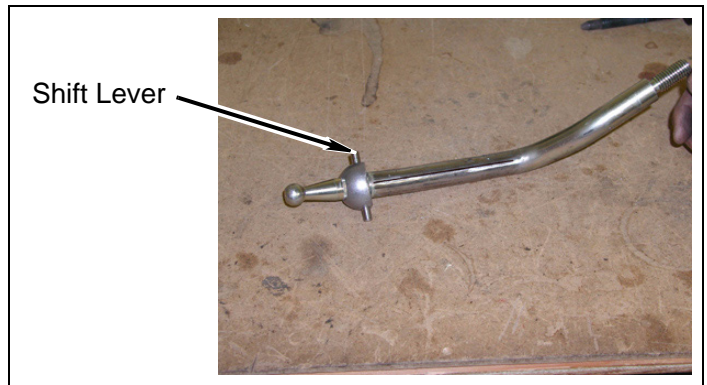

1. Manual transmission shift lever

- a. Scribe a line along side of transmission shift lever (below lowest bend). Cut lever into two pieces and deburr as necessary.

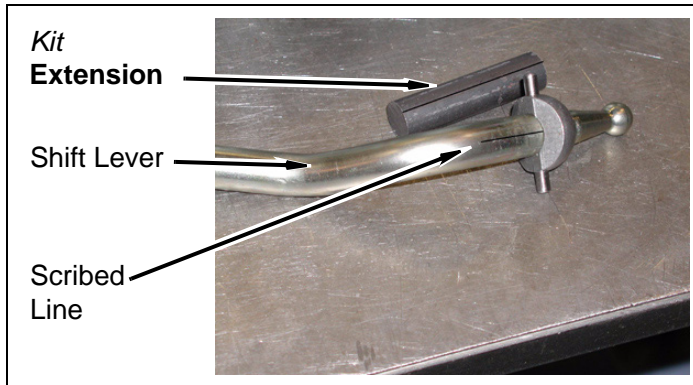

- d. Install two plastic shift tabs, plastic ball, shim and mounting plate on shift lever.

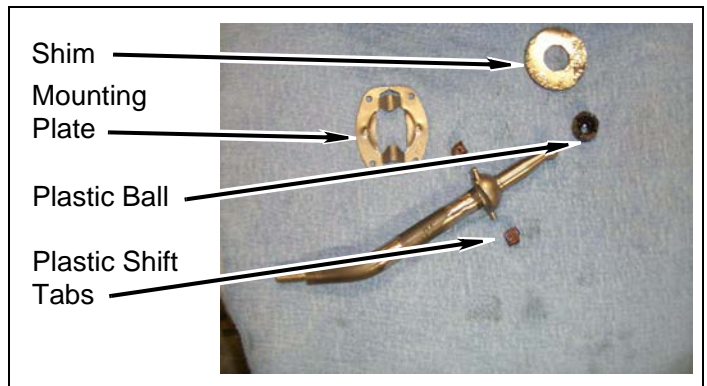

- e. Install shift lever to shift tower with four Torx bolts.

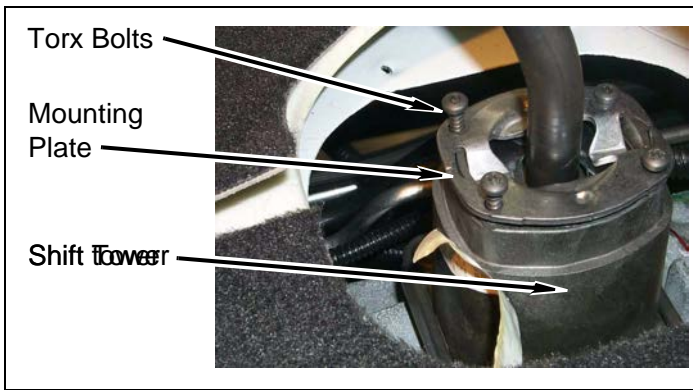

- f. Install rubber cover on shift tower.

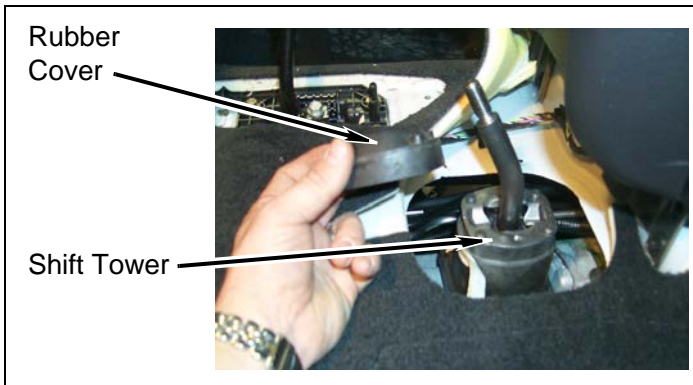

- g. Install shift lever boot seal to floor with six bolts.

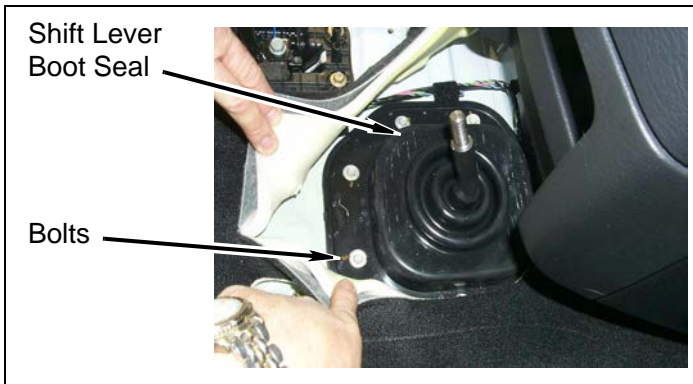

- h. Install center console to floor by feeding transfer case shift boot through opening in center console.

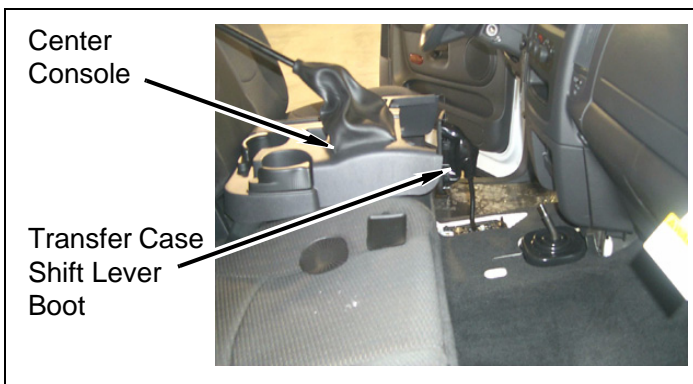

- i. Screw transmission shift lever onto shift tower lever.

- j. Install bolts securing center console to floor.

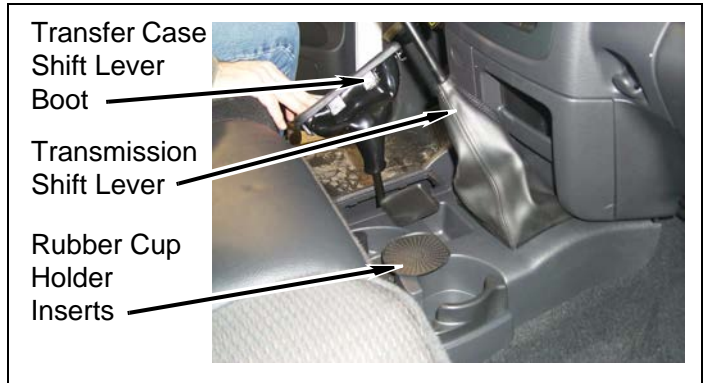

- k. Install transfer case shift lever boot to center console by depressing clips.

- l. Replace rubber cup holder inserts into center console.

- m. Check transmission shift lever operation. Ensure there is complete engagement in all gears.

Engine Compartment

1. Steering shaft



⚠ WARNING

Verify the steering extension is securely installed as specified in the instructions. Failure to do so may cause steering malfunction, resulting in property damage or serious personal injury.

- a. Set **kit extension** (steering) in position on rack and pinion. Ensure marks on rack and pinion and intermediate shaft are aligned.

- b. Install ground strap to **kit bracket** (3" ground) with **kit bolt** (1/4"-20 x 1"), two **kit washers** (1/4" SAE) and **kit nut** (1/4"-20 Nylock).

- 3. Install two heater hoses into clip on passenger side of firewall.

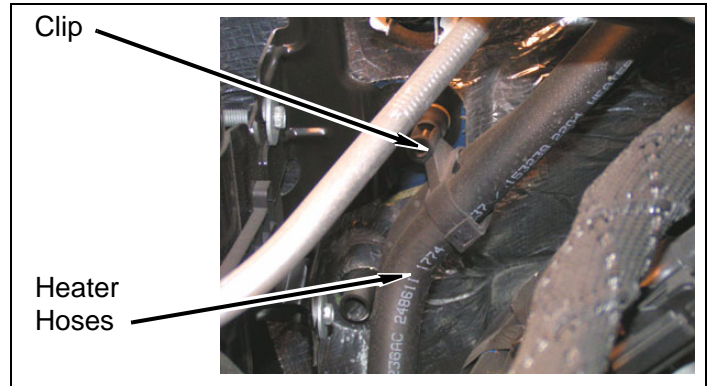

- 4. If possible, install brake sensor harness on passenger and driver fender wells.

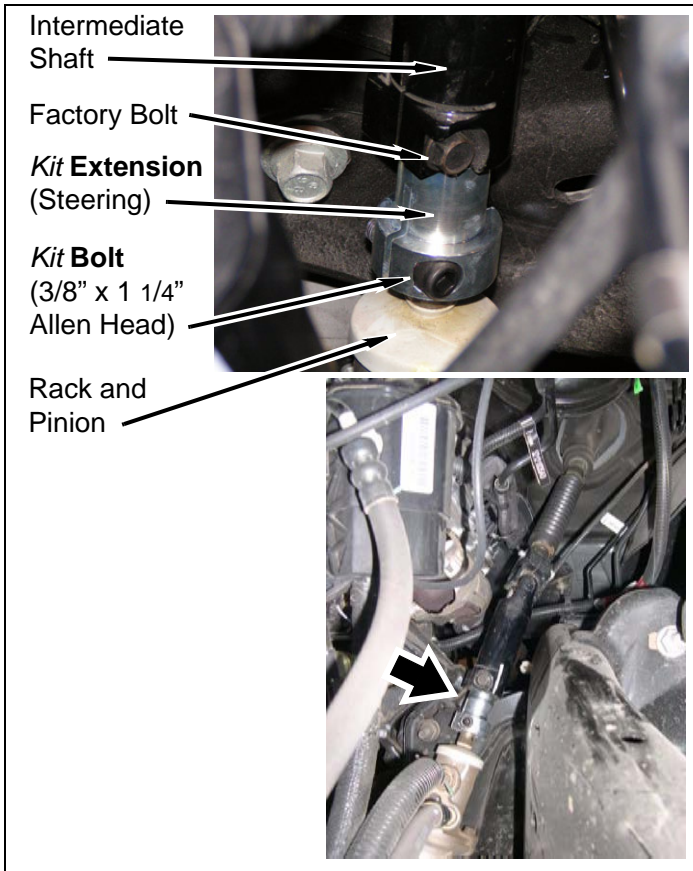
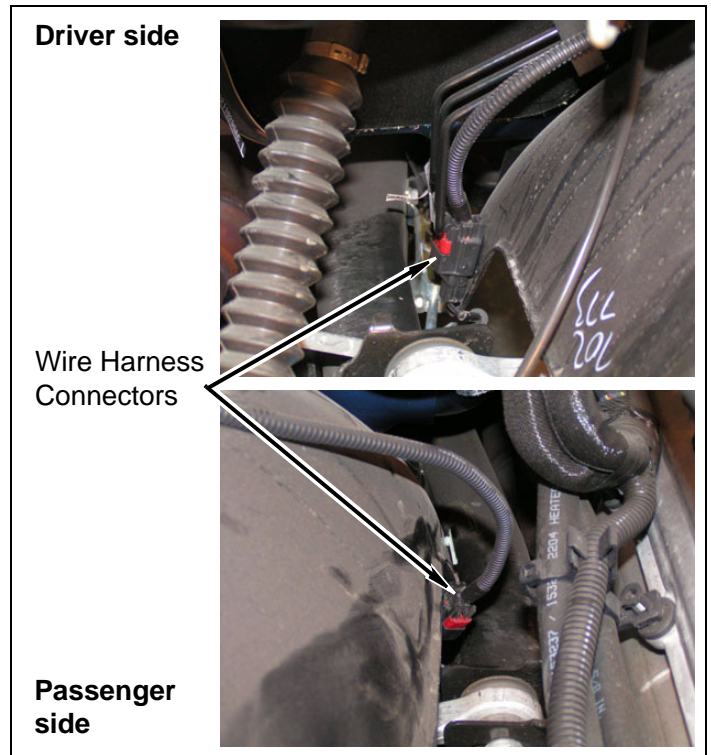

- b. Install intermediate shaft on **kit extension** (steering), ensuring marks on intermediate shaft and rack and pinion are aligned.
- c. Apply a few drops of **kit Loctite®** to factory bolt and **kit bolt** (3/8" x 1 1/4" Allen head).
- d. Install and tighten bolts to 33 lb.-ft.

2. 2003 Models: Ground strap

- a. Install **kit bracket** (3" ground) on firewall stud with factory nut.

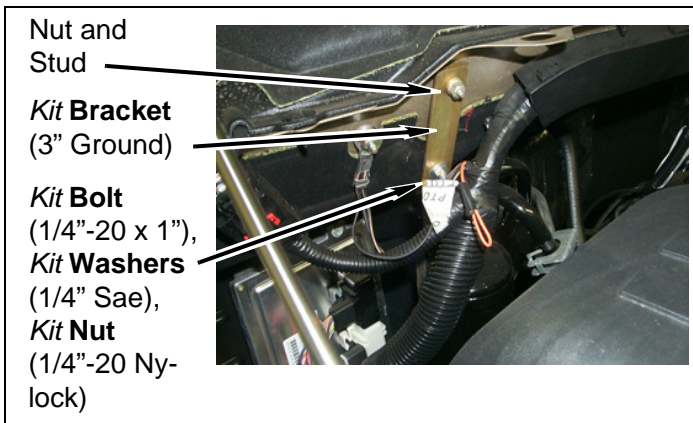

5. Fan shroud

- a. Mark a line on fan shroud as shown. Ensure line is exactly as appears below.

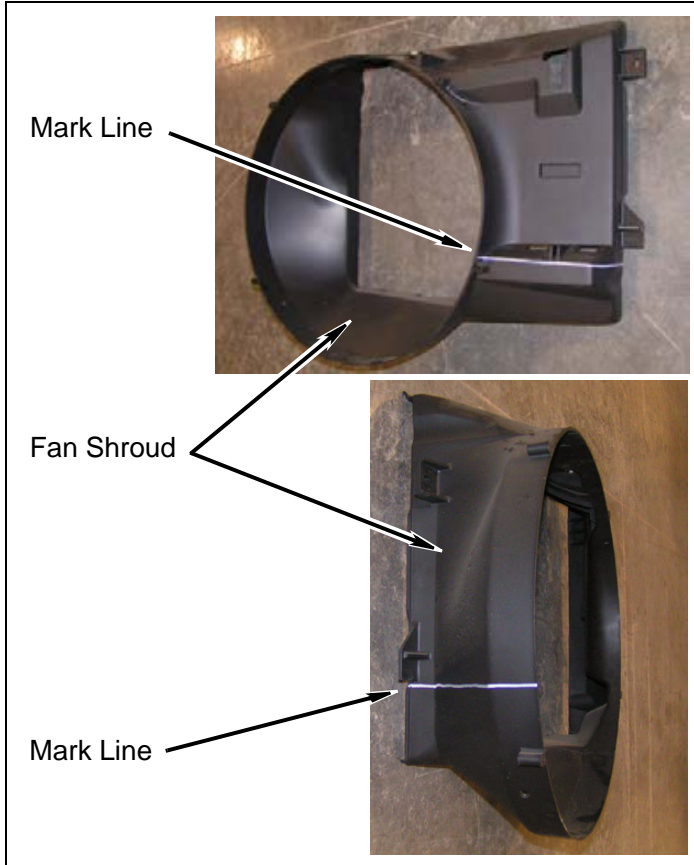

- b. Cut fan shroud along marked lines in two halves.

- c. Remove mounting tab from lower half of fan shroud as shown.

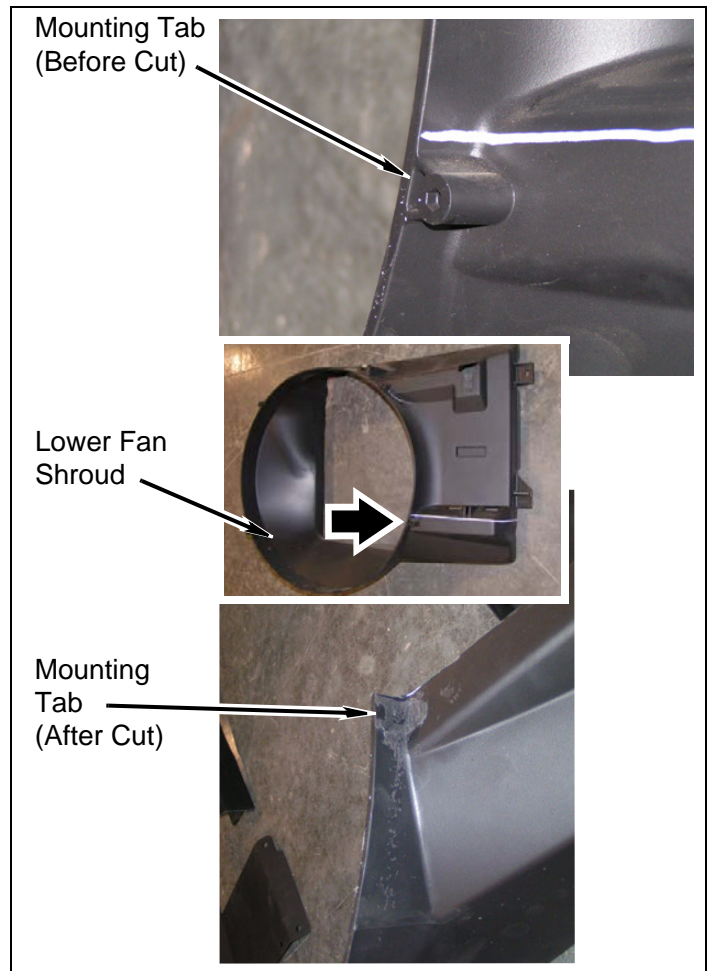

- d. Position *kit bracket* (fan shroud, passenger) on outside upper fan shroud. Using *kit bracket* (fan shroud, passenger) as a template, mark and drill a 1/4" hole corresponding to each hole on *kit bracket* (fan shroud, passenger). DO NOT DRILL lower portion of fan shroud at this time.

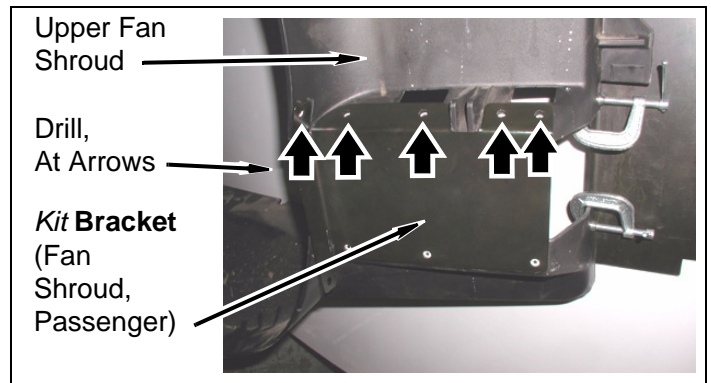

- e. Position **kit bracket** (fan shroud, driver) on outside upper fan shroud. Using **kit bracket** (fan shroud, driver) as a template, mark and drill a 1/4" hole corresponding to each hole on **kit bracket** (fan shroud, driver). **DO NOT DRILL** lower portion of fan shroud at this time.

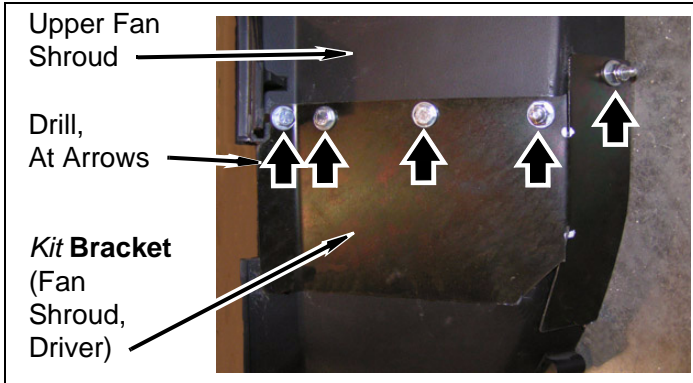

CAUTION
 Insert **kit bolts** into fan shroud so threads are away from fan, if possible, to avoid contact between fan and **kit bolts**.

- f. Attach **kit brackets** (fan shroud) to upper portion of fan shroud with **kit bolt** (1/4"-20 x 1"), two **kit washers** (1/4" SAE) and **kit nut** (1/4"-20 Nylock) at each drilled hole location. Snug, but **DO NOT TIGHTEN**.

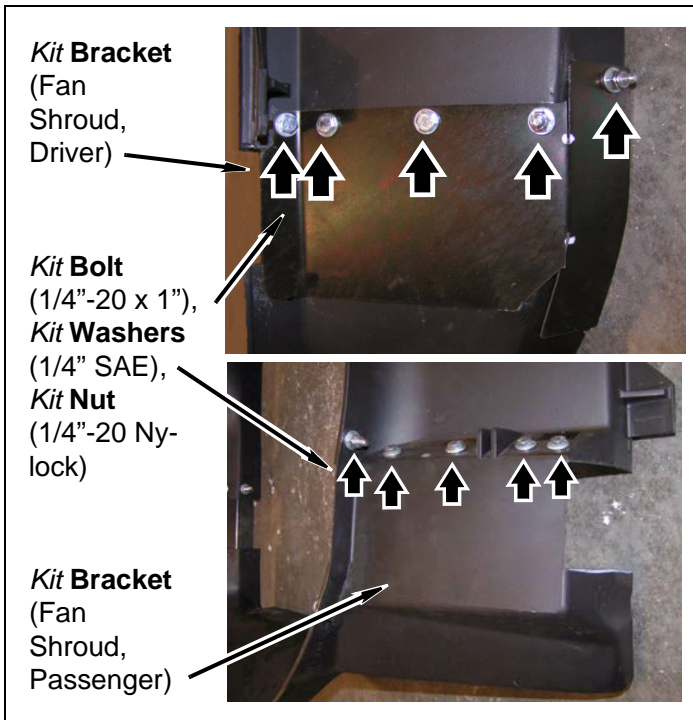

- g. Position lower portion of fan shroud with **kit brackets** (fan shroud) 3" from upper portion of fan shroud as shown.

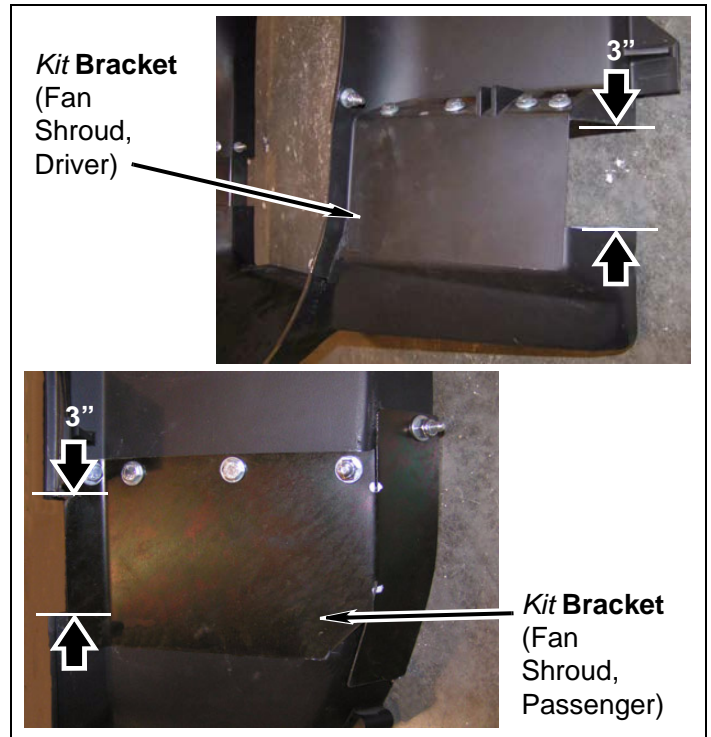

- h. Using **kit brackets** (fan shroud) as templates, mark and drill a 1/4" hole corresponding to each hole on **kit brackets** (fan shroud).

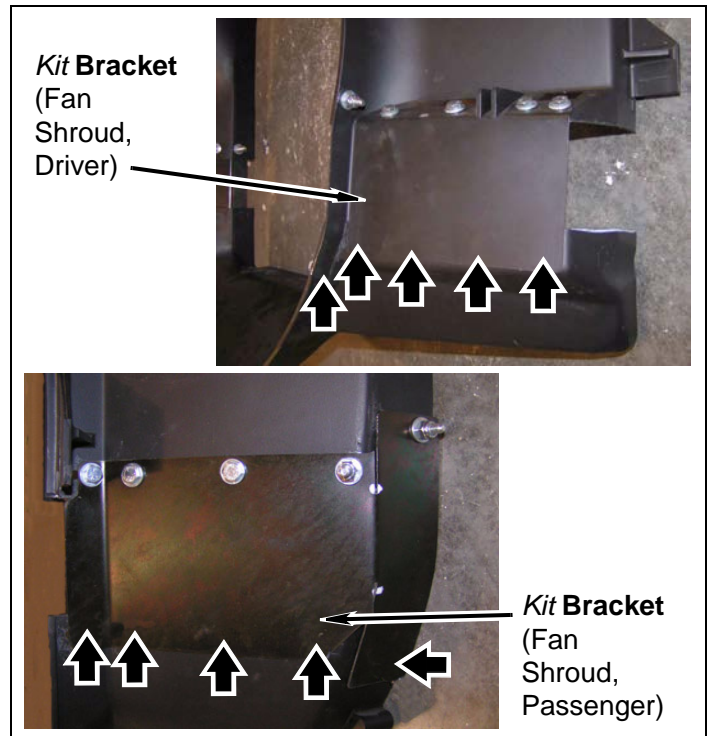

- i. Attach **kit brackets** (fan shroud) to lower portion of fan shroud with **kit bolt** (1/4"-20 x 1"), two **kit washers** (1/4" SAE) and **kit nut** (1/4"-20 Nylock) at each drilled hole location. Snug, but DO NOT TIGHTEN.

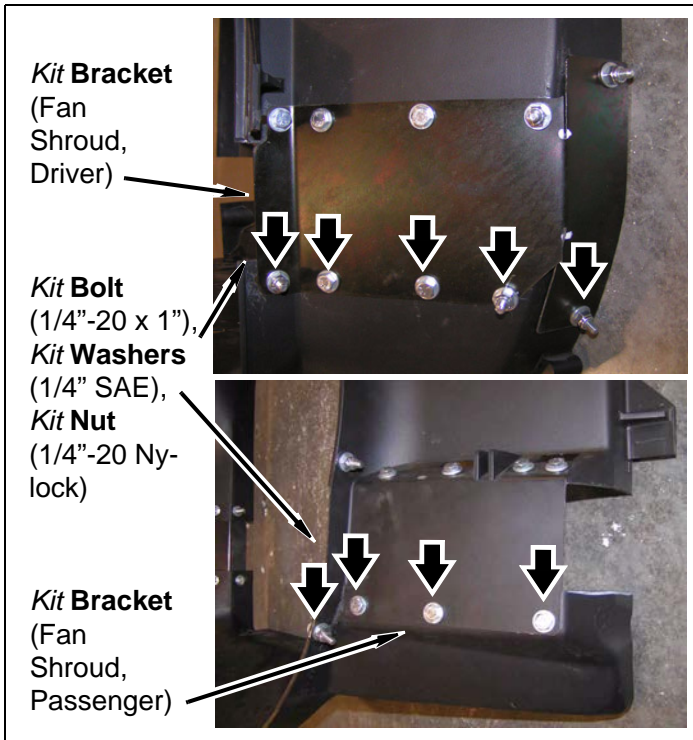

- j. Position **kit gap guard** (fan shroud) inside upper and lower portions of fan shroud. Using **kit gap guard** (fan shroud) as a template, mark and drill a 1/4" hole corresponding to each hole on **kit gap guard** (fan shroud).

NOTE
It may be possible to use some of the existing holes drilled in the previous step to attach **kit gap guard** (fan shroud) to upper and lower portions of the fan shroud.

- k. Attach **kit gap guard** (fan shroud) to upper and lower portions of fan shroud with **kit bolt** (1/4"-20 x 1"), two **kit washers** (1/4" SAE) and **kit nut** (1/4"-20 Nylock) at each drilled hole location. Snug, but DO NOT TIGHTEN.

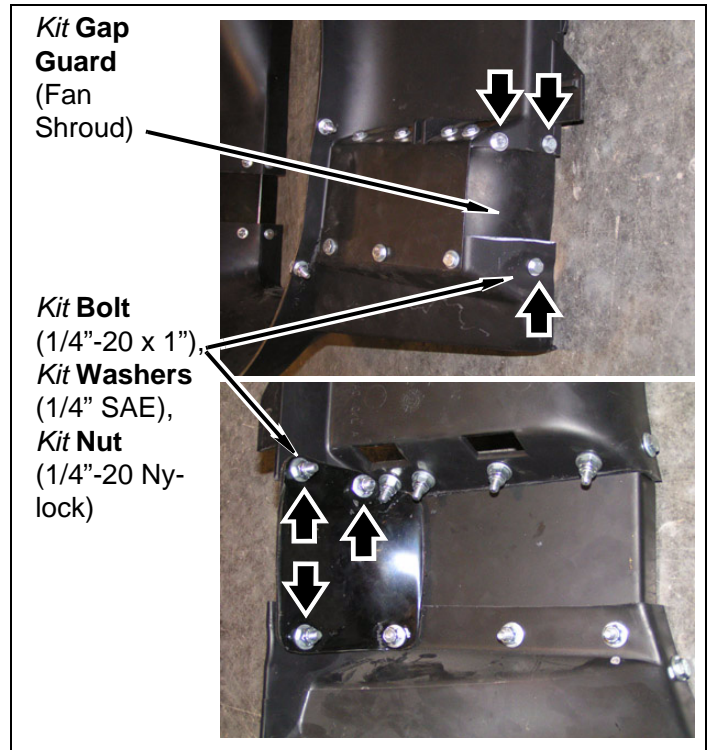

- l. Ensure a 3" spacing between upper and lower portions of fan shroud. Tighten all hardware.

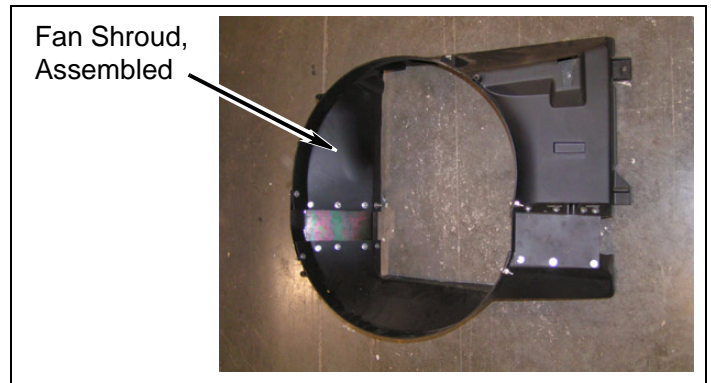

m. Remove two bolts securing power steering cooler to bottom of radiator. Allow power steering cooler to hang under radiator. DO NOT DISCONNECT power steering cooler lines.

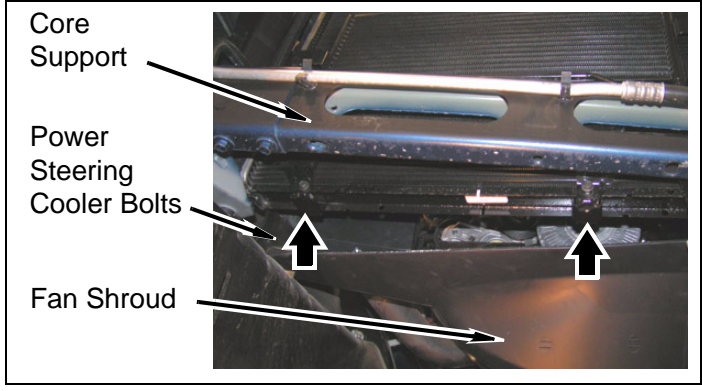

n. Position fan shroud onto radiator. Ensure fan shroud tabs are seated completely in radiator slots. Install fan shroud to radiator with two factory bolts.

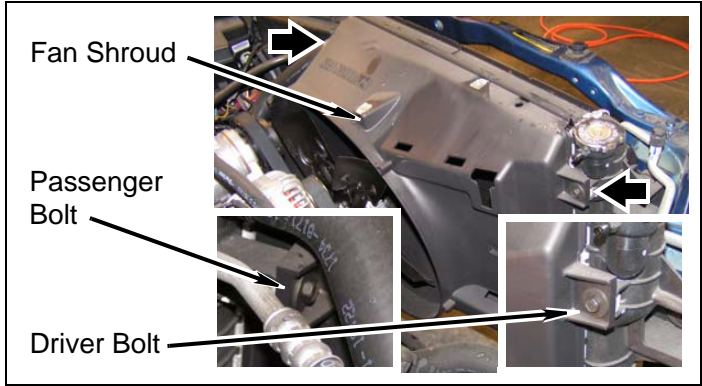

o. Pull fan towards radiator off fan clutch shaft. Install bolts securing fan to fan clutch.

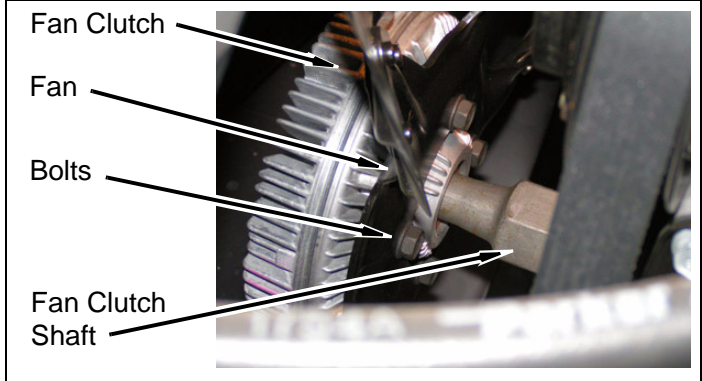

p. Install two automatic transmission cooler lines on engine block with clip.

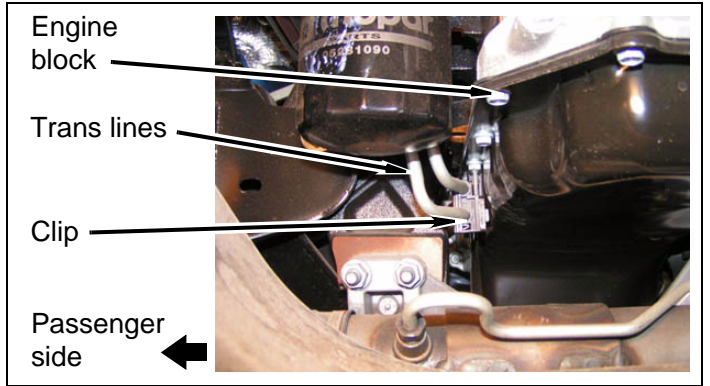

6. Power steering cooler

- a. Position two **kit spacers** (1-1/2" cooler) in bottom of radiator.
- b. Install two **kit brackets** (2" S-shaped) on bottom of radiator, through **kit spacers** (1-1/2" cooler), with two factory bolts. DO NOT INSTALL factory nuts on factory bolts at this time.

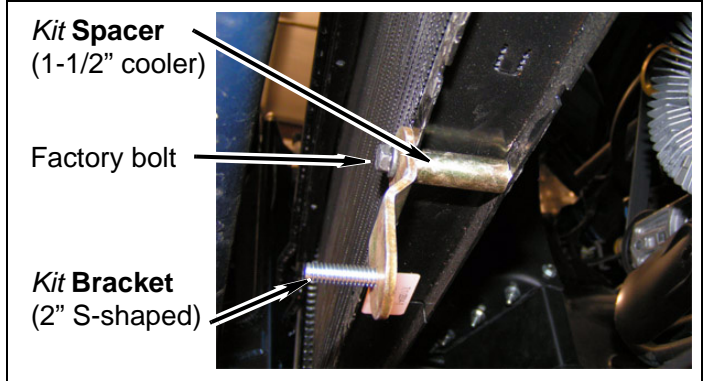

c. Install power steering cooler on two **kit brackets** (2" S-shaped) with two **kit washers** (1/4" SAE) and two **kit nuts** (1/4"-20 Nylock). DO NOT TIGHTEN.

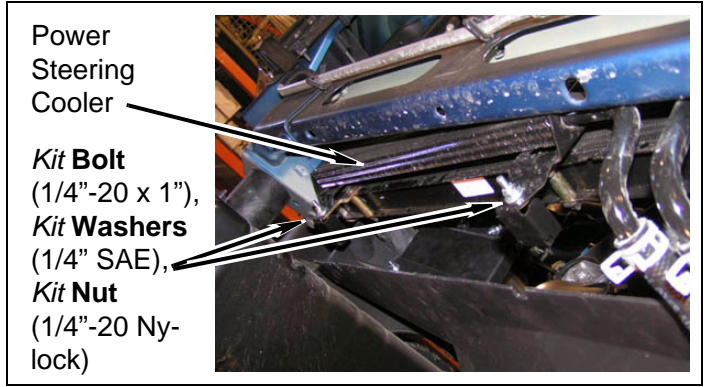

7. Lower fan shroud block off plate

- a. Install **kit plate** (fan shroud, driver) and **kit plate** (fan shroud, passenger) at middle with two **kit bolts** (1/4"-20 x 1"), four **kit washers** (1/4" SAE) and two **kit nuts** (1/4"-20 Nylock). DO NOT TIGHTEN.

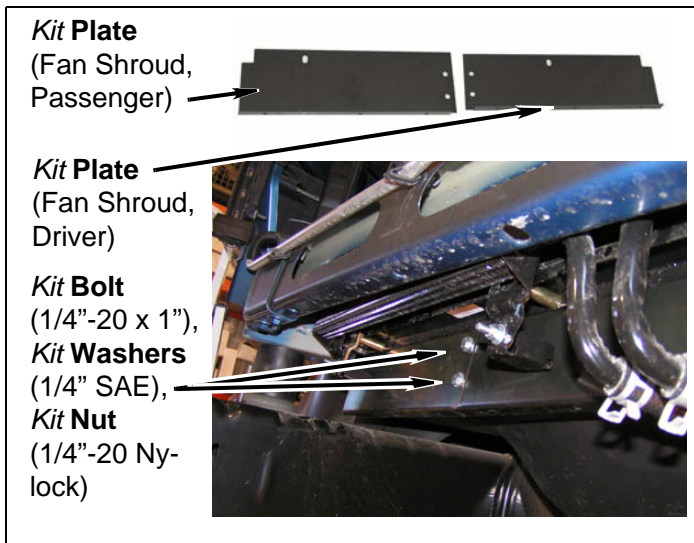

- b. Install **kit plates** (fan shroud) to rear of radiator and front of lower fan shroud as shown. Power steering cooler bolts from previous step will align with holes in top of **kit plates** (fan shroud). Install **kit plates** with factory power steering cooler bolts and nuts. DO NOT TIGHTEN.
- c. Using **kit plates** (fan shroud) as a template, drill five 15/64" holes in lower fan shroud edge.
- d. Install **kit plates** (fan shroud) to fan shroud with five **kit clips** (push).

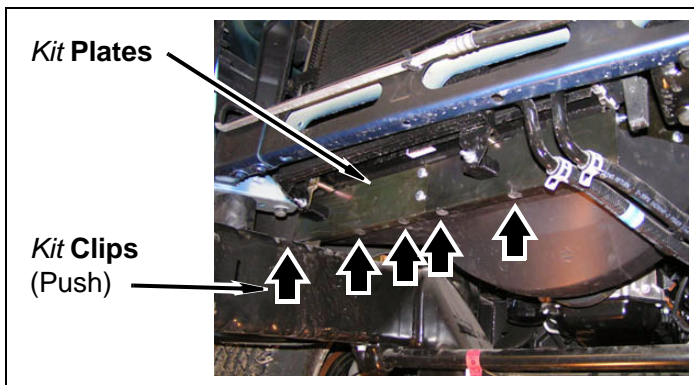

- e. Tighten two **kit bolts** (1/4"-20 x 1") attaching **kit plate** (fan shroud, driver) to **kit plate** (fan shroud, passenger).
- f. Tighten factory bolts and nuts attaching power steering cooler and **kit plates** (fan shroud) to radiator.

8. 2003 Models: Radiator overflow and window washer reservoirs

- a. Place window washer reservoir on fan shroud.
- b. Install two electrical connectors on window washer reservoir.

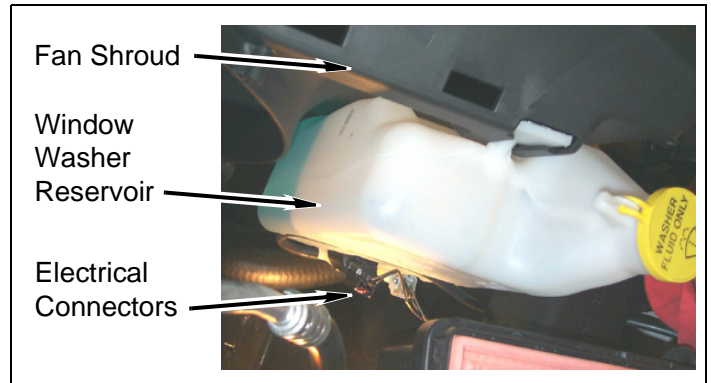

- c. Place radiator overflow reservoir on vehicle.
- d. Install bolts securing radiator overflow reservoir to fan shroud.

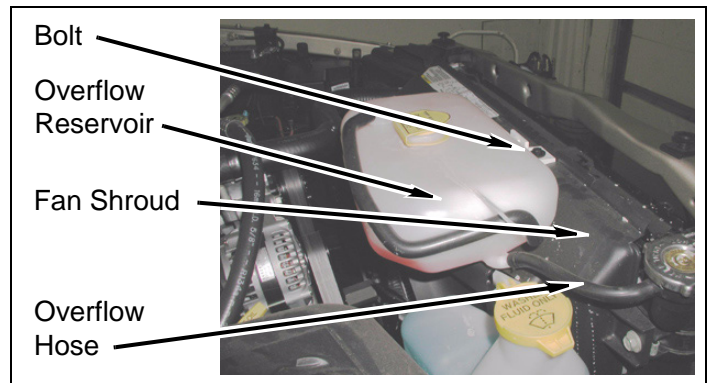

- e. Connect overflow hoses.

9. 2004-2005 Models: Radiator overflow and window washer reservoirs

- a. Place radiator overflow and window washer reservoirs on fan shroud.
- b. Install two electrical connectors on reservoirs.

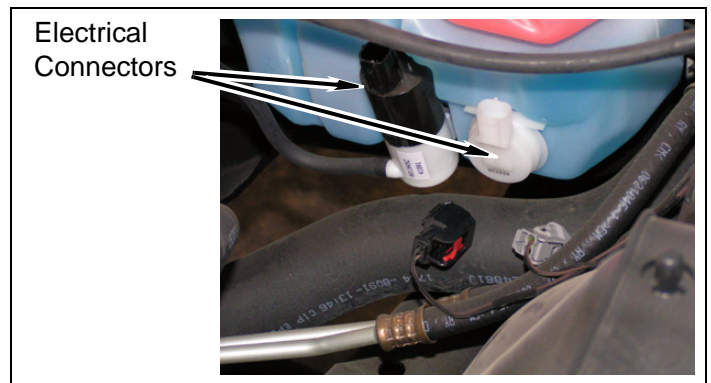

- c. Install bolts securing radiator overflow and window washer reservoirs to fan shroud.

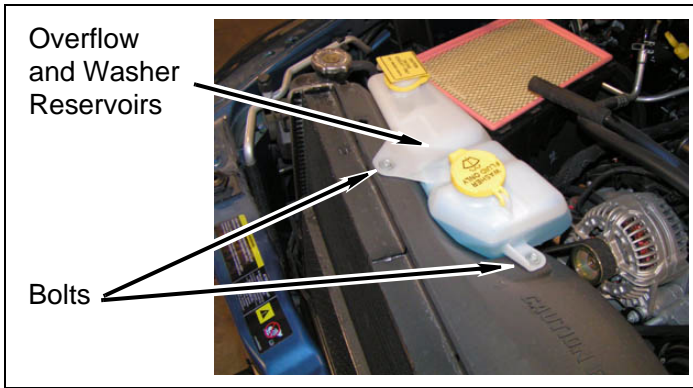

- d. Connect overflow and washer hoses.

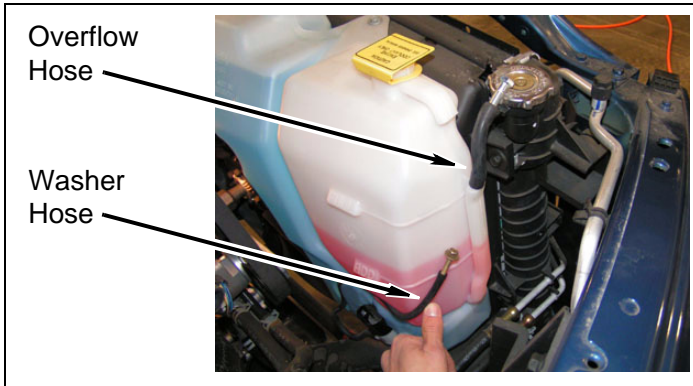

10. 2003 Models: Airbox

- a. Place airbox cover and hose on vehicle.
- b. Close four clips securing airbox cover and tighten airbox hose clamp at throttle body.

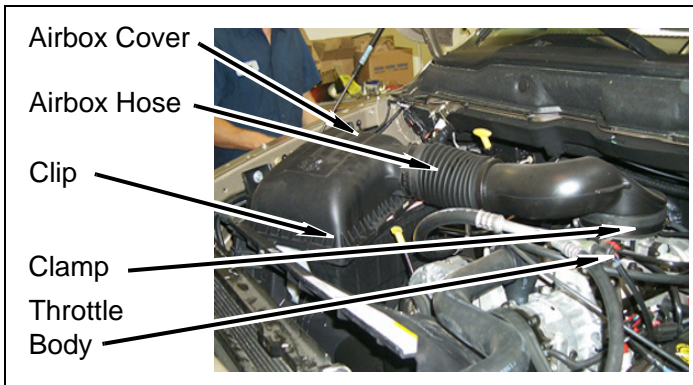

11. 2004-2005 Models: Airbox

- a. Place airbox cover, base and filter on vehicle.
- b. Close four clips securing airbox cover. Install breather hose on airbox cover. Tighten airbox hose clamp at intake housing.

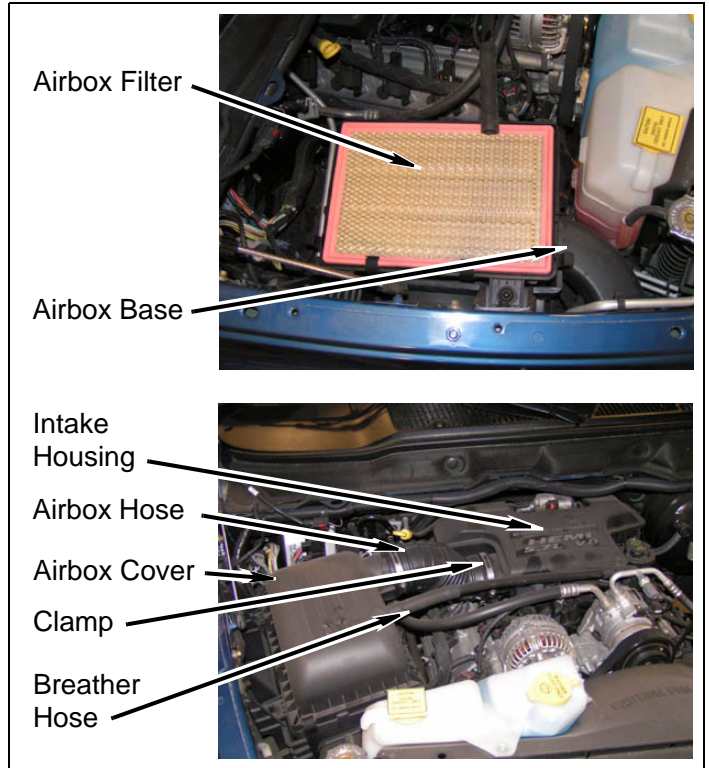

Front of Vehicle

- 1. Front bumper

- a. **1500 Models:** Trim lower edge of two front frame rails.

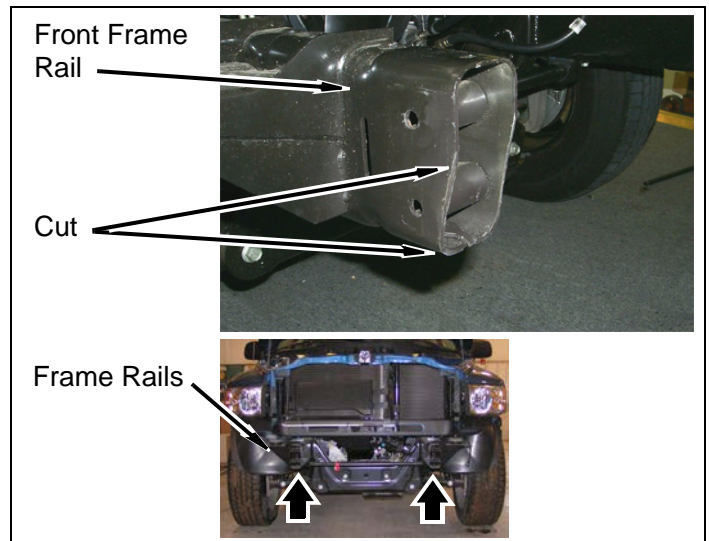

b. 1500 Models: Trim lower edges of driver and passenger front bumper brackets.

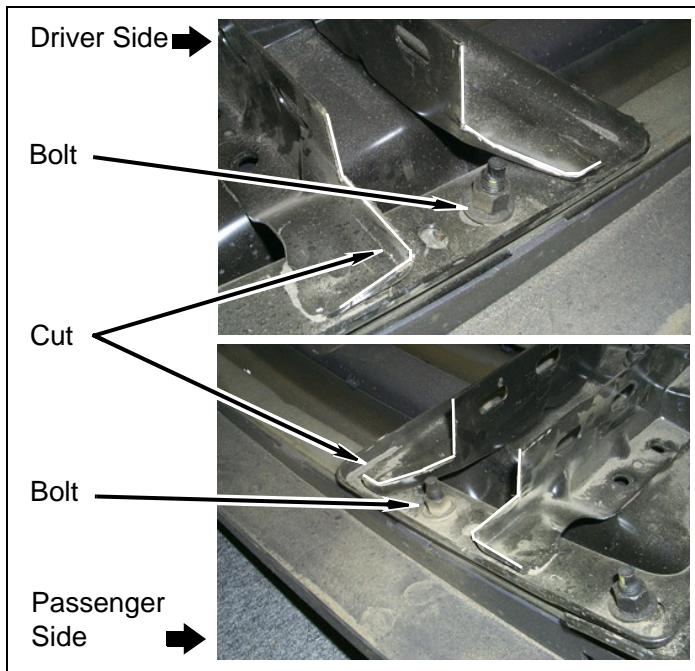

d. 2500 Models: Trim upper outside driver and passenger front bumper brackets.

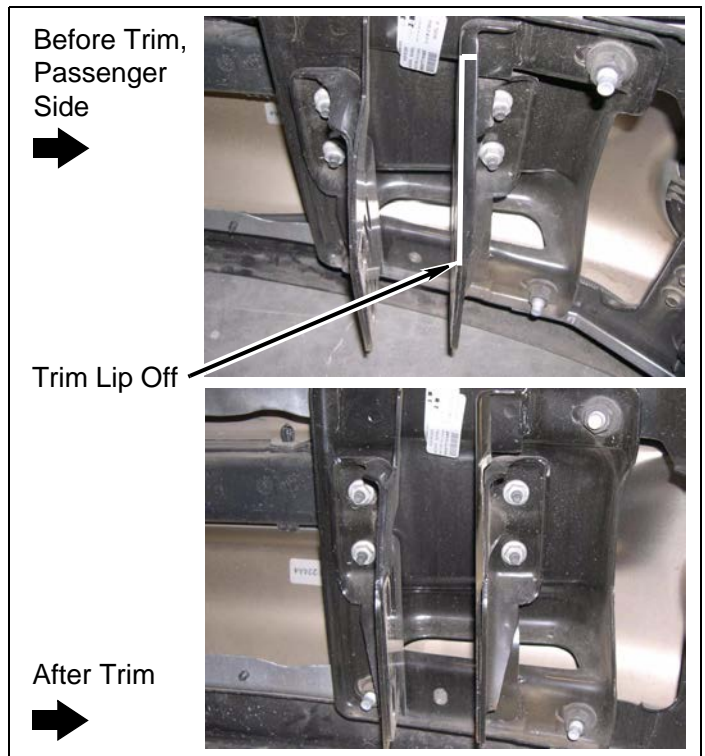

NOTE
It may not be necessary to perform the following procedure if tow hooks are not installed on the front bumper.

c. 2500 Models: Trim lower edges of driver and passenger front bumper brackets.

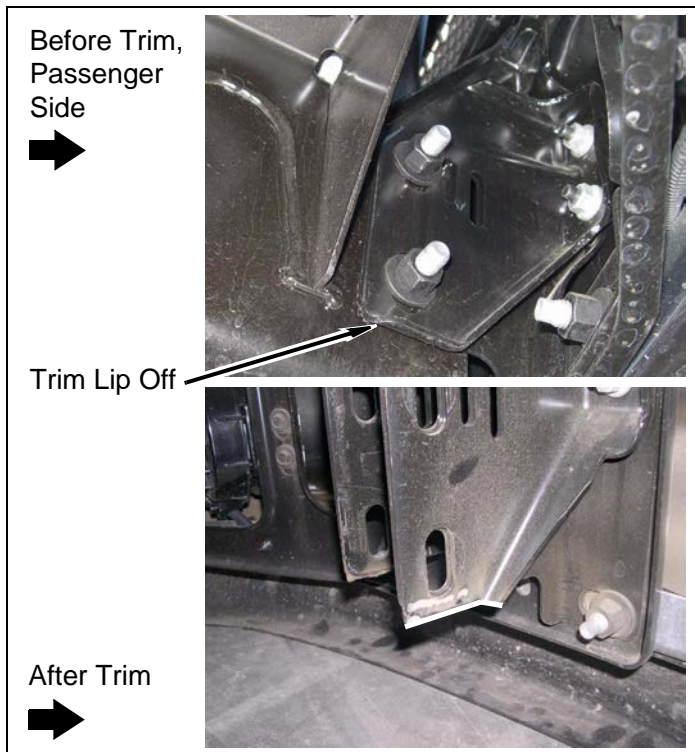

- e. Test fit front bumper on vehicle. If front bumper does not align, it may be necessary to trim one or both bolts indicated.
- f. Apply a few drops of *kit Loctite®* to threads of factory front bumper bolts.
- g. Position front bumper to frame. Ensure both edges of fender well fit on backside of bumper edge.

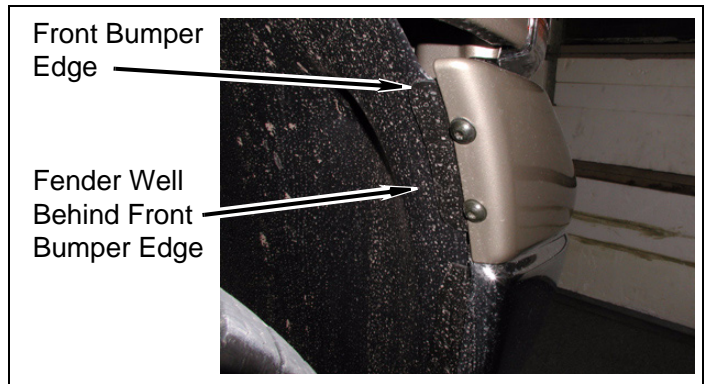

- h. Install front bumper and four **kit brackets** (front bumper) with two factory double bolt fasteners and four nuts. Snug hardware, but **DO NOT TIGHTEN**.

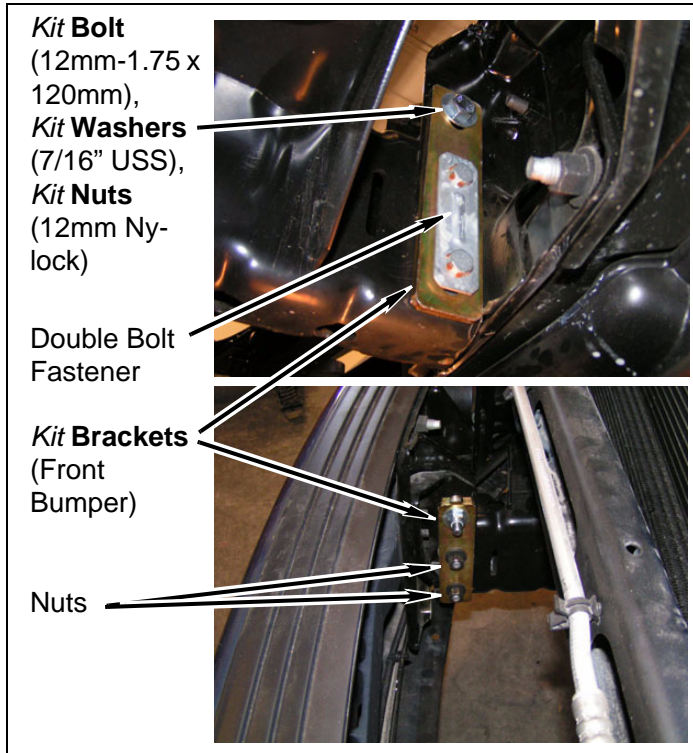

NOTE

It may be necessary to space factory double fasteners to compensate for **kit brackets** (front bumper). Do so with **kit washers** (7/16" USS) when required.

- i. **1500 Models:** Install two **kit spacers** (2-3/4" front bumper) between top holes of four **kit brackets** (front bumper) and factory bumper brackets with two **kit bolts** (12mm-1.75 x 120mm), four **kit washers** (7/16" USS) and two **kit nuts** (12mm Nylock). Snug hardware, but **DO NOT TIGHTEN**.

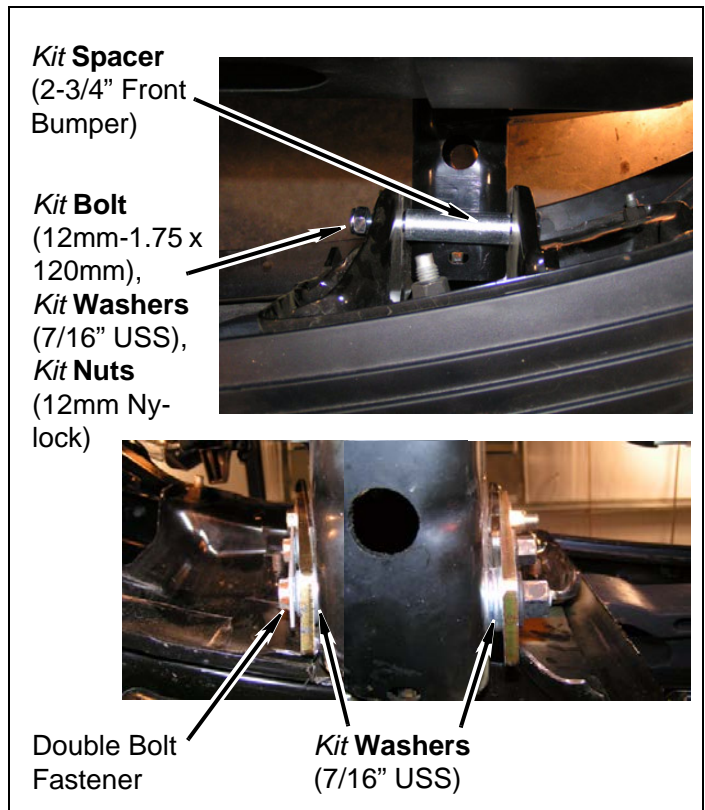

- j. **2500 Models:** Install two **kit spacers** (2-3/8" front bumper) between top holes of four **kit brackets** (front bumper) and factory bumper brackets with two **kit bolts** (12mm-1.75 x 120mm), four **kit washers** (7/16" USS) and two **kit nuts** (12mm Nylock). Snug hardware, but **DO NOT TIGHTEN**.

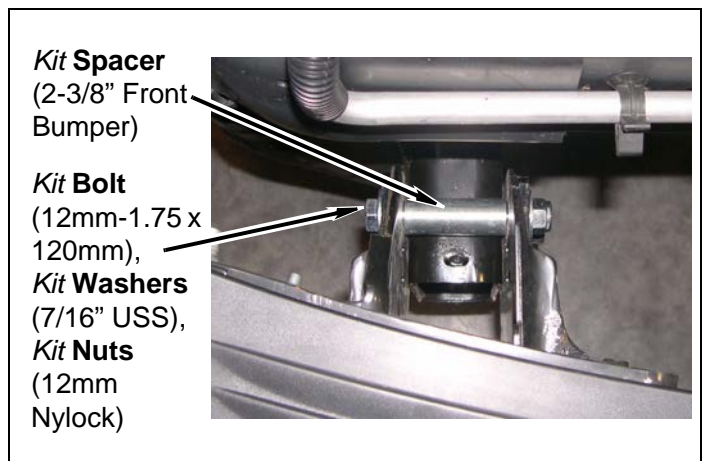

- k. Adjust bumper to fender until previous bumper-to-fender measurement is obtained. **TIGHTEN** bolts.

- I. Connect fog light harness at driver side of front bumper and install onto front bumper, if equipped.

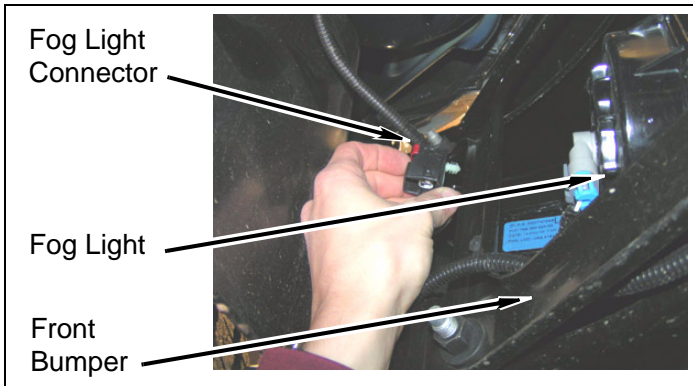

2. Connect both battery cables. Connect positive cable first, then negative cable.

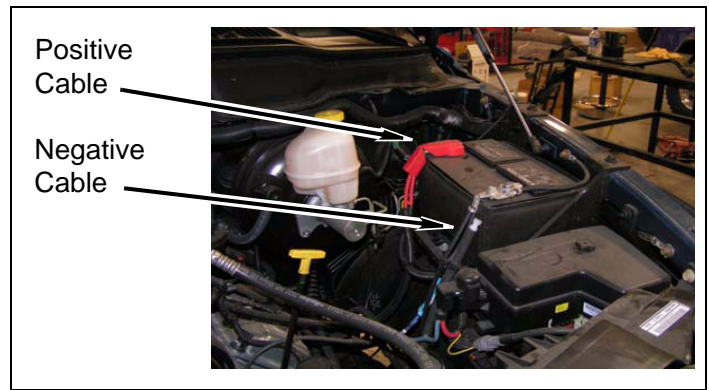

After Completing Installation

Engine Compartment

1. Airbag fuse

NOTE

The location of the airbag fuse may vary; check the owner's manual.

- a. Install airbag fuse(s).

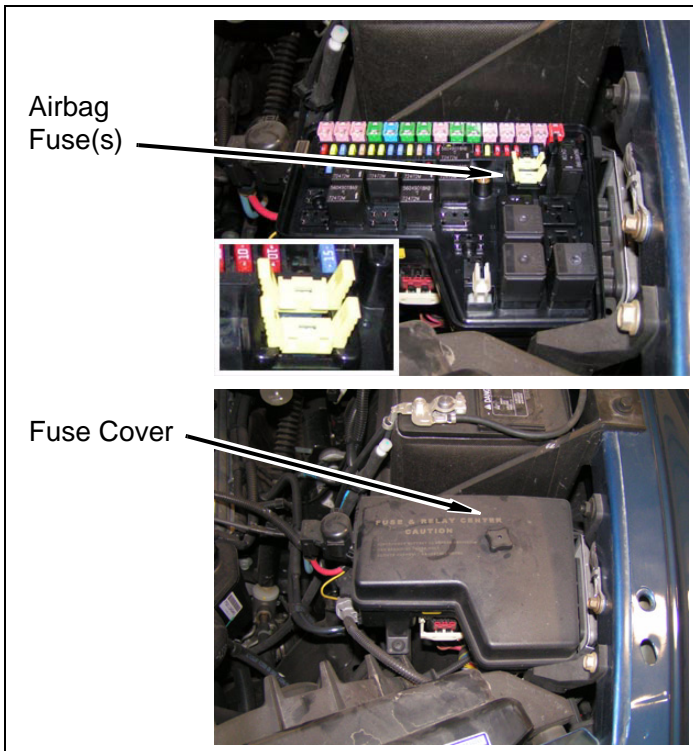

- b. Install fuse cover.

Miscellaneous

1. Apply *kit label* (warning) to dashboard in plain sight of all vehicle occupants.
2. Check all fasteners to ensure they are tight.
3. Ensure all wires, hoses, cables, etc. are properly connected and there is ample slack.

Dynamic Vehicle Check

1. Test-drive vehicle. Check steering in both directions to ensure that there is no bind. Check operation of clutch, brake system, and parking brake. Check operation of transmission and transfer case. Ensure there is full engagement in all gears and 4WD ranges. Check battery connections and electrical component operations.

⚠WARNING

Retorque all fasteners after 500 miles and after off road use. All body lift components should be visually inspected and fasteners retorqued during routine vehicle servicing.

⚠CAUTION

Performance Automotive Group does not recommend any particular wheel and tire combinations for use with its body lifts and cannot assume responsibility for the customer's choice of wheels and tires. Refer to your owner's manual for recommended tire sizes and warnings related to the use of oversized tires. Larger wheel and tire combinations increase stress and wear on steering and suspension components, which leads to increased maintenance and higher risk for component failure. Larger wheel and tire combinations also alter speedometer calibration, braking effectiveness, center of gravity, and handling characteristics. Consult an experienced local off road shop to find what wheel and tire combinations work best with your vehicle.

NOTE

All warranty information, instruction sheets, and other documents regarding the installation of this product must be retained by the vehicle owner. Information contained in the instructions and on the warranty card will be required for any warranty claims. The vehicle owner needs to understand the modifications made to the vehicle and how they affect vehicle handling and performance. Failure to provide the customer with this information can result in damage to the vehicle and severe personal injury.

Accessories

The following accessories are also available:

1500 Models: Kit # 6624: Gap Guards

2500/3500 Models: Kit # 6623: Gap Guards

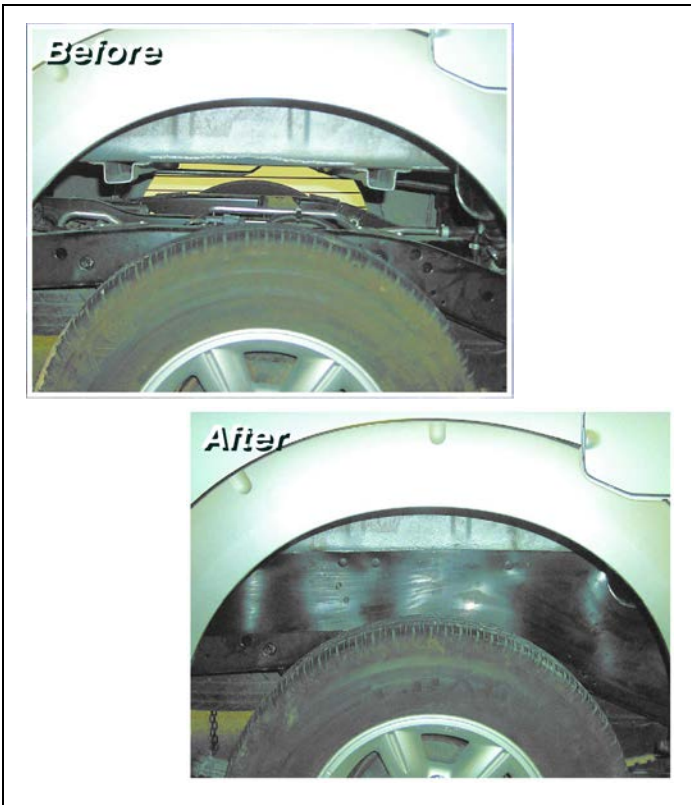

Kit Parts List

Qty. Description

16 **Block**, 3" x 3" spacer
 4 **Block**, 3" crush
 30 **Bolt**, 1/4"-20 x 1"
 1 **Bolt**, 3/8"-16 x 1-1/4" Allen head
 6 **Bolt**, 12mm-1.50x 100mm
 4 **Bolt**, 12mm-1.75 x 120mm
 8 **Bolt**, 12mm-1.75 x 180mm
 1 **Bolt**, 5/16" x 1"
 2 **Bolt**, 7/16" x 1-1/2"
 1 **Bolt**, 7/16" x 1"
 2 **Bracket**, 2" S-shaped
 1 **Bracket**, fan shroud, driver
 1 **Bracket**, fan shroud, passenger
 4 **Bracket**, front bumper
 1 **Bracket**, ground strap
 1 **Bracket**, ground strap, big hole
 1 **Bracket**, ground strap w/ stud
 1 **Bracket**, parking brake
 1 **Bracket**, rear bumper, driver
 1 **Bracket**, rear bumper, passenger
 1 **Bracket**, rear bumper, middle
 1 **Bracket**, spare tire ratchet tube
 1 **Bracket**, spare tire winch
 2 **Clamp**, #6 hose
 2 **Clamp**, #10 hose
 2 **Clamp**, #28 hose
 2 **Clamp**, #36 hose
 5 **Clip**, push

Qty. Description

1 **Extension**, fuel filler, metal
 1 **Extension**, fuel filler, 1/4" x 3" hose
 1 **Extension**, fuel filler, 5/8" x 4" hose, metal
 1 **Extension**, steering
 1 **Extension**, manual transmission shift lever
 1 **Gap guard**, fan shroud
 1 **Instruction** sheet
 1 **Label**, logo
 1 **Label**, warning
 1 **Label**, warning, rear bumper
 1 **Loctite®**, 6ml bottle
 35 **Nut**, 1/4" nylock
 4 **Nut**, 12mm nylock
 1 **Nut**, 5/16" nylock
 5 **Nut**, 7/16" nylock
 1 **Plate**, fan shroud, driver
 1 **Plate**, fan shroud, passenger
 2 **Spacer**, 1-1/2" power steering cooler
 2 **Spacer**, 2-3/4" front bumper
 2 **Spacer**, 2-3/8" front bumper
 1 **Tie**, zip
 60 **Washer**, 1/4" SAE
 2 **Washer**, 5/16" USS
 2 **Washer**, 7/16" SAE
 35 **Washer**, 7/16" USS

NOTE

Depending on the vehicle configuration (automatic or manual transmission, 2WD or 4WD, cab length, bed length, etc.), some parts may not be used.