



841 S. 71st Avenue • Phoenix, AZ 85043
(623) 907-0081
www.performanceaccessories.com

DODGE RAM 2500/3500 4WD
DIESEL ENGINE ONLY
(INCLUDING MEGA CAB)
3" BODY LIFT
INSTALLATION INSTRUCTIONS
2010-2012 KIT# PA60213

MANUAL TRANS. MODELS REQUIRE:
KIT# PASE9627

MANUAL TRANSFER CASE MODELS REQUIRE:
PASE9629

⚠ WARNING
Installation of a Performance Accessories body lift kit will change the vehicle's center of gravity and handling characteristics both on- and off-road. You must drive the vehicle safely! Extreme care must be taken to prevent vehicle rollover or loss of control, which could result in serious injury or death. Avoid sudden sharp turns or abrupt maneuvers and always make sure all vehicle occupants have their seat belts fastened.

⚠ WARNING
Before you install this kit, read and understand all instructions, warnings, cautions, and notes in this instruction sheet and in the vehicle owner's manual.

⚠ CAUTION
Proper installation of this kit requires knowledge of the factory recommended procedures for removal and installation of original equipment components. We recommend that the factory shop manual and any special tools needed to service your vehicle be on hand during the installation. Installation of this kit without proper knowledge of the factory recommended procedures may affect the performance of these components and the safety of the vehicle. We strongly recommend that a certified mechanic familiar with the installation of similar components install this kit.

⚠ WARNING
DO NOT combine suspension, body, or other lift devices. Use of vehicle with combined lifts may result in unsafe and/or unexpected handling characteristics.

⚠ WARNING
This kit should only be installed on a vehicle that is in good working condition. Before you install the kit, thoroughly inspect the vehicle for corrosion or deformation of the sheet metal around the factory body mounts. If the vehicle is suspected to have been in a collision or misused, do not install this kit. Off-road use of your vehicle with this kit installed may increase the stress applied to the factory body mounts. We do not recommend that any vehicle with a body lift kit installed be involved in any extreme off-road maneuvers such as jumping. Failure to observe this warning may result in serious personal injury and/or severe damage to your vehicle.

⚠ WARNING
Many states and municipalities have laws restricting bumper heights and vehicle lifts. Consult state and local laws to determine if the changes you intend to make to the vehicle comply with the law.

⚠ WARNING
The installation of larger tires may reduce the effectiveness of the braking system.

⚠ WARNING
Always wear eye protection when operating power tools.

⚠ WARNING
Before you install this kit, block the vehicle tires to prevent the vehicle from rolling.

⚠ WARNING
Accidental deployment of the air bag can result in serious personal injury or death. To avoid accidental deployment during installation of the kit, the Supplemental Restraint System (SRS, or airbag) must remain deactivated. Do not allow anyone near the airbag during installation. Refer to the factory service manual or owner's manual for the recommended procedure to disable the SRS. After you install the kit, reactivate the SRS before driving the vehicle.

NOTE
Performance Accessories recommends using the Loctite® supplied in the kit on the threads of all kit nuts and bolts unless specified otherwise in these instructions.

Before Starting Installation

NOTE

Kit parts are prefaced by the word *kit* and appear in **bold** print.

1. Carefully read all warnings and instructions completely before beginning.
2. Verify all parts have been received in this kit by checking the parts list at the end of this document.

NOTE

If parts are missing from kit, please be prepared to provide the following information:

1. **Name** of purchase location
2. **Bar Code** on side of box
3. **Date** above bar code
4. **Date** inside box cover
5. **Inspector #** from inside box cover

3. **Only install this kit on the vehicle for which it is specified.** If anytime during the installation you encounter something different from what is outlined in the instructions, call technical support at (928) 636-7080.
4. Special tools needed:
 - a. Welder or access to a professional welding shop.
 - b. Die grinder or similar tool capable of cutting metal.
5. Park vehicle on a clean, dry, flat, level surface and block tires so vehicle cannot roll in either direction.

Engine Compartment

1. Disconnect both battery cables to both batteries. Disconnect negative cables first, then positive cables.

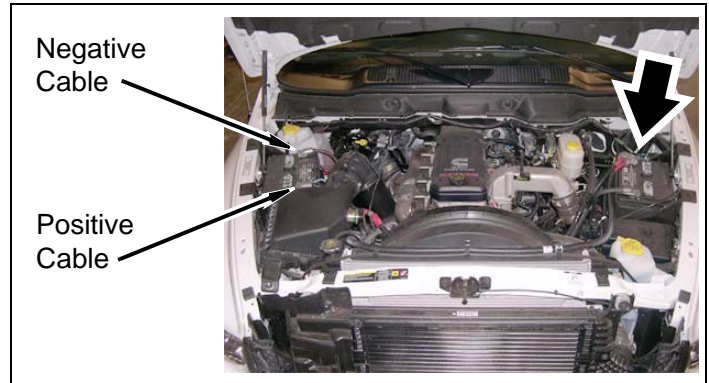

2. Airbag Fuse

NOTE

The location of the airbag fuse may vary; check the owner's manual.

- a. Remove fuse cover.
- b. Remove airbag fuse(s).

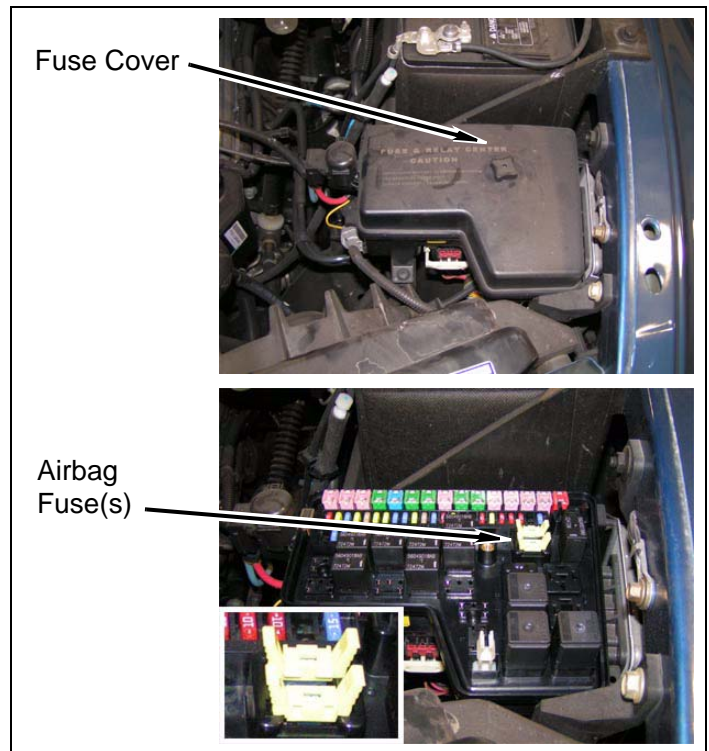

Prepare to Install Kit

Measurements

1. Measure and record distance between front bumper and fenders.

Driver Side _____ Passenger Side _____

2. Measure and record distance between rear bumper and bed.

Driver Side _____ Passenger Side _____

3. Measure and record distance between cab and bed.

Driver Side _____ Passenger Side _____

Front of Vehicle

1. Front grill

- a. Remove clips from front air shield and remove air shield from grill.
- b. Remove four bolts from grill and remove grill from core support.

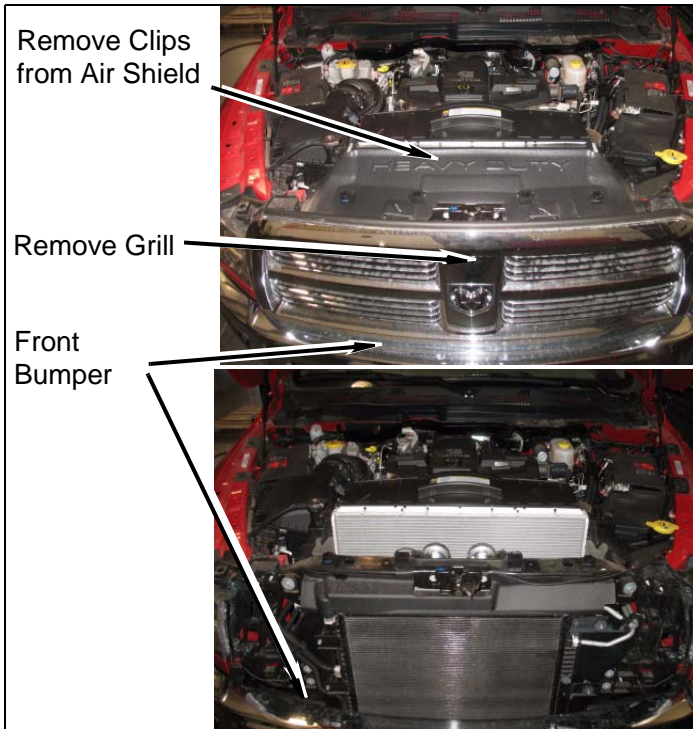

2. Front bumper

- a. Disconnect fog light harness at driver side of front bumper and pull connector off of front bumper, if equipped.

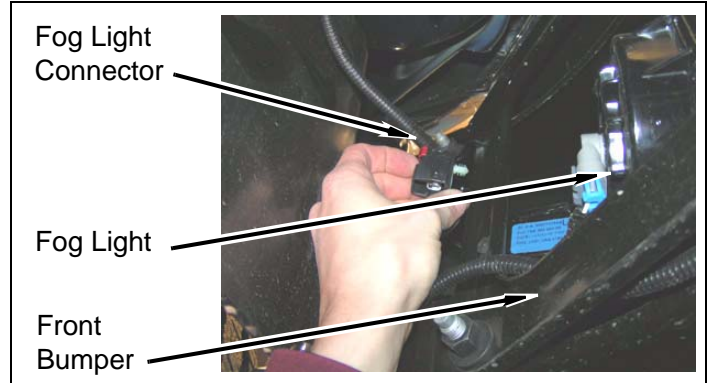

- b. Remove four nuts from two double bolt fasteners.

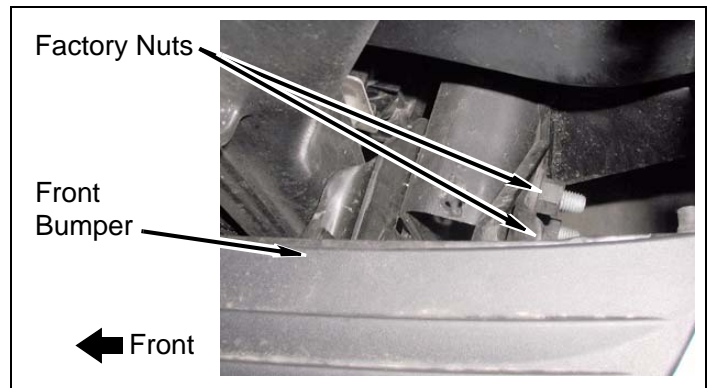

- c. Remove two bolts from top of intercooler and core support.

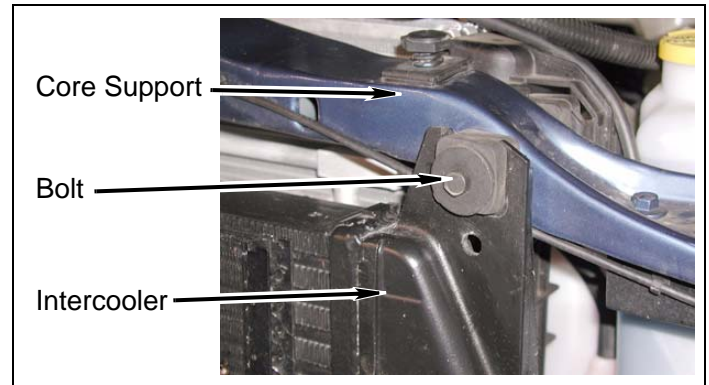

- d. Push bottom of intercooler forward toward front bumper and remove two double bolt fasteners and front bumper from vehicle.

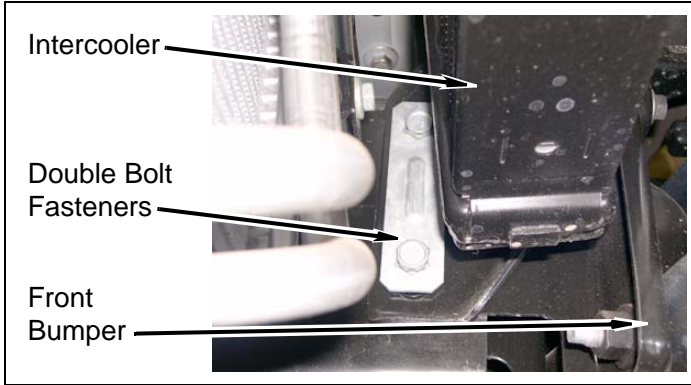

- d. Remove intercooler piping from intercooler to prevent binding or damage when installing body lift blocks.

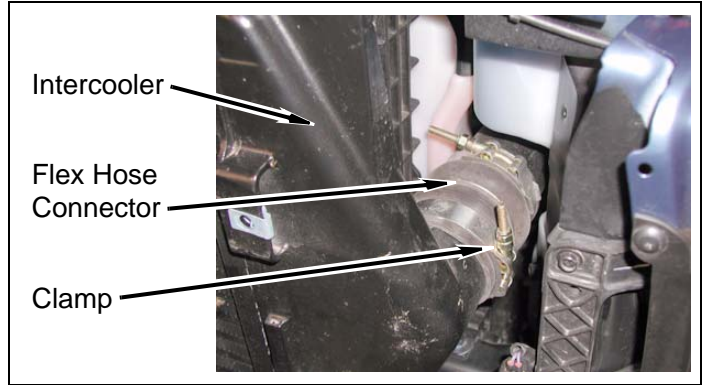

3. AC condenser and intercooler

- a. Remove three push clips and engine guard from core support.

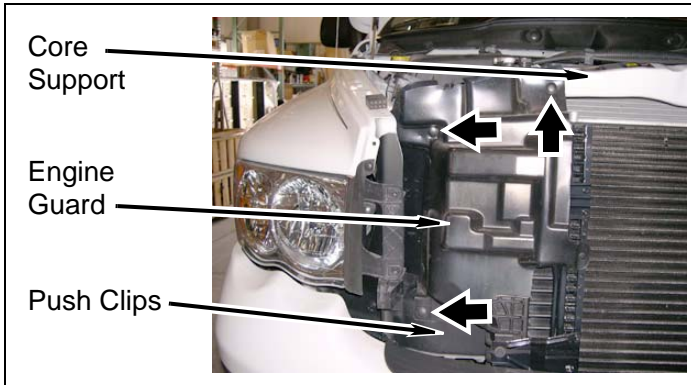

4. Transmission cooler models

- a. Remove two OEM bolts from transmission cooler and lower radiator.

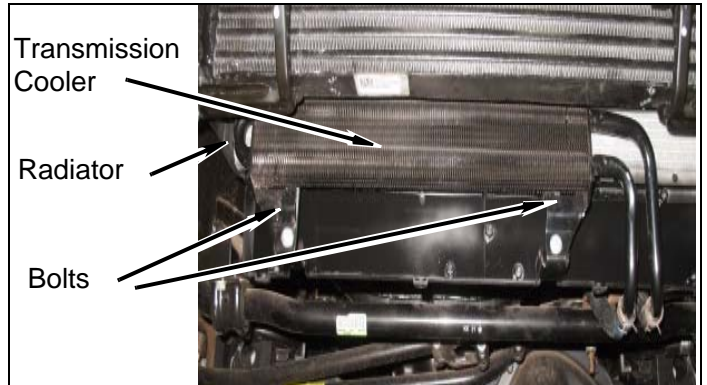

- b. Remove four bolts from AC condenser and intercooler. Support AC condenser.

- b. Carefully lower transmission cooler from radiator locking tabs.

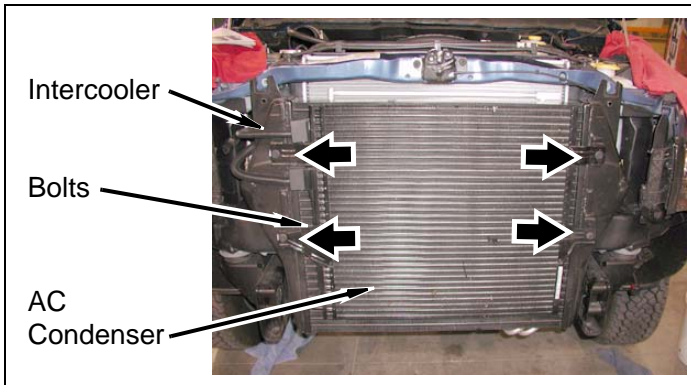

- c. Temporarily support transmission cooler with *kit tie* (zip).

5. Radiator Fan Shroud

- a. Remove fan shroud wire harness to fan clutch. Remove three bolts from fan shroud and prepare to remove fan shroud with engine fan. .

NOTE
DO NOT allow AC condenser to hang by AC lines or damage to the lines and/or condenser could result.

- c. Loosen all eight intercooler hose clamps on intercooler, piping and engine.

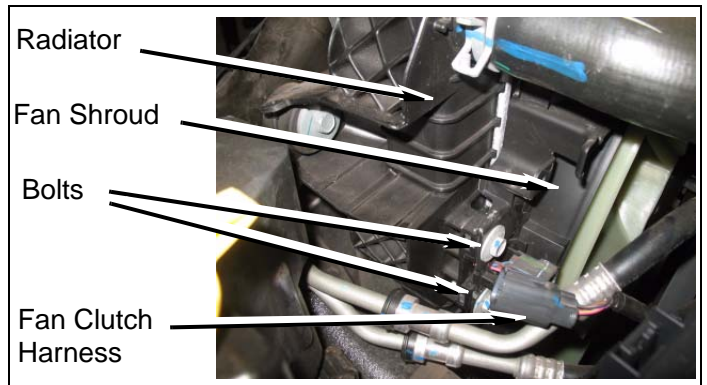

b. Using proper tool; remove fan from engine water pump.

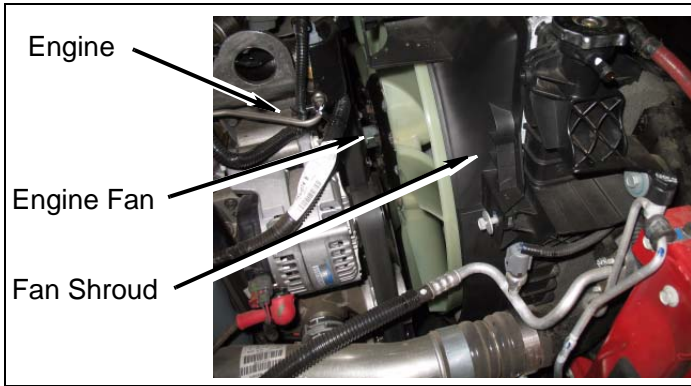

c. Remove fan shroud and engine fan as assembly from engine compartment.

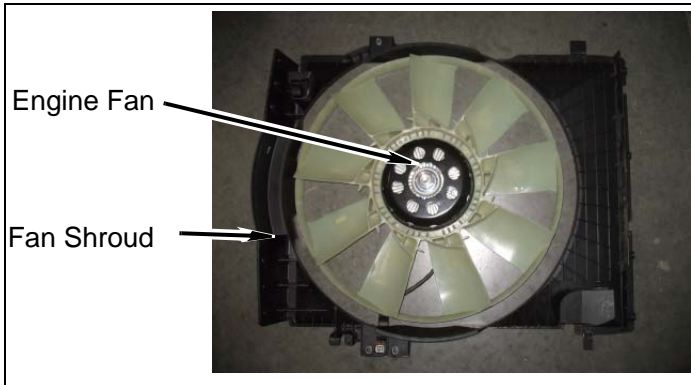

d. Remove wiring harness, three airbox cover clips, hose clamp, and airbox cover from airbox.

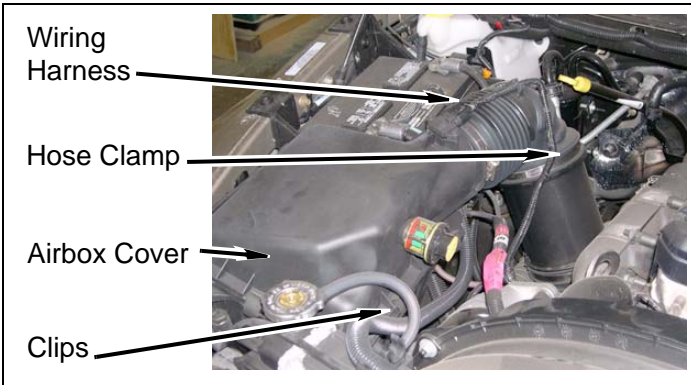

e. Remove radiator overflow hose from radiator.

f. Remove two transmission cooler lines from radiator bracket.

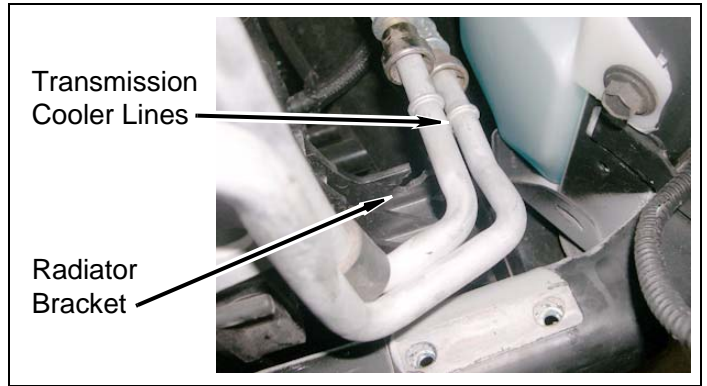

Engine Compartment

1. Airbox

a. Remove air filter from airbox.

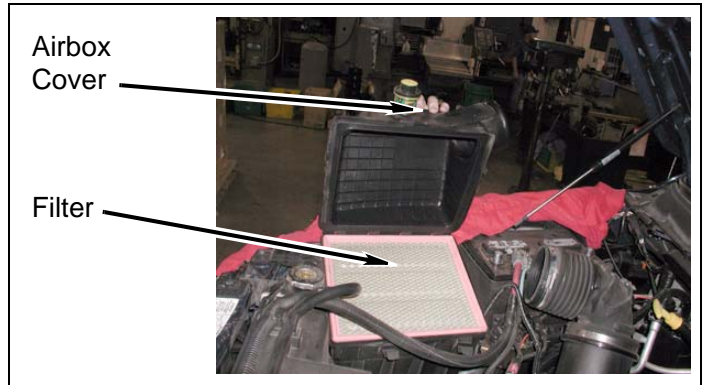

b. Remove nut and airbox from core support and battery box.

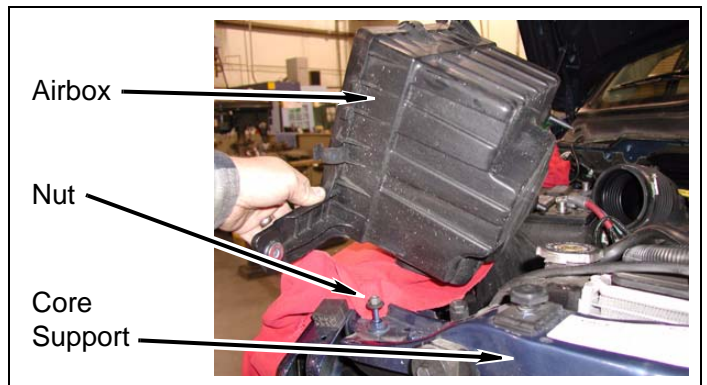

- c. Remove two push clip standoffs and AC line from passenger side core support.

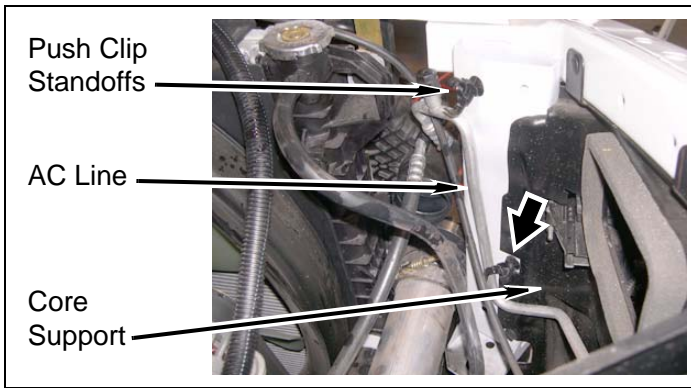

- c. Remove bolt and slide upper steering shaft up to separate from lower steering shaft.

- 3. Remove brake sensor wire harness from passenger and driver fender wells.

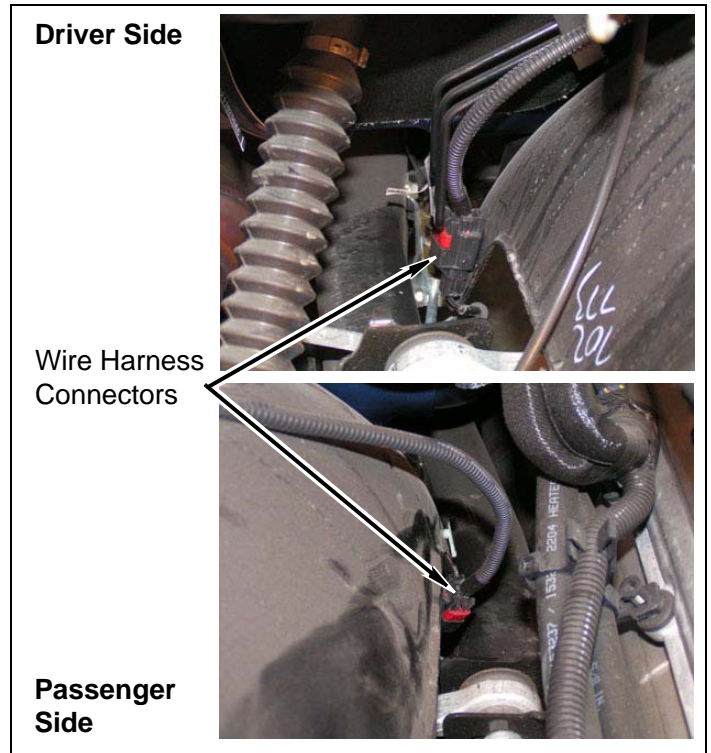

⚠ WARNING
DO NOT perform the following procedure until the engine is completely cool. Coolant may be extremely hot and could cause serious personal injury.

2. Steering Shaft

⚠ WARNING
Accidental deployment of the air bag can result in serious personal injury or death. To avoid accidental deployment during installation of the lift kit, the Supplemental Restraint System (SRS, or airbag) must remain deactivated. Do not allow anyone near the airbag during installation. Refer to the factory service manual or owner's manual for the recommended procedure to disable the SRS. After kit installation, the SRS must be reactivated before driving the vehicle.

⚠ CAUTION
If the following step is not performed, the airbag clock-spring could be damaged. Do not turn the steering wheel while the steering shaft is disconnected.

- a. Strap steering wheel to prevent accidental movement.
- b. Mark lower steering shaft in relation to upper steering shaft as shown.

- 4. Remove two push clips and block heater cord from passenger side frame, if equipped.

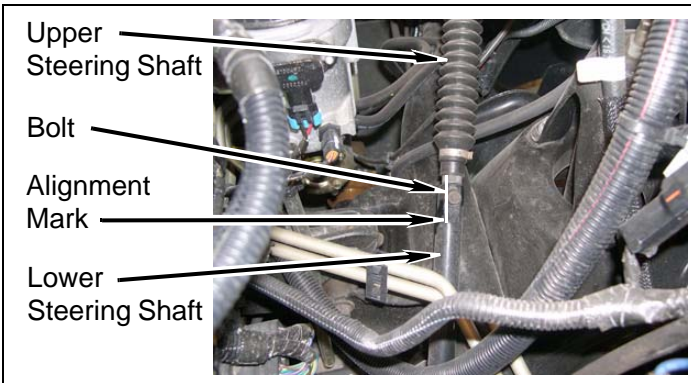
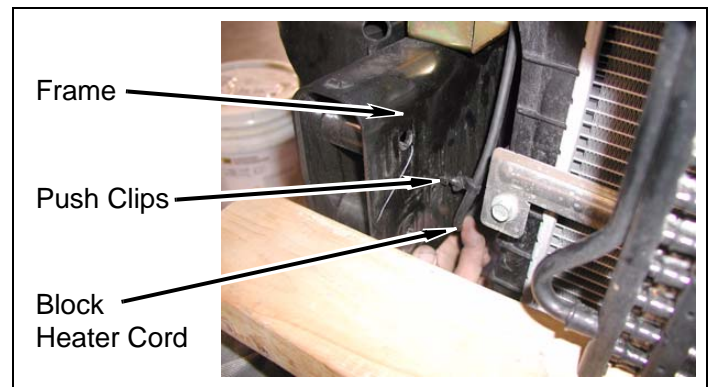

Underside of Vehicle

1. Remove bolts and brake line bracket from driver side frame.

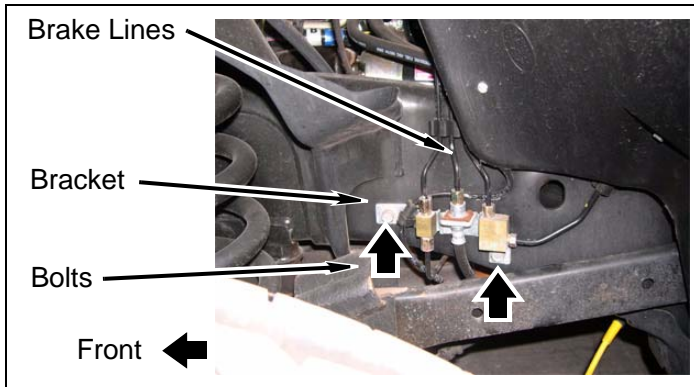

2. Remove bolt and ground strap from driver side frame.

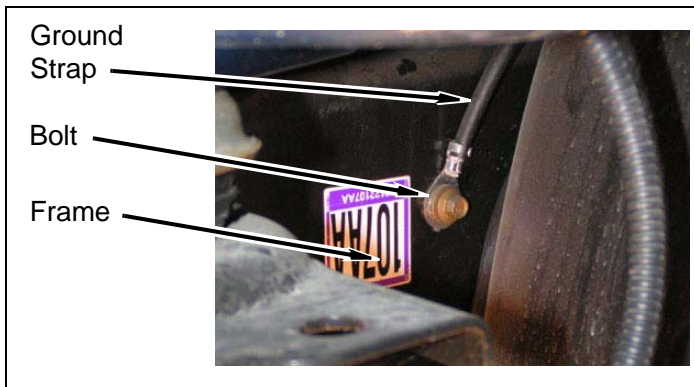

3. Remove nut and ground strap from stud on lower driver side firewall.

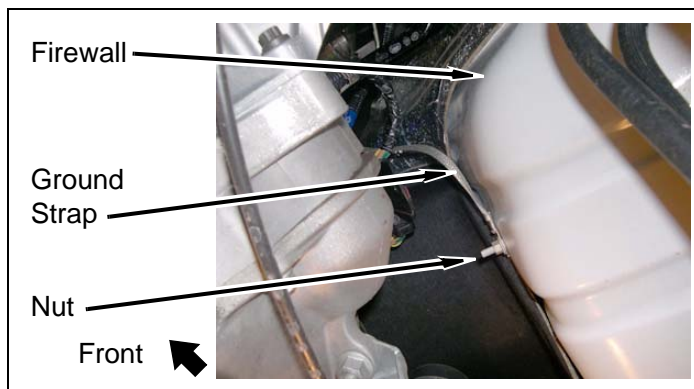

4. Remove push clip and wire harness from brackets on back of driver side engine.

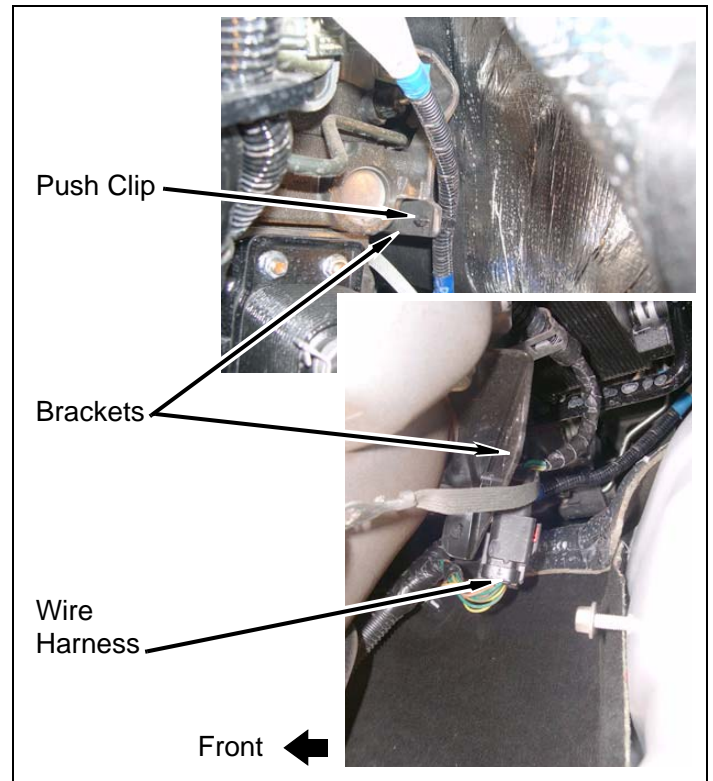

5. Remove harness from driver side body mount bracket.

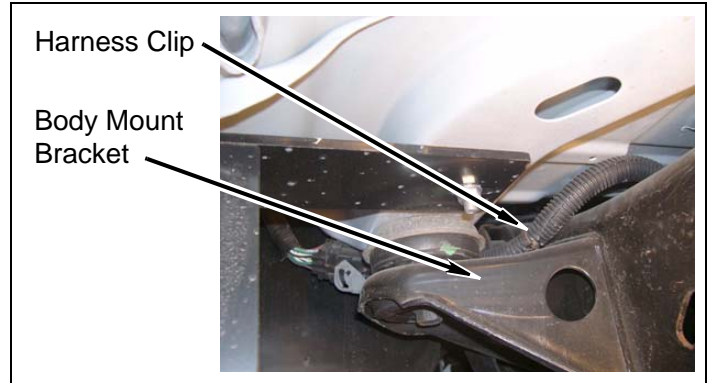

NOTE

The following procedures applies ONLY to automatic transmissions.

6. **Automatic transmission models:** Remove transmission shifter cable from clip on frame.

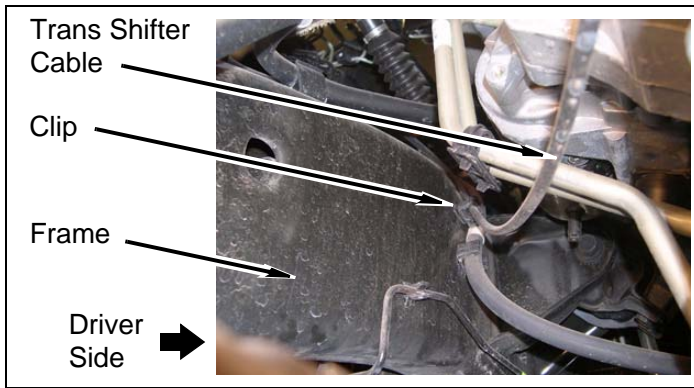

- a. Remove fuel cap from fuel filler.
b. Remove three bolts and fuel filler from body.

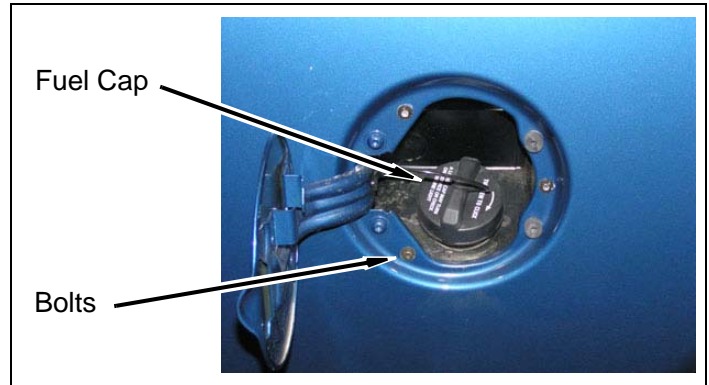

7. Parking brake cable

- a. Pull slack into parking brake cable. If necessary, attach locking pliers onto parking brake cable to allow slack.

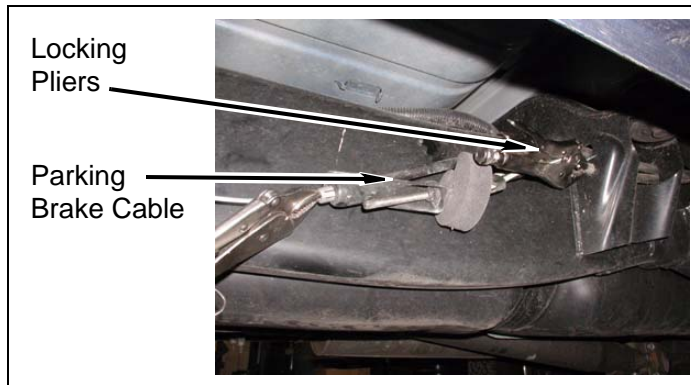

- b. Use expanding pliers and disconnect parking brake cable from junction.

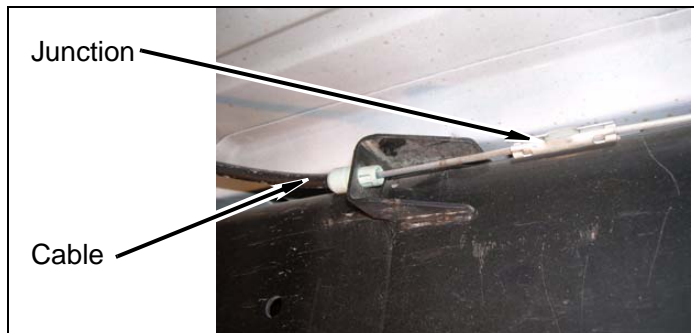

- c. Remove front parking brake cable from driver side parking brake cable mount.

8. Fuel filler

NOTE

The following procedures apply only to vehicles with manual transfer cases.

9. Manual transfer case

- a. Shift transfer case shift lever into 2H position.
b. Remove trunnion and shift rod from 4WD shift lever and transfer case input lever.

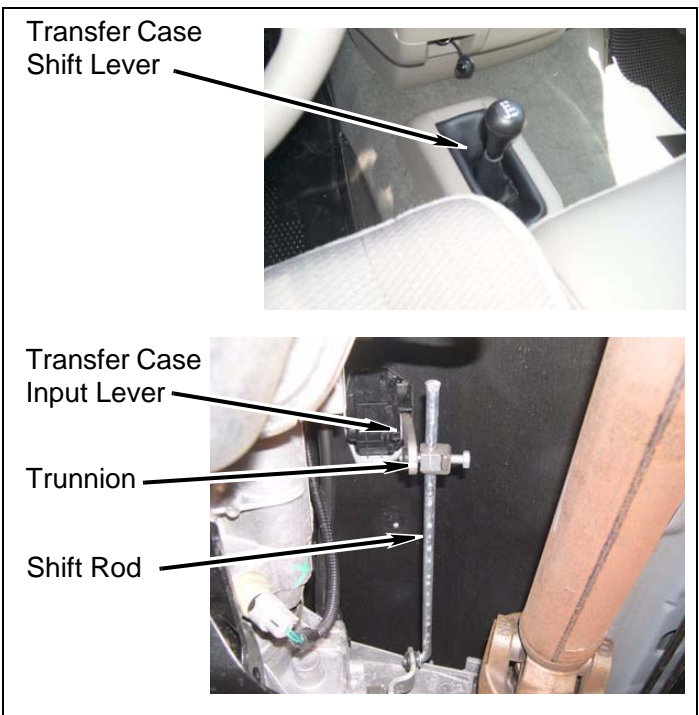

⚠ WARNING

Use extreme caution when working near fuel line(s) and fuel tank(s). Clean up spilled fuel immediately. Any spark could cause an explosion or fire resulting in serious personal injury and/or property damage.

Inside of Vehicle

1. **Some Models:** Manual transmission and transfer case shift levers

- a. Shift transmission into neutral and transfer case into 2H.
- b. Remove two caps, two nuts, and transmission and transfer case shift knobs.

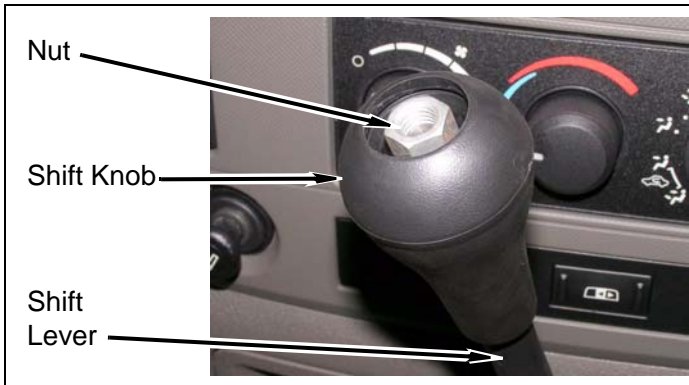

- c. Remove transfer case shift lever boot from center console.



- d. Remove cup holder inserts, three screws, and center console from floor.

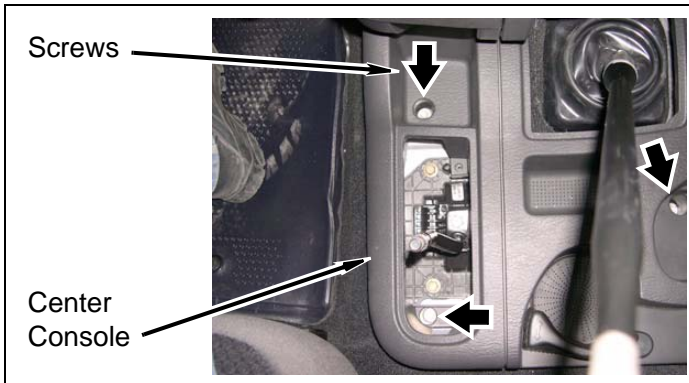

- e. Unscrew transmission shift lever from shift tower.

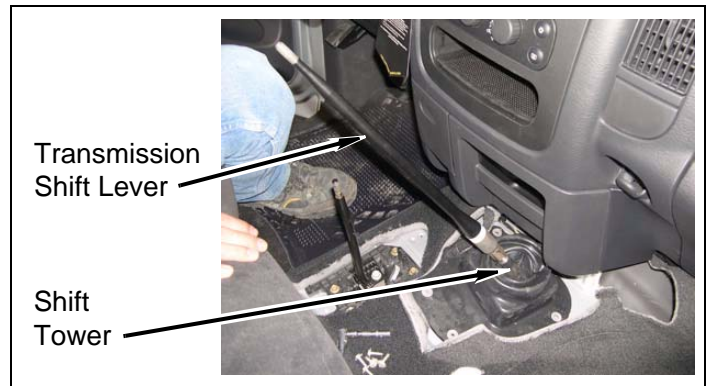

- f. Remove six bolts and shift lever boot seal from floor.

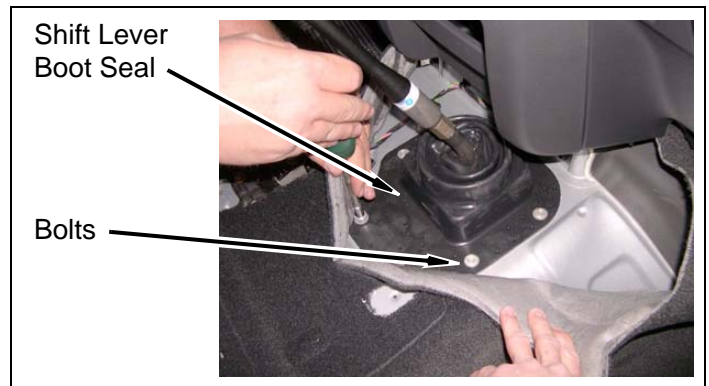

- g. Remove rubber cover from shift tower.

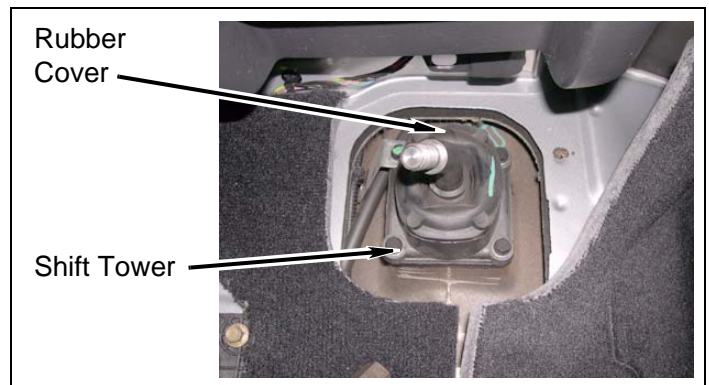

- h. Remove four Torx bolts from shift tower mounting plate.

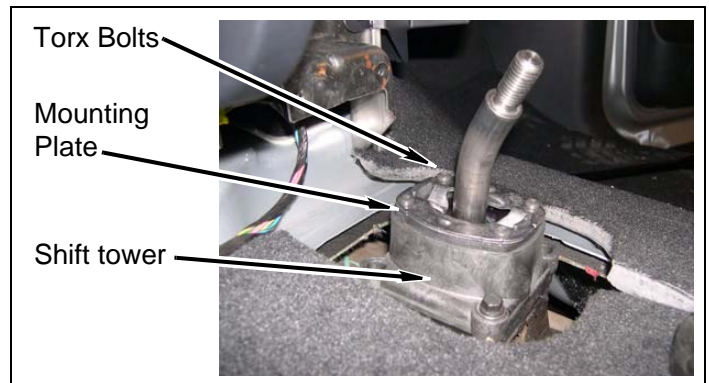

i. Remove shift lever from shift tower.

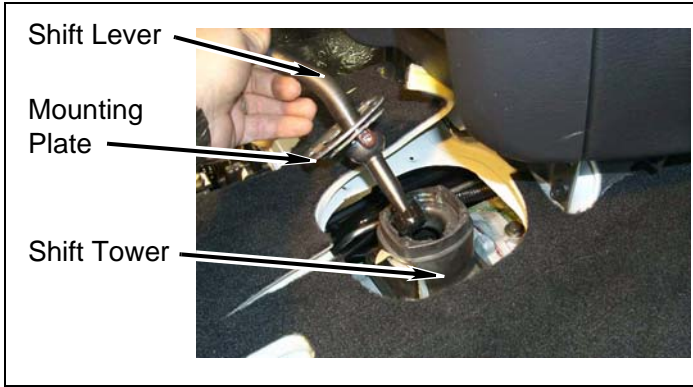

d. Remove cup holder inserts, three screws, and center console from floor.

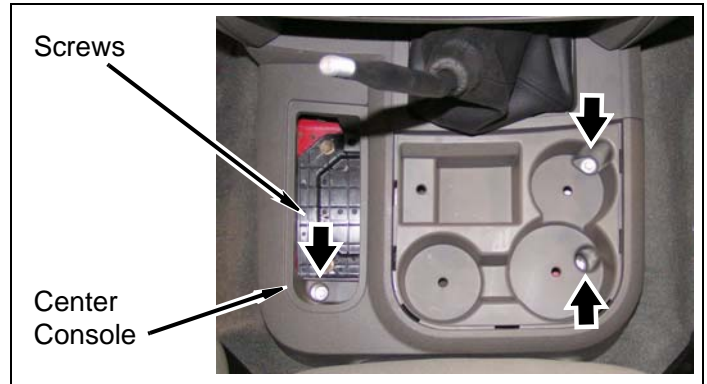

2. **Some Models:** Manual transmission and transfer case shift levers

a. Shift transmission into neutral and transfer case into 2H.

b. Remove two caps, two nuts, and transmission and transfer case shift knobs.

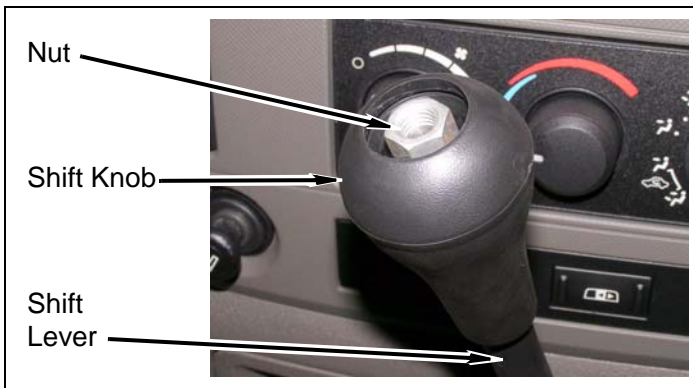

e. Remove manual transmission shift lever boot from shifter console.

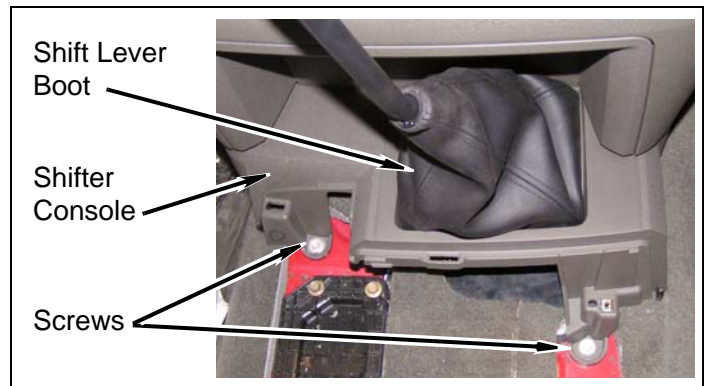

c. Remove transfer case shift lever boot from center console.

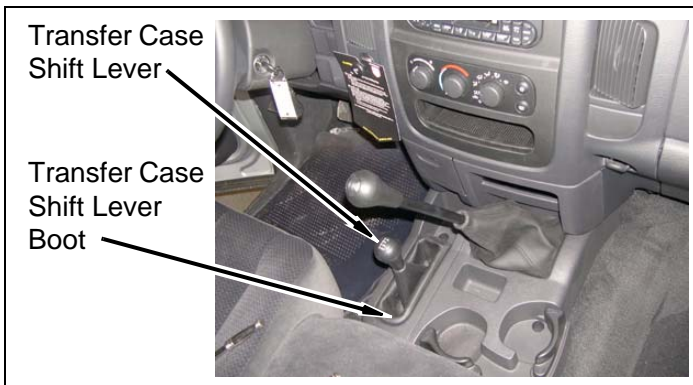

f. Remove two screws and slide shifter console from vehicle.

g. Remove six bolts and shift lever boot seal from floor and shift lever.

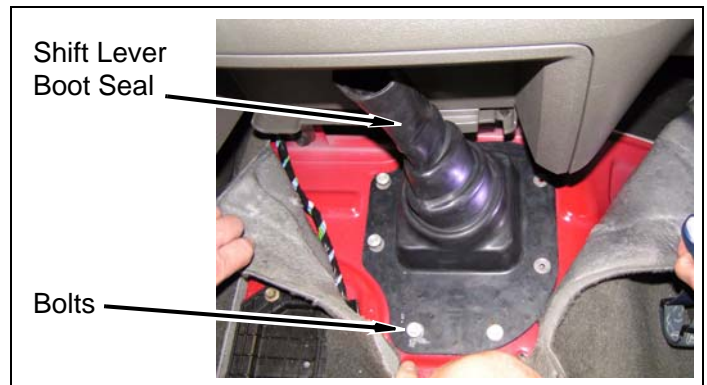

h. Remove two nuts and manual transmission shift lever from shift tower.

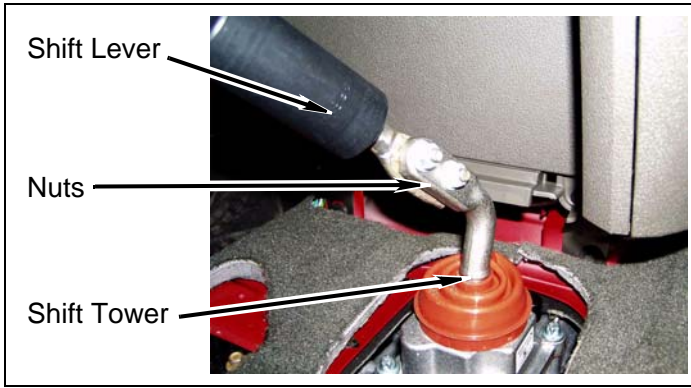

c. Remove two bolts from center of bumper.

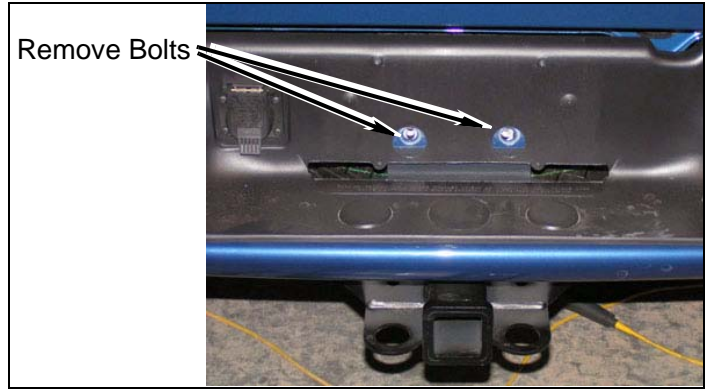

d. Remove four bolts from bumper and frame.

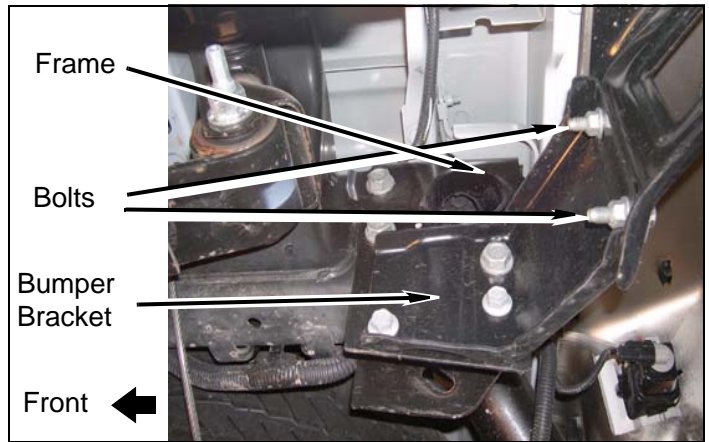

Rear of Vehicle

1. Rear bumper

a. Disconnect wire harnesses from rear bumper.

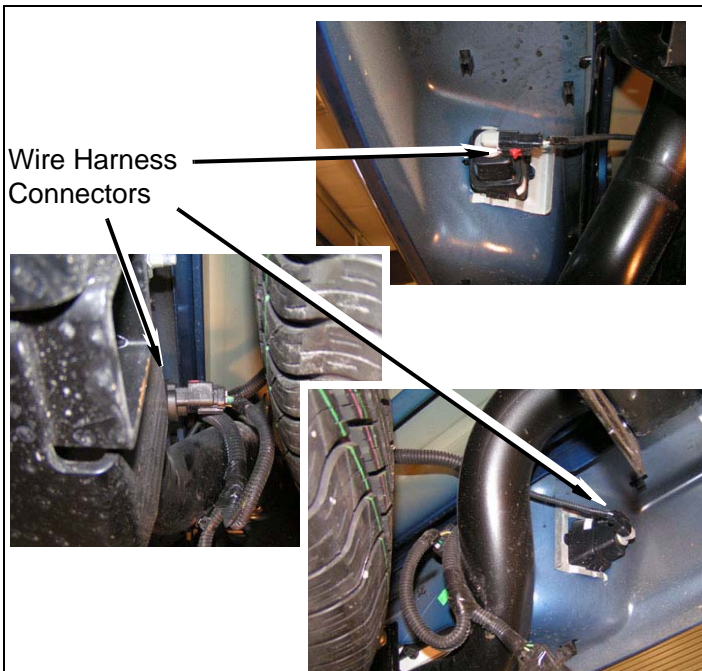

b. Remove two screws and license plate.

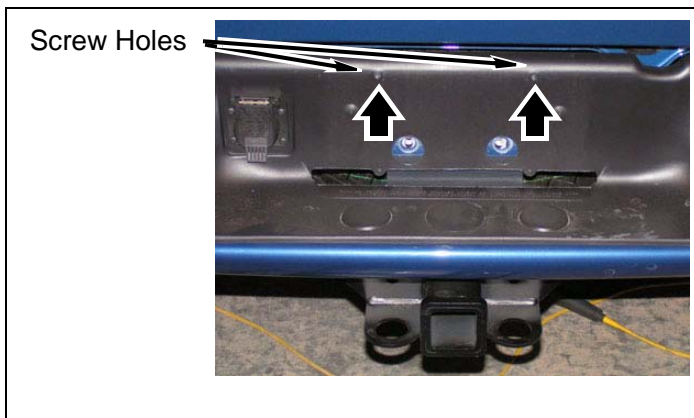

2. Spare tire winch

- a. Lower spare tire onto ground and remove (see owner's manual for procedure).



- b. Remove retaining clip and ratchet tube from spare tire winch mechanism.

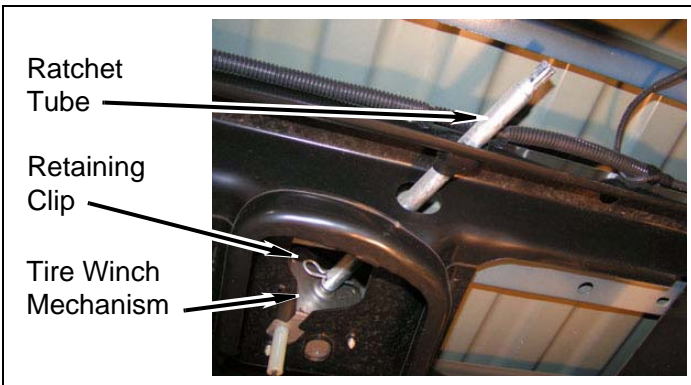

- c. Remove plastic ratchet tube guide from cross-member.

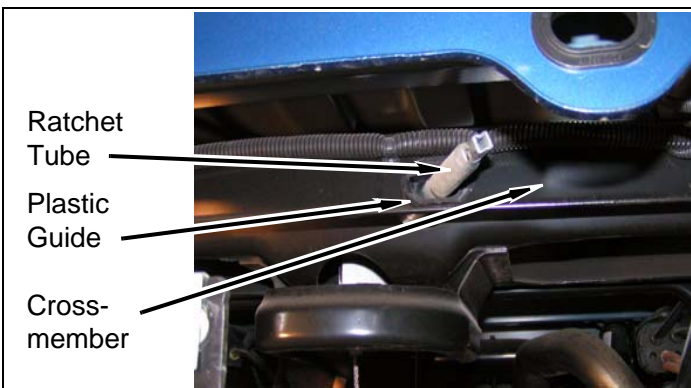

Install Kit

Cab

1. Prepare to lift cab from frame

- a. Loosen, but DO NOT REMOVE, cab mounting bolts on driver side.

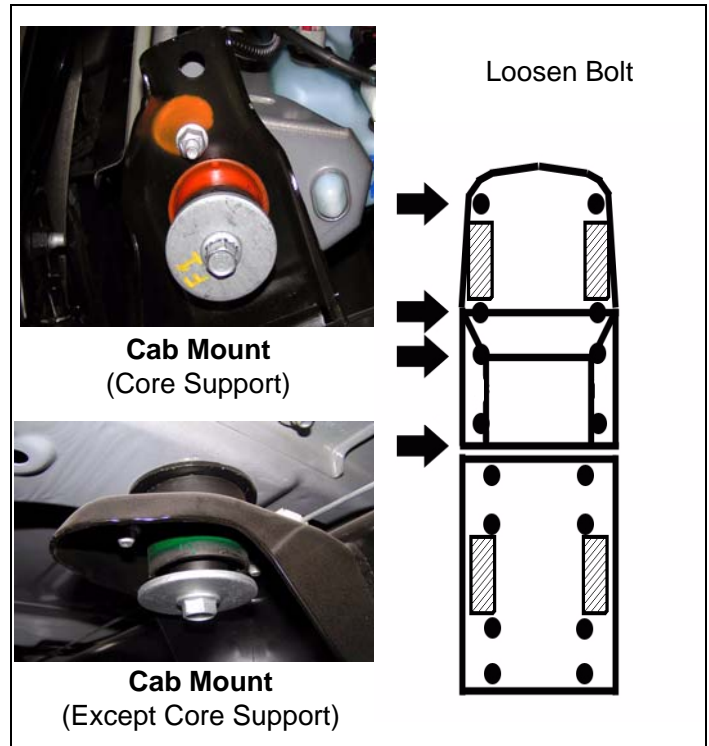

NOTE

The number of cab mounting bolts may vary with the length of the cab.

- b. Remove bolt and lower bushing from each cab mount on passenger side.

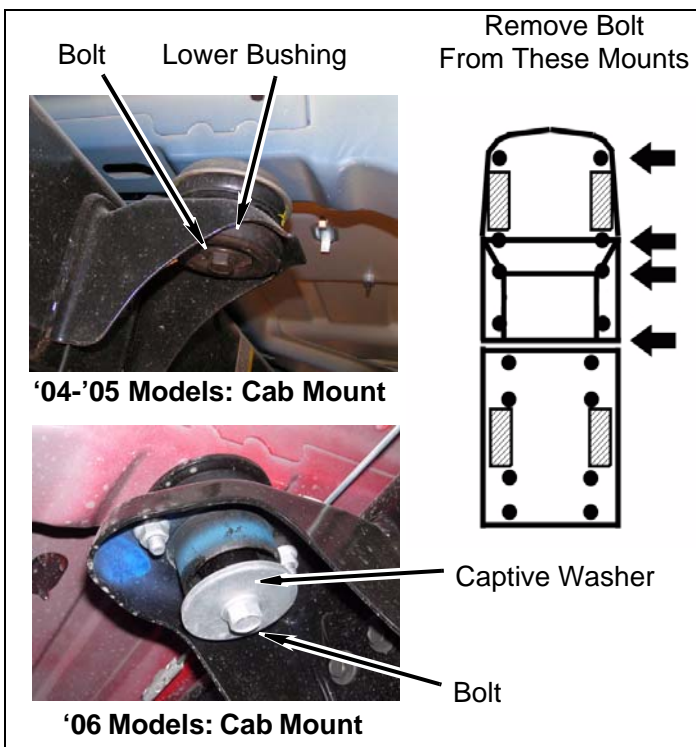

2. Cab passenger side

- a. Remove captive washer from each cab mounting bolt.

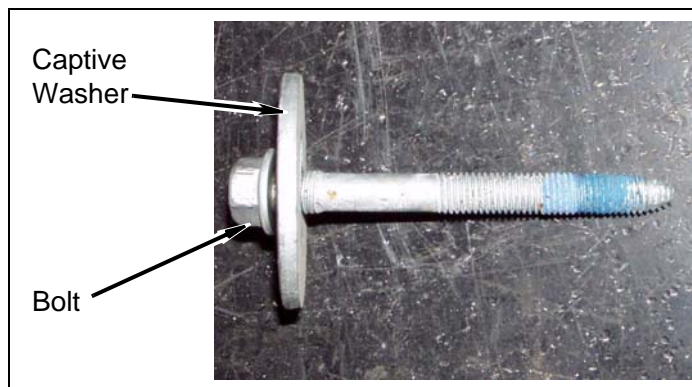

NOTE

The OE cab mounting bolt captive washers will be used in the installation of this kit. DO NOT discard captive washers.

- b. Position hydraulic jack and wood block under passenger side of cab (under the body seam). Slowly lift cab just enough to install **kit block** on top of factory upper bushing.

⚠ WARNING

Use extreme caution when lifting body from frame. To prevent serious personal injury, ensure the lifting device is securely placed. Keep your hands out from between the body and frame.

⚠ CAUTION

Continually check hoses, wires, lines, etc. to be sure that everything is flexing properly and not binding, or damage to the vehicle could result. Be especially careful of the a/c hoses at the fire wall, the belt pulley, and at the core support. Ensure brake lines stretch while lifting. Bending the lines to gain ample slack may be necessary. Be extremely careful not to kink the lines.

⚠ WARNING

The **kit blocks** must be installed in addition to the factory upper and lower bushings. Installing the **kit blocks** without the factory upper and lower bushings could result in damage to the vehicle or serious personal injury.

- c. Install **kit block** onto metal cups and upper bushings of each cab mount.

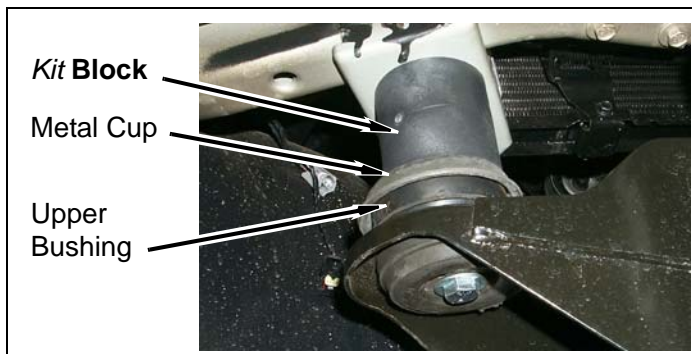

- d. Lower passenger side cab onto **kit blocks**.

- e. **Front Cab Mounts:** Install *kit bolt* (12mm x 180mm) into each cab mount. DO NOT TIGHTEN.

- c. Remove each *kit bolt*, one at a time, and apply small amount of *kit Loctite®* onto threads. Install *kit bolt*, and captive washer. TIGHTEN *kit bolts* to 75 ft. lbs.

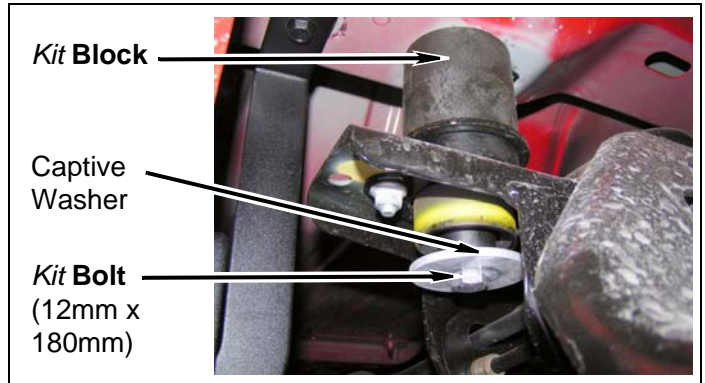
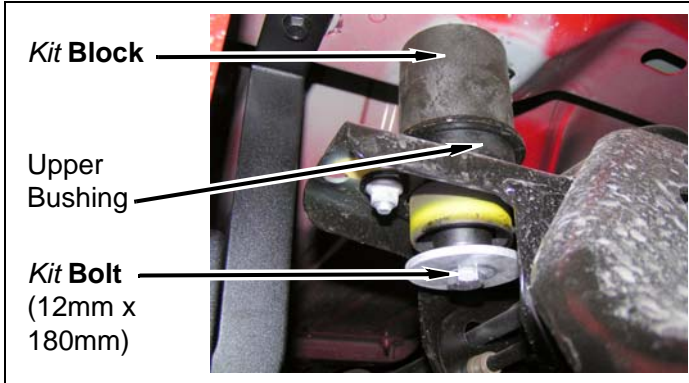

- f. **Rear Hydro Cab Mount:** Install lower bushing and *kit bolt* (12mm x 220mm) into each rear cab mount. DO NOT TIGHTEN.

Bed

- 1. Prepare to lift bed from frame

- a. Loosen, but DO NOT REMOVE, bed mounting bolts on driver side.

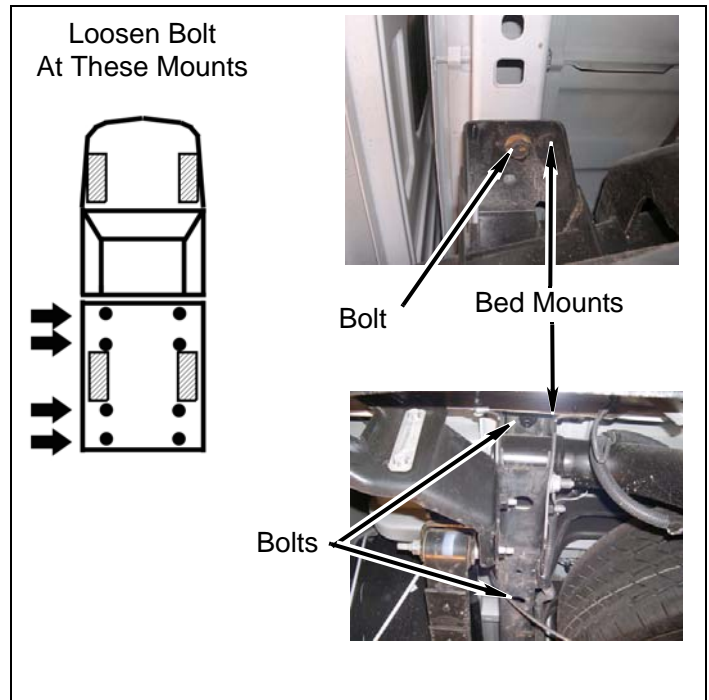
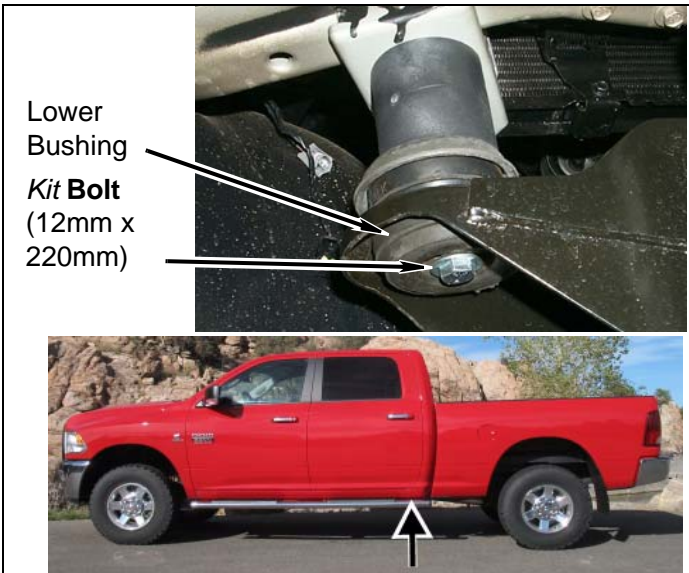

NOTE
The number of bed mounting bolts may vary with the length of the bed.

- 3. Cab driver side

- a. Repeat previous steps to driver side of cab.
- b. Set cab-to-bed spacing according to previous measurement.

2. Remove bolt from each bed mount on passenger side.

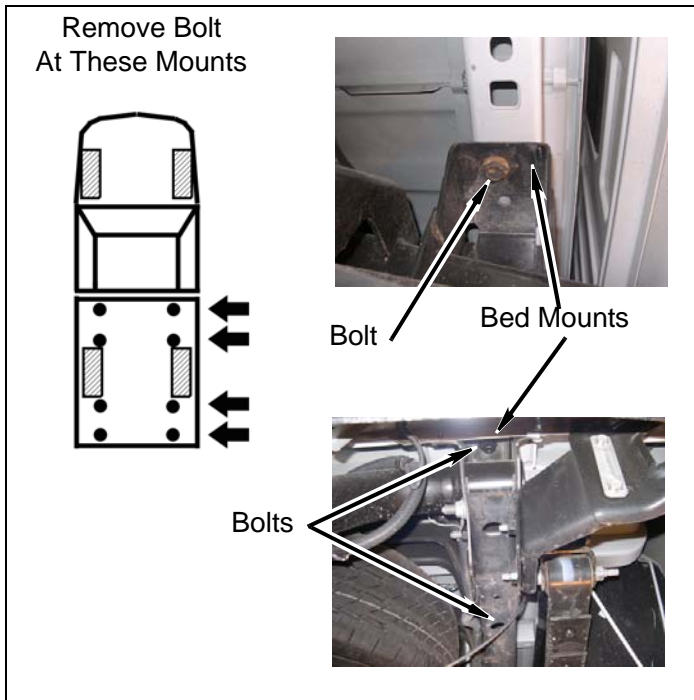

- b. Install *kit block* onto rear frame mount.

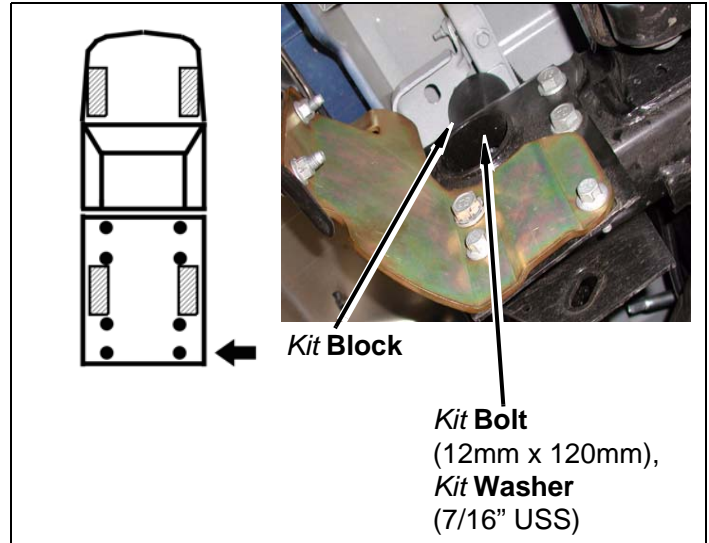

- c. Install *kit blocks* onto two (or three) other frame mounts.

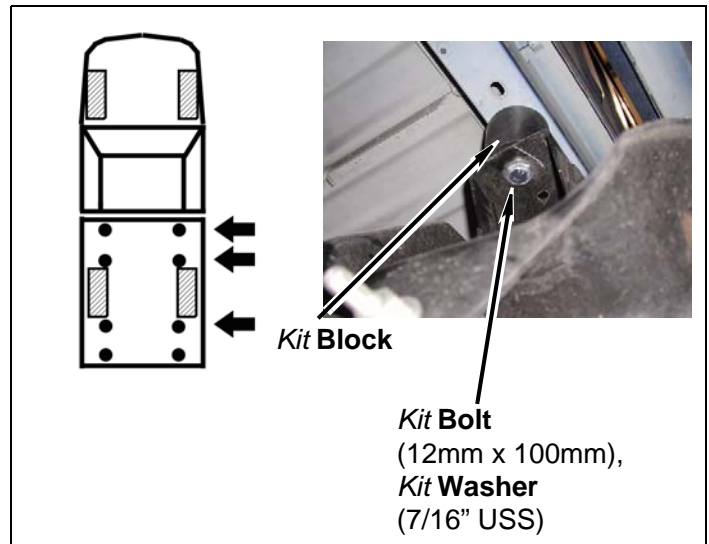

- d. Lower bed onto *kit blocks*.

- e. At rear bed mount, install *kit bolt* (12mm x 120mm) and *kit washer* (7/16" USS). DO NOT TIGHTEN.

- f. At other bed mounts, install *kit bolts* (12mm x 100mm) and *kit washers* (7/16" USS). DO NOT TIGHTEN.

3. Bed passenger side

- a. Using a hydraulic jack and wood block, slowly lift bed just enough to install *kit block* onto frame.

⚠ WARNING
Use extreme caution when lifting the bed from the frame. To prevent serious personal injury, ensure the lifting device is securely placed. Keep your hands out from between the bed and frame.
⚠ CAUTION
To prevent damage to the vehicle while lifting the bed, continually check hoses, wires, brake lines, etc. to ensure everything is flexing properly and not binding. Ensure clearance between bed and cab is maintained.

4. Bed driver side

- a. Repeat previous steps on driver side of bed.
- b. Set bed-to-cab spacing according to previous measurement.

- c. Remove each *kit bolt*, one at a time, and apply small amount of *kit Loctite®* onto threads. Install *kit bolt* with *kit washer* (7/16" USS). TIGHTEN *kit bolts* to 55 ft. lbs.

- d. Turn *kit bracket* (spare tire winch) toward front of vehicle and slide spare tire winch cable through slot in *kit bracket* (spare tire winch).

Rear of Vehicle

1. Spare tire winch

- a. Remove two bolts and spare tire winch from crossmember.

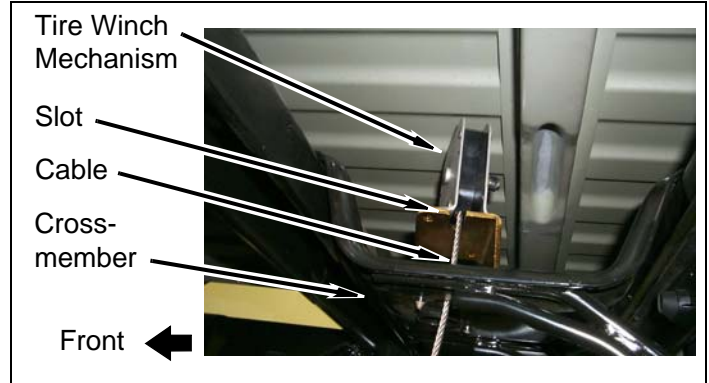
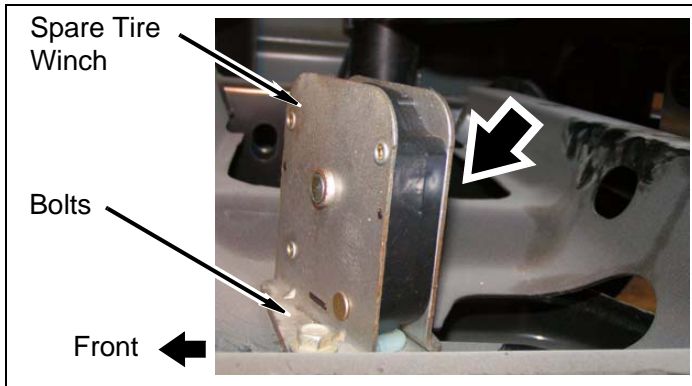

- e. Install *kit bracket* (spare tire winch) onto cross-member with factory passenger side bolt and TIGHTEN both passenger and driver side bolt.

- f. Install spare tire winch onto *kit bracket* (spare tire winch) with two *kit bolts* (5/16" x 1"), four *kit washers* (5/16" SAE), and two *kit nuts* (5/16" Nylock).

- b. Install *kit bracket* (spare tire winch) onto cross-member with factory driver side bolt. DO NOT TIGHTEN.

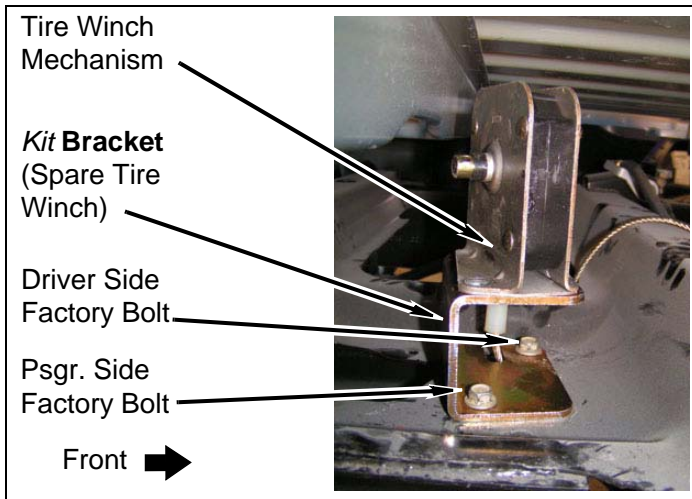
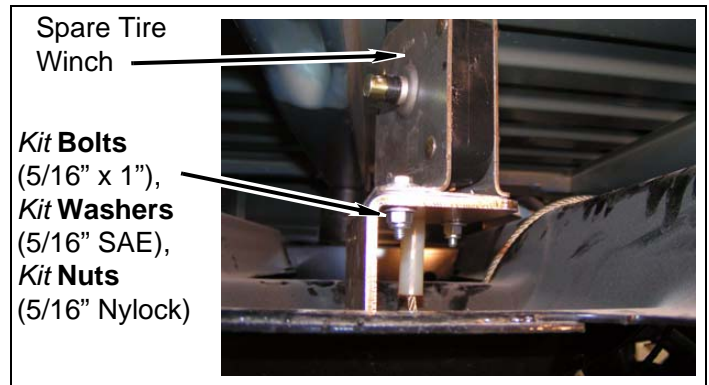

- g. Remove two wire loom clips from crossmember.

- c. Install spare tire winch through hole in cross-member. Position spare tire winch onto *kit bracket* (spare tire winch).

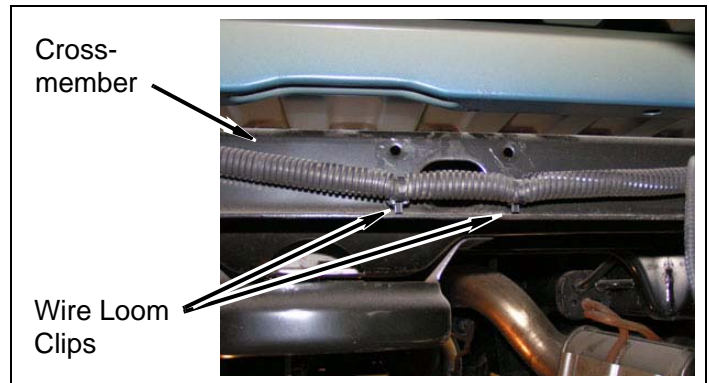

- h. Install **kit bracket** (spare tire ratchet tube) onto crossmember with two **kit bolts** (1/4" x 3/4"), four **kit washers** (1/4" SAE), and two **kit nuts** (1/4"-20 Nylock). Install plastic ratchet tube guide into **kit bracket** (spare tire ratchet tube).

- k. Verify ratchet tube is visible through hole in bed and plastic ratchet tube guide. Adjust **kit bracket** (spare tire ratchet tube), if necessary.

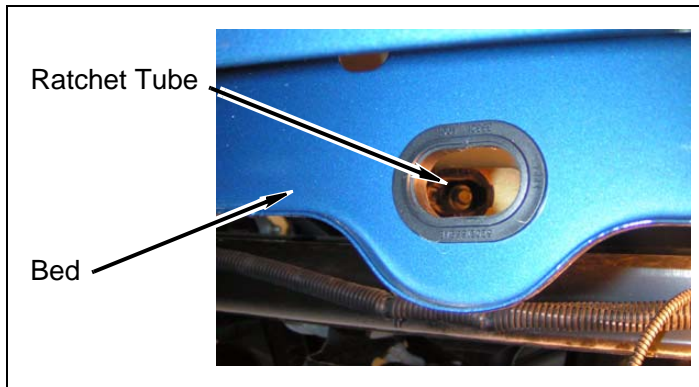
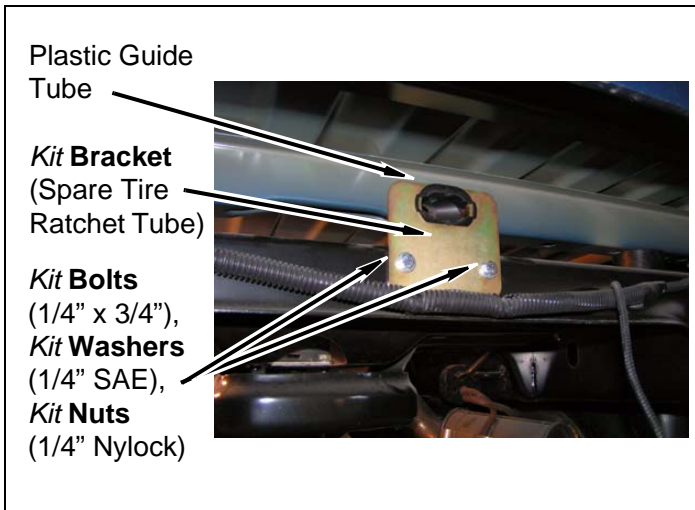

- i. Install ratchet tube onto spare tire winch with retaining clip.

- l. Install spare tire onto vehicle (see owner's manual).

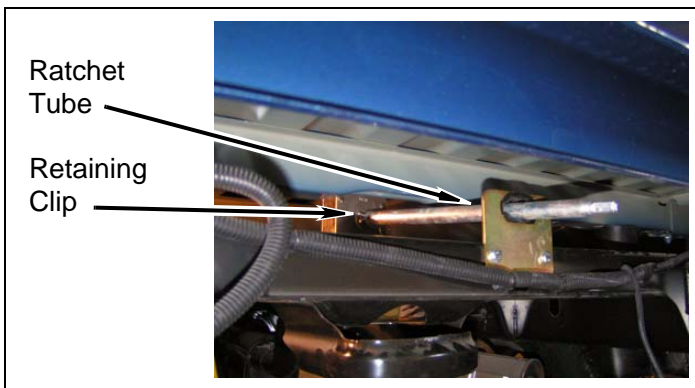

2. Rear bumper

- j. Install wire harness onto crossmember with **kit tie** (zip).

⚠ WARNING

The following procedure is intended only to enhance the appearance of the vehicle. The rear bumper will no longer be rated for towing of any kind. Towing with the rear bumper after it has been lifted can result in death, serious personal injury, or damage to the vehicle. Towing after the bumper has been lifted should be accomplished using a rated Class III receiver type hitch.

- a. Apply small amount of **kit Loctite**® onto threads of factory bolts. Install **kit bracket** (rear bumper, middle) onto trailer hitch with two factory bolts. **DO NOT TIGHTEN.**

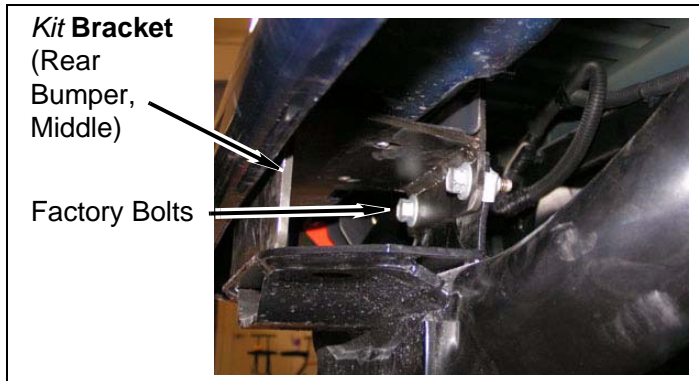
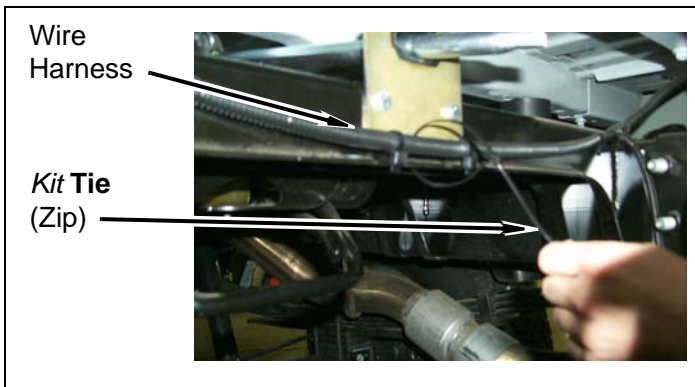

- b. Using a cut off wheel remove both rear bumper mounting pins.

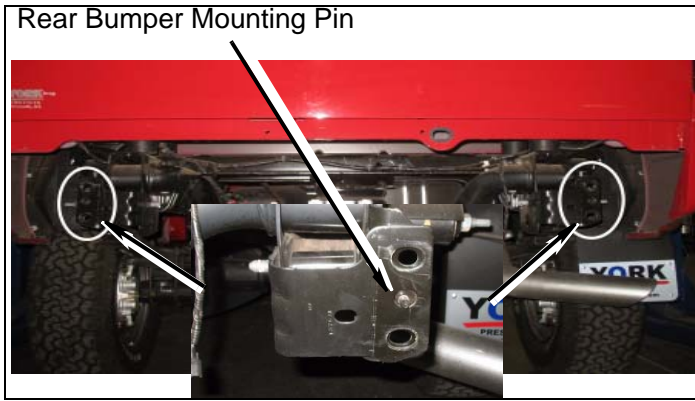

- c. Apply small amount of *kit* Loctite® onto threads of factory bolts. Install two *kit* brackets (rear bumper) onto frame and bumper with two factory bolts and nuts with captive washers and two *kit* bolts (1/2" x 1-1/4") and install rear bumper onto *kit* bracket (rear bumper, middle) with two *kit* bolts (7/16" x 1-1/2"), four *kit* washers (7/16" USS), and two *kit* nuts (7/16" Nylock). DO NOT TIGHTEN.

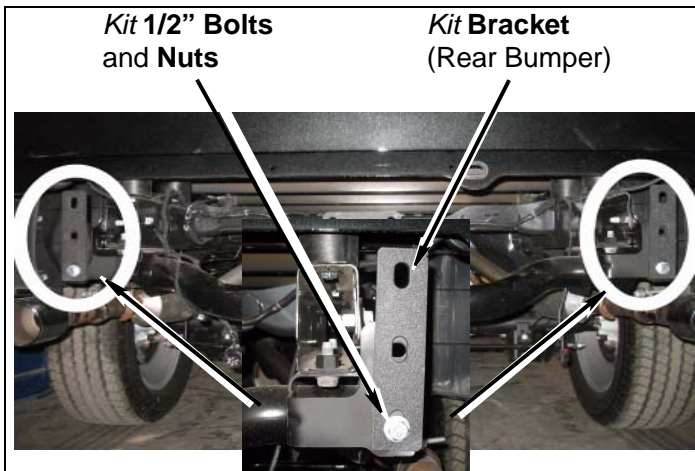

- d. Measure, Mark & Cut rear bumper center section to clearance *kit* bumper (center) bracket.

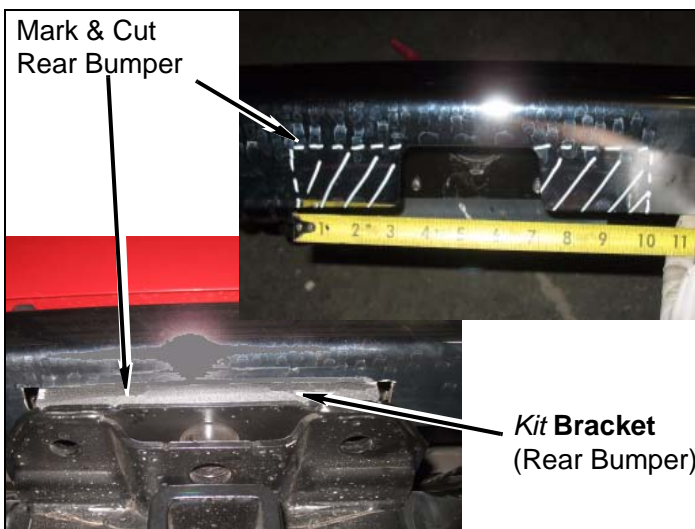

- e. Apply small amount of *kit* Loctite® onto threads of two *kit* bolts (7/16" x 1-1/2") and install rear bumper onto *kit* bracket (rear bumper, middle) with two *kit* bolts (7/16" x 1-1/2"), four *kit* washers (7/16" USS), and two *kit* nuts (7/16" Nylock). DO NOT TIGHTEN.

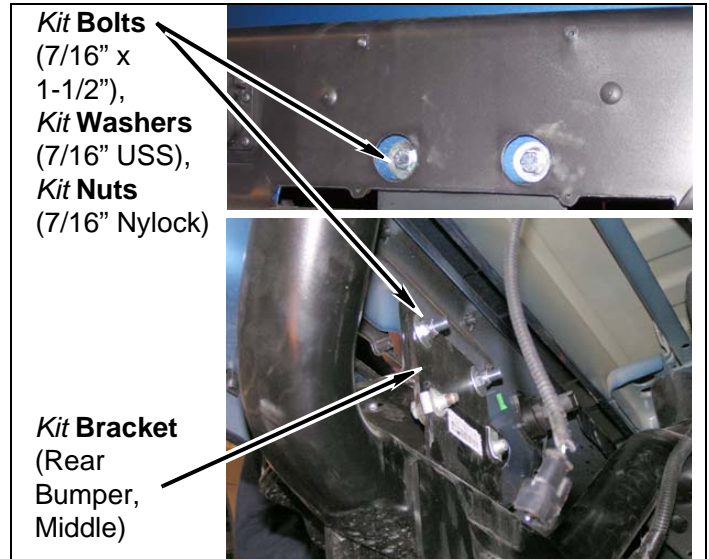

- f. Align rear bumper to previous bed-to-bumper measurements. TIGHTEN all hardware.
- g. Connect wiring harnesses onto bumper.
- h. Install license plate onto rear bumper with two factory screws.

Underside of Vehicle

1. Crush blocks

⚠ WARNING

A certified welder should perform all welding.

- a. Weld two *kit* blocks (3" crush) onto passenger side frame, below bed, where shown.

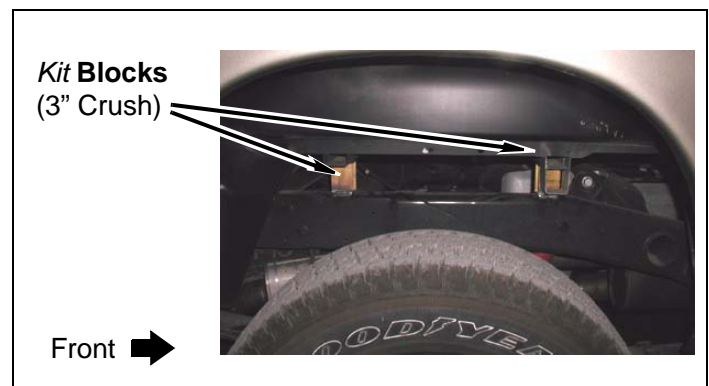

b. Repeat above step for driver side.

⚠ WARNING

Use extreme caution when working near the fuel lines and the fuel tank. Clean up spilled fuel immediately. A spark could cause an explosion or fire resulting in serious personal injury and property damage.

2. Fuel filler

a. Remove two hose clamps and fuel filler assembly from fuel tank.

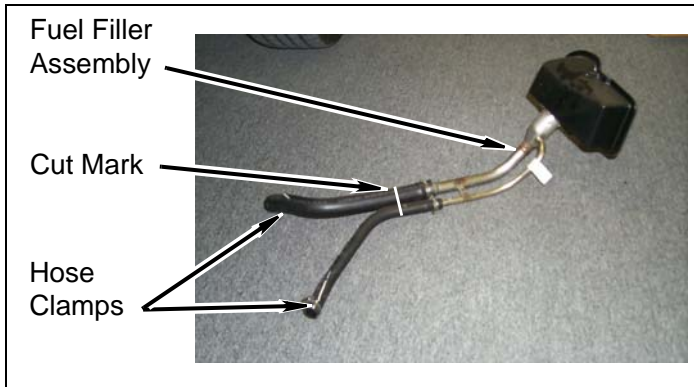

b. Carefully cut vent and fuel hose 2" from end of metal tubes.

c. Install *kit extension* (1-1/2" x 5" long) between cut ends of fuel hose with two *kit clamps* (#28 hose). DO NOT TIGHTEN.

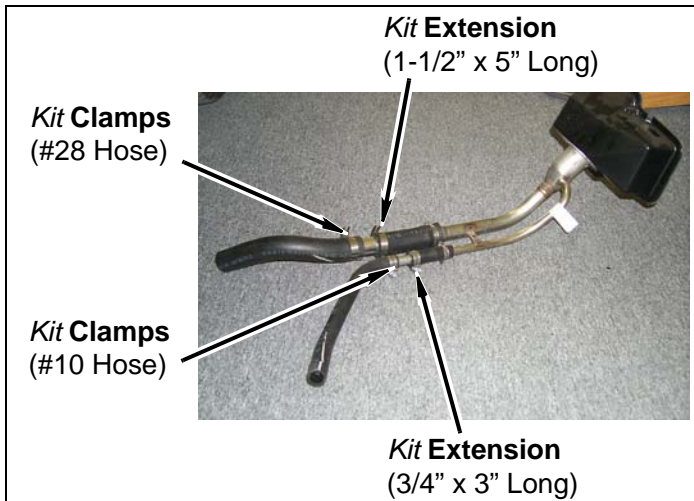

d. Install *kit extension* (3/4" x 3" long) between cut ends of vent hose with two *kit clamps* (#10 hose). DO NOT TIGHTEN.

e. Install fuel filler assembly onto fuel tank with two hose clamps.

f. Install fuel filler assembly onto bed with three factory bolts. Install fuel cap. Adjust fuel filler and TIGHTEN all hose clamps.

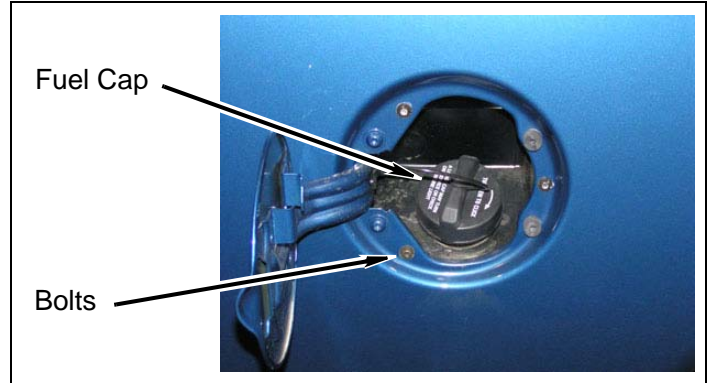

3. Manual transfer case shift linkage

a. Loosen bolt and move trunnion along shift rod to align with 4WD shift lever. DO NOT move 4WD shift lever. TIGHTEN bolt.

b. Install trunnion in 4WD shift lever.

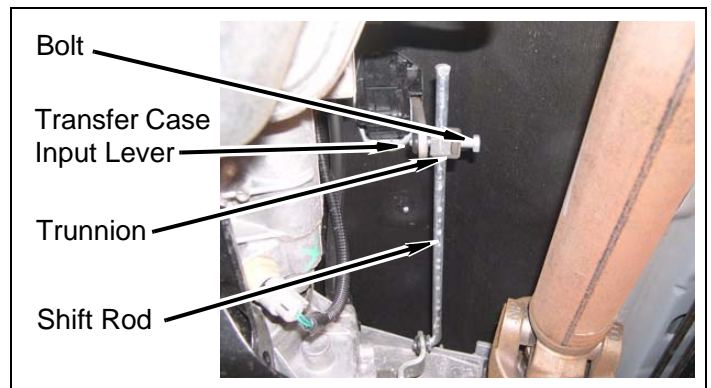

c. Verify the 4WD shift lever operation. Ensure there is complete engagement in all ranges. It may be necessary to adjust the position of the trunnion on the shift rod to obtain proper engagement in all ranges.

4. **2006 Models:** Parking brake cable

a. Install front parking brake cable onto parking brake mount.

b. Pull slack into rear parking brake cable and retain slack with locking pliers. Connect front parking brake cable to rear parking brake cable with junction.

c. Release locking pliers.

5. Ground strap

- a. Install **kit bracket** (studded) to frame on driver side with factory bolt.

Some slight bending of the brake lines is required to align brackets with holes in frame rail. Use caution when bending brake line.

9. Carefully bend brake lines and install brake line bracket and two bolts onto driver side.

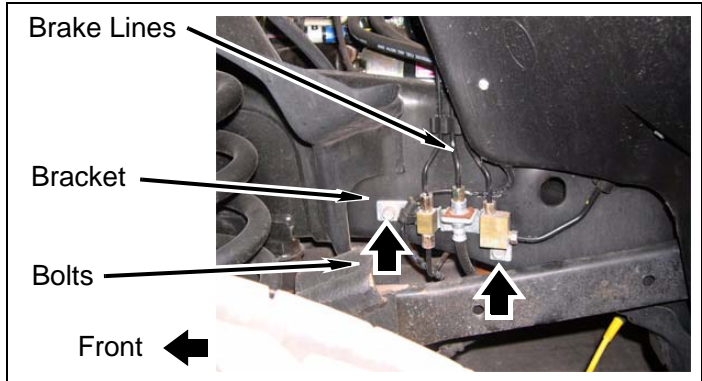
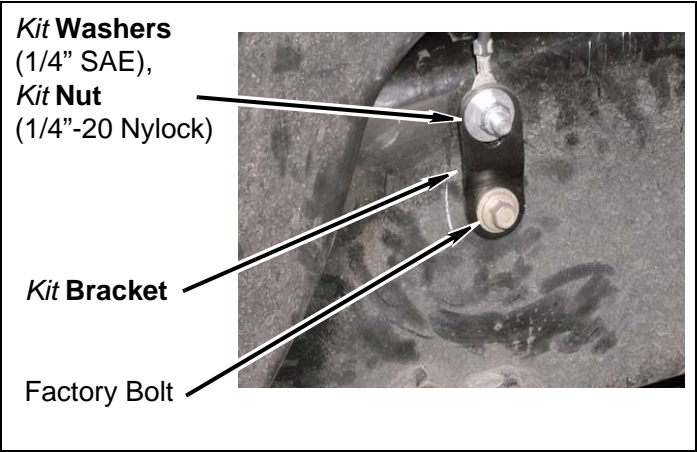

- b. Install ground strap to **kit bracket** (Studded) with two **kit washers** (1/4"-20 x 1") and **kit nut** (1/4"-20 Nylock).

Inside of Vehicle

6. Install ground strap onto lower driver side firewall with nut.

⚠ WARNING
DO NOT DAMAGE any of the parts attached to the shift levers during cutting and/or welding. Damage to the shift lever equipment could result in serious injury or property damage.

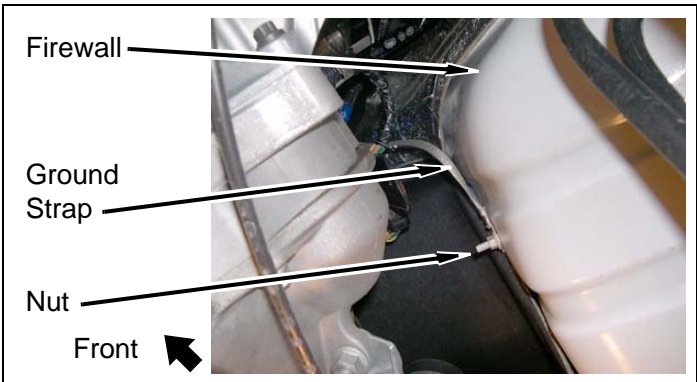

⚠ WARNING
A certified welder should perform all welding.

7. Install automatic transmission shifter cable onto clip with **kit tie** (zip).

1. **Some Models:** Manual transmission and transfer case shift levers

8. Install wire harness and clip onto driver side body mount bracket.

- a. Remove two plastic shift tabs, plastic ball, shim and mounting plate from shift lever.

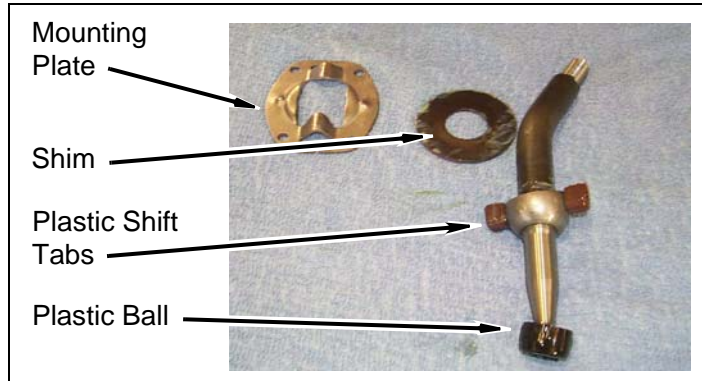
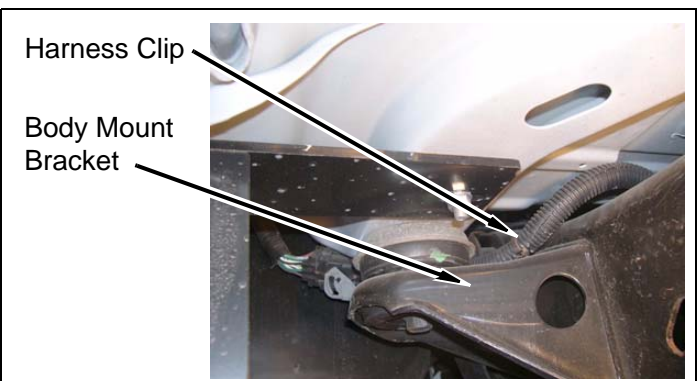

⚠ CAUTION

- b. Scribe a line along side of transmission shift lever (below lowest bend). Measure diameter of shift lever (below lowest bend). Cut lever into two pieces and deburr as necessary.

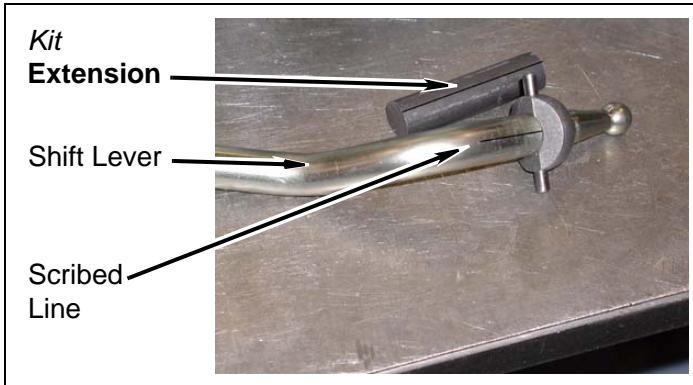

- e. Install two plastic shift tabs, plastic ball, shim, and mounting plate onto shift lever.

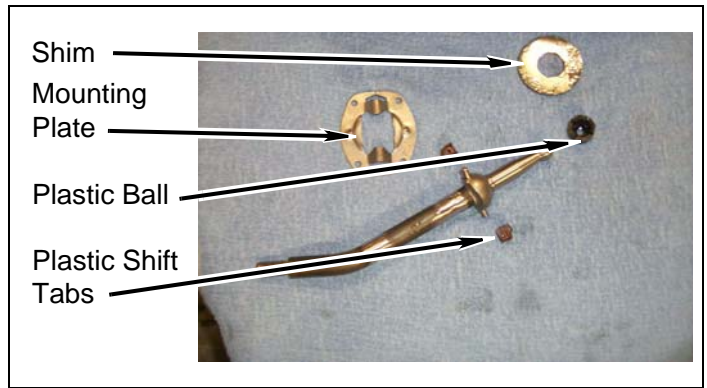

- f. Install shift lever onto shift tower with four Torx bolts.

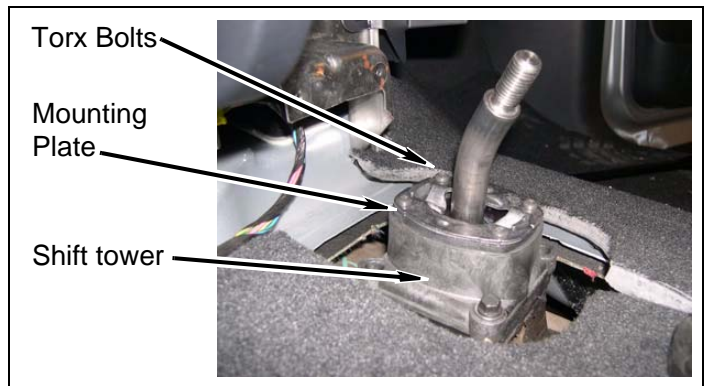

NOTE

If shift lever diameter is 5/8", use *kit extension* (shifter, 5/8" x 3"). If shift lever diameter is 3/4" or larger, use *kit extension* (shifter, 3/4" x 3").

- c. Scribe a line along side of *kit extension*. Position *kit extension* between two pieces of transmission shift lever. Ensure scribed lines on *kit extension* and transmission shift lever align. Weld *kit extension* in place.

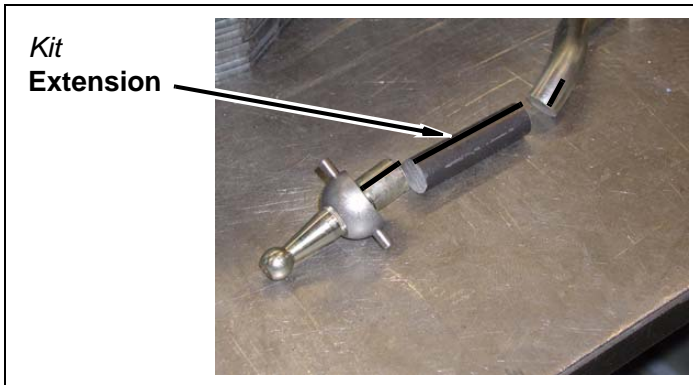

- g. Install rubber cover onto shift tower.

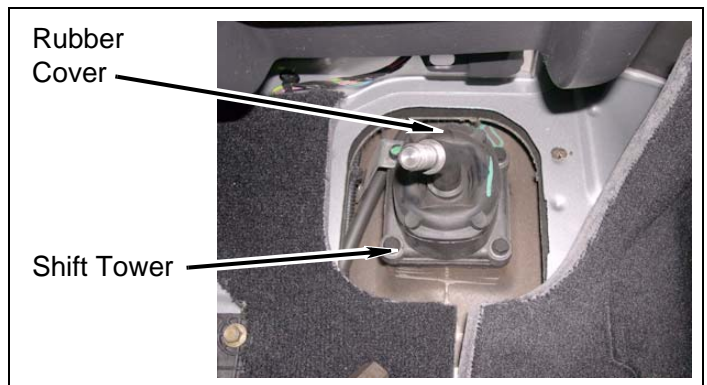

- d. Grind welded surfaces smooth in order to install mounting plate and shim to shift lever.

- h. Install shift lever boot seal onto floor with six bolts.

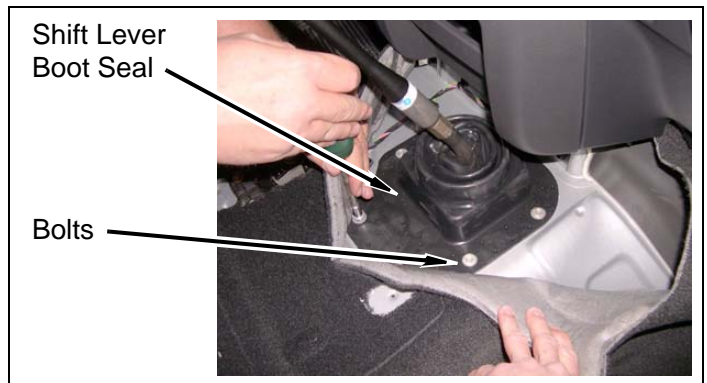
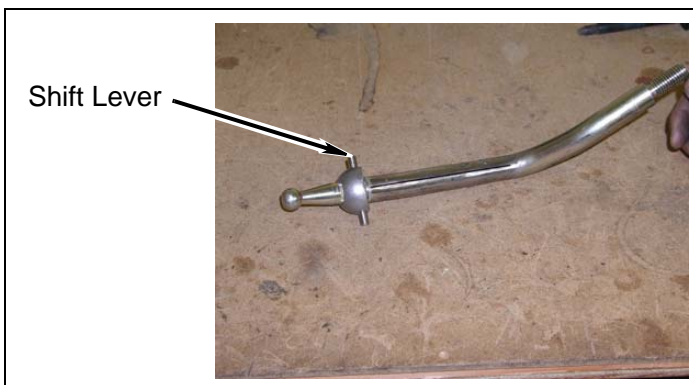

- i. Install center console onto floor with three screws.

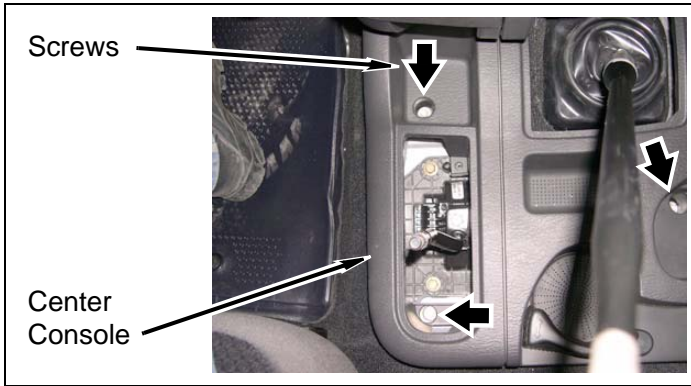

- j. Screw transmission shift lever onto shift tower lever.
- k. Install transfer case shift lever boot onto center console.
- l. Install rubber cup holder inserts onto center console.
- m. Install two shift knobs, two nuts, and two caps onto transmission and transfer case shift levers.
- n. Check transmission and transfer case shift lever operation. Ensure complete engagement in all gears.

2. **Current Models:** Manual transmission shift lever

NOTE
 Installing manual transmission shift lever requires **Kit# SE 9627** available separately.

- a. Install **kit extension** (shifter) onto shift tower with two **kit bolts** (8mm x 30mm), four **kit washers** (8mm), and two **kit nuts** (8mm Nylock).

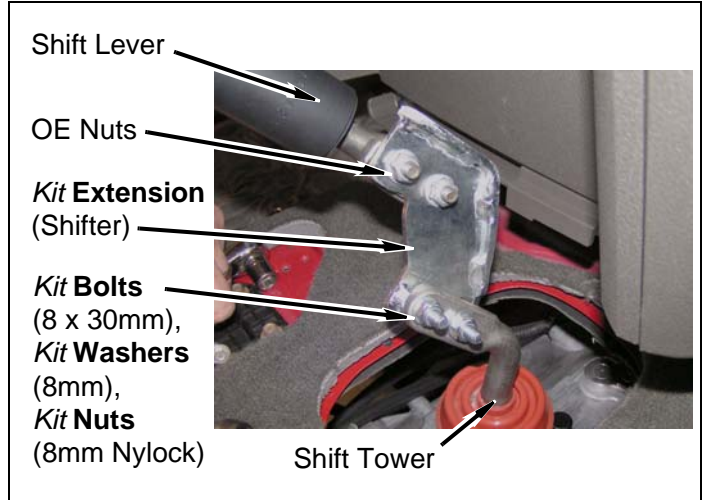

- b. Install manual transmission shift lever onto **kit extension** (shifter) with two OE nuts.
- c. Install shift lever boot seal onto shift lever and floor with six bolts.

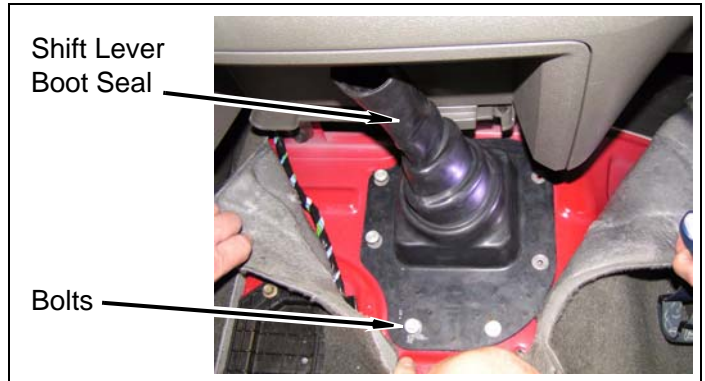

d. Trim manual transmission shift lever boot as shown.

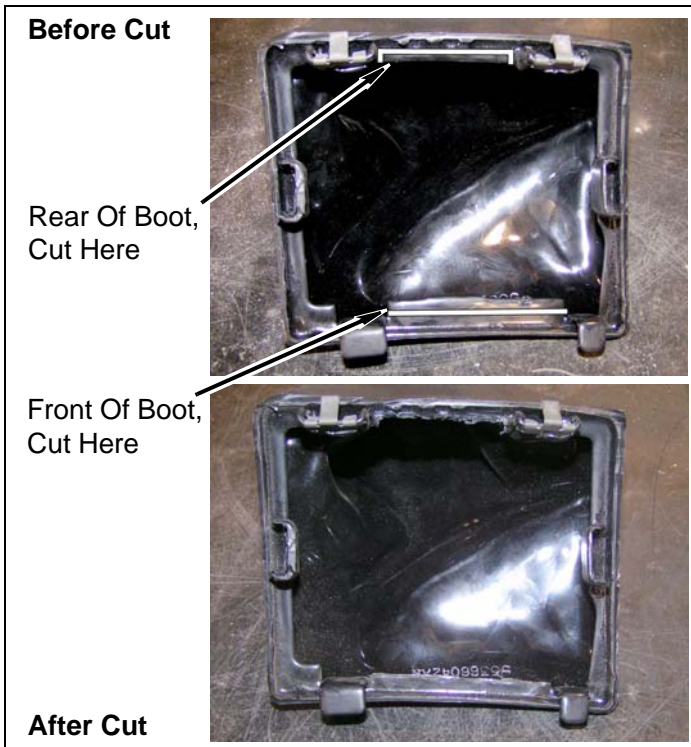

e. Trim shifter console as shown.

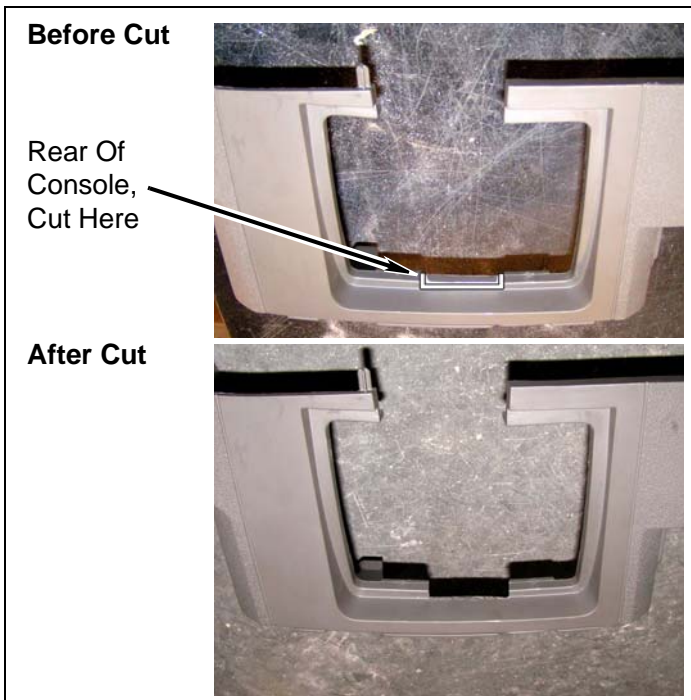

f. Install shifter console onto floor with two screws.

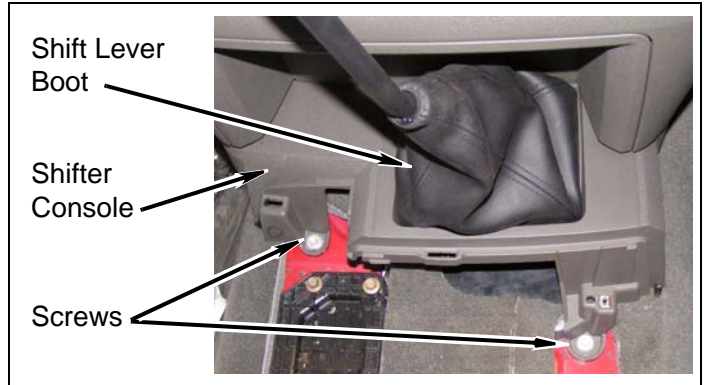

g. Install manual transmission shift lever boot onto shifter console.

h. Install center console onto floor with three screws.

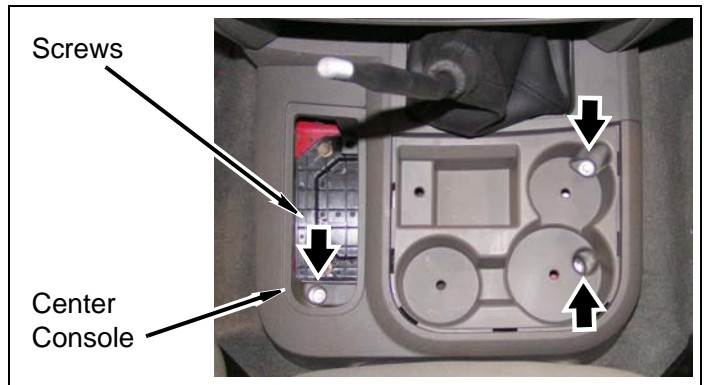

i. Install transfer case shift lever boot onto center console.

j. Install rubber cup holder inserts onto center console.

k. Install two shift knobs, two nuts, and two caps onto transmission and transfer case shift levers.

l. Check transmission and transfer case shift lever operation. Ensure complete engagement in all gears.

Engine Compartment

1. Steering shaft



⚠ WARNING

Verify the steering extension is securely installed as specified in the instructions. Failure to do so may cause steering malfunction, resulting in property damage or serious personal injury.

- a. Install **kit extension** (steering) into lower steering shaft. Ensure marks on upper and lower steering shaft are aligned.

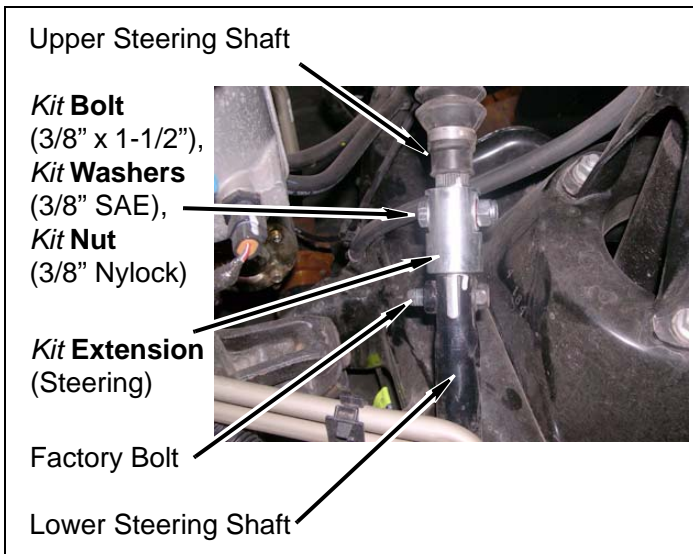

- b. Install upper steering shaft into **kit extension** (steering), ensuring marks on upper and lower steering shaft are aligned.
- c. Apply small amount of **kit Loctite®** onto threads of factory bolt and **kit bolt** (3/8" x 1-1/2").
- d. Install factory bolts into lower steering shaft and **kit extension** (steering) and TIGHTEN to 33 lb.-ft.

- e. Install **kit bolt** (3/8" x 1-1/2"), two **kit washers** (3/8" SAE), and **kit nut** (3/8" Nylock) into upper steering shaft and **kit extension** (steering) and TIGHTEN to 33 lb.-ft.

2. Install wiring harness onto rear engine lift hook with **kit tie** (zip).

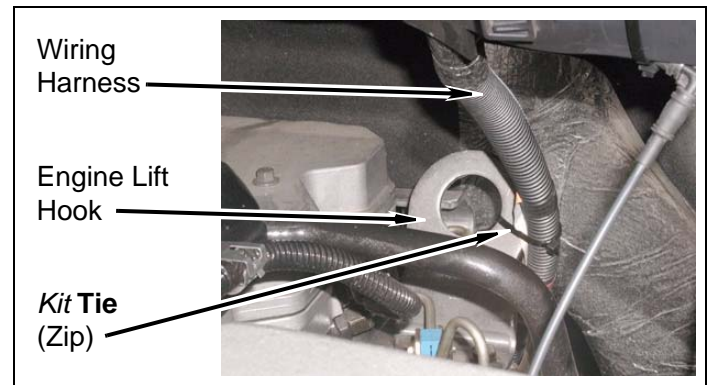

3. Install two push clips and block heater cord onto passenger side frame.

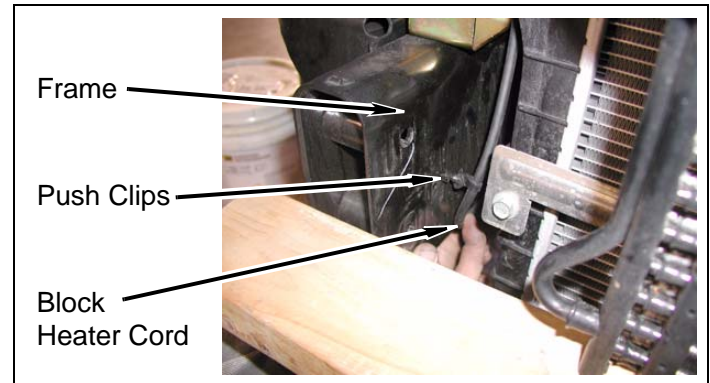

4. Passenger side negative battery cable

- a. Remove bolt and negative battery cable from passenger side of engine block.

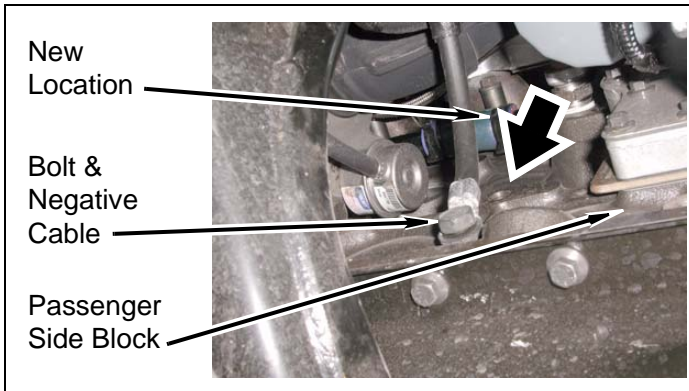

- b. Install bolt and negative battery cable into location approximately 2" above previous location on passenger side of engine.

- c. Install two wire connectors onto **kit bracket** (positive cable) with **kit bolt** (1/4" x 3/4"), two **kit washers** (1/4" SAE), and **kit nut** (1/4" Nylock). DO NOT connect battery cables to battery at this time.

5. Driver side negative battery cable

- a. Remove bolt and negative battery cable from driver side of engine block.

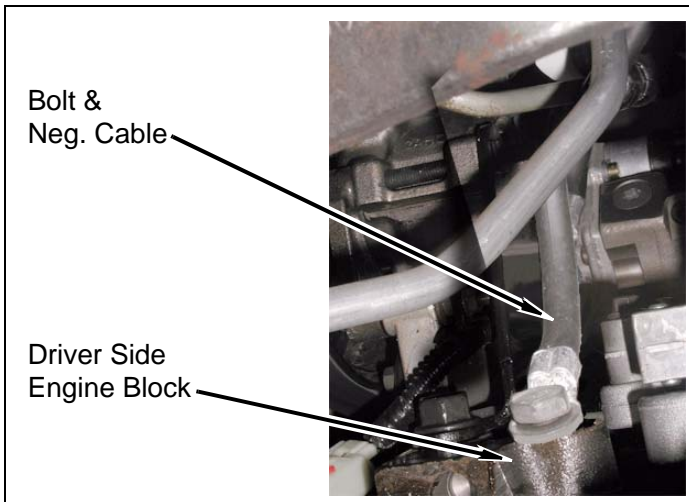

- b. Install **kit bracket** (angled) onto engine with bolt. DO NOT TIGHTEN.

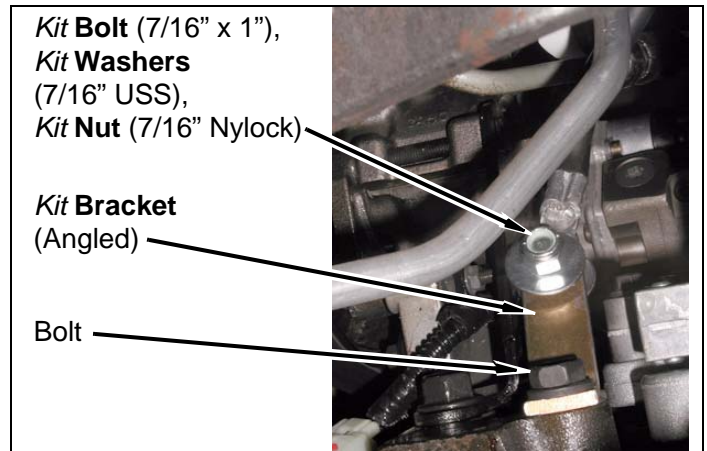

- c. Install negative battery cable onto **kit bracket** (angled) with **kit bolt** (7/16" x 1"), two **kit washers** (7/16" USS), and **kit nut** (7/16" Nylock). TIGHTEN all hardware.

6. Airbox

- a. Remove stud and bolt from passenger side core support.

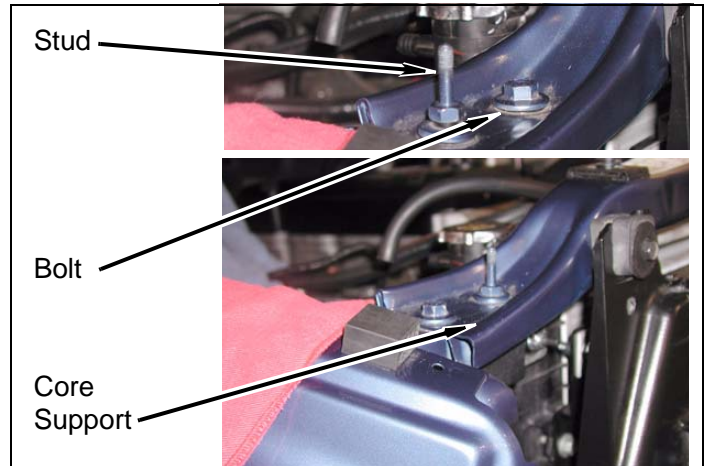

- b. Install stud and bolt into passenger side core support in opposite locations.

- c. Remove two rubber grommets from passenger side battery box support tabs.

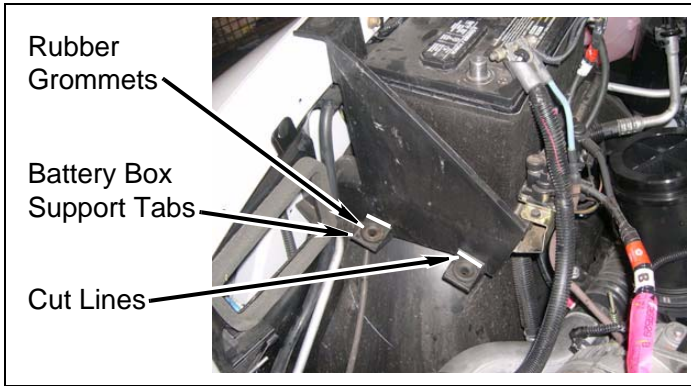

- d. Mark two cut lines on battery box support tabs. Cut support tabs from battery box along lines. Where support tabs were cut from battery box, ensure smooth surface. Grind or sand, if necessary.

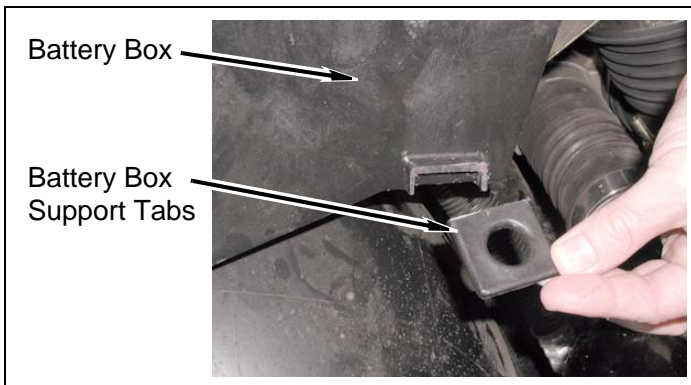

NOTE
The following procedure allows additional visibility for installing **kit brackets** (airbox).

- e. Remove eight screws and passenger side wheel well from vehicle.

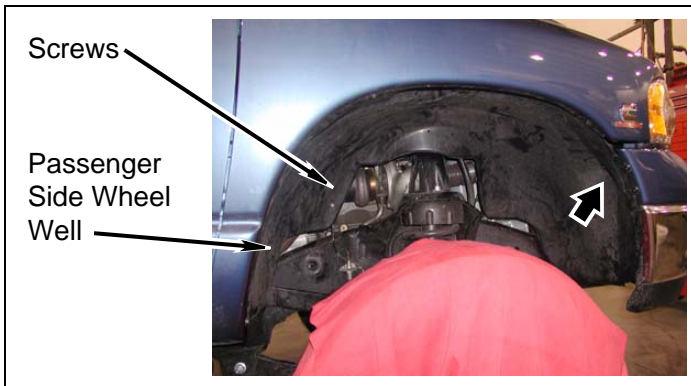

- f. Cut template from back cover of these instructions. Position template on backside of passenger side battery box with tape. Mark hole locations.

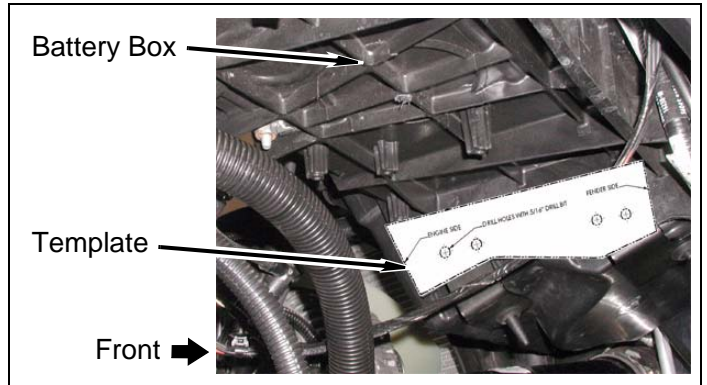

- g. Drill four 5/16" holes in marked locations.
- h. Install **kit bracket** (airbox, driver) onto battery box with two **kit bolts** (1/4" x 1"), four **kit washers** (1/4" SAE), and two **kit nuts** (1/4" Nylock).

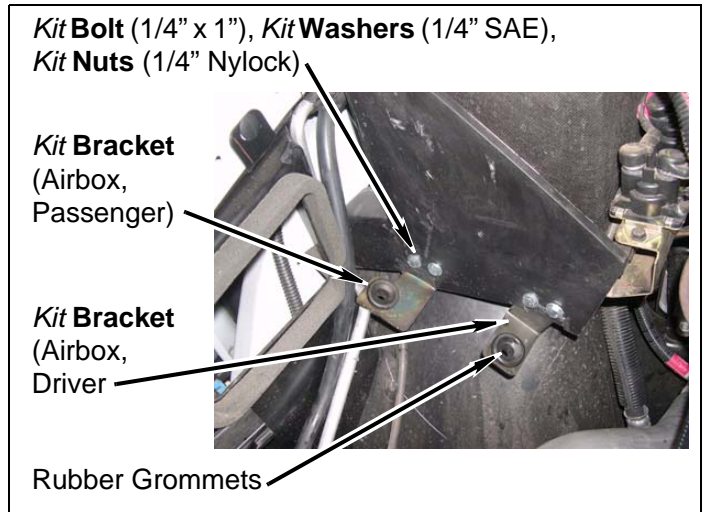

- i. Repeat above step for **kit bracket** (airbox, passenger).
- j. Install two rubber grommets into two **kit brackets** (airbox).
- k. Remove all clips holding wires leading to solenoid. (**Note:** Damage to wires may occur if this step is not followed.)

- l. Gently bend the solenoid bracket down from 90 degrees to approximately 175 degrees or until intake hose clears the solenoid pack when intake hose is reinstalled.

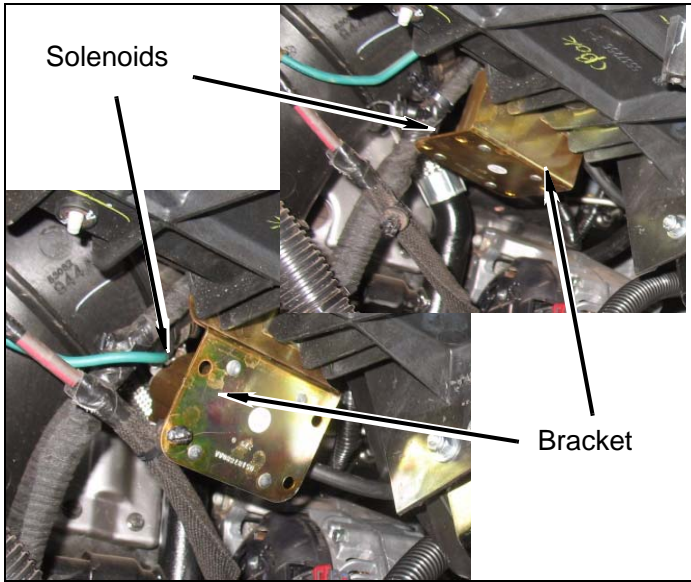

- m. Install wiring harness push clip onto battery tray.

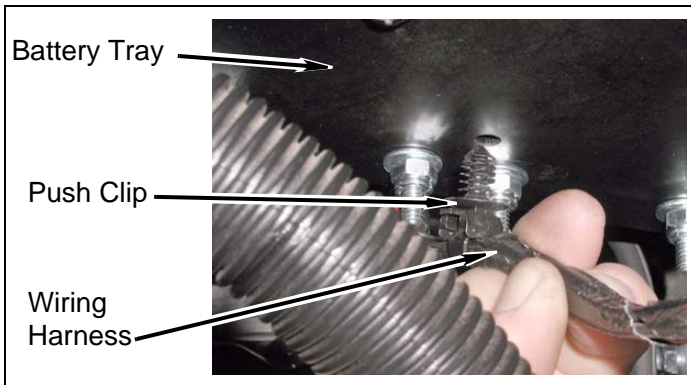

- n. Install **kit bolt** (1/4" x 1") and **kit washer** (1/4" SAE) onto **kit bracket** (airbox mount). Install **kit bracket** (airbox mount) onto stud with nut. DO NOT TIGHTEN.

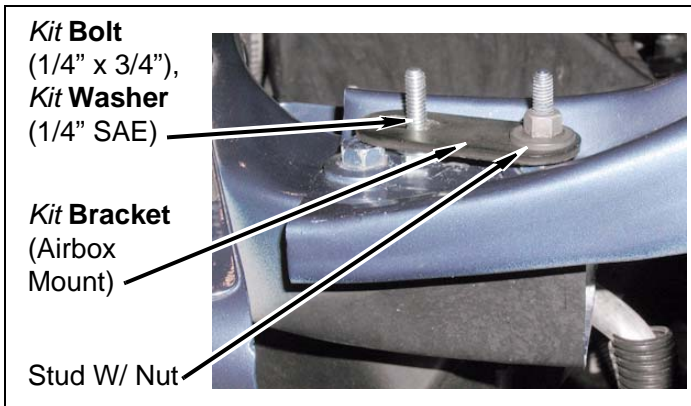

- o. Install airbox onto **kit brackets** (airbox) and **kit bracket** (airbox mount) with **kit bolt** (1/4" x 3/4"), two **kit washers** (1/4" SAE), and **kit nut** (1/4" Nylock). TIGHTEN all hardware.

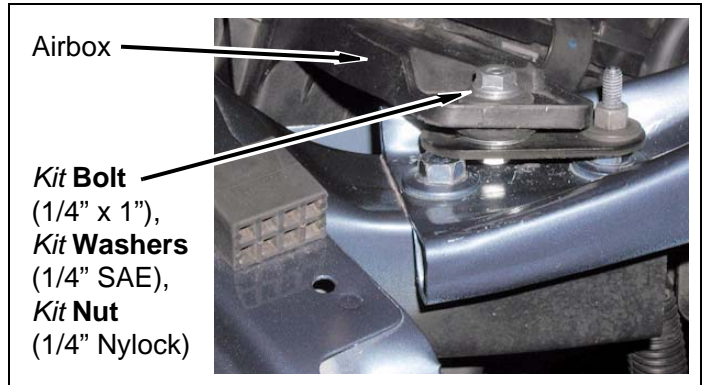

- p. Install air filter, airbox cover, and three clips onto airbox.

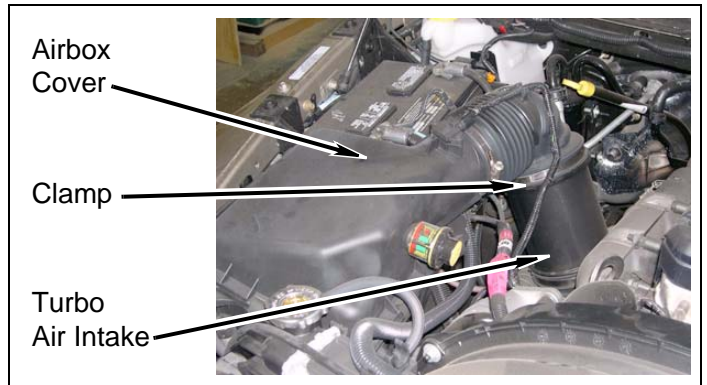

- q. Install airbox hose onto turbo air intake with clamp.

- r. Install radiator overflow hose onto radiator.

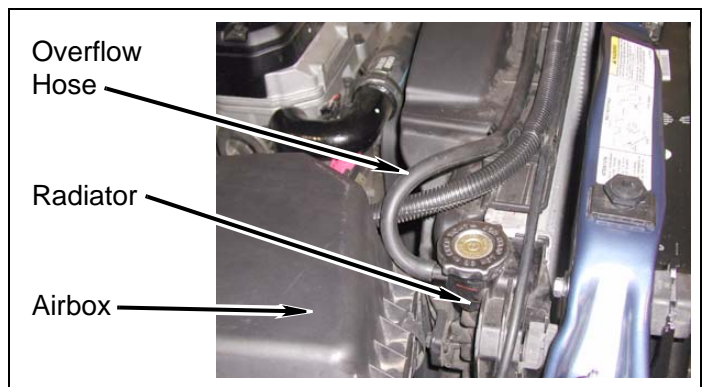

- s. Install passenger side wheel well onto vehicle with eight screws.

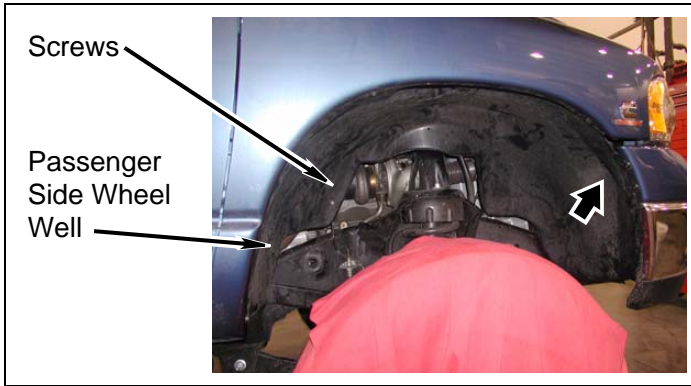

- t. Install brake sensor wiring harness push clips onto passenger and driver side wheel wells.

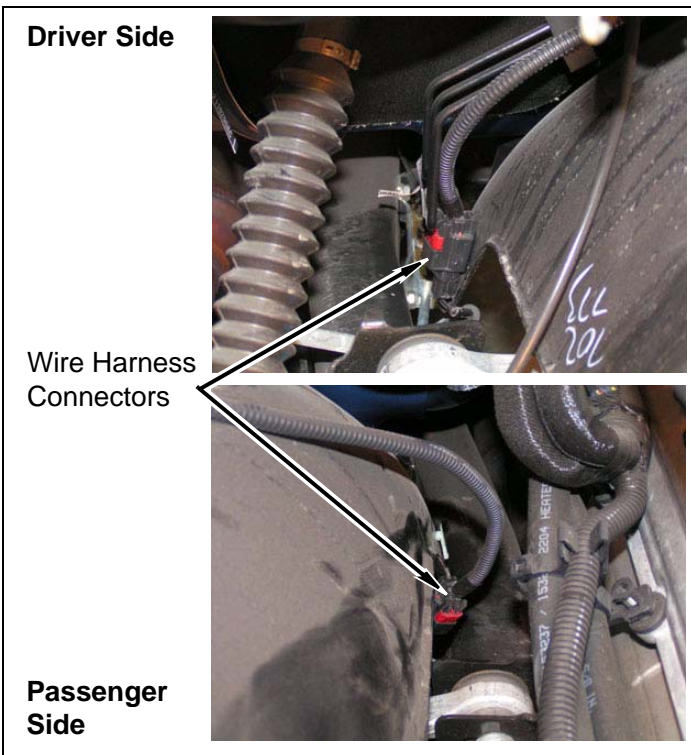

Front of Vehicle

1. Radiator Installation

- a. Remove engine fan and clutch harness from fan shroud.
- b. Measure, mark and cut center of fan shroud. Locate edge of upper fan shroud mount and measure approximately **4.75"** down towards center of fan shroud. This measurement should locate you near the center of the fan shroud for the proper trim cut on both sides of the fan shroud.
- c. Once you have measured and marked your trim cuts, use a cutting tool to cut the fan shroud in half for next step.

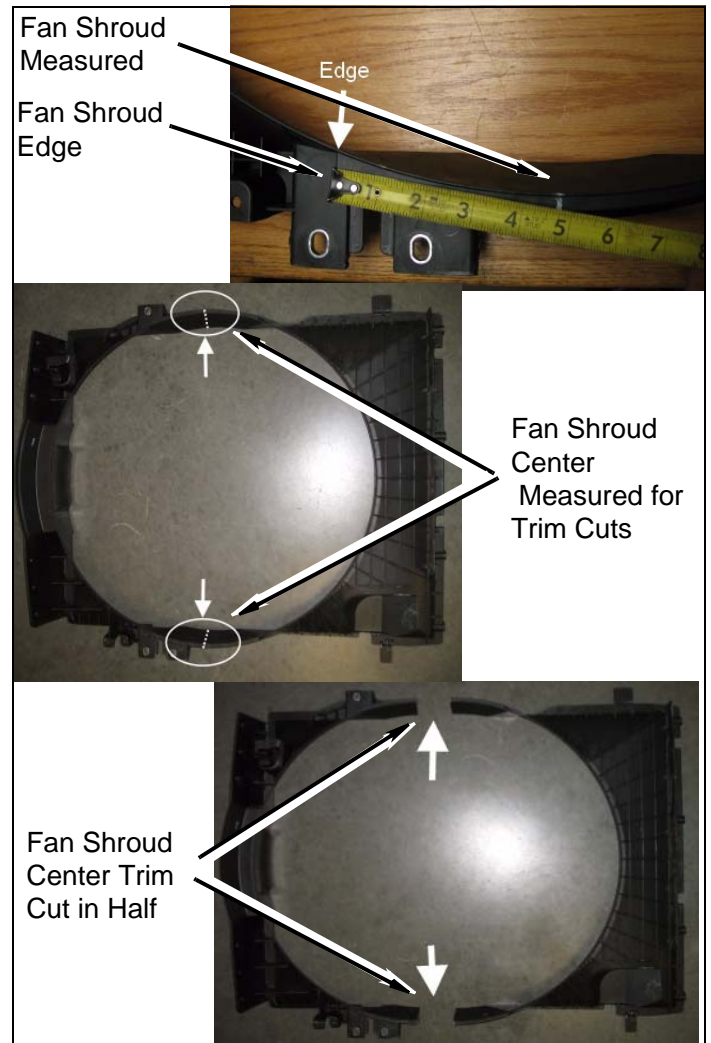

- d. Separate both halves of the fan shroud on a flat and level surface. (**Note:** Allow for lower edge of fan shroud to over hang your flat surface; this will allow the shroud to sit level on a table or work bench.)

- e. Separate fan shroud so that each side is equally "gapped" to 3" ; extending the over all length of the fan shroud by 3".

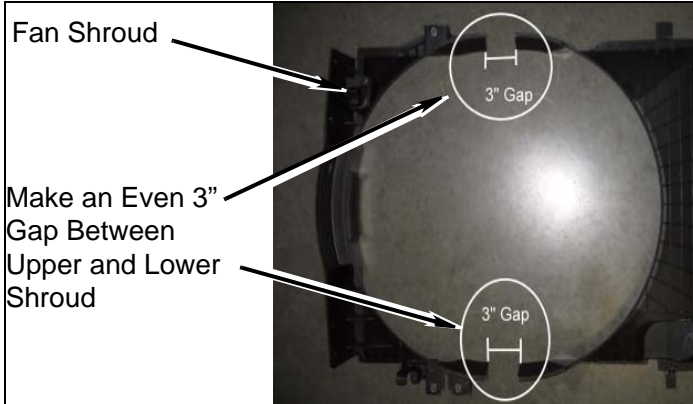

- f. Locate both *kit inside*(short) & **outside**(long) **center fan shroud** brackets.
- g. Using *kit inside*(short) & **outside**(long) **center fan shroud** brackets as templates; shape them properly into place along side the fan shroud and allow them to contour against the shroud.
- h. Once you have shaped and placed each fan shroud bracket into place; clamp and secure each *kit shroud bracket*, then mark the proper 1/4" holes for drilling.

Note: Leaving brackets in place, while drilling, will ensure that you drill through the proper locations while drilling all seven "through holes" during this process.

- i. Once you have drill each hole use four *kit* (1/4"x1 1/4") to fasten the center insides bracket and three *kit* (1/4"x1 1/2") to fasten the center outsides of each bracket.

Note: Do not attempt to over tighten kit hardware against fan shroud, damage will occur to shroud.

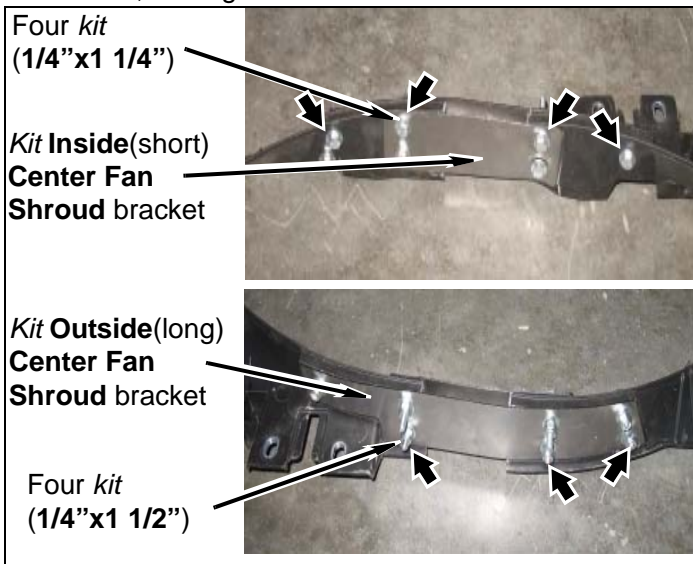

Note: Be sure to install all *kit* (1/4") hardware from inside to outside of kit fan shroud brackets. Doing so will eliminate the chance of kit hardware contacting the engine fan after shroud is reinstalled into vehicle.

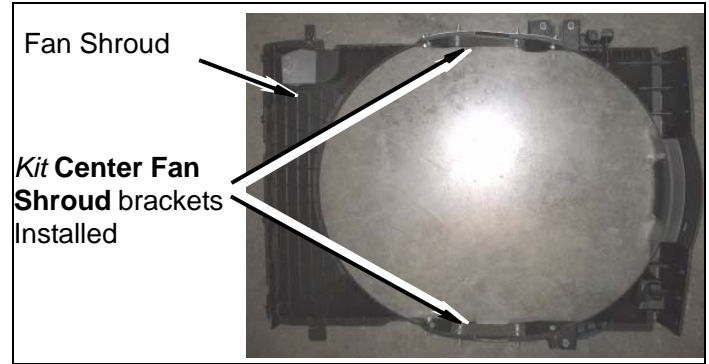

- j. Carefully reinstall engine fan & fan shroud back into lower locking tabs and engine fan clutch back onto engine water pump pulley with correct tooling.

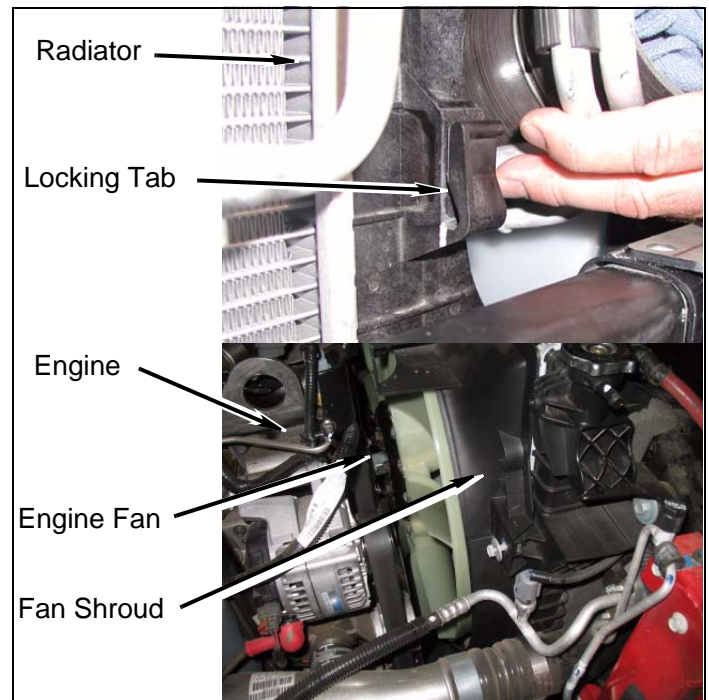

- k. Using OEM hardware; secure fan shroud to radiator.

- l. Locate both *kit lower fan shroud* brackets. Assemble with one *kit bolt*(1/4"x3/4"), washers & nut.

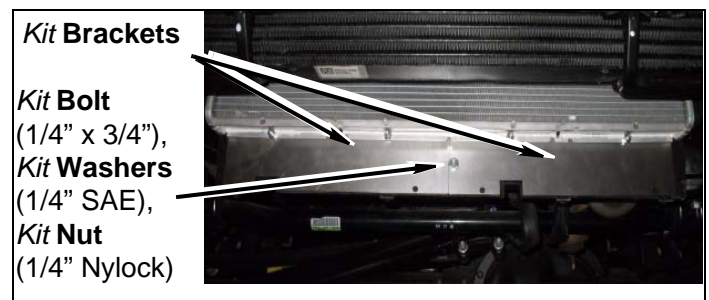

- m. Install both **kit lower fan shroud brackets** into lower radiator pocket. Attach kit brackets with four **kit bolts**(1/4"x3/4"), **washers & nuts** onto back side of lower radiator.

- b. Install transmission cooler onto two **kit brackets** (cooler) with two **kit bolts** (1/4" x 3/4"), four **kit washers** (1/4" SAE), and two **kit nuts** (1/4" Nylock).

Note: Be sure **kit bolts** are installed from the engine side facing forward, with the kit nuts visible.

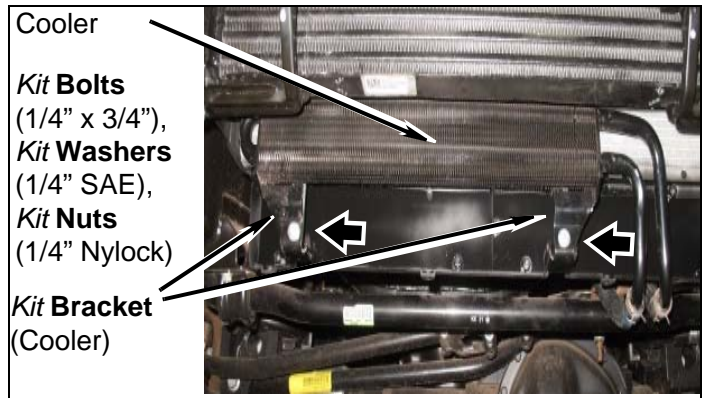
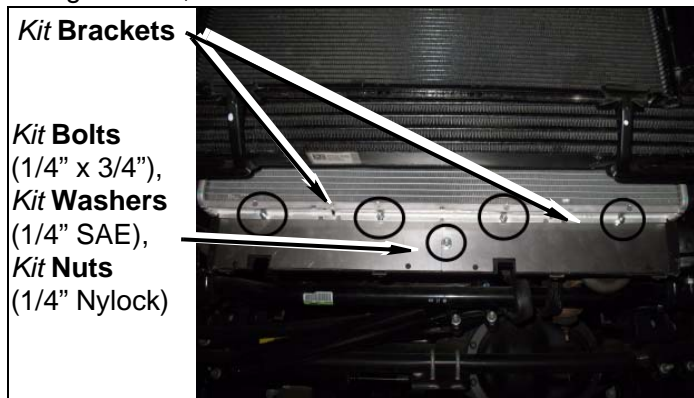

- n. Mark & drill four holes through **kit lower fan shroud brackets** and lower fan shroud.
- o. Secure **kit lower fan shroud brackets** with four **kit bolts**(1/4"x3/4"), **washers & nuts** onto inside of lower radiator shroud.

3. Intercooler

- a. Position intercooler onto core support. Ensure rubber isolators are positioned between intercooler and core support.

Note: Be sure **kit bolts** are installed from the engine side facing forward, with the kit nuts visible.

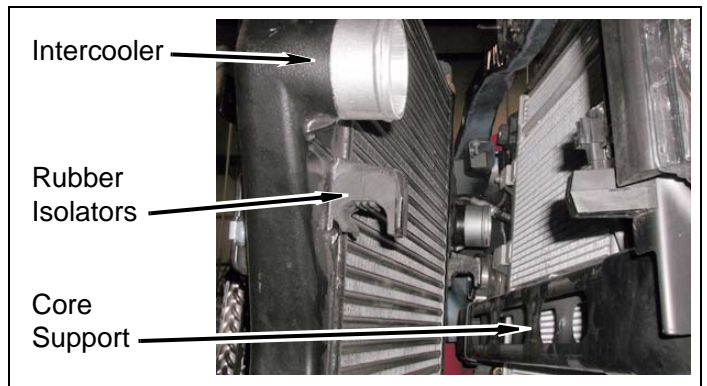
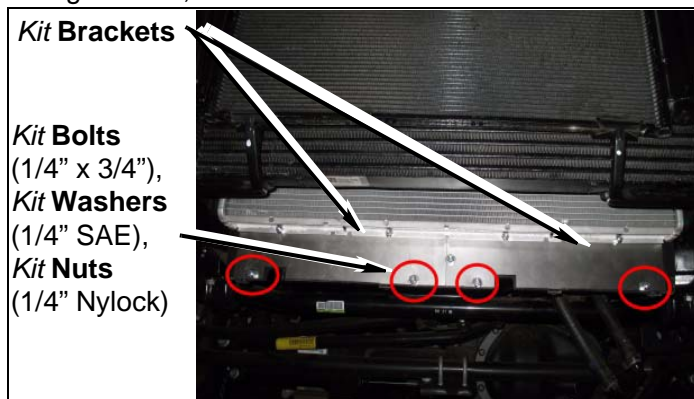

- b. Reinstall intercooler piping onto intercooler.
- c. Adjust & tighten all eight intercooler hose clamps on intercooler, piping and engine.

2. Transmission cooler models

- a. Install two **kit transmission cooler drop brackets** with two **kit bolts**(1/4"x3/4"), **washers & nuts** onto front side of lower radiator..

Note: Be sure that none of the couplers are binding.

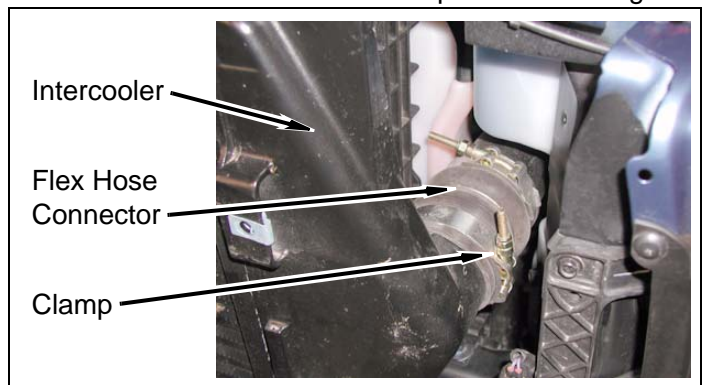
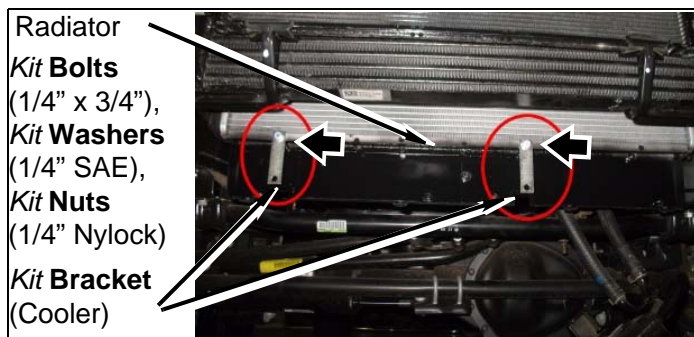

- d. Install intercooler onto upper core support with two bolts..

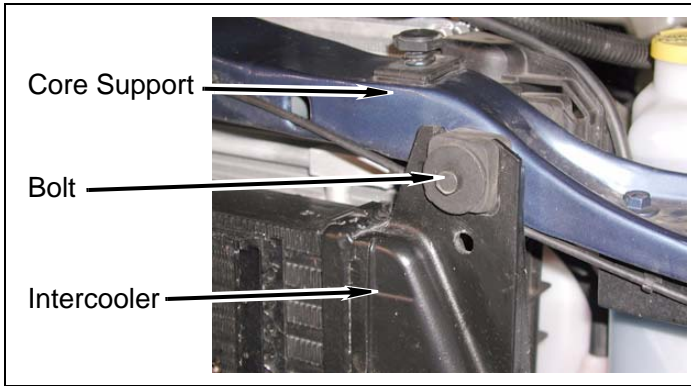

NOTE
Slight bending of the AC lines may be required. Use care when bending AC lines as to avoid pinching or cracking.

4. Front bumper

- a. Mark and trim two front bumper brackets as shown. Test fit front bumper onto vehicle.

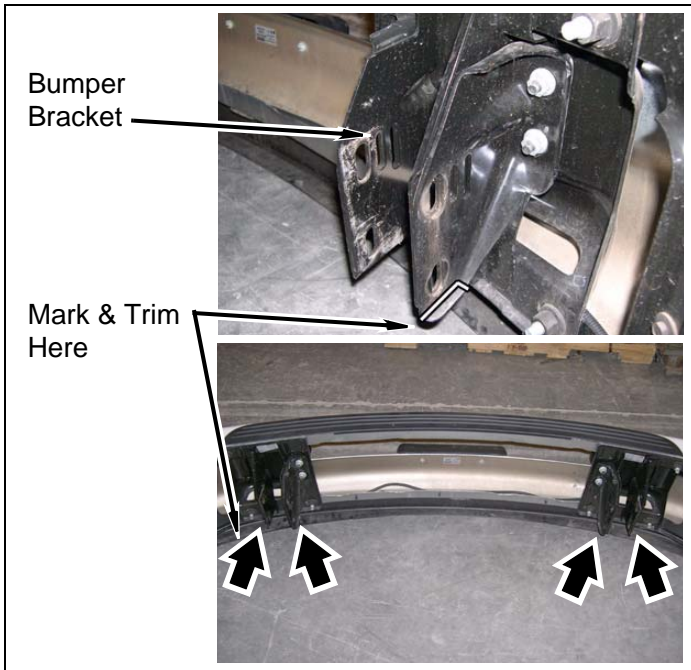

- b. Apply small amount of *kit* Loctite® onto threads of factory front bumper bolts.

- c. Install two *kit* brackets (front bumper) and *kit* spacer (2-1/4" long) onto driver side front bumper bracket with *kit* bolt (12mm x 100mm), two *kit* washers (7/16" USS), and *kit* nut (12mm Nylock). Ensure head of *kit* bolt (12mm x 100mm) is facing towards center of vehicle. DO NOT TIGHTEN.

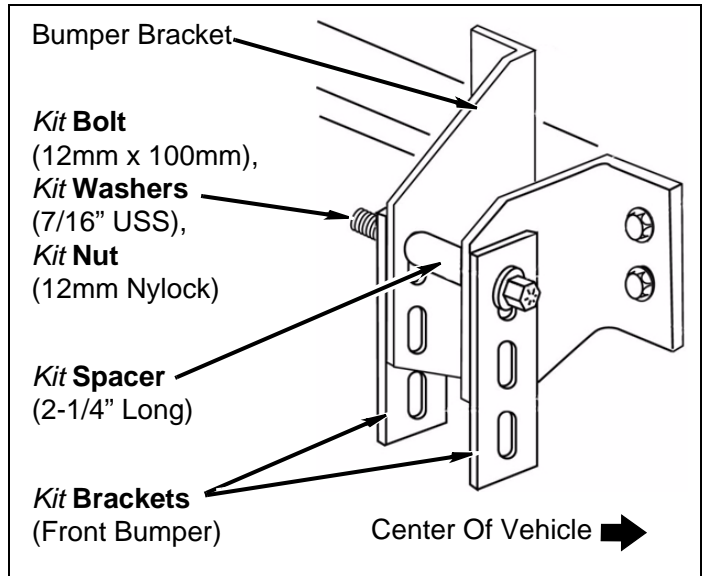

- d. Repeat above step for driver side front bumper bracket.
- e. Position front bumper to frame. Ensure both edges of fender well fit on backside of bumper edge.

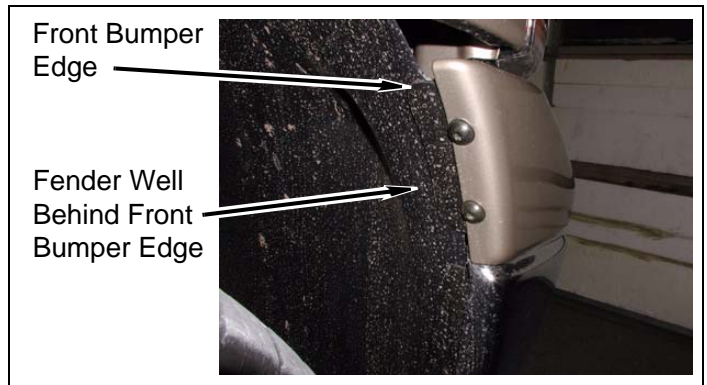

- f. Install front bumper onto frame with four **kit washers** (1/2", thick), two double bolt fasteners and four nuts. Install **kit washers** (1/2", thick) on bottom bolt of double bolt fasteners, between **kit bracket** (front bumper) and frame. Snug hardware, but **DO NOT TIGHTEN**.

- h. Connect fog light harness at driver side of front bumper and install connector onto front bumper, if equipped.

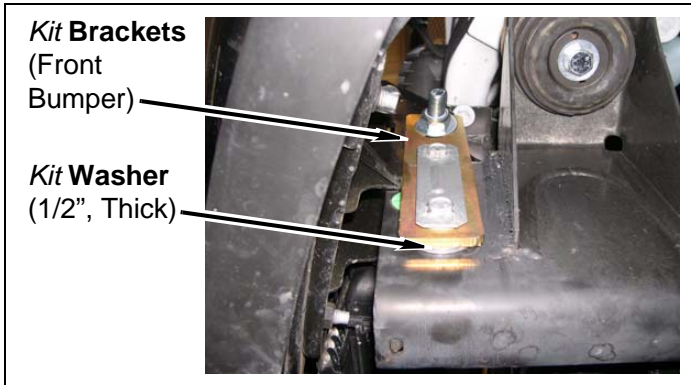
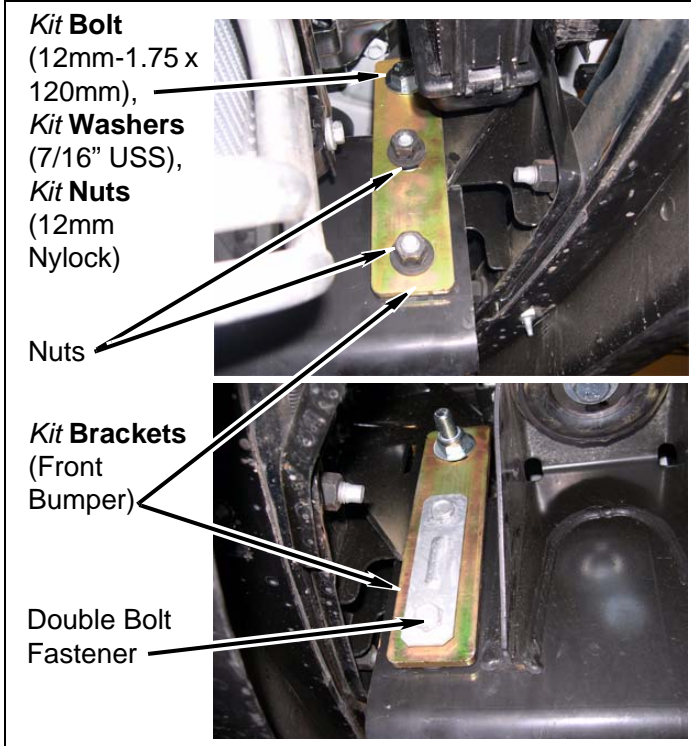

NOTE
It may be necessary to compensate for space between **kit brackets** (front bumper) and frame on bottom bolt of double bolt fastener. Do so with additional **kit washers** (1/2", thick) or **kit washers** (7/16") when required.

- g. Align front bumper-to-cab spacing to previous measurements. **TIGHTEN** all hardware.

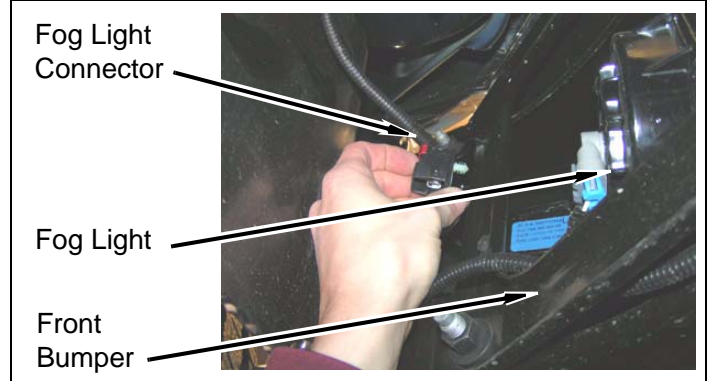

5. Front grill

- a. Reinstall front air shield onto grill and core support using clips.
- b. Reinstall grill into core support and secure grill using four bolts.

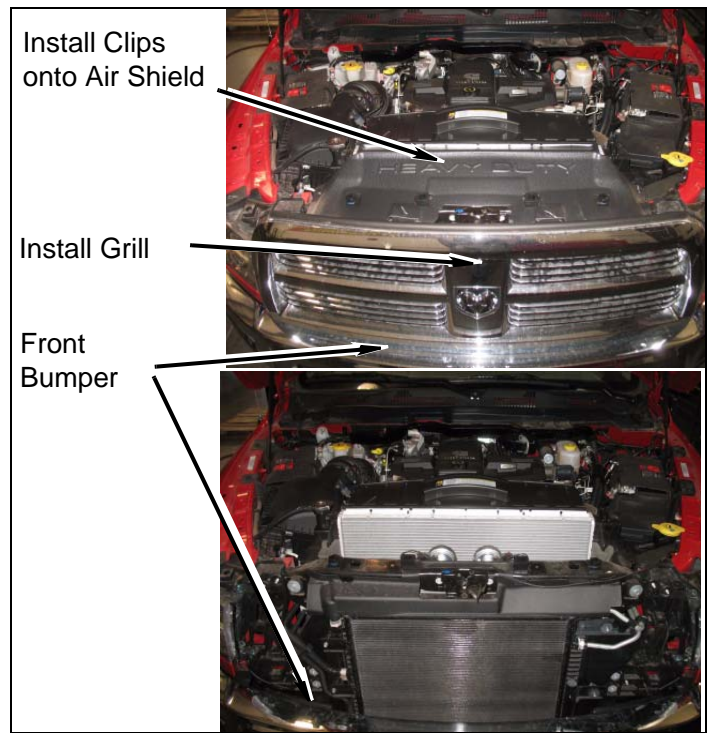

After Completing Installation

Engine Compartment

1. Airbag fuse

NOTE
The location of the airbag fuse may vary; check the owner's manual.

- a. Install airbag fuse(s).

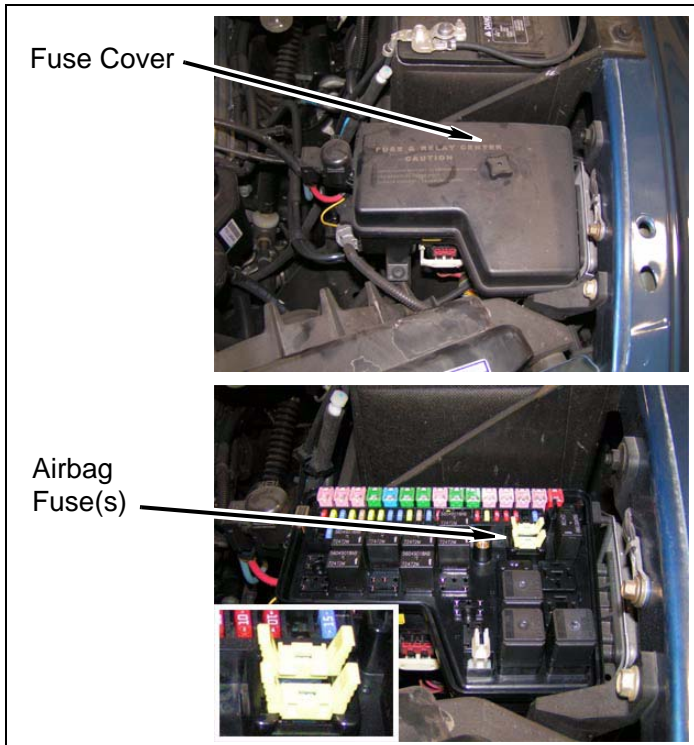

- b. Install fuse cover.

2. Connect both battery cables onto both batteries. Connect positive cables first, then negative cables.

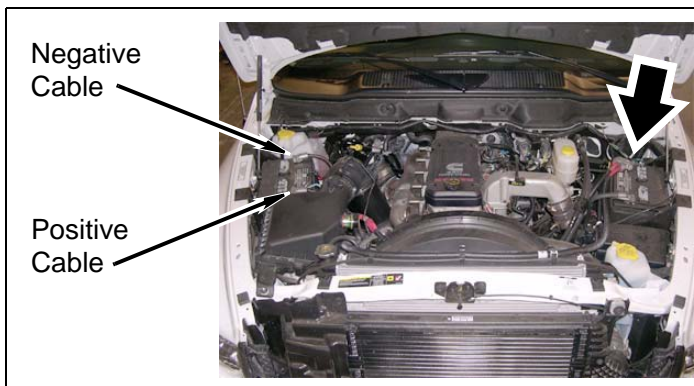

3. If necessary, trim **kit hose** (5/8" x 12").

Miscellaneous

1. Apply **kit label** (warning) to dashboard in plain sight of all vehicle occupants.
2. Check all fasteners to ensure they are tight.
3. Ensure all wires, hoses, cables, etc. are properly connected and there is ample slack.
4. Adjust headlights.

Dynamic Vehicle Check

1. Test-drive vehicle. Check steering in both directions to ensure that there is no bind. Check operation of clutch, brake system, and parking brake. Check operation of transmission and transfer case. Ensure there is full engagement in all gears and 4WD ranges. Check battery connections and electrical component operations.

⚠WARNING

Retorque all fasteners after 500 miles and after off road use. All body lift components should be visually inspected and fasteners retorqued during routine vehicle servicing.

⚠CAUTION

Performance Accessories does not recommend any particular wheel and tire combinations for use with its body lifts and cannot assume responsibility for the customer's choice of wheels and tires. Refer to your owner's manual for recommended tire sizes and warnings related to the use of oversized tires. Larger wheel and tire combinations increase stress and wear on steering and suspension components, which leads to increased maintenance and higher risk for component failure. Larger wheel and tire combinations also alter speedometer calibration, braking effectiveness, center of gravity, and handling characteristics. Consult an experienced local off road shop to find what wheel and tire combinations work best with your vehicle.

NOTE

All warranty information, instruction sheets, and other documents regarding the installation of this product must be retained by the vehicle owner. Information contained in the instructions and on the warranty card will be required for any warranty claims. The vehicle owner needs to understand the modifications made to the vehicle and how they affect vehicle handling and performance. Failure to provide the customer with this information can result in damage to the vehicle and severe personal injury.

Accessories

The following accessories are available:



841 S. 71st Avenue • Phoenix, AZ 85043
(623) 907-0081
www.performanceaccessories.com

Kit # PA6623: Front and Rear Gap Guards



Kit Parts List

Qty. Description

16	Block
4	Block (3" crush)
8	Bolt (12mm-1.50x 100mm)
2	Bolt (12mm-1.75 x 120mm)
8	Bolt (12mm-1.75 x 180mm)
2	Bolt (12mm-1.75 x 220mm)
18	Bolt (1/4" x 3/4")
7	Bolt (1/4" x 1 1/4")
8	Bolt (1/4" x 1 1/2")
1	Bolt (3/8" x 1-1/2")
2	Bolt (5/16" x 1")
1	Bolt (7/16" x 1")
2	Bolt (7/16" x 1-1/2")
2	Bolt (1/2" x 1-1/4")
34	Nut (1/4" Nylock)
2	Nut (12mm Nylock)
1	Nut (3/8" Nylock)
2	Nut (5/16" Nylock)
3	Nut (7/16" Nylock)
2	Nut (1/2" Nylock)
6	Tie (zip)
4	Washer (1/2", thick)
4	Washer (1/2", USS)
62	Washer (1/4" SAE)
2	Washer (3/8" SAE)
4	Washer (5/16" USS)
2	Washer (7/16" SAE)
26	Washer (7/16" USS)
1	Bracket (3" w/ stud)
1	Bracket (airbox mount)
1	Bracket (airbox, driver)
1	Bracket (airbox, passenger)
4	Bracket (front bumper)
2	Bracket (trans cooler drop)
2	Bracket (radiator, inside)
2	Bracket (radiator, outside)
1	Bracket (radiator, driver lower)
1	Bracket (radiator, passenger lower)
2	Bracket (rear bumper, driver/passenger)
1	Bracket (rear bumper, middle)
1	Bracket (spare tire ratchet tube)
1	Bracket (spare tire winch)
1	Bracket (angled, negative cable)
2	Clamp (#10 hose)
2	Clamp (#28 hose)
2	Tube (bumper, spacers)
1	Extension (1-1/2" x 5")
1	Extension (3/4" x 3")
1	Extension (shifter, 5/8" x 3")
1	Extension (shifter, 3/4" x 3")

1	Extension (steering)
1	Instruction sheet
2	Label (logo)
1	Label (warning)
1	Label (warning, rear bumper)
1	Loctite ® (6mL bottle)

NOTE

Depending on the vehicle configuration (automatic or manual transmission, 2WD or 4WD, cab length, bed length, etc.), some parts may not be used.

