



3651 N Highway 89 • Chino Valley, AZ 86323
(928) 636-7080

**FORD F150 2WD, 4WD
(V8 ENGINE & STYLE SIDE
MODELS ONLY)
3" BODY LIFT KIT
INSTALLATION INSTRUCTIONS
2006!&\$\$, KIT #70083**

⚠ WARNING
This kit should only be installed on a vehicle that is in good working condition. Before you install the kit, thoroughly inspect the vehicle for corrosion or deformation of the sheet metal around the factory body mounts. If the vehicle is suspected to have been in a collision or misused, do not install this kit. Off-road use of your vehicle with this kit installed may increase the stress applied to the factory body mounts. We do not recommend that any vehicle with a body lift kit installed be involved in any extreme off-road maneuvers such as jumping. Failure to observe this warning may result in serious personal injury and/or severe damage to your vehicle.

⚠ WARNING
Many states and municipalities have laws restricting bumper heights and vehicle lifts. Consult state and local laws to determine if the changes you intend to make to the vehicle comply with the law.

⚠ WARNING
The installation of larger tires may reduce the effectiveness of the braking system.

⚠ WARNING
Always wear eye protection when operating power tools.

⚠ WARNING
Before you install this kit, block the vehicle tires to prevent the vehicle from rolling.

⚠ WARNING
Accidental deployment of the air bag can result in serious personal injury or death. To avoid accidental deployment during installation of the kit, the Supplemental Restraint System (SRS, or airbag) must remain deactivated. Do not allow anyone near the airbag during installation. Refer to the factory service manual or owner's manual for the recommended procedure to disable the SRS. After you install the kit, reactivate the SRS before driving the vehicle.

NOTE
Performance Automotive Group recommends using the Loctite® supplied in the kit on the threads of all kit nuts and bolts unless specified otherwise in these instructions.

⚠ WARNING
Installation of a Performance Automotive Group body lift kit will change the vehicle's center of gravity and handling characteristics both on- and off-road. You must drive the vehicle safely! Extreme care must be taken to prevent vehicle rollover or loss of control, which could result in serious injury or death. Avoid sudden sharp turns or abrupt maneuvers and always make sure all vehicle occupants have their seat belts fastened.

⚠ WARNING
Before you install this kit, read and understand all instructions, warnings, cautions, and notes in this instruction sheet and in the vehicle owner's manual.

⚠ CAUTION
Proper installation of this kit requires knowledge of the factory recommended procedures for removal and installation of original equipment components. We recommend that the factory shop manual and any special tools needed to service your vehicle be on hand during the installation. Installation of this kit without proper knowledge of the factory recommended procedures may affect the performance of these components and the safety of the vehicle. We strongly recommend that a certified mechanic familiar with the installation of similar components install this kit.

⚠ WARNING
DO NOT combine suspension, body, or other lift devices. Use of vehicle with combined lifts may result in unsafe and/or unexpected handling characteristics.

A. Before you start.

NOTE

Kit parts are prefaced by the word *kit* and appear in **bold** print.

1. Read all warnings and instructions completely and carefully before you begin.
2. Check to make sure the kit is complete (refer to the Parts List at the end of this document).

NOTE

If parts are missing from kit, please be prepared to provide the following information:

1. **Name** of purchase location
 2. **Bar Code** on side of box
 3. **Date** above bar code
 4. **Date** inside box cover
 5. **Inspector #** from inside box cover
3. Only install this kit on the vehicle for which it is intended. If anytime during the installation you encounter something different from what is outlined in the instructions, call technical support at (928) 636-3134.
 4. Park the vehicle on a clean, dry, flat, level surface and block the tires so the vehicle cannot roll in either direction.
 5. Special tools needed
 - a. Welder (or access to a professional welding shop)
 - b. Die grinder (or other tool capable of cutting thick metal)
 - c. 1/2" drill bit
 - d. Torx head bits (T-47 among others)
 6. Disconnect the negative cable first, then the positive cable from the battery.

7. Airbag fuse

⚠ NOTE

The location of the fuse panel may vary; check the owner's manual.

- a. Remove the kick panel cover and fuse panel cover on the passenger side.
- b. Remove two airbag fuses (#19 - 10A; #27 - 5A) from the fuse panel.

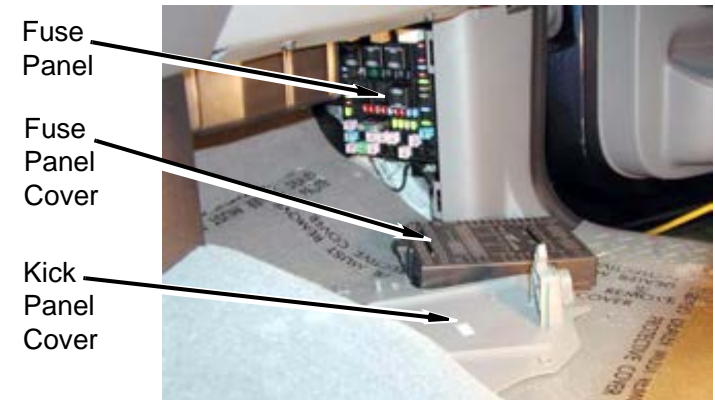
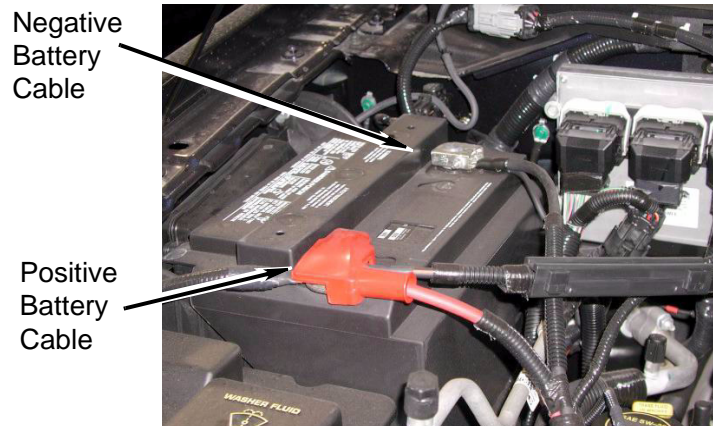

B. Get ready to install the kit

1. Front bumper

- a. Measure and record the distance between the front bumper and the fenders for future reference.

Driver Side _____ Passenger Side _____

- b. **(Vehicles with tow hooks)** Remove four bolts and two tow hooks from the frame ends.

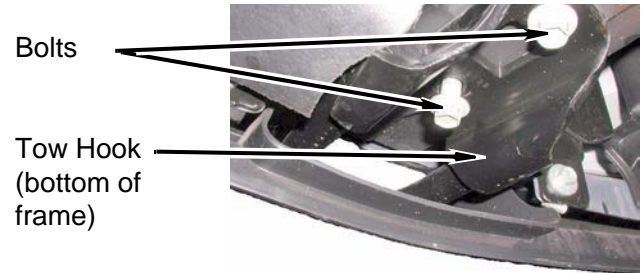

- c. **(Vehicles with fog lamps)** Disconnect the wiring harness connector from each fog lamp.

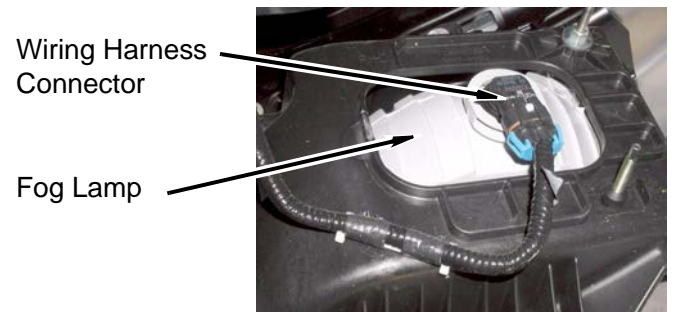

- d. Remove nine push pins and the air flap from the front bumper and radiator lower support.

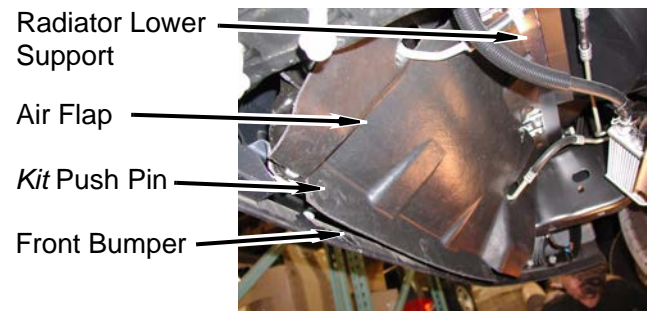

- e. Remove four push pins holding the radiator air flaps to the frame near the A/C condenser (driver and passenger side).

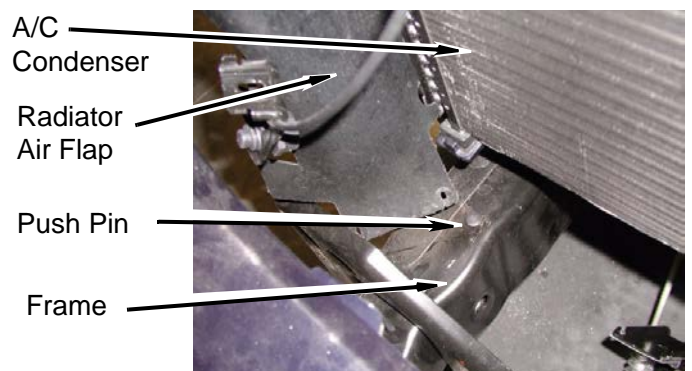

- f. Remove five bolts and grille stops from the top of the front bumper.

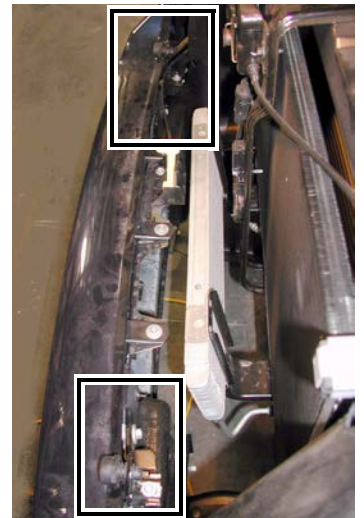

- g. Remove one bolt and the hood release mechanism from the top of the front bumper.

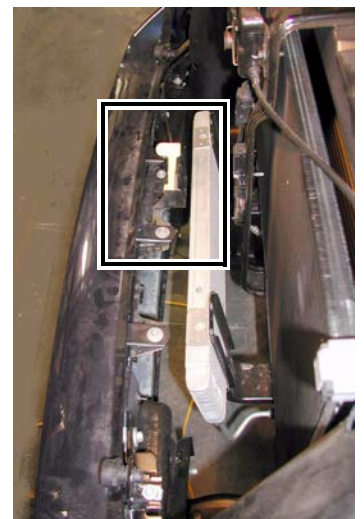
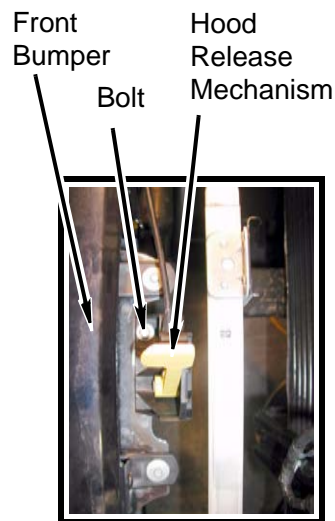

- h. Remove four nuts and the front bumper from the frame flanges.

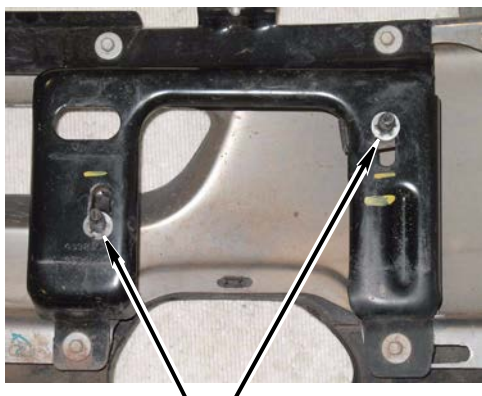

Bumper mounting bolts (captive) on the bumper mounting bracket

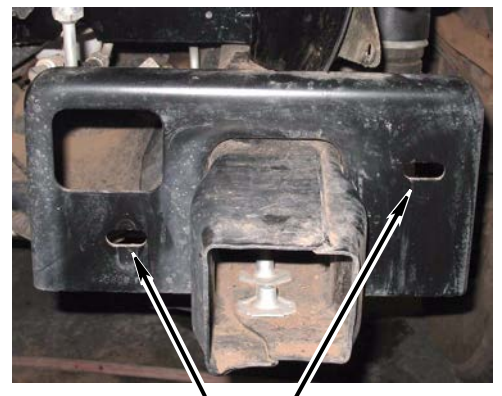

Remove the bumper mounting nuts from behind the frame flange

- i. Remove two screws and the automatic transmission cooler from the radiator lower support. Carefully let the cooler hang by the fluid lines or rest on the ground.

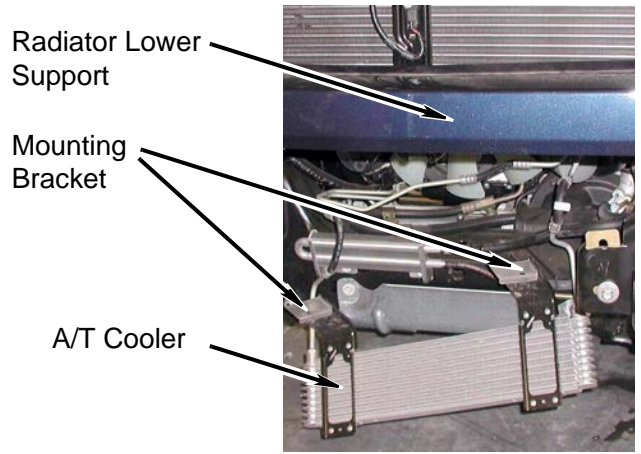

2. Under the hood (air intake duct)

- a. Remove the bolt holding the air intake duct to the air intake duct bracket.
- b. Remove the air intake duct from the air filter housing and the driver side inner fender.

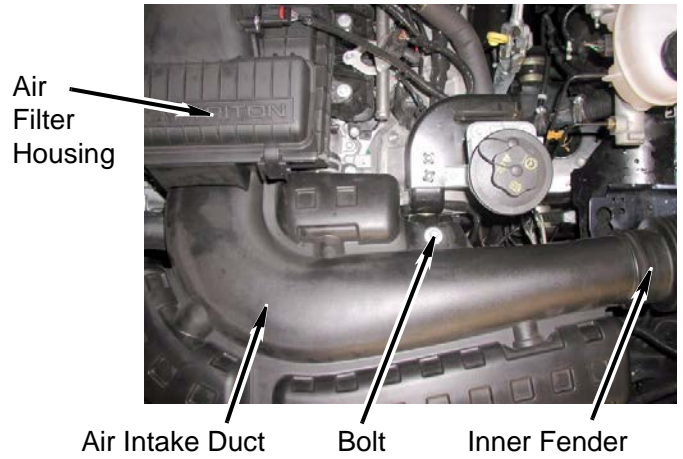

- c. Remove two nuts and the air intake duct bracket from the power steering reservoir bracket.

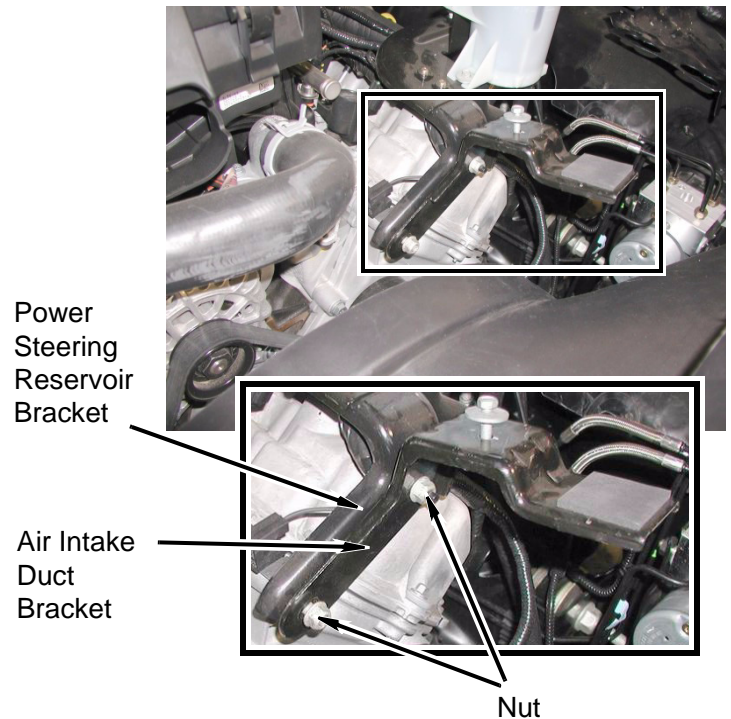

3. Under the hood (fan shroud)

- a. Carefully remove seven push pins and the shroud from the top of the radiator and fan shroud.



⚠ WARNING

If the engine cooling system is hot, the coolant will be **HOT** and **UNDER PRESSURE**. To prevent serious personal injury, wait until the cooling system is completely cool before removing the cap from the coolant overflow reservoir.

- b. Remove the cap from the coolant overflow reservoir.

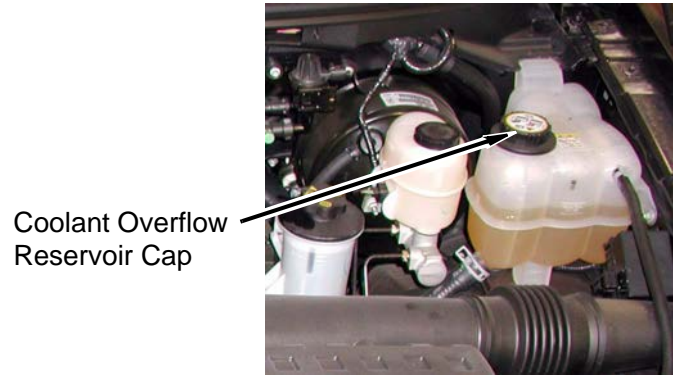

- c. Open the petcock (drain cock) on the bottom of the radiator (passenger side) and allow the coolant to drain into a clean container.
- d. Disconnect the upper hose from the radiator.

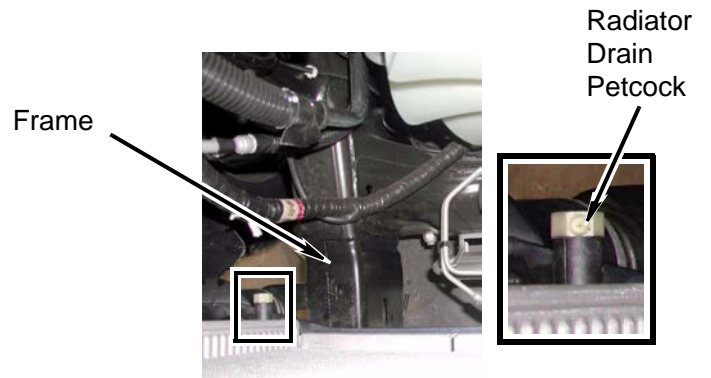

- e. Remove one nut and the upper radiator hose bracket from the engine.

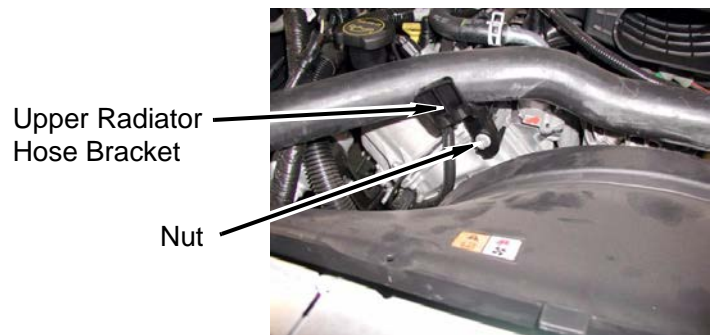

- f. Remove the wiring harness clip from the passenger side of the fan shroud.

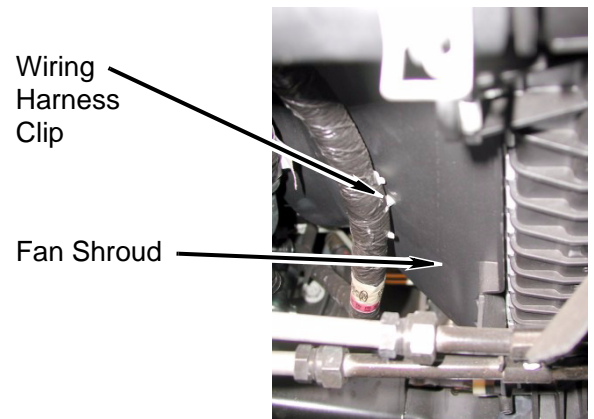

- g. Remove two bolts holding the fan shroud to the radiator.

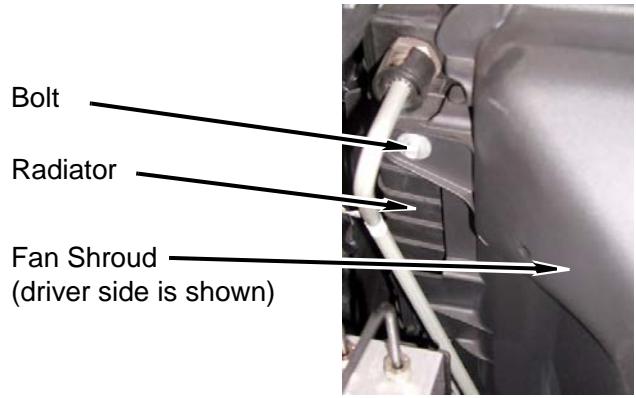

NOTE
 A special tool supplied by Ford allows the removal of the fan and fan clutch from the pulley.

- h. Remove four bolts and the fan from the fan clutch. Let the fan rest on the fan clutch shaft.

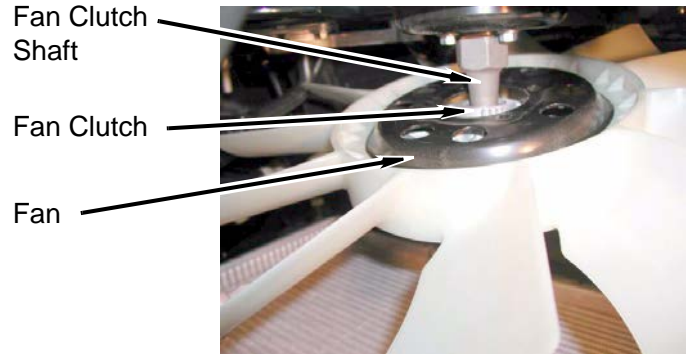

- i. Remove two bolts and the upper radiator mounting brackets (with bushings) from the radiator upper support and radiator. This will allow the radiator to move around, making it easier to remove the fan shroud.

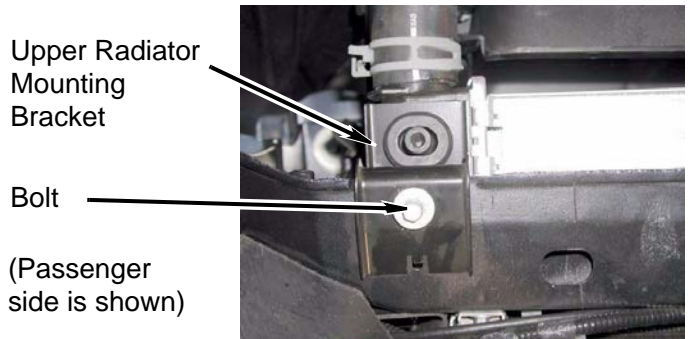

- j. Remove the fan shroud from the radiator retaining clips, then remove the fan shroud from the vehicle.

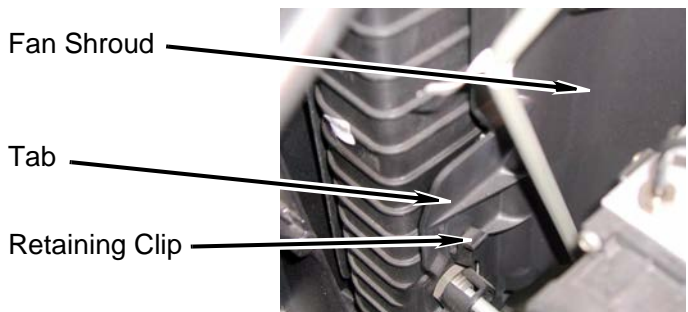

4. Under the hood (miscellaneous)

- a. Disconnect the ABS sensor wiring harness from the push clip at both front fender wells.

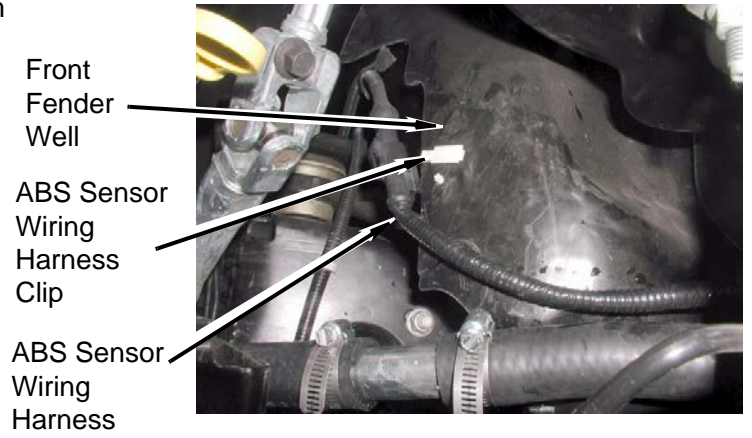

- b. Remove the bolt and the ground strap from the firewall.

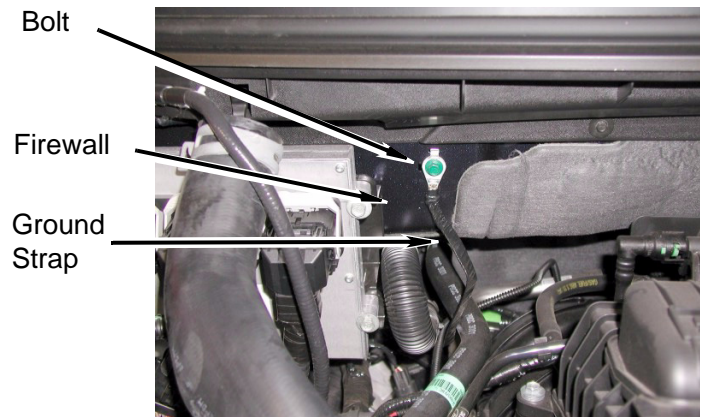

- c. Remove two bolts and the solenoid valve assembly from the firewall.

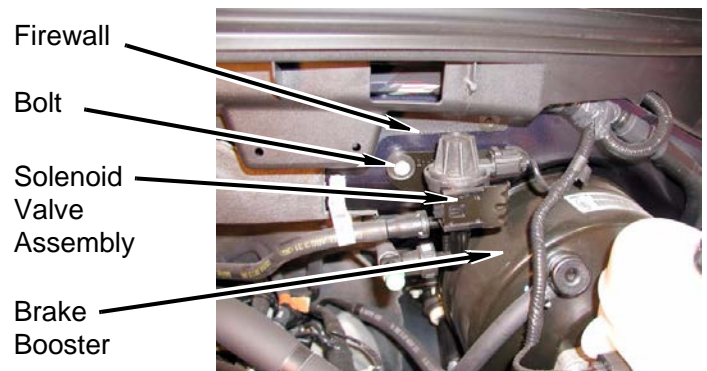

⚠ NOTE

Ensure coolant has been drained from reservoir.

- d. Cut the hose between the coolant overflow reservoir and the engine, about 6" below the coolant overflow reservoir.

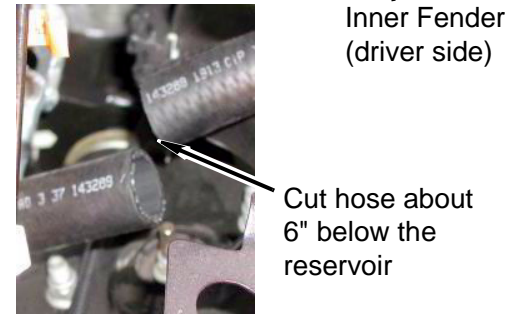
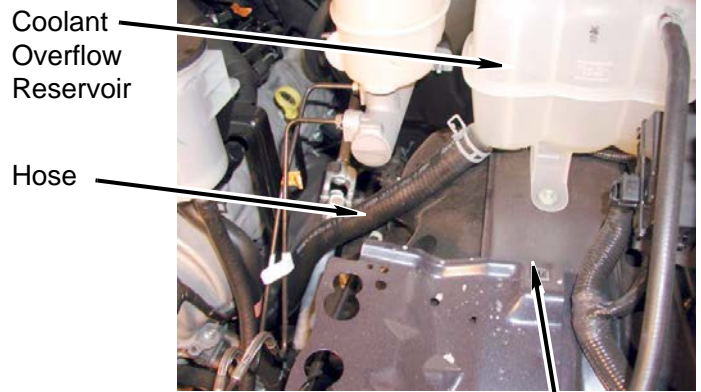

- e. Remove four bolts holding the ABS brake controller side bracket on the frame (driver side).



ABS Brake Controller Side Bracket

Bolt

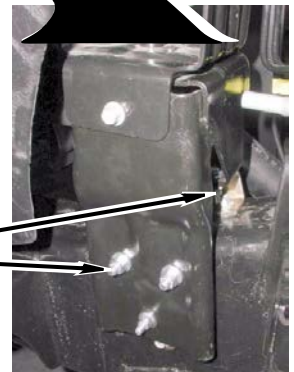

5. Along the frame / under the cab

- a. Remove the brake line from the retainer on the frame (driver side, below the steering shaft U-joint, on the inboard face of the frame).

Frame

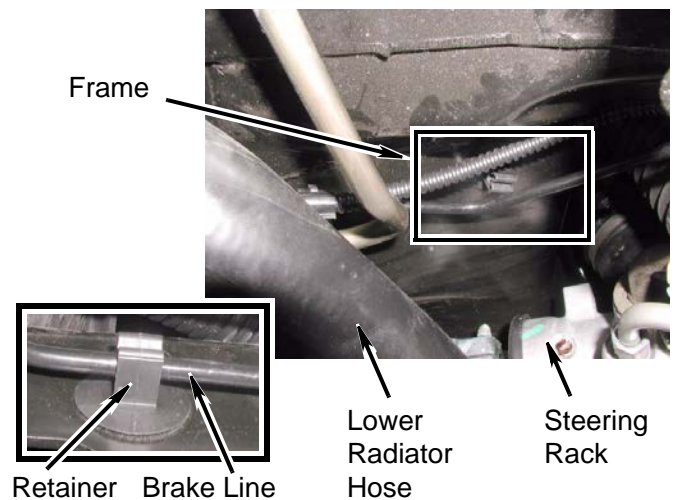

- b. Remove one bolt and the ground strap from the body.

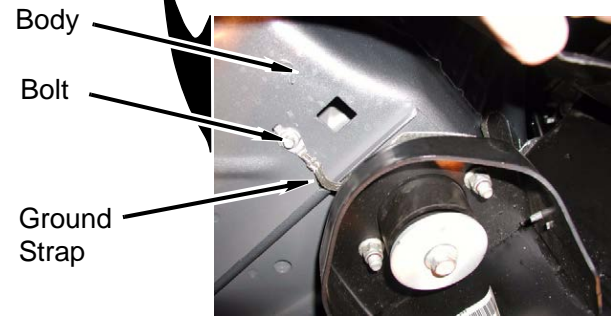

- c. Apply the parking brake.
- d. Clamp the parking brake cable with a pair of vice grips near the rear cable sheath that leads to the brake drum. This will prevent the brake spring tension from pulling the cable into the rear sheath.

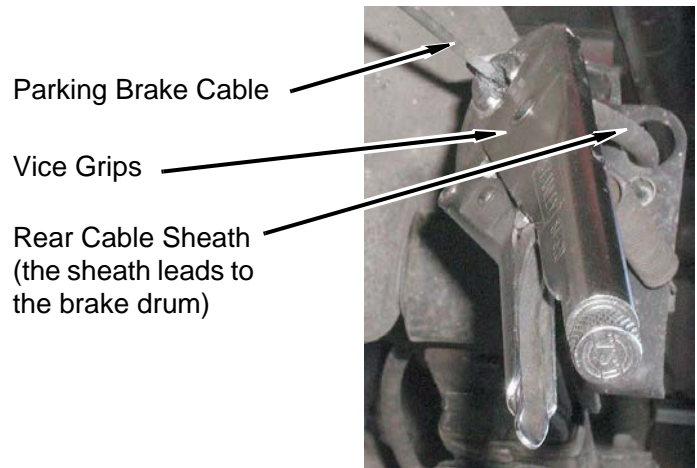

- e. Release the parking brake.
- f. Pull the front cable sheath toward the front of the vehicle (away from the cable mount) to remove the end of the sheath from the hole, then pull the cable out through the slot.

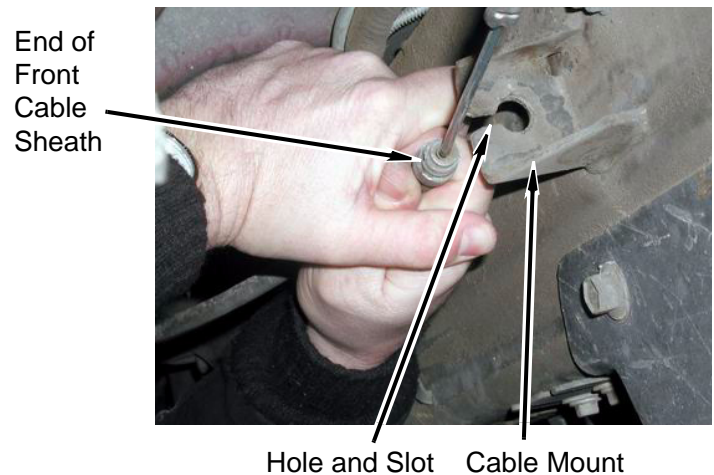

- g. Remove the transmission shift cable from the clip on the transmission bell housing (driver side).

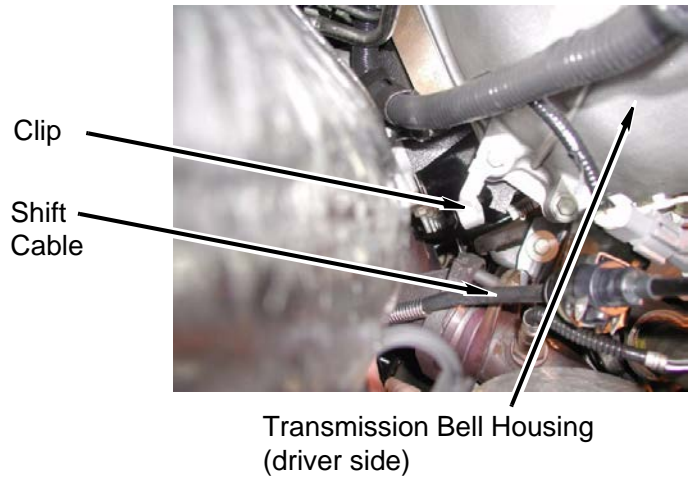

- h. Remove two bolts and the transmission shift cable bracket from the transmission.

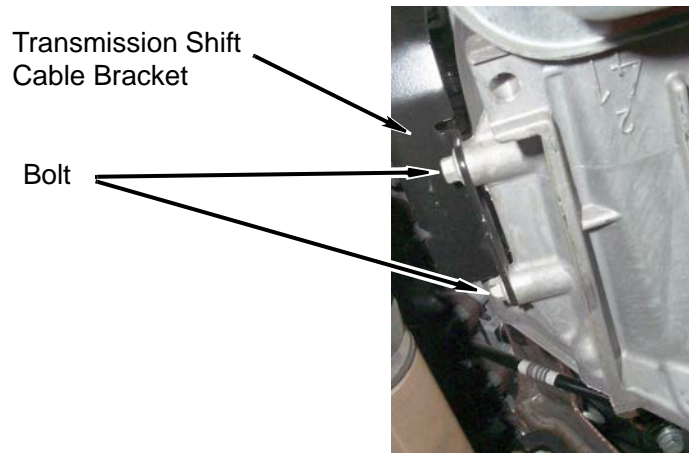

6. Inside the cab (steering U-joint)

⚠ WARNING

Accidental deployment of the air bag can result in serious personal injury or death. To avoid accidental deployment during installation of the lift kit, the Supplemental Restraint System (SRS) must remain deactivated. Do not allow anyone near the airbag during installation. Refer to the factory service manual or owner's manual for the recommended procedure to disable the SRS. After kit installation, the SRS must be reactivated before driving the vehicle.

⚠ CAUTION

If you fail to perform the following step, the airbag clockspring could be damaged if you turn the steering wheel while the steering shaft is disconnected.

- a. Set the front wheels straight ahead and center the steering wheel. Strap the steering wheel so it can't be accidentally turned.
- b. Under the dash, remove the steering U-joint bolt. Slide the U-joint down to separate it from the steering wheel shaft.

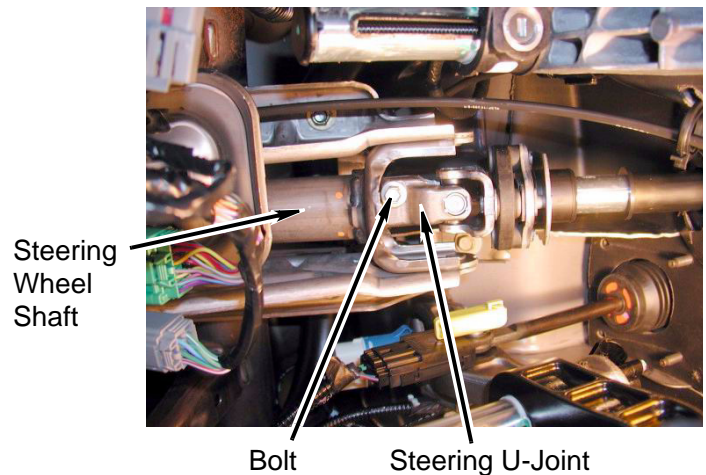

7. **(Vehicles with manual-shift 4WD)** Inside the cab (transfer case shift lever)

- a. Ensure the transfer case is in Neutral.
- b. Remove the shift knob from the transfer case shift lever.
- c. Remove four screws and the upper shift boot from the lower shift boot.
- d. Remove four bolts and the lower shift boot from the cab floor.
- e. Remove one bolt and the transfer case shift lever from the linkage.

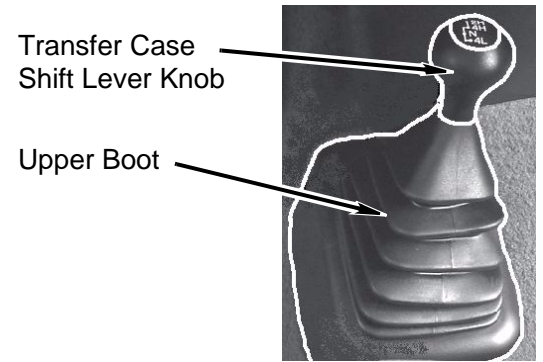

8. Inside the cab (interior components)

- a. Remove two scuff plates (driver and passenger side) from the cab floor.



- b. Remove the hood release handle cover from the driver side kick panel.
- c. Remove two kick panels (driver and passenger side) from the cab.



- d. Fold the rear seat bottom up. Remove two Torx bolts holding the rear seat frame to the floor (driver and passenger side).

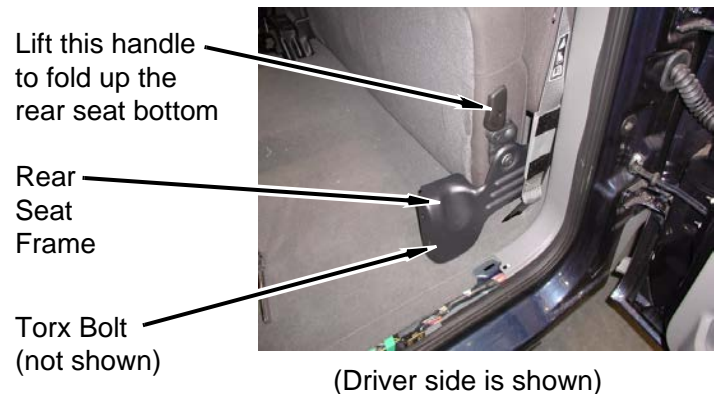

- e. Remove two nuts from the seat belt cover. Lift the seat belt cover off of the studs.

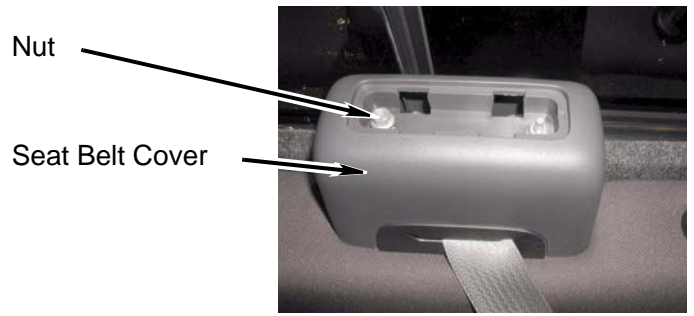

⚠ CAUTION
Sharp metal pieces protrude from the bottom edge of the seatback. When removing the seatback, be careful to avoid tearing the seat bottom and/or causing personal injury. Remove the seatback with the help of an assistant.



- f. Release the latches at the bottom of the seatback (driver and passenger side), pull the seatback upward, and remove it from the cab.

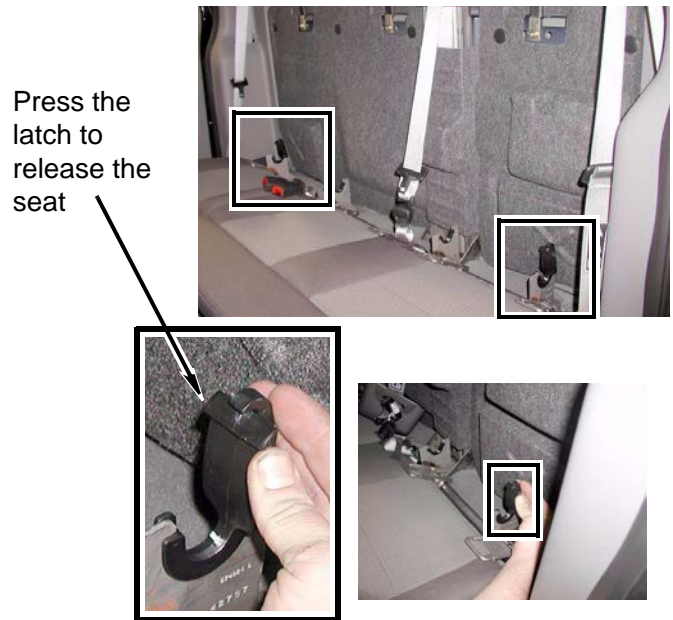

9. Fuel filler

⚠ WARNING

Use extreme caution when working near the fuel lines and the fuel tank. Clean up spilled fuel immediately. A spark could cause an explosion or fire resulting in serious personal injury and property damage.

- a. Remove the gas cap.
- b. Remove three bolts and the fuel filler assembly from the bed.

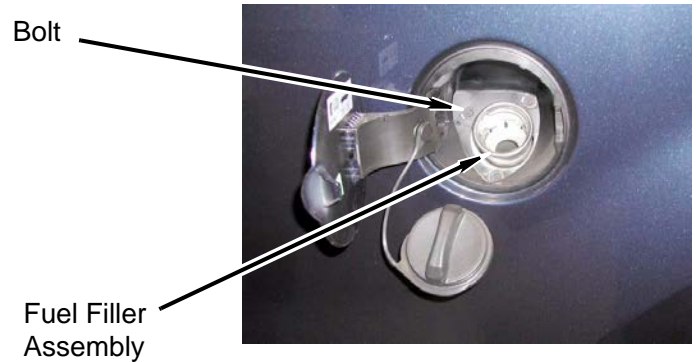

- c. Loosen the hose clamp holding the fuel filler assembly to the bed mounting tongue. Slide the clamp away from the tongue to allow the fuel filler assembly to separate from the tongue and bed during lifting.

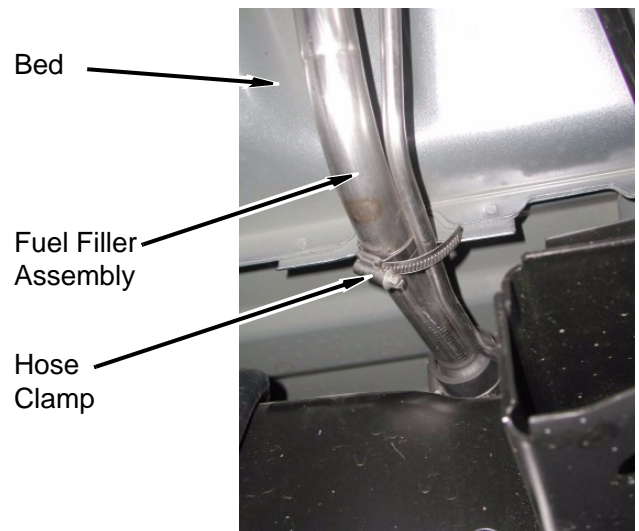

10. Remove the spare tire (refer to the owner's manual).

11. Rear bumper

- a. Measure and record the distance between the rear bumper and the bottom of the tailgate (driver and passenger sides) for future reference.

Driver Side _____ Passenger Side _____

- b. Disconnect two license plate light connectors from the rear bumper.
- c. Disconnect the wiring harness clip from the hole in the rear bumper frame.

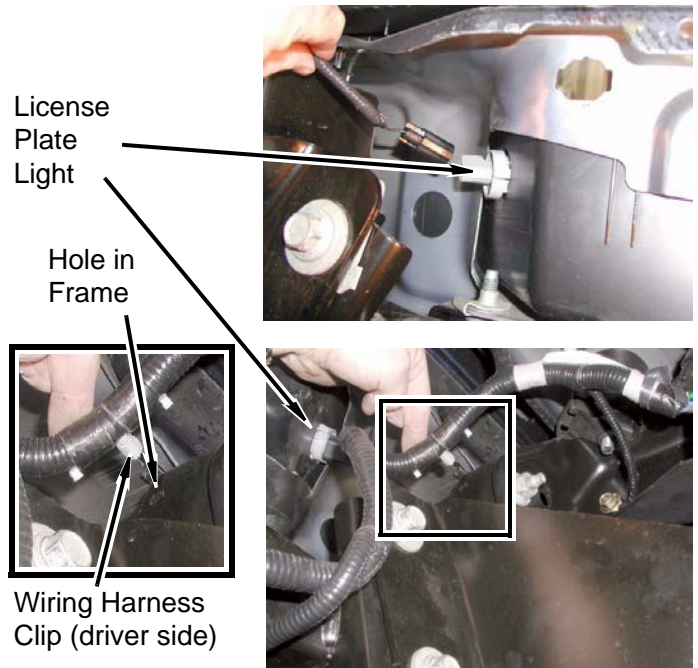

- d. Trailer tow electrical connectors: Slide the small (4-pin) connector out of the flange. Remove the gray plastic lock from the large connector, then disconnect the large connector from the bumper.

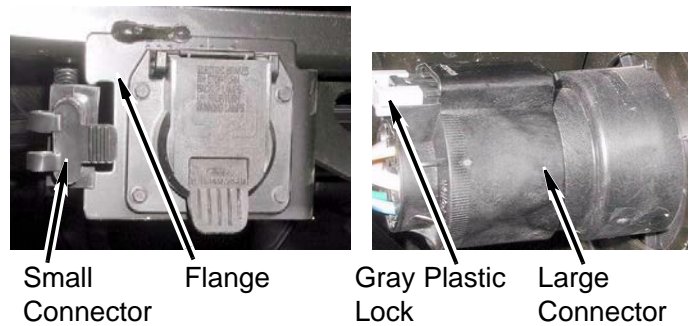

- e. Non-tow hitch models: Remove four nuts, four bolts, and rear bumper from frame rails.
- f. Tow hitch models: Remove six nuts, six bolts and rear bumper from frame rails.

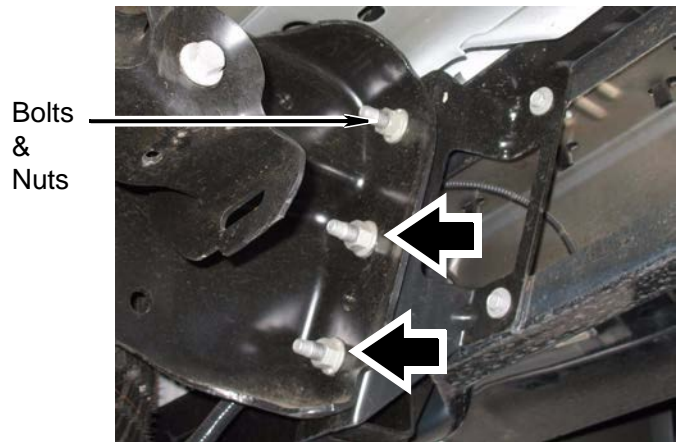

C. Install the *kit* lift blocks (cab)

- 1. Slide the bed rearward.
 - a. Measure and record the distance between the cab and the bed for future reference.
 Driver Side _____ Passenger Side _____
 - b. Using a T-47 Torx head bit, remove the bed-to-frame mounting bolts.



Bolts (T-47 Torx Head)

- c. Slide the bed rearward (away from the cab) about 1". Ensure the fuel filler does not get hung up on the bed.

- 2. At cab mounting locations C1D and C1P, remove two bolts, nuts, and lower bushings from frame and radiator lower support.

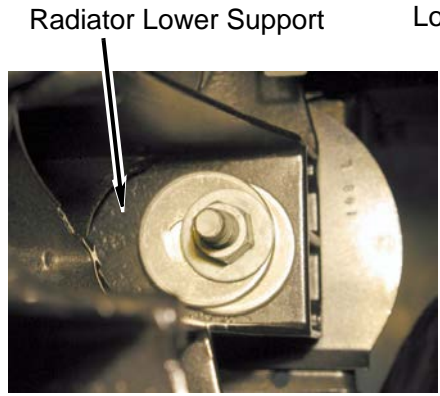

Radiator Lower Support

C1D and C1P
(viewed from top)

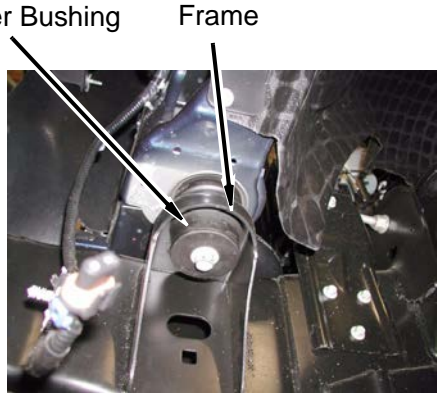

Lower Bushing Frame

C1D and C1P
(viewed from bottom)

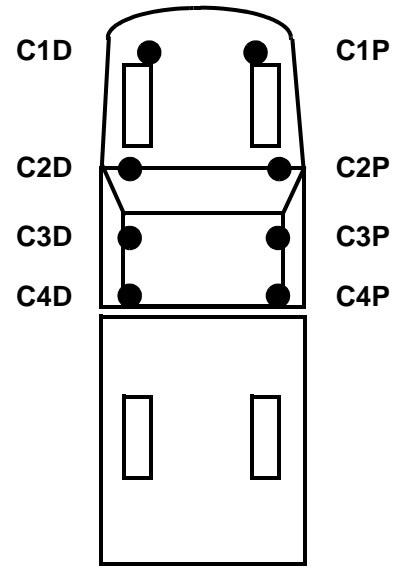

Cab Mounting Locations

- 3. Loosen the cab mounts on the driver side.
 - a. Lift the carpet and loosen the nut at C2D.

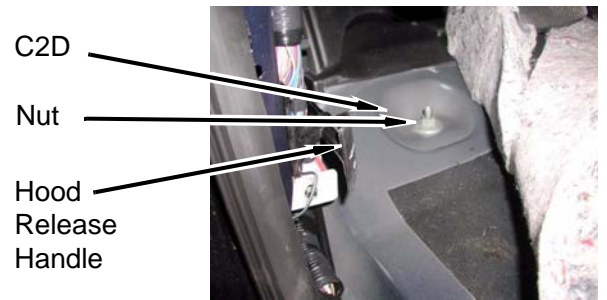

- b. Lift the carpet and loosen the bolt at C3D.

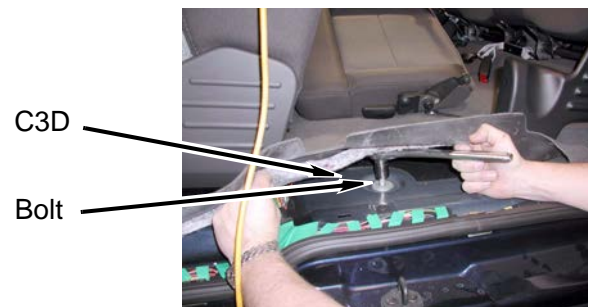

c. Loosen the bushing nut at C4D.

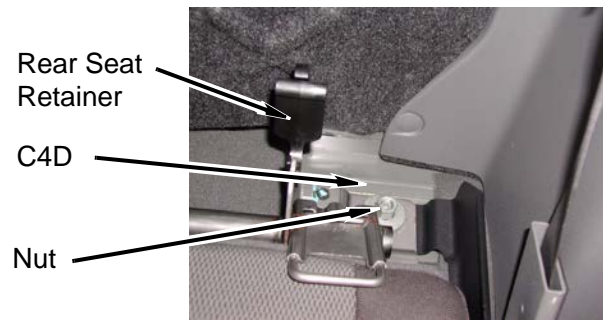

4. Lift the passenger side of the cab.

a. Lift the carpet and remove the nut from the bolt at C2P.

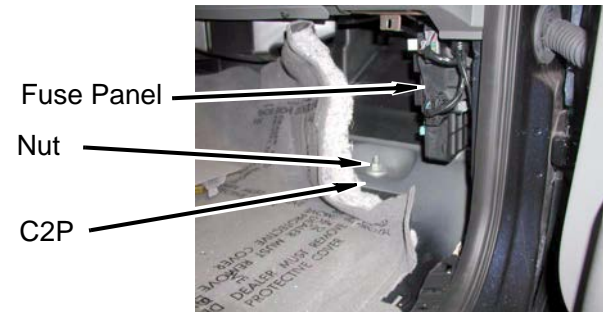

b. Remove two nuts from the C2P bushing flange studs.

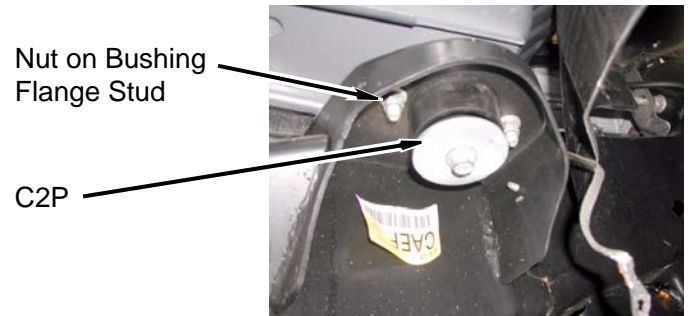

c. Lift the carpet and remove the C3P bolt.

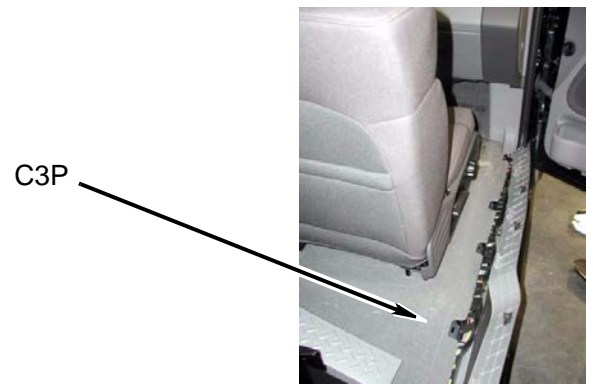

d. Remove the C4P bolt from the cab and bushing.

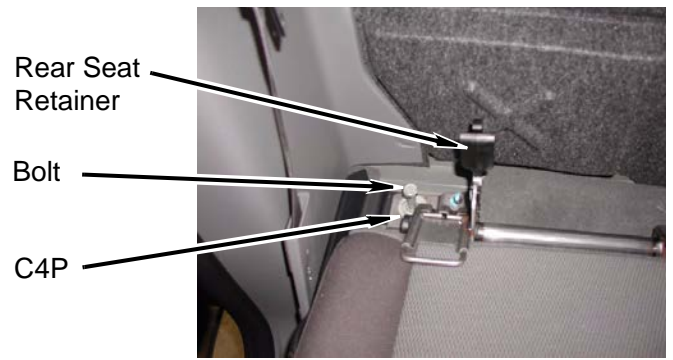

e. Remove two nuts from the C4P bushing flange studs.

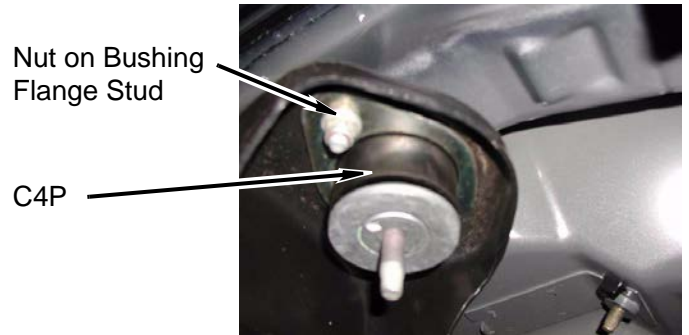

⚠ WARNING

Use extreme caution when lifting the body from the frame. To prevent serious personal injury, ensure the lifting device is securely placed. Keep your hands out from between the body and frame.

⚠ CAUTION

To prevent damage to the vehicle while lifting the cab, continually check hoses, wires, brake lines, etc. to ensure everything is flexing properly and not binding. It may be necessary to bend the brake lines to gain ample slack. Ensure clearance between bed and cab are maintained.

f. Using a hydraulic jack and a wooden block, slowly lift the passenger side of the cab just high enough to remove the bushings from the frame.

5. Drill out bushing C1P.

- a. Remove bushing C1P from the frame.
- b. Using a 1/2" drill bit, remove the threads in bushing C1P.
- c. Position bushing C1P on the frame.

Drilling is shown while the bushing is installed (drilled from the bottom), but it is easier to drill the bushing while it is removed.

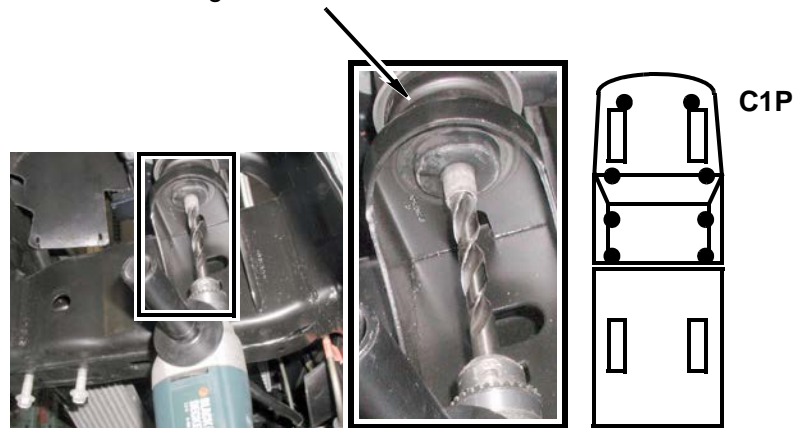

⚠ NOTE

The bolt in bushings C2P, C2D, and C4D is press-fitted into the bushing.

6. Remove the C2P bushing bolt and drill out bushing C2P.
 - a. Remove bushing C2P from the frame.
 - b. Using a hammer, drive the bolt out of the bushing.
 - c. Install bushing C2P on the frame with two nuts.

⚠ CAUTION

DO NOT remove or drill out bushing C3P.

7. Drill out bushing C4P.
 - a. Remove bushing C4P from the frame.
 - b. Using a 1/2" drill bit, remove the threads in bushing C4P.
 - c. Install bushing C4P on the frame with two nuts.

⚠ WARNING

The kit lift blocks must be installed *in addition to* the factory body mounting bushings. Failure to reinstall the factory bushings in their original (stock) locations could result in serious personal injury or damage to the vehicle.

8. Install a *kit* lift block (3" x 3") on top of factory bushings C1P, C2P, C3P, and C4P.
9. Temporarily install a *kit* bolt in bushings C1P, C2P, C3P, and C4P. **Do not tighten.**

C1P: Insert a *kit* bolt (1/2" x 9 1/2") through a *kit* washer (1/2" x 1 3/4"), the lower bushing (cup), the frame, the upper bushing, the *kit* lift block, the radiator lower support, two washers (with slotted hole), a *kit* washer (1/2" USS), and a *kit* nut (1/2" Nylock) on the *kit* bolt.

C2P: Insert a *kit* bolt (1/2" x 9 1/2") through a *kit* washer (1/2" x 1 3/4"), the cab floor, the *kit* lift block, the bushing, the bushing bottom plate, and a *kit* nut (1/2" Nylock).

C3P: Insert a *kit* bolt (12mm-1.75 x 220mm) through a *kit* washer (1/2" x 1 3/4"), the cab floor, the *kit* lift block, and the bushing.

C4P: Insert a *kit* bolt (1/2" x 10") through a *kit* washer (1/2" x 1 3/4"), the cab floor, the *kit* lift block, the bushing, and a *kit* nut (1/2" Nylock).

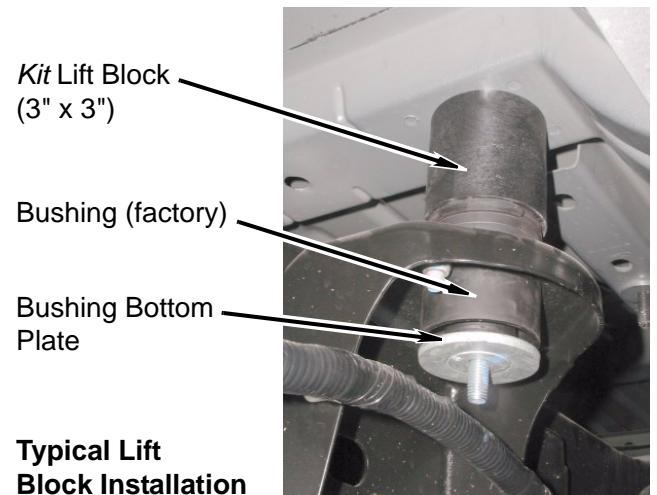
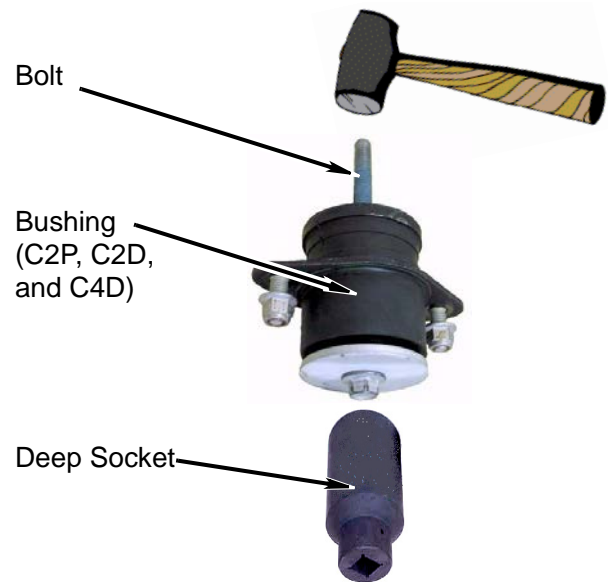

Typical Lift Block Installation

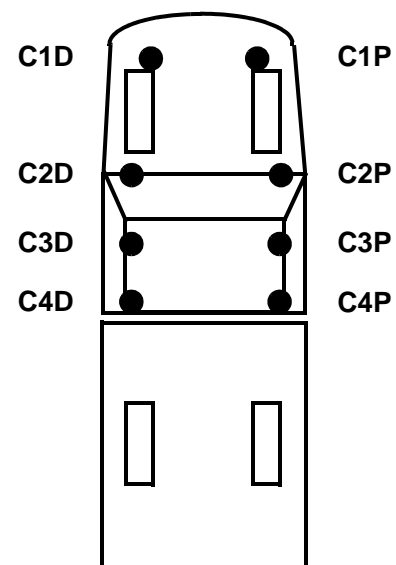

Cab Mounting Locations

10. Lower the cab onto the *kit* lift blocks.
11. Install the *kit* lift blocks on the driver side of the cab.
 - a. For the driver side, repeat steps C.4 through C.10 with the following exceptions for bushing C4D:

The bushing bolt in bushing C4D is press-fitted into the bushing. After you lift the driver side of the cab, remove bushing C4D and use a socket and a hammer to drive out the bolt.

Unlike the bolt at C4P, the bolt at C4D must be installed from the bottom. To install the bolt in C4D, insert a *kit* bolt (1/2" x 10") through the bushing bottom plate, the bushing, the *kit* lift block, the cab floor, a *kit* washer (1/2" x 1 3/4"), and a *kit* nut (1/2" Nylock).

12. Remove the *kit* bolts one at a time, coat the threads with Loctite®, install, and tighten to 55 lb-ft.

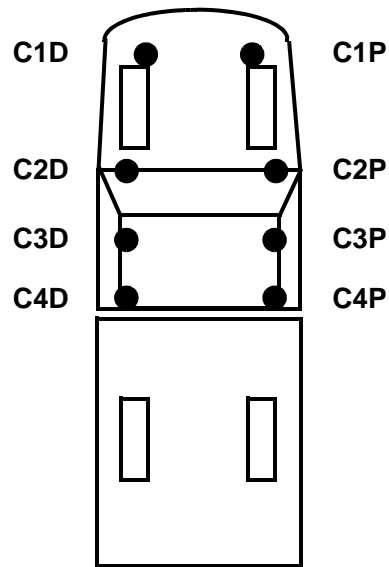

Cab Mounting Locations

D. Install the *kit* lift blocks (bed)

1. Slide the bed forward (toward the cab) until the bed is near it's original position.
2. Using a hydraulic jack and a wooden block on each side of the bed, slowly lift the front end of the bed just high enough to install the *kit* lift blocks.

⚠ NOTE
If a factory plastic piece is installed in any of the bushing mount holes on the frame, remove it.

3. Install two *kit* lift blocks (3" x 3") on the frame at the front mounting pads.

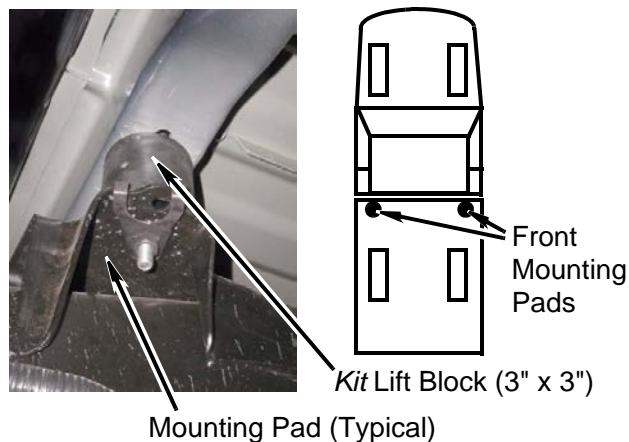

4. Lower the front end of the bed onto the *kit* lift blocks.
5. Using a hydraulic jack and a wooden block on each side of the bed, slowly lift the rear end of the bed just high enough to install the *kit* lift blocks.

6. Install a *kit* lift block at all other frame mounts (four mounts on vehicles with 6 1/2' bed; six mounts on vehicles with 5 1/2' bed and 8' bed).
7. Lower the bed onto the *kit* lift blocks.
8. At each bed mount, install a *kit* bolt (12mm-1.75 x 180mm) through a *kit* washer (1/2" x 1 3/4" plated), the bed, the *kit* lift block, and the frame mounting pad. DO NOT tighten.
9. Position the bed according to the measurement in step C.1.a.
10. Remove the *kit* bolts one at a time, coat the threads with Loctite, and install. Tighten the 12mm *kit* bolts to 55 lb-ft. Tighten the 10mm *kit* bolts to 32 lb-ft.

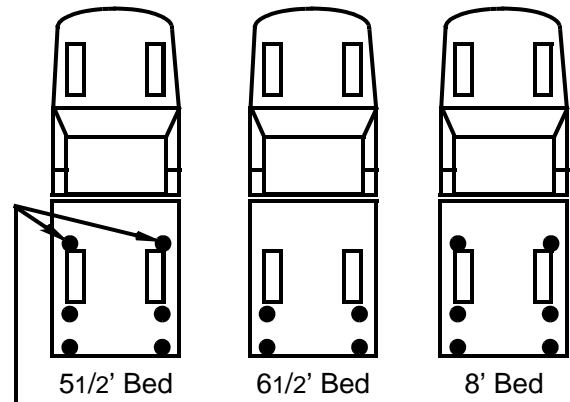

Mounting Pads
(Except Front)

If the bolts at these mounts are installed from below, install a *kit* bolt (10mm-1.50 x 100mm) and a *kit* washer (3/8" USS) from below.

E. Modify the spare tire mechanism

1. Remove two bolts and the spare tire cranking mechanism from the mounting plate.

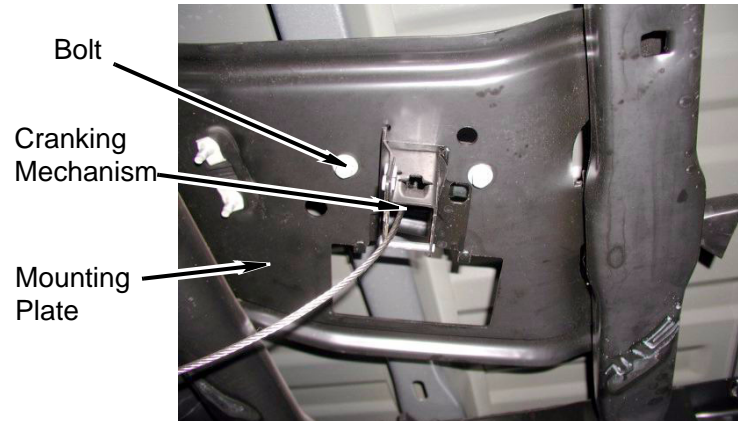

2. Cut material from the mounting plate.

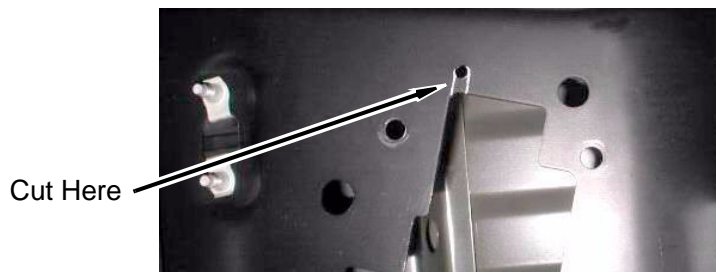

3. Install two *kit* lift blocks (3" x 2") and the cranking mechanism on the mounting plate with two *kit* bolts (10mm-1.5 x 100mm) and *kit* washers (3/8").

Kit Bolt (10mm - 1.5 x 100mm),
Washer (3/8")

Kit Lift Block
(3" x 2")

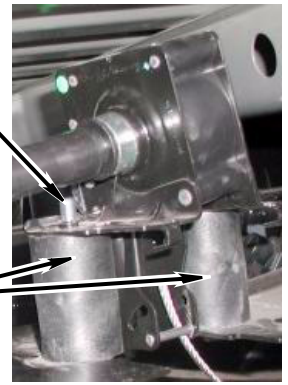

4. Insert the guide tube through the hole in the *kit* bracket.
5. Install the *kit* bracket and guide tube on the spare tire mounting plate using a *kit* bolt (3/8" x 1"), *kit* washer (3/8"), and *kit* nut (3/8" Nylock).

Guide
Tube

Kit Bracket

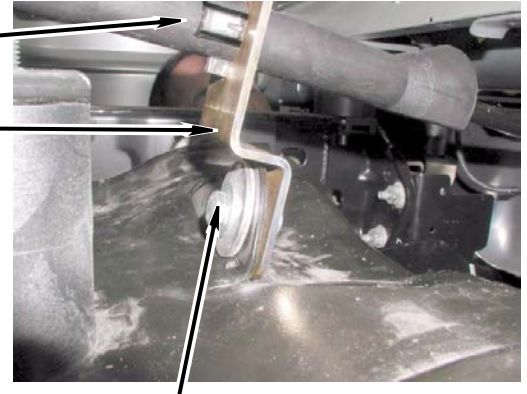

Kit Bolt (3/8"-13 x 1"),
Washer (3/8"),
Nut (3/8" Nylock)

F. Rear Bumper

1. Mark driver and passenger side of bumper as shown so bumper will clear bumper support when raised 3".

Bumper
Support

Mark & Cut

Bumper

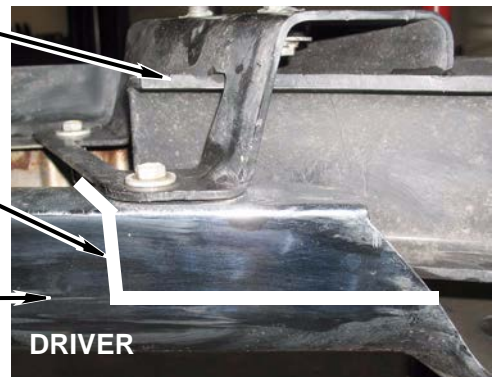

2. Remove six bolts and bumper support (or hitch) from bumper.

Bolts

Bumper

Bumper
Support



3. Cut bumper along marked lines.

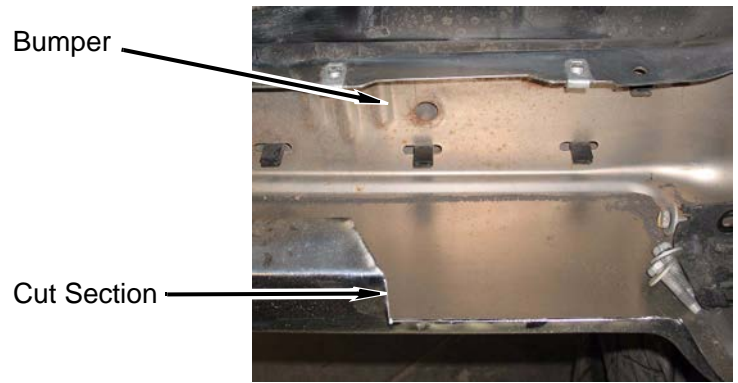

4. Install *kit* brackets (bumper, rear) onto driver and passenger side with four O.E. bolts. DO NOT TIGHTEN. Mark two holes in lower *kit* bracket (bumper, rear). Remove four O.E. bolts and *kit* brackets (bumper, rear).

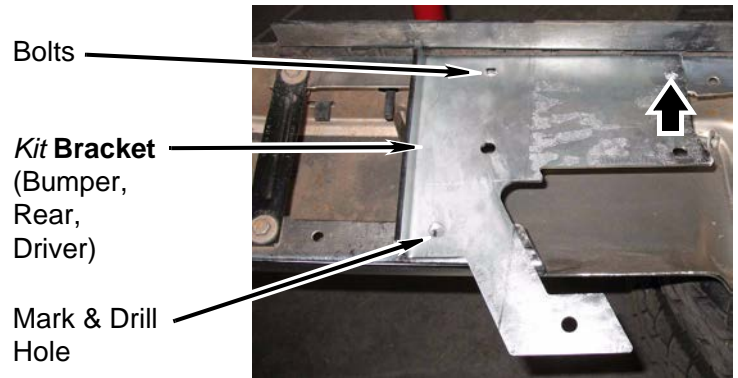

5. Drill two 3/8" holes into bumper at marked locations.

6. Install *kit* bracket (bumper, rear) onto driver and passenger side bumper with four O.E. bolts, two *kit* bolts (3/8" x 1"), four *kit* washers (3/8" SAE) and two *kit* nuts (3/8" Nylock).

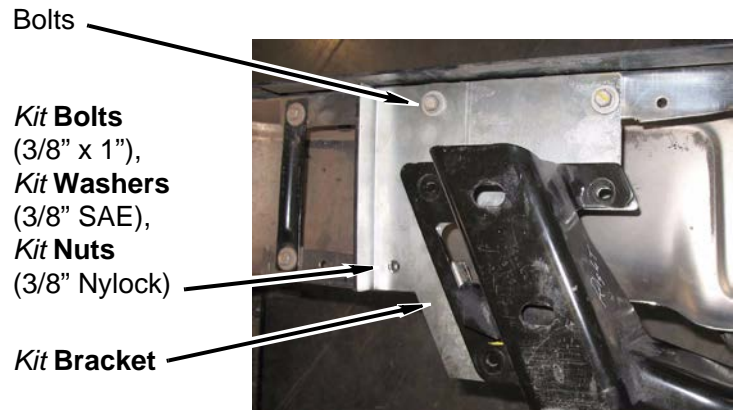

7. Position *kit* bracket (bumper, rear, middle) between bumper and bumper support.

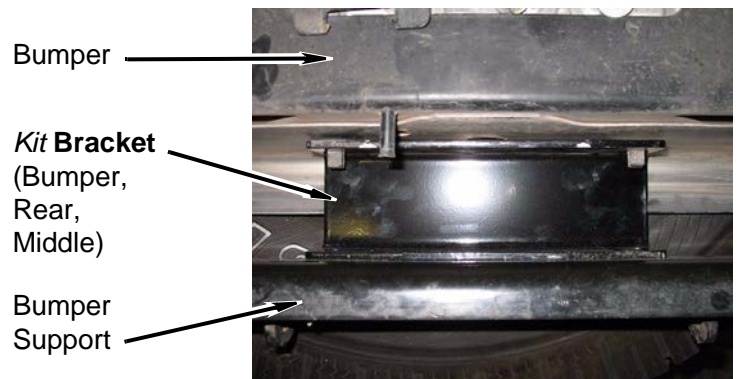

8. Install bumper support onto *kit* brackets (bumper, rear) with four *kit* bolts (5/16" x 1"), eight *kit* washers (5/16" SAE), four *kit* nuts (5/16" Nylock), two *kit* bolts (3/8" x 1"), four *kit* washers (3/8" SAE) and two *kit* nuts (3/8" Nylock). If bumper support interferes with bumper, trim bumper.

Kit Bolt (3/8" x 1"),
Kit Washers (3/8" SAE),
Kit Nut (3/8" Nylock)

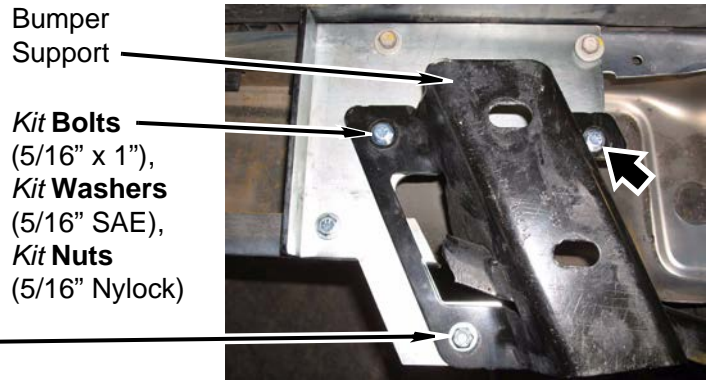

9. Install *kit* bracket (bumper, rear, spacer) onto bumper support with two *kit* bolts (1/2" x 2"), four *kit* washers (1/2" SAE) and two *kit* nuts (1/2" Nylock).

Kit Bolt (1/2" x 2"),
Kit Washers (1/2" SAE),
Kit Nut (1/2" Nylock)

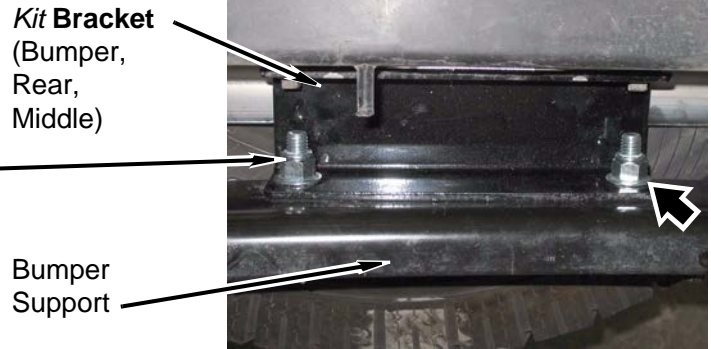

10. Install trailer light harness bracket (driver side ONLY) onto bumper support with *kit* block (3" x 2"), *kit* bolt (8mm x 100mm) and *kit* washer (8mm). Repeat for passenger side.

Kit Bolts (8 x 100mm),
Kit Washers (8mm),
Kit Block (3" x 2")



11. Install bumper onto vehicle with four (six for hitch models) O.E. bolts and nuts. Adjust bumper to previous measurements and TIGHTEN all hardware.

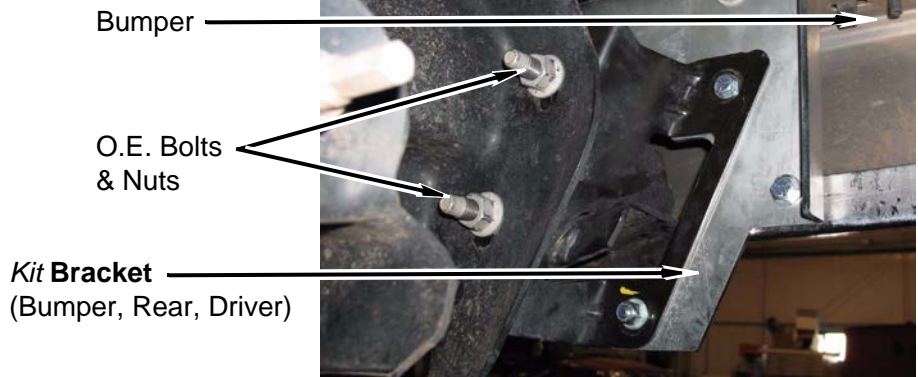

12. Connect two license plate lights in rear bumper.

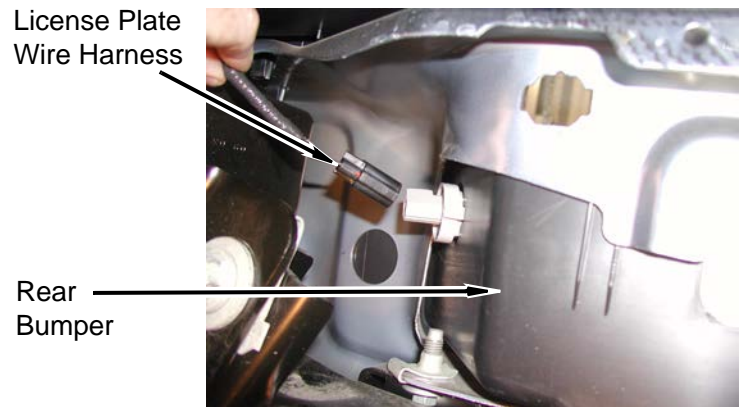

13. Install trailer light wiring harness onto bracket.

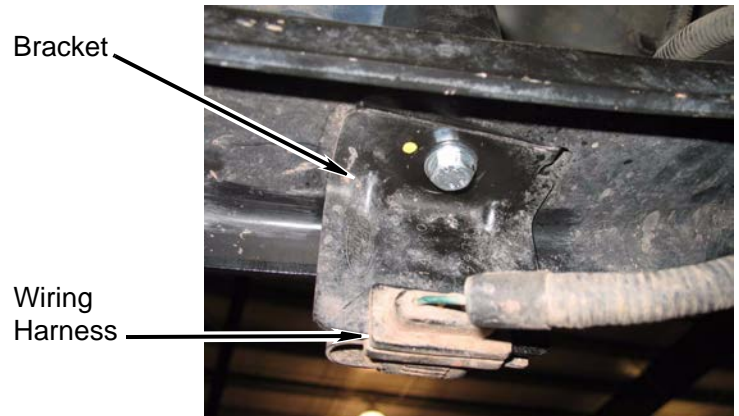

14. Trailer tow electrical connectors: Install large connector onto bumper. Install small (4-pin) connector into flange.

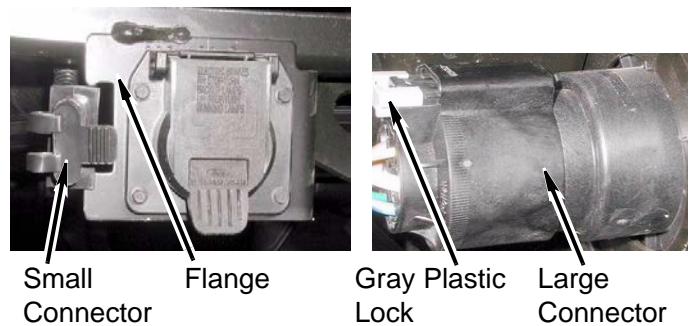

G. Install the *kit* bed crush blocks

1. Set a *kit* crush block into position on each frame mounting pad.
2. At each *kit* crush block, install a *kit* bolt (7/16" x 1"), two *kit* washers (7/16"), and a *kit* nut (7/16" Nylock).

Tip: To install the washer at the bolt head, use a screwdriver to push the washer through the bed channel into position above the crush block. To install the bolt, put a piece of duct tape on the end of a screwdriver with the sticky side of the tape exposed. Set the bolt on the tape and install the bolt.

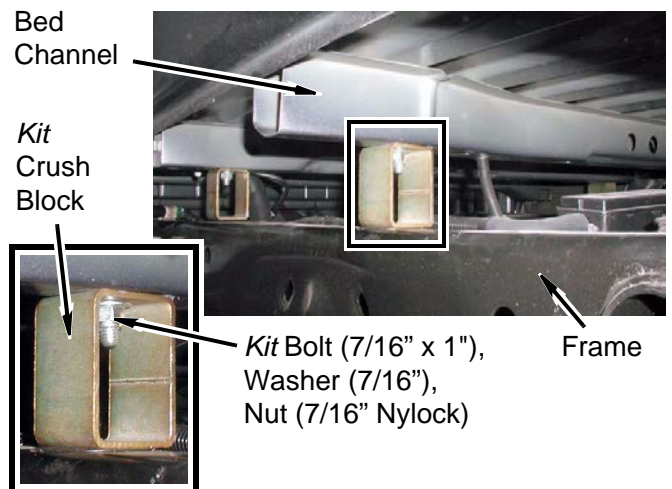

H. Extend the fuel filler hose

⚠ WARNING

Use extreme caution when working near fuel lines and the gas tank. Clean up spilled fuel immediately. A spark could cause an explosion or fire resulting in serious personal injury and property damage.

1. Remove the clamp holding the filler hose to the gas tank. Disconnect the filler hose from the gas tank.
2. Install the *kit* pipe (1 1/4" x 2 1/2"), *kit* hose (1 3/8" x 2 1/4"), two *kit* clamps (#28), and the clamp between the filler hose and the gas tank.
3. Gently bend the fuel tank vent tube to relieve tension on the gas tank and rubber vent hose.
4. Install the fuel filler assembly on the bed with three bolts.
5. Install the fuel filler neck on the bed mounting tongue with the clamp.
6. Install the gas cap.

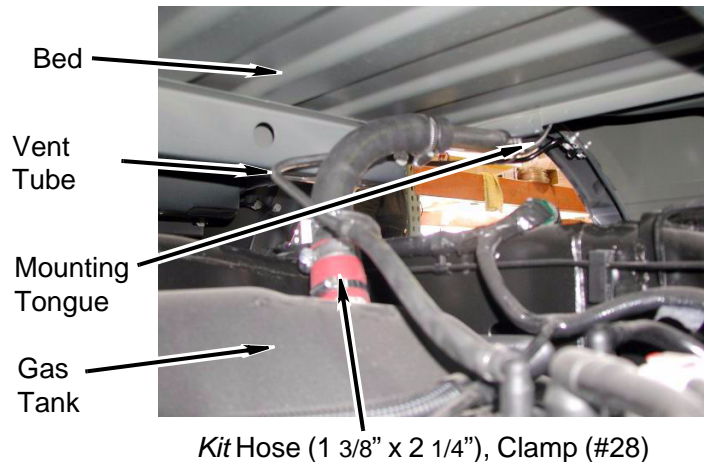
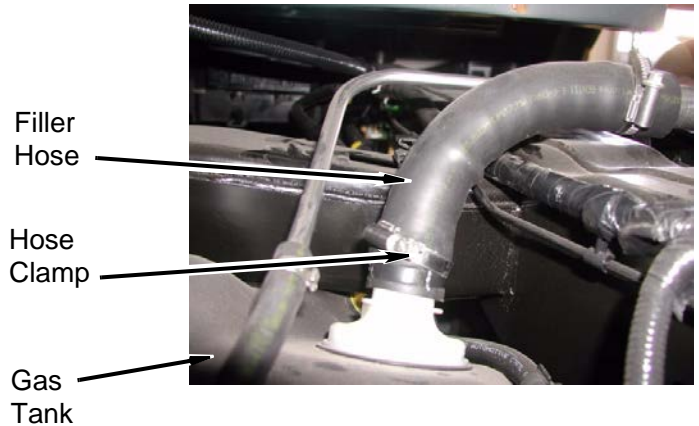

I. Install components under the vehicle

1. Connect the ground strap to the body with the bolt, near bushing C2P.
2. Install the parking brake cable bracket.

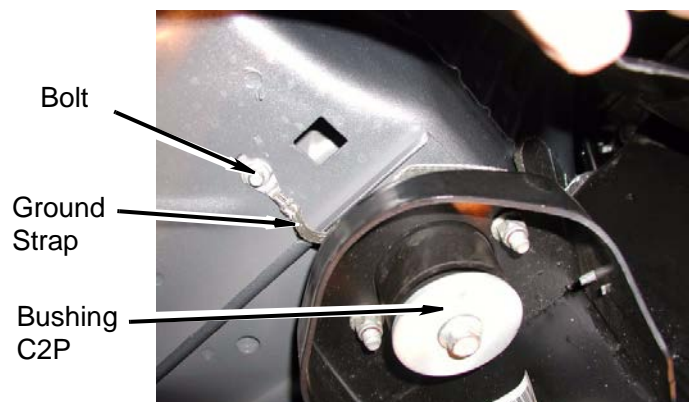

- a. Using the *kit* parking brake cable bracket as a template, drill two 5/16" holes in the parking brake cable mount on the frame.
- b. Install the *kit* parking brake cable bracket on the frame with two *kit* bolts (5/16" x 1"), four *kit* washers (5/16"), and two *kit* nuts (5/16" Nylock).
- c. Insert the parking brake cable through the slotted hole in the *kit* bracket, then snap the end of the cable sheath into the *kit* bracket.
- d. Remove the vice grips from the parking brake cable.
- e. Check the operation of the parking brake.

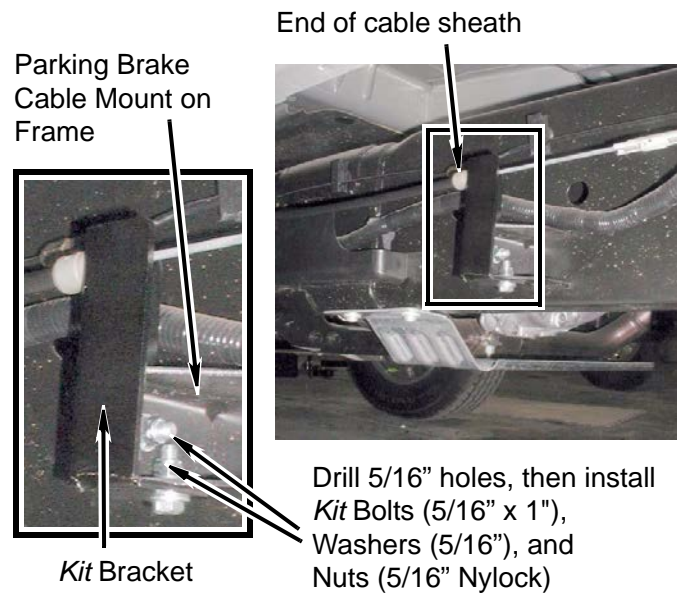

3. Install the *kit* shift cable bracket

- a. Install the *kit* bracket on the transmission with two bolts.

△ NOTE
 If the transmission shift indicator pointer on the column does not properly align with the PRNDL indicator, adjust it using the wheel under the dash until the pointer points correctly to all shift ranges. It might not be possible to make a complete adjustment, so you might have to find a happy medium.

- b. Install the shift cable bracket on the *kit* bracket with two *kit* bolts (5/16 x 1"), four *kit* washers (5/16"), and two *kit* nuts (5/16" Nylock).

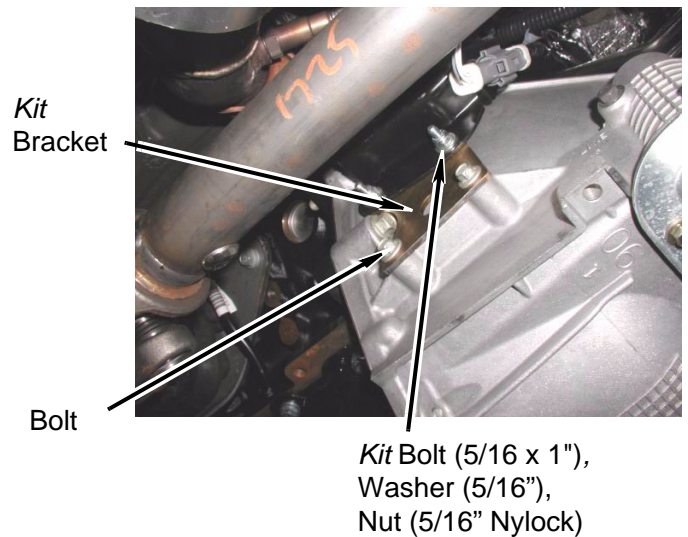

J. (Vehicles with manual-shift 4WD)

Extend the transfer case shift lever

△ WARNING
 During cutting and welding, be careful not to damage any of the parts attached to the shift levers. A certified welder should perform all welding.

1. Scribe a line along the side of the transfer case shift lever (above the bend). Cut the lever into two pieces through the line and deburr as necessary.
2. Position the *kit* transfer case shift lever extension between the two pieces of the transfer case shift lever.
3. Ensure the lines that you scribed are aligned, then weld the extension in place.

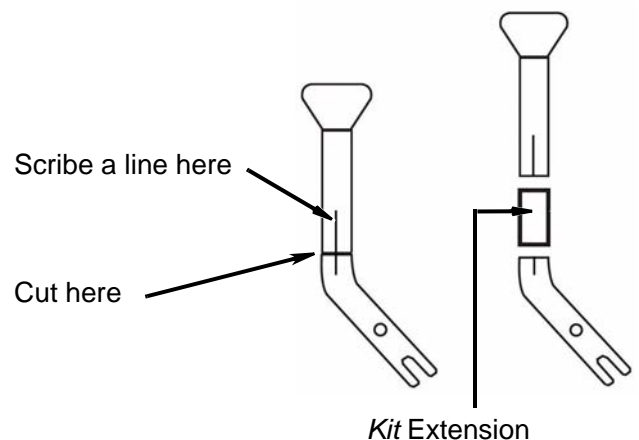

4. Slide the upper shift boot and lower shift boot onto the transfer case shift lever.
5. Install the transfer case shift lever onto the linkage with the bolt. Check the operation of the transfer case shift lever.
6. Set the lower shift boot into position through the hole in the cab floor and install it on the transfer case with four bolts.
7. Install the upper shift boot on the cab floor with four screws.

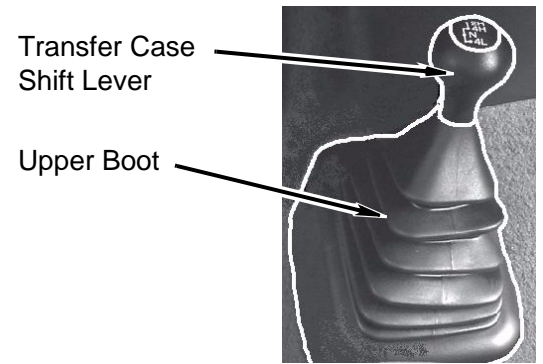

K. Install the interior components

⚠ CAUTION

Sharp metal pieces protrude from the bottom edge of the seatback. When removing the seatback, be careful to avoid tearing the seat bottom and/or causing personal injury. Remove the seatback with the help of an assistant.

1. Install the rear seatback.
 - a. Set the rear seatback into position. Ensure the latches at the bottom of the seatback click into place. Ensure the retainers at the top of the seatback slide into place.
 - b. Install the seat belt holder on top of the seatback with two nuts.
2. Install two Torx bolts holding the rear seat frame to the floor.
3. Install the driver side kick panel and the hood release handle cover.
4. Install the passenger side kick panel (do not install the fuses, fuse panel cover, or kick panel cover).
5. Install two scuff plates on the cab floor.



L. Install the *kit* steering extension

1. Position the *kit* steering extension on the steering wheel shaft. Tighten the *kit* bolt (3/8"-24 x 1 1/4" socket head) to 33 lb-ft.

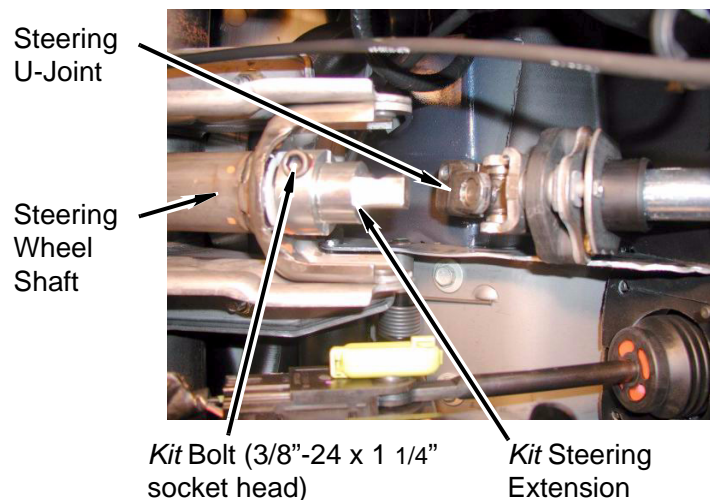

2. Slide the steering U-joint onto the *kit* steering extension.
3. Ensure the steering wheel has not turned. Tighten the bolt to 33 lb-ft.
4. If equipped with adjustable pedals, operate the brake pedal button to ensure there is no interference with the steering U-joint or solenoid. If interference exists, slightly bend the brake pedal sideways.

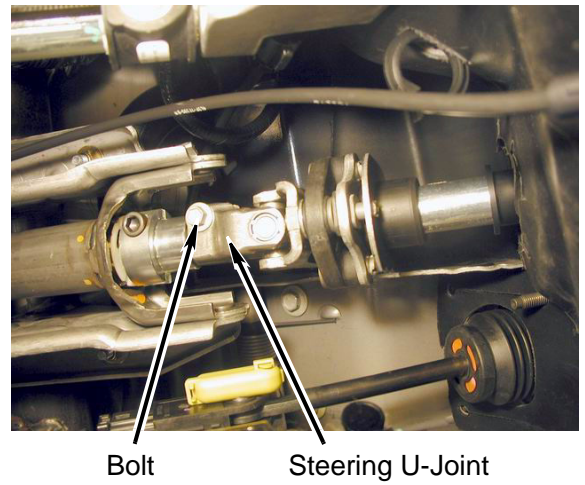

Bolt Steering U-Joint

M. Install the *kit* components under the hood

1. ABS brake controller bracket
 - a. Install the *kit* bracket ("J"-bend) on top of the frame with the bolt.

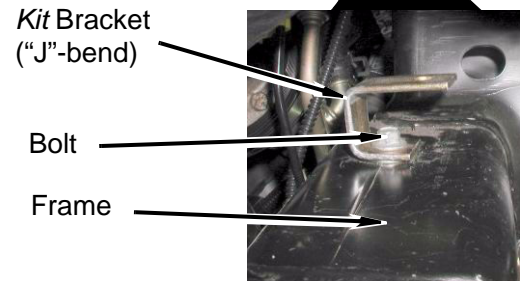

Kit Bracket ("J"-bend)

Bolt

Frame

- b. Install two *kit* brackets ("S"-bend and "S"-bend with stud) on the side of the frame with three bolts and three *kit* washers (7/16"). The *kit* washers must be installed between the *kit* brackets and the frame in order to offset the brackets from the frame.

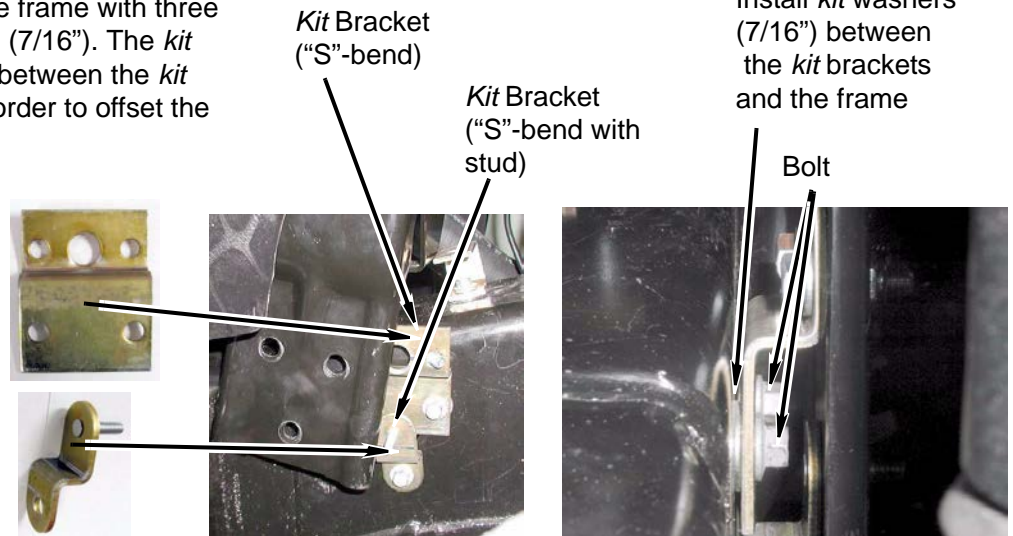

Kit Bracket ("S"-bend)

Kit Bracket ("S"-bend with stud)

Install *kit* washers (7/16") between the *kit* brackets and the frame

Bolt

- c. Insert two *kit* bolts (7/16" x 1") with two *kit* washers (7/16") through the holes in the *kit* bracket ("S"-bend).

Kit Bolt (7/16" x 1"),
Washer (7/16")

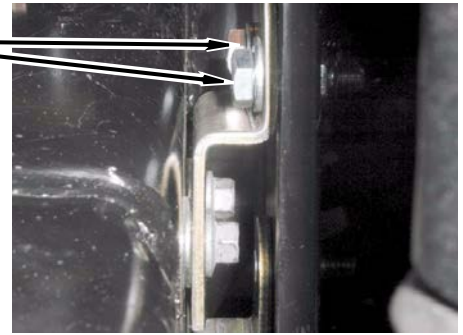

- d. Install the ABS brake controller/bracket assembly on the three installed *kit* brackets:

"J"-bend = *kit* bolt (1/4" x 1"), *kit* washer (1/4"), and *kit* nut (1/4" Nylock).

"S"-bend = two *kit* washers (7/16") and *kit* nuts (7/16" Nylock)

"S"-bend with stud = one *kit* washer (1/4") and *kit* nut (1/4" Nylock)

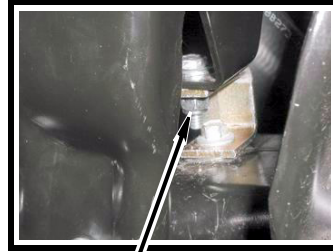

Kit Bolt (1/4" x 1"),
Washer (1/4"),
Nut (1/4" Nylock)

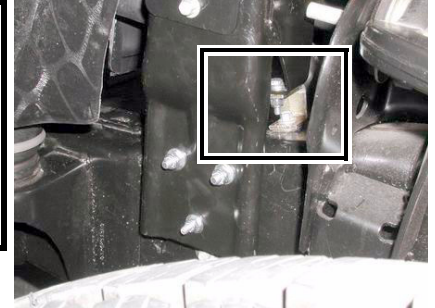

Kit Nut (7/16" Nylock)
Washer (7/16")

Kit Nut (1/4" Nylock)
Washer (1/4")

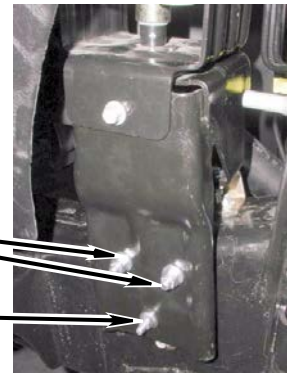

2. Ground strap connection at firewall

- a. Install the *kit* bracket (flat, 3") on the firewall with a bolt.
- b. Install the ground strap on the *kit* bracket with a *kit* nut (1/4" Nylock) and *kit* washer (1/4").

Bolt
Firewall
Kit Bracket (flat, 3")
Kit Nut (1/4" Nylock),
Washer (1/4")
Ground Strap



3. Solenoid valve assembly at firewall

- a. Install two *kit* brackets (flat, 2") on the solenoid valve assembly with two *kit* nuts (1/4" Nylock).
- b. Install the solenoid valve and *kit* brackets on the firewall with two bolts.

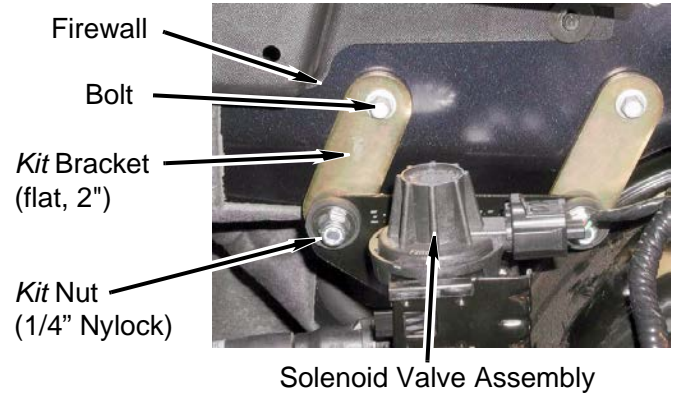

4. Coolant overflow reservoir hose

- a. Install the *kit* pipe (1" x 4") and two *kit* clamps (#20) in the hose between the coolant overflow reservoir and the engine.

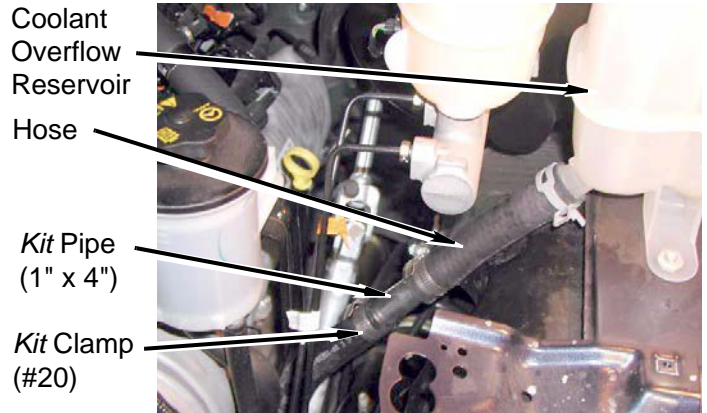

5. Fan shroud modification

- a. Cut two mounting tabs off of the sides of the fan shroud.

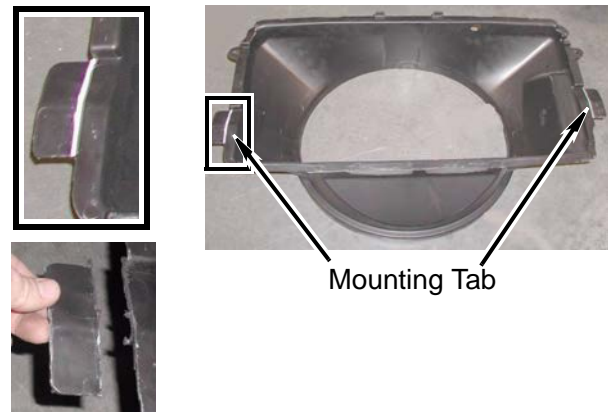

- b. Cut a piece of the flange off of the fan shroud (driver side) to prevent contact between the fan shroud and the components near the bottom of the radiator.

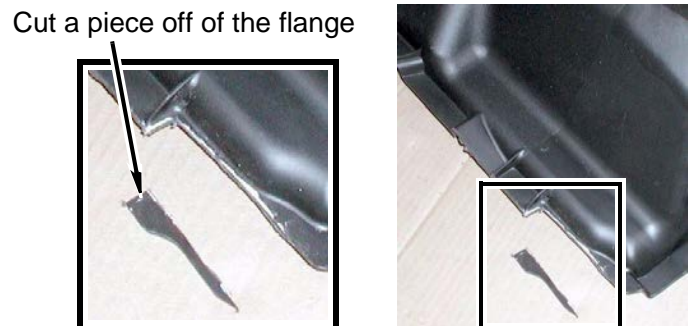

- c. Cut a notch on the passenger side of the fan shroud to prevent contact between the fan shroud and the radiator drain petcock.

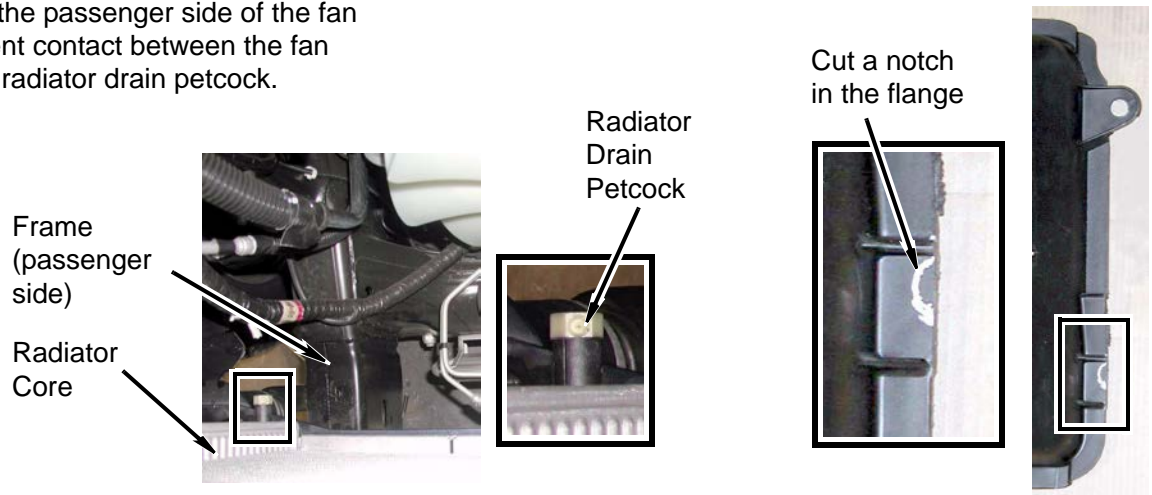

- d. Install two *kit* brackets (flat, 3") on the fan shroud with two *kit* washers (1/4" SAE) and *kit* nuts (1/4" Nylock). Do not tighten. Cut the fan shroud (passenger side, at the upper mounting tab) so the *kit* bracket can be rotated on the *kit* bolt to the vertical position.

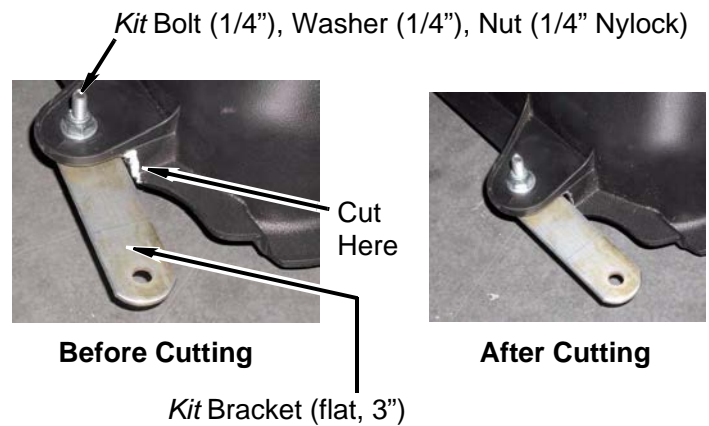

- e. Set the edge of the *kit* gap guard on the top flange of the fan shroud. Align the notch on the *kit* gap guard with the tab on the fan shroud (driver side, upper corner).

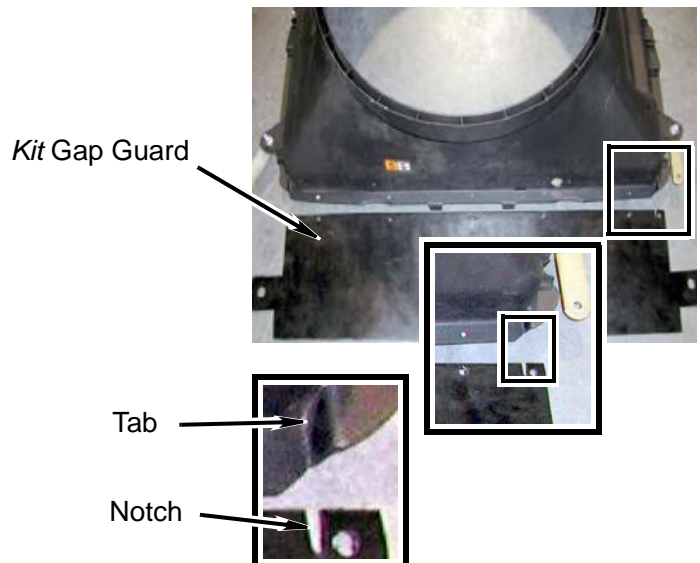

- f. Using the five holes in the *kit* gap guard as a template, mark the flange of the fan shroud. Drill five 1/4" holes in the fan shroud where marked.

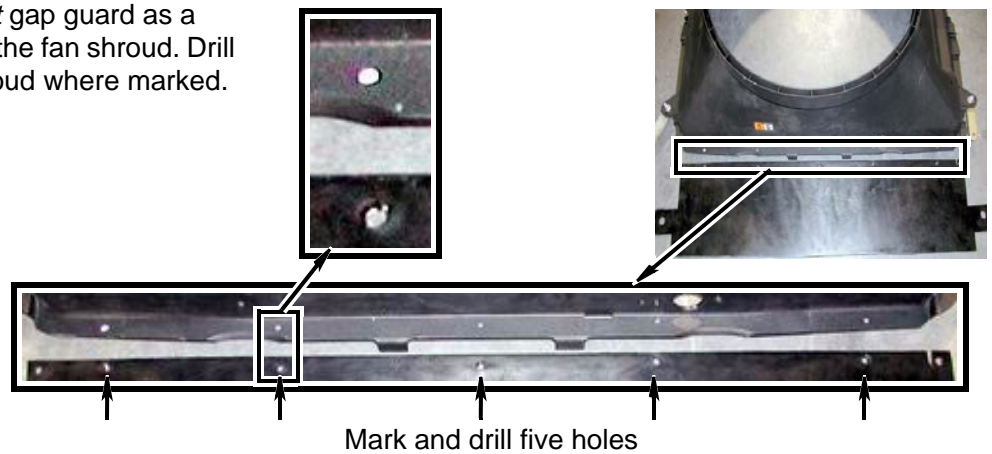

- g. Install the *kit* gap guard on the fan shroud with five *kit* push pins.

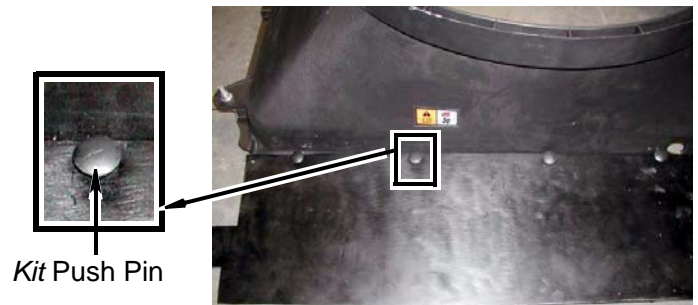

6. Fan shroud installation

- a. Install the fan shroud and *kit* brackets on the radiator with two bolts. Do not tighten.



- b. Place the *kit* gap guard over the radiator pins on both sides of the radiator. Tuck the upper edge of the *kit* gap guard under the lip of the radiator upper support.

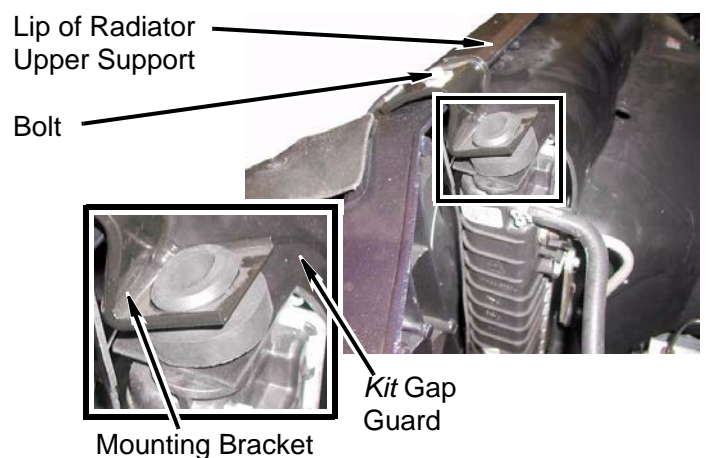

- c. Install two upper radiator mounting brackets (with bushings) on the radiator upper support and radiator with two bolts.

- d. Install the fan on the fan clutch with four bolts.
- e. Position the fan shroud so the fan blades won't contact the fan shroud. Tighten the bolts (*kit brackets-to-radiator*) and *kit nuts* (*kit brackets-to-fan shroud*).

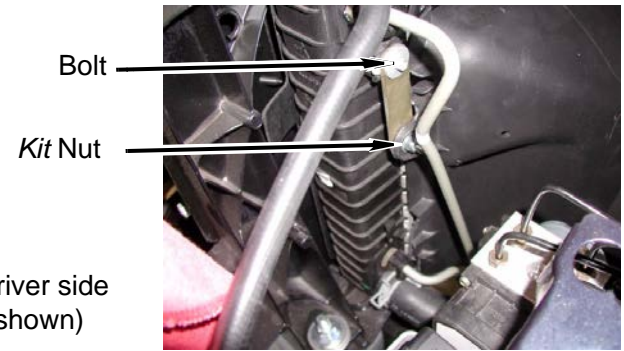

- f. Cut about 1/4" of threaded material off of the *kit bolt* on the driver side to prevent the *kit bolt* from contacting the automatic transmission fluid line.

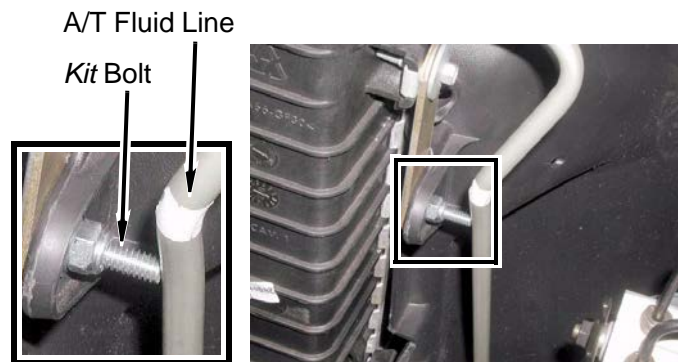

- g. Connect the upper radiator hose to the radiator.
- h. Fill the cooling system.

⚠ CAUTION

After you finish installing the kit, start the engine, wait until the cooling system thermostat opens, completely fill the cooling system, then install the cap on the coolant overflow reservoir.

- 7. Gap closure plate (radiator/fan shroud)
 - a. Assemble the *kit plates* with two *kit bolts* (1/4"), *kit washers* (1/4"), and *kit nuts* (1/4" Nylock).

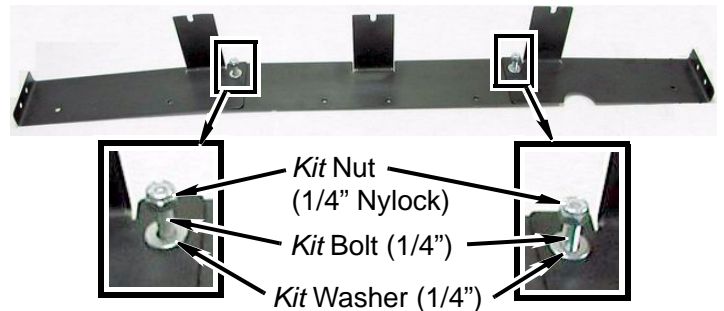

- b. Loosen the bolt at the bottom of the hood latch vertical brace.

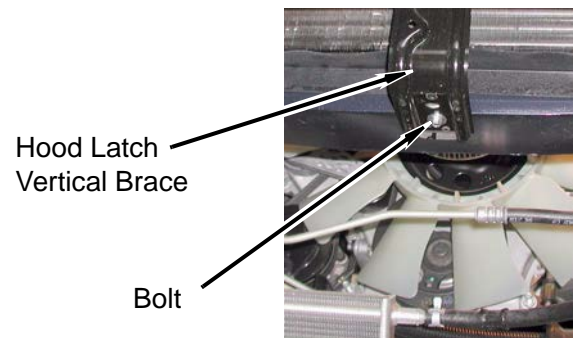

- c. Set the *kit* plate assembly into position under the radiator lower support, guiding the center plate between the lower support and the hood latch vertical brace.

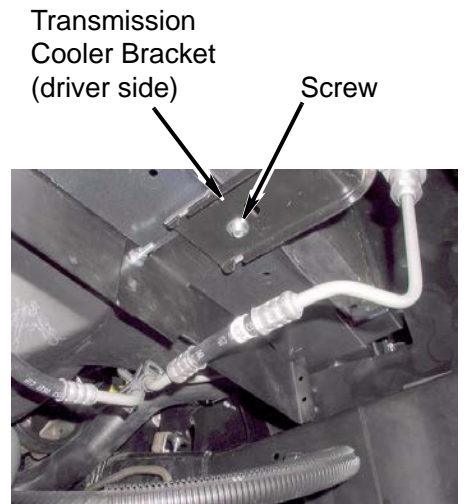
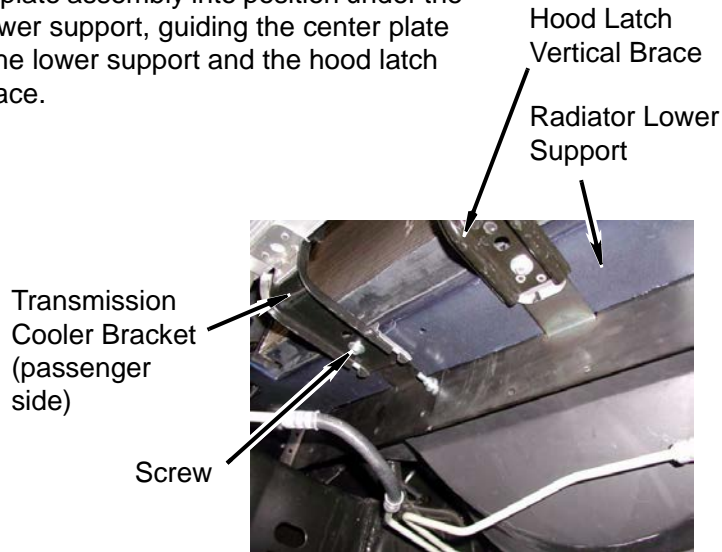

- d. Install the transmission cooler on the lower support with two screws. These screws also secure the *kit* plate assembly to the lower support.
- e. Tighten the bolt at the bottom of the hood latch vertical brace.
- f. Using the plate assembly as a template, drill two 1/4" holes in the fan shroud (one hole below each *kit* bolt). Install a *kit* push pin in each hole.

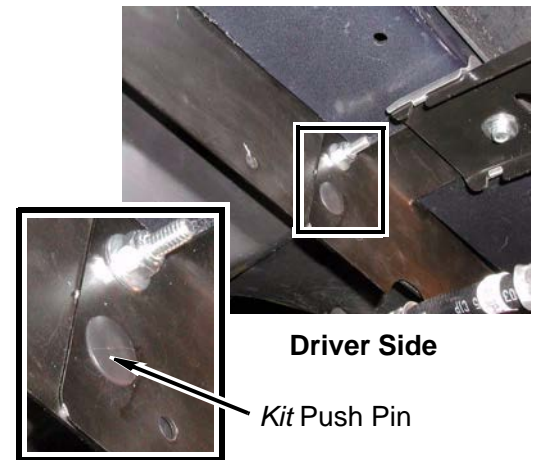
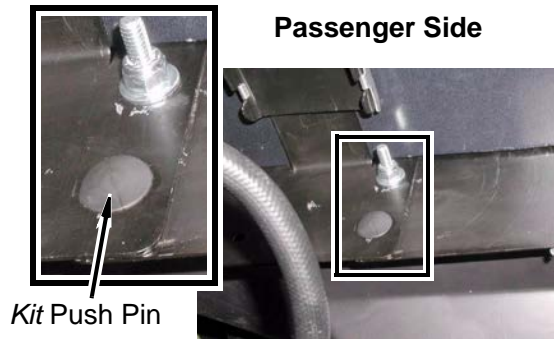

- g. Using the plate assembly as a template, drill seven 1/4" holes in the fan shroud. Install one *kit* bolt (1/4"), two *kit* washers (1/4"), and *kit* nut (1/4" Nylock) in the center hole. Install six *kit* push pins in the other holes.

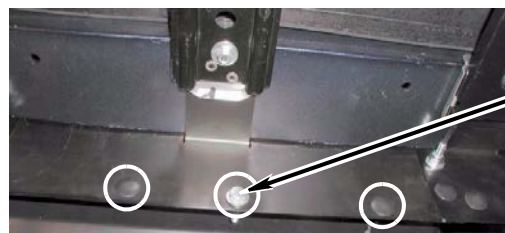
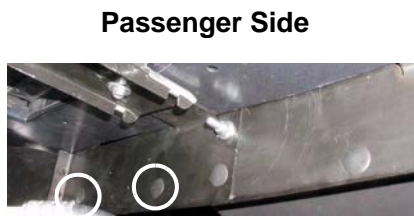

Kit Bolt (1/4"), Washers (1/4"), Nut (1/4" Nylock)

- h. Install a *kit* gap guard at the end of each *kit* plate (driver and passenger side). Use two *kit* push pins to secure the *kit* gap guard to the *kit* plate.

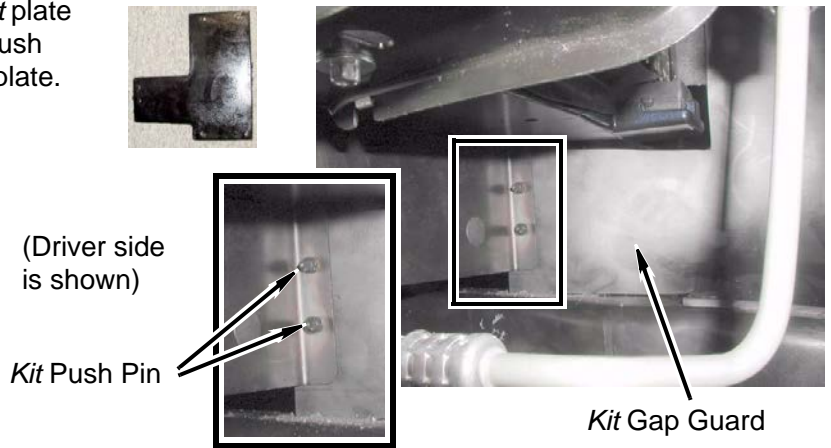

- i. Use two *kit* push pins to secure the *kit* gap guard to the factory shroud on the side of the radiator.

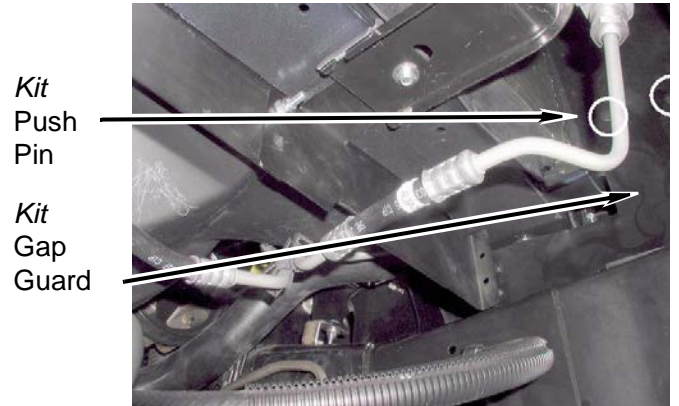

- j. Use two *kit* push pins to secure the *kit* gap guard to the top of the frame.

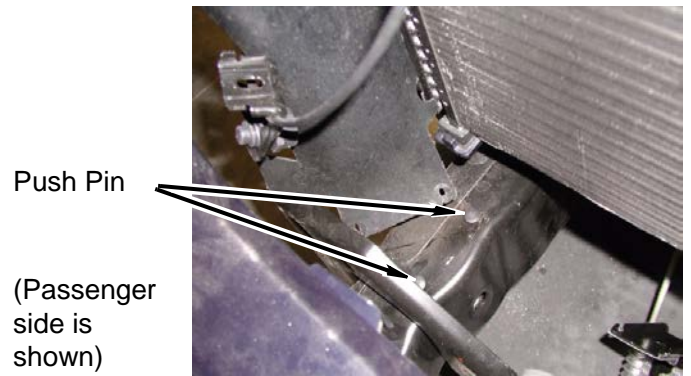

- 8. If necessary, use a *kit* cable tie to secure the battery cable to the A/C line.

- 9. Air intake duct bracket

- a. Mark and cut the air intake duct bracket.

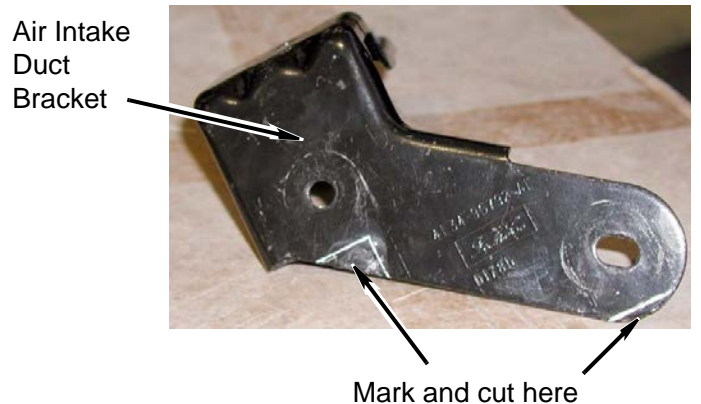

- b. Install two *kit* brackets (flat, 1") on the air intake duct bracket with two *kit* washers (1/4") and kit nuts (1/4" Nylock).

Kit Washer (1/4"),
Nut (1/4" Nylock)

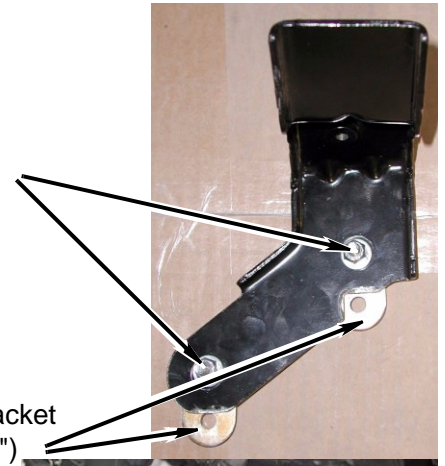

- c. Install the modified air intake duct bracket on the power steering reservoir bracket with two nuts.

Kit Bracket
(flat, 1")

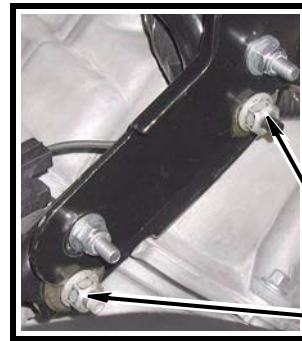

Nut

10. Air intake duct

- a. Attach the air intake duct to the air filter housing, install the duct on the bracket with the bolt, and attach the duct to the driver side inner fender.

Air
Filter
Housing



Air Intake Duct

Bolt

Inner Fender

N. Install the front bumper

1. Mark and cut driver and passenger frame horn as shown.

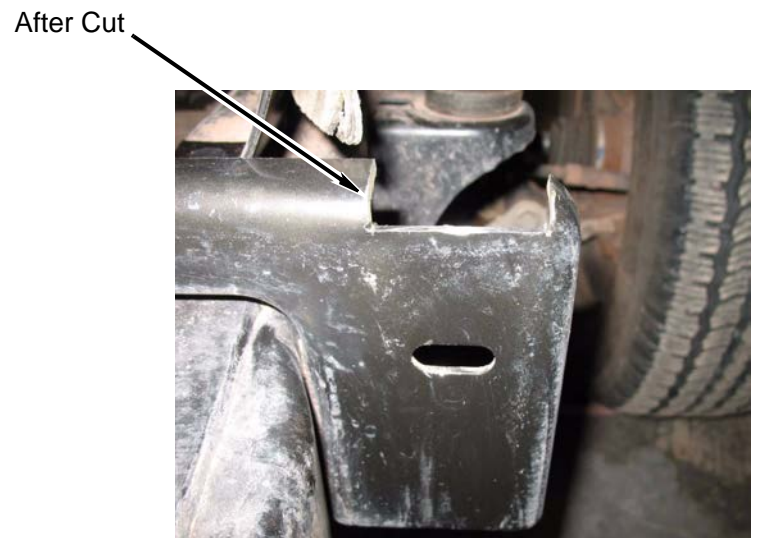
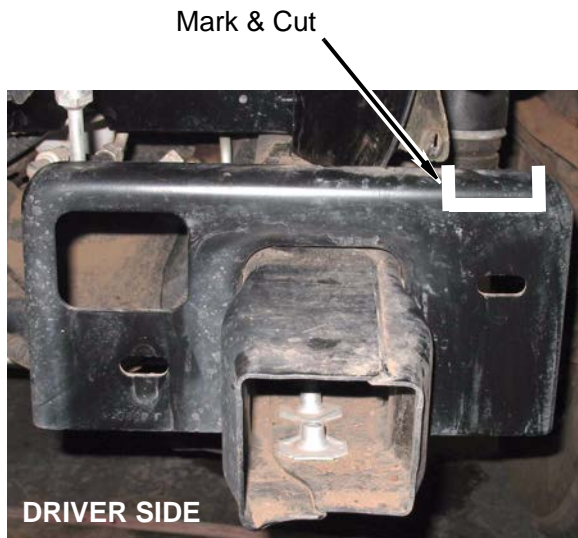

2. Install a *kit* frame plug in the end of each frame horn.



3. Remove four bolts and four retaining clips from two bumper brackets. Remove lower four bumper bracket bolts. Mark and cut driver and passenger bumper bracket as shown.

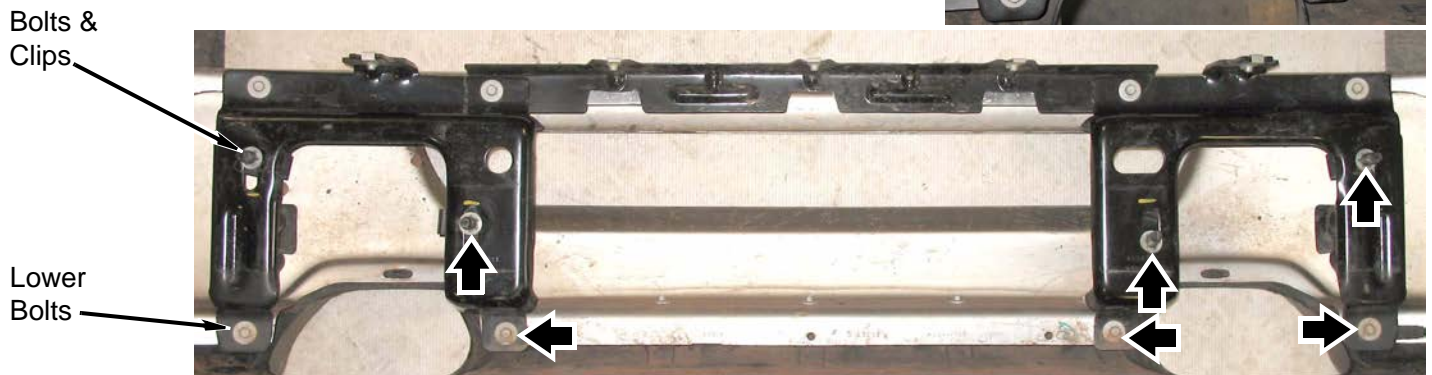
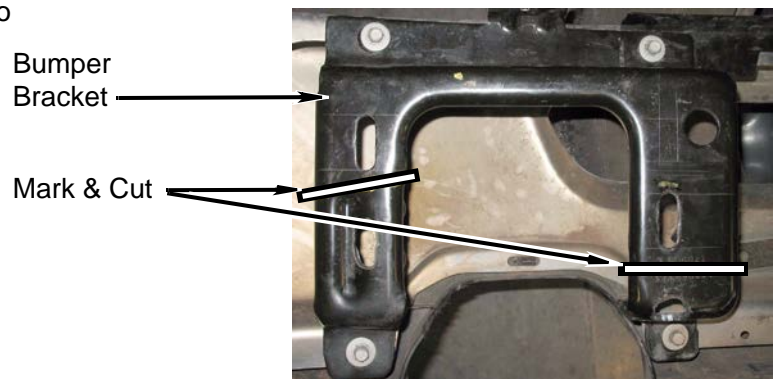

4. Install *kit* brackets (bumper, front, inner) and *kit* brackets (bumper, front, outer) onto bumper brackets with eight *kit* bolts (7/16" x 1"), sixteen *kit* washers (7/16" SAE), eight *kit* nuts (7/16" Nylock) and four O.E. bolts.

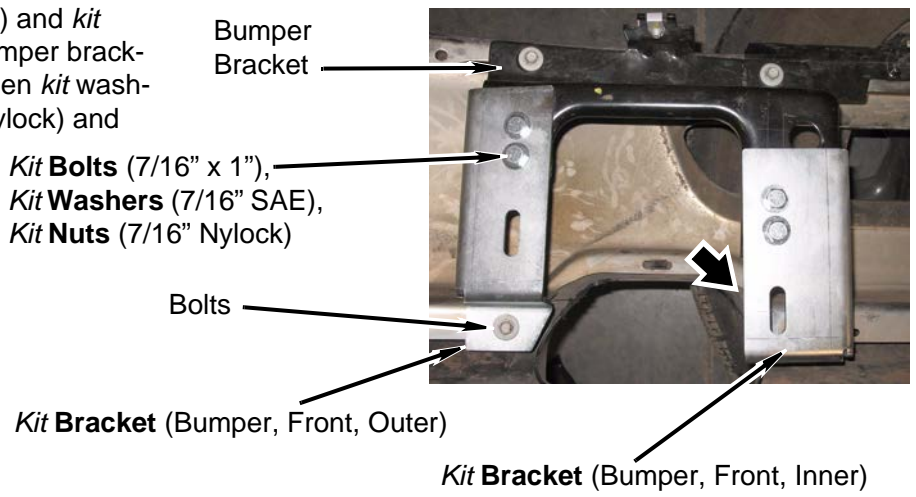

5. Install bumper onto vehicle with four O.E. bolts and nuts. Adjust bumper spacing to previous measurements and TIGHTEN hardware.

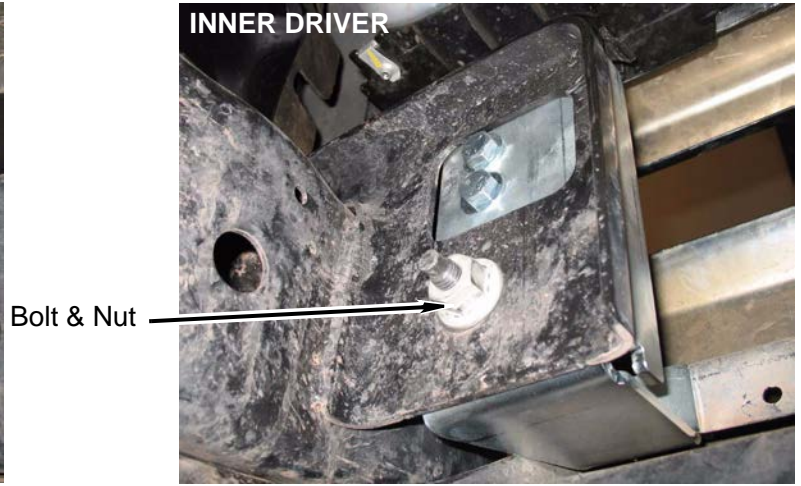
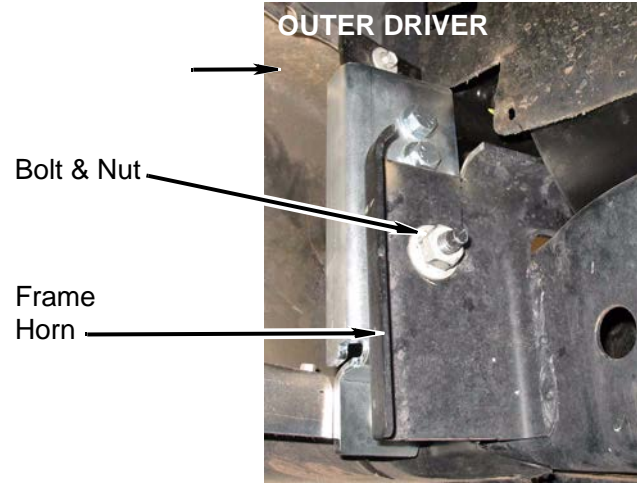

6. **Tow hook models:** Mark and cut lower fascia as shown. Install two tow hooks onto frame with four O.E. bolts.

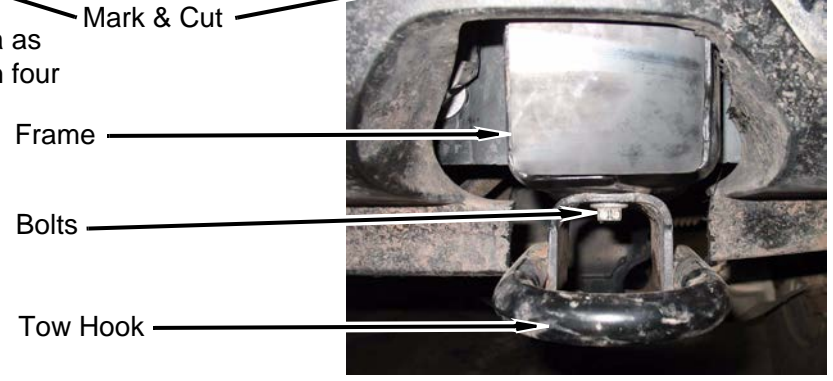

7. Install fascia onto bumper with three bolts.

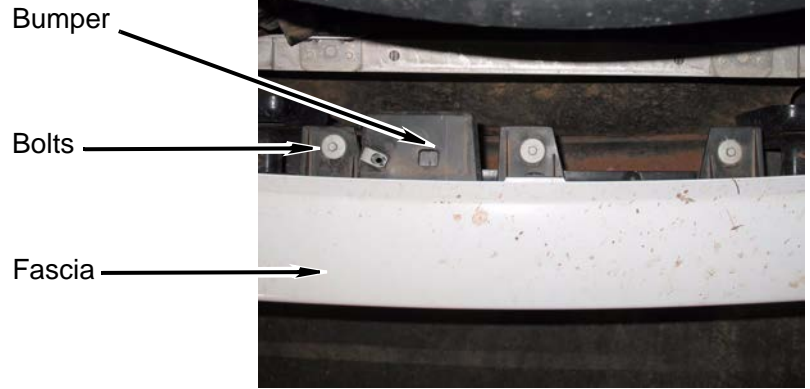

8. Finish installing the front bumper.

a. **(Vehicles with fog lamps)** Connect the wiring harness connectors to the fog lamps.

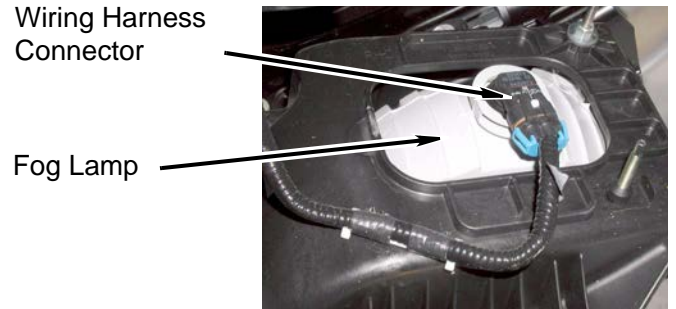

b. Install the air flap on the front bumper and radiator lower support with nine *kit* push pins. If necessary, trim the air flap to prevent contact with the transmission cooler lines or power steering cooler lines.

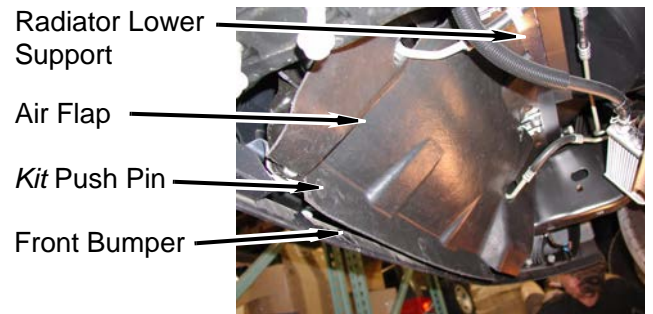

c. Install two grille stops on top of the front bumper with two bolts. Position the grille stops so they are aligned with the white paint marks. If necessary, move the grille stops to ensure the hood closes evenly against the grille stops.

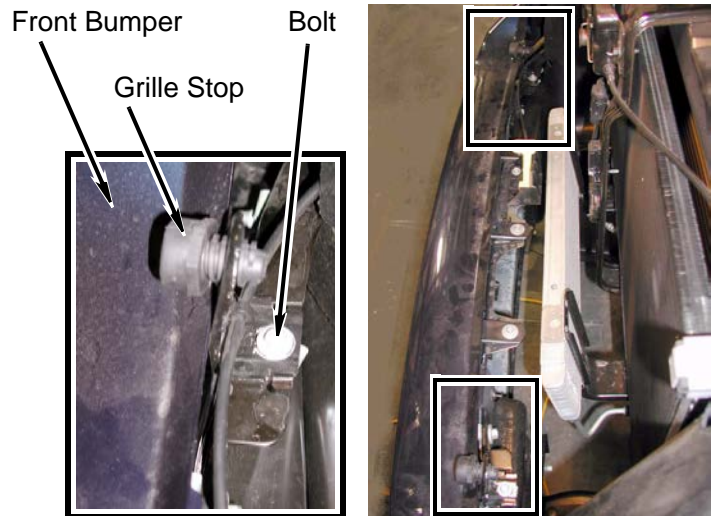

- d. Install the hood release mechanism on the top of the front bumper with one bolt.

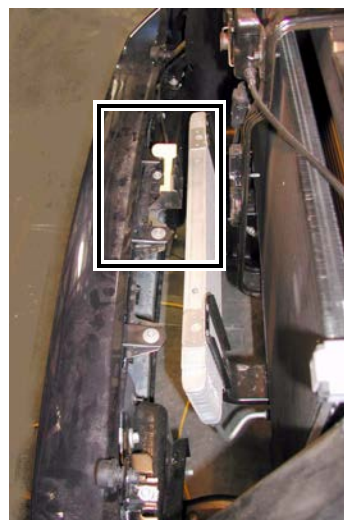
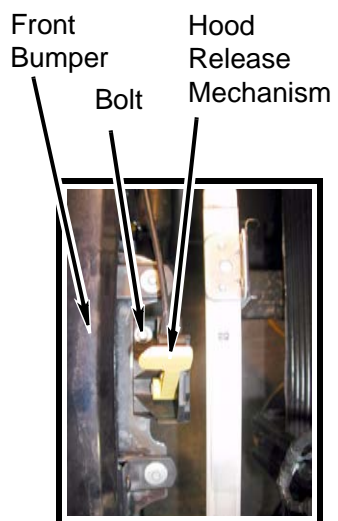

O. After installation is complete

1. Install the airbag fuses in the fuse panel. Install the two fuse panel covers.
2. Connect the positive cable to the battery, then the negative cable.
3. Start the engine, wait until the cooling system thermostat opens, completely fill the cooling system, then install the cap on the coolant overflow reservoir.
4. Apply the *kit* warning label to the dash in plain sight of all vehicle occupants.
5. Double check the vehicle.
 - a. Check all mounting hardware to ensure it is properly tightened.
 - b. Check all wires, hoses, cables, etc. to ensure they have been properly connected and there is ample slack.
 - c. Check the vehicle electrical system.
 - d. Start the engine. Turn the steering wheel all the way to the left and right to ensure no binding occurs.
 - e. Test-drive the vehicle: Check the operation of the clutch. Check the operation of the brake system and the parking brake. Ensure the transmission and transfer case shift properly. Pay close attention to all of the vehicle systems.
 - f. Check all of the hardware again after the vehicle has been driven 500 miles and as part of your regular maintenance schedule.

⚠CAUTION

Performance Accessories does not recommend any particular wheel and tire combinations for use with its body lifts and cannot assume responsibility for the customer's choice of wheels and tires. Reference your owner's manual for recommended tire sizes and warnings related to the use of oversized tires. Larger wheel and tire combinations increase stress and wear on steering and suspension components, which leads to increased maintenance and higher risk for component failure. Larger wheel and tire combinations also alter speedometer calibration, braking effectiveness, center of gravity, and handling characteristics. Consult with an experienced local off road shop to find what wheel and tire combinations work best with your vehicle.

⚠NOTE

All warranty information, instruction sheets, and other documents regarding the installation of this product must be retained by the vehicle owner. Information contained in the instructions and on the warranty card will be required for any warranty claims. The vehicle owner needs to understand the modifications made to his vehicle and how they affect vehicle handling and performance. Failure to provide the customer with this information can result in damage to the vehicle and severe personal injury.

Accessories

Kit# 6742 Gap Guards

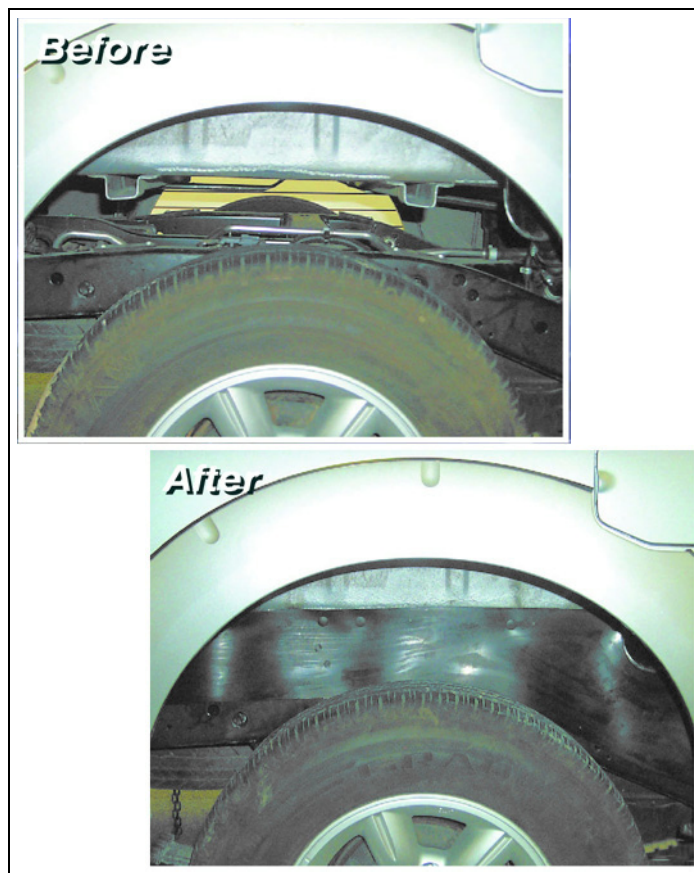

Kit Parts List

Quantity Description

4	Block, bed spacers
4	Block, lift, 3" x 2"
14	Block, lift, 3" x 3"
2	Bolt, 1/2" x 2"
2	Bolt, 1/2" x 10"
4	Bolt, 1/2" x 9 1/2"
6	Bolt, 1/4" x 1"
2	Bolt, 8mm x 100mm
4	Bolt, 10mm - 1.5 x 100mm
8	Bolt, 12mm - 1.75 x 180mm
2	Bolt, 12mm - 1.75 x 220mm
13	Bolt, 3/8" - 13 x 1" (coarse)
1	Bolt, 3/8" - 24 x 1 1/4", socket head
8	Bolt, 5/16" - 18 x 1"
4	Bolt, 7/16"-14 x 1"
1	Bracket, "J" bend
1	Bracket, "S" bend
1	Bracket, "S" bend, with stud (1/4" x 1")
1	Bracket, auto. trans. shift cable
1	Bracket, bumper, front, inner, driver
1	Bracket, bumper, front, inner, passenger
1	Bracket, bumper, front, outer, driver
1	Bracket, bumper, front, outer, passenger
1	Bracket, bumper, rear, driver
1	Bracket, bumper, rear, middle
1	Bracket, bumper, rear, passenger
2	Bracket, flat, 1" (hole-to-hole)
2	Bracket, flat, 2" (hole-to-hole)
3	Bracket, flat, 3" (hole-to-hole)
1	Bracket, parking brake cable
1	Bracket, spare tire mechanism
1	Cable tie
2	Gap guard, lower radiator opening, side
1	Gap guard, upper fan shroud
2	Hose Clamp, #20
2	Hose Clamp, #28
1	Hose, fuel filler extension, 1 3/8" x 2 1/4"
1	Label, logo
1	Label, warning, general
1	Label, warning, rear bumper
1	Loctite
11	Nut, 1/4" - 20, Nylock
8	Nut, 5/16" - 18, Nylock
13	Nut, 3/8", Nylock
4	Nut, 7/16" - 14, Nylock
8	Nut, 1/2", Nylock

Quantity Description

1	Pin, shift extension, 1/2"
1	Pipe, coolant recovery extension, 1" x 4"
1	Pipe, fuel filler extension, 1 1/4" x 2 1/2"
1	Plate, fan shroud block off, lower, center
1	Plate, fan shroud block off, lower, left
1	Plate, fan shroud block off, lower, right
2	Plug, frame horn (front bumper)
25	Push pin, plastic (ratcheting fastener)
1	Steering extension
2	Washer, 8mm
10	Washer, 1/4 SAE
16	Washer, 5/16 SAE
24	Washer, 3/8" SAE
5	Washer, 3/8" USS
23	Washer, 7/16 USS
4	Washer, 1/2" SAE
2	Washer, 1/2" USS
8	Washer, 1 3/8" OD
8	Washer, 1 3/4" OD
8	Washer, 1 3/4" OD, plated