



3651 N. Hwy 89 • Chino Valley, AZ 86323
(928) 636-7080 • www.p-a-g.net

FORD F150 BODY LIFT INSTALLATION INSTRUCTIONS 1997 - 2002 KIT #862 - 863*

*Requires Kit #3700 for manual transmission

⚠WARNING

Installation of a Performance Accessories body lift will change the center of gravity and the handling characteristics of the vehicle. Because of the higher center of gravity and larger tires, the vehicle will handle and react differently both on and off road. You must drive it safely! Extreme care must be taken to prevent vehicle rollover or loss of control, which could result in serious injury or death. Avoid sudden sharp turns or abrupt maneuvers and always make sure all vehicle occupants have their seat belts fastened.

⚠WARNING

Read and understand all instructions, warnings, cautions, and notes in this sheet and in your owners manual before you begin the installation of this body lift kit.

⚠CAUTION

Proper installation of a Performance Accessories body lift kit requires knowledge of the factory recommended procedures for disassembly and assembly of original equipment components. We recommend that the factory shop manual and any special tools necessary to your vehicle be on hand during the installation. Installation of this body lift kit without proper knowledge of the factory recommended procedures may affect the performance of these components and the safety of your vehicle. We strongly recommend that a certified mechanic familiar with the installation of similar components install this body lift kit.

⚠WARNING

This body lift kit should only be installed on vehicles in good working condition. Before installation, the vehicle should be thoroughly inspected for evidence of corrosion or deformation of the sheet metal around the factory body mounts. This body lift kit should not be installed on any vehicle that is suspected to have been in a collision or misused. Off road use of your vehicle with this body lift installed may increase the stress applied to the factory body mounts. We do not recommend that any vehicle with a body lift installed be involved in any extreme off road maneuvers such as jumping. Failure to observe this warning may result in serious personal injury and/or severe damage to your vehicle.

⚠WARNING

Many states now have laws restricting bumper heights and vehicle lifts. Local laws should be consulted to determine if the changes you intend to make to your vehicle comply with state laws.

⚠WARNING

The installation of larger wheel and tire combinations may reduce the effectiveness of the Anti-lock Braking System.

⚠WARNING

Always wear eye protection when operating power tools.

⚠WARNING

Ensure that your vehicle tires are properly blocked and secured before you begin installation of this lift kit.

⚠WARNING

The Supplemental Restraint System (SRS, or air bag) must be deactivated during lift kit installation to avoid accidental air bag deployment while working near SRS sensors and wiring. Do not allow anyone near the air bag during lift kit installation. Accidental deployment can result in serious personal injury or death. Refer to your factory service manual/owner's manual for the recommended procedure to disable the SRS. The SRS must be reactivated before driving the vehicle.

⚠NOTE

Performance Accessories recommends using the Loctite® supplied in the kit on all hardware unless noted in the instructions.

⚠WARNING

DO NOT combine suspension, body, or other lift devices. Use of vehicle with combined lifts may result in unsafe and/or unexpected handling characteristics.

A. Before you start.

⚠NOTE

As you read through this procedure, note that each part referenced has the same callout number throughout. Also, the part number in the text matches the corresponding part number in the art. Kit parts are prefaced by the word *kit* in italics.

⚠NOTE

You will find it easier to keep track of hardware if immediately after removal you put the fasteners for each subassembly in a paper lunch bag and write on the bag where they go.

1. Read all warnings and instructions completely and carefully before you begin.
2. If installing this kit on a manual transmission vehicle it will be necessary to purchase part #3700 shift lever extension. This part is **only** for vehicles equipped with a manual transmission.
3. Check to make sure the kit is complete (refer to the Parts List, section E).
4. Only install this kit on the vehicle for which it is intended. If anytime during the installation you encounter something different from what is outlined in the instructions, call technical support at (928) 636-0979.
5. Park the vehicle on a clean, dry, flat, level surface and block the tires so the vehicle cannot roll in either direction.
6. Disconnect both battery cables. Disconnect the negative cable (1) first, then the positive cable (2) from the battery (3).
7. Remove two covers (4 and 5) and the airbag fuse (6) from the fuse panel (7).

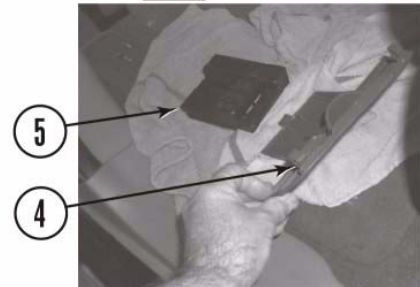
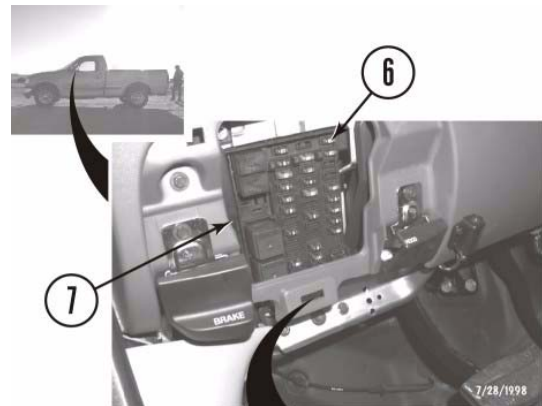
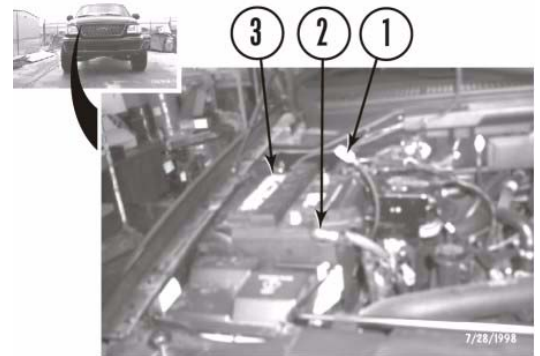

B. Get ready to install the kit.

1. Remove the front bumper.
 - a. Measure distance between the front bumper (8) and front fenders (9). Record measurement.

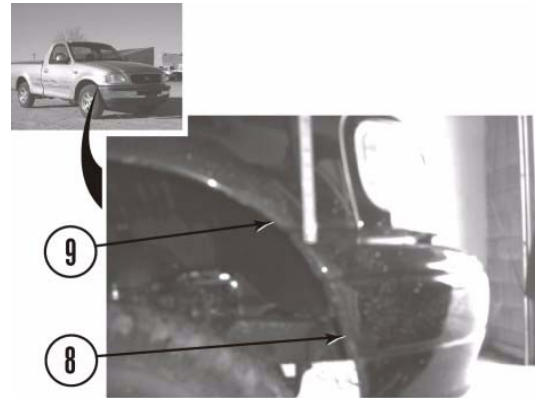

- b. If so equipped, remove two connectors (10) from fog lamps (11).
 - c. Remove eight panel clips (12) and air flap (13) from front bumper (8) and core support (14).
 - d. Remove four nuts (15) and front bumper (8) from frame (16).

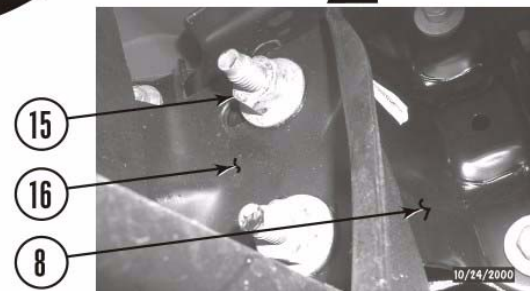
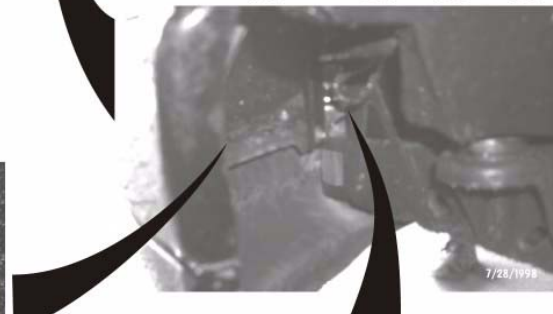
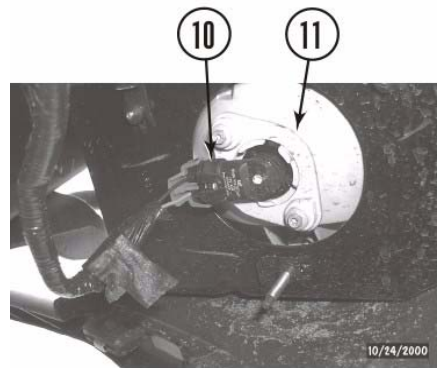
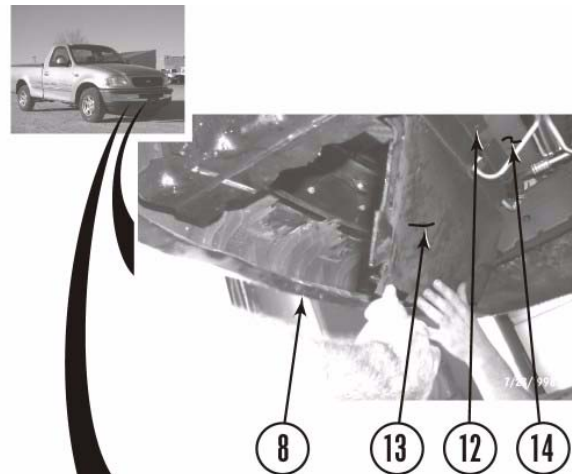

2. Remove the rear bumper.

- a. Disconnect two license plate lights (17) from the rear bumper (18).

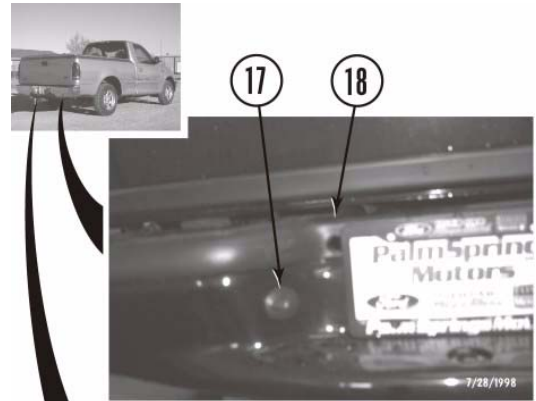

- b. Remove four nuts (19) and rear bumper (18) from frame (16).

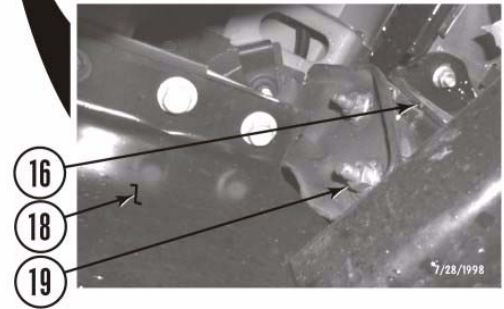

3. Under the hood.

- a. Remove two screws (20) from radiator shroud (21) and fan shroud (22).

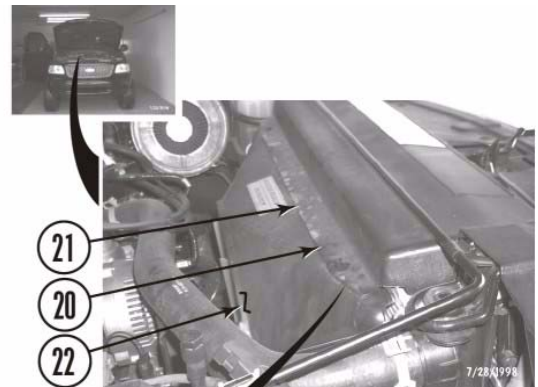

- b. Remove two screws (23) from fan shroud (22) and radiator (24).



- c. Pull radiator shroud (21) up and back from fan shroud (22), off of two top click-in mounting tabs (25). Rest fan shroud on fan.



d. Remove spare tire crank (26) from clips (27).

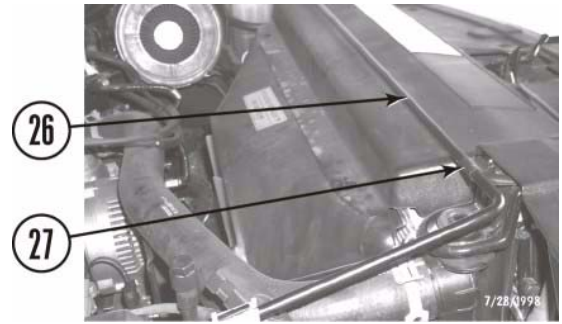

e. Remove seven screws (20) and radiator shroud (21) from core support (14).

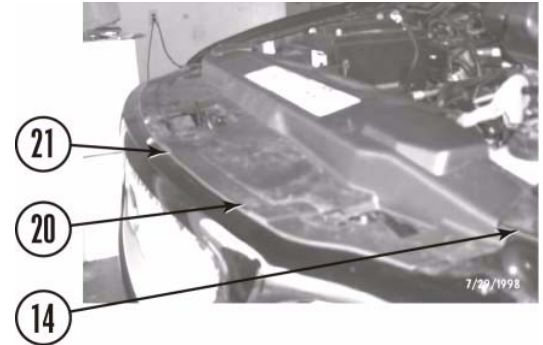

f. Remove three screws with captive washers (28) and fuel injection cover (29) from the throttle body (30).

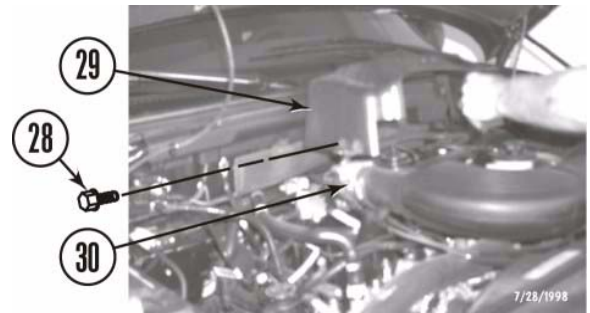

g. Remove clamp (31) from air duct (32) and throttle body (30).

h. Remove two hoses (33) from air duct (32) and throttle body (30).

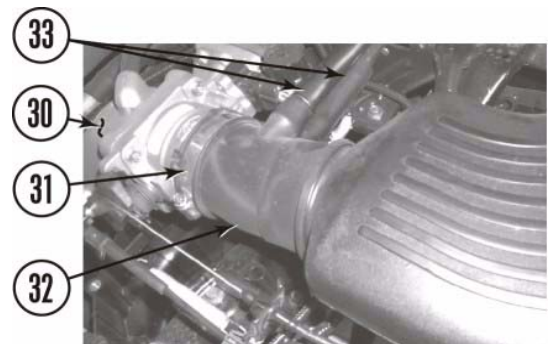

i. Loosen clamp (34) and remove air duct (32) from air filter housing (35). Move air duct out of way.

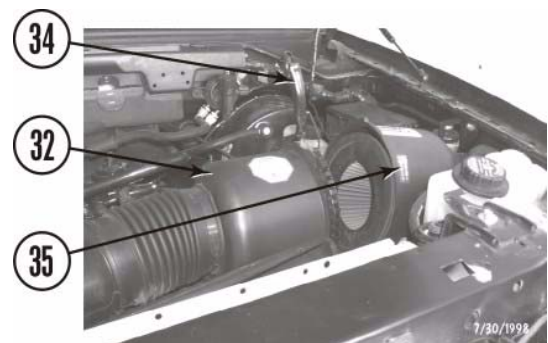

⚠WARNING

Ensure radiator has cooled completely before removing radiator cap. Radiator coolant is **HOT** and **UNDER PRESSURE**. Serious personal injury may result if cap is removed before radiator has cooled.

- j. Remove radiator cap (36) from overflow bottle (37).
- k. Drain radiator (24) into a clean container.

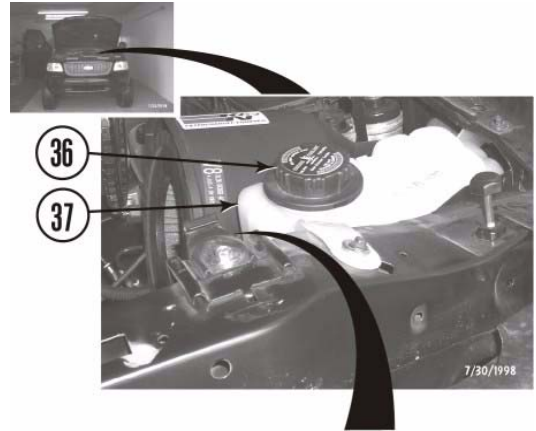

- l. Squeeze clamp (38) and remove hose (39) from radiator (24).
- m. If equipped with automatic transmission, remove two transmission cooling lines (40 and 41).

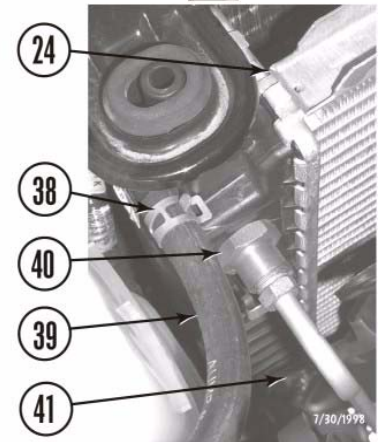

- n. Squeeze two clamps (42 and 43) and remove upper radiator hose (44) and lower radiator hose (45) from radiator (24).

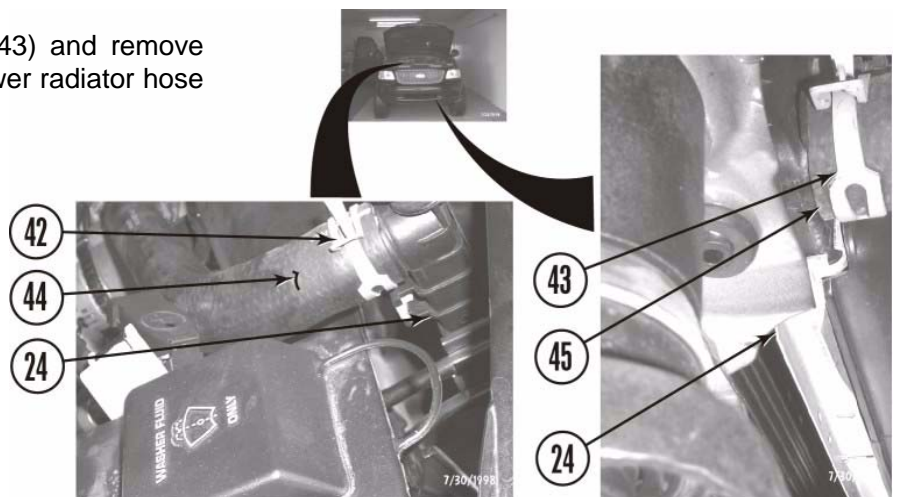

- o. Remove two bolts with captive washers (46), four brackets (47 and 48), and radiator (24) from core support (14). Set radiator aside.
- p. Remove fan shroud (22) from vehicle and set aside.



- q. Remove clip (49) from lines (50 and 51). Clip will not be reused.
- r. Loosen nut (52) from stud (53) so bracket (54) moves freely.

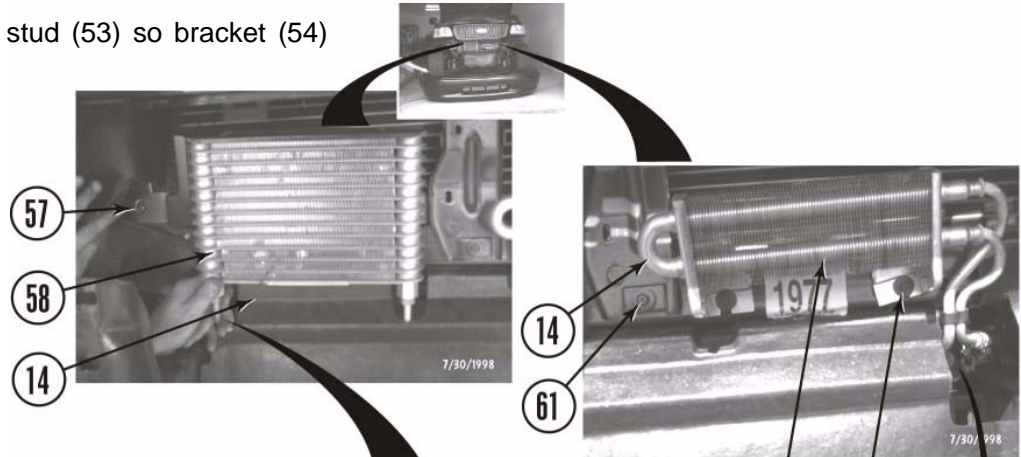

- s. Remove line (55) from clip (56) on frame (16) driver side.
- t. Remove three screws (57) and transmission cooler (58) from the core support (14).
- u. Remove two screws (59) and power steering cooler (60) from the core support (14).
- v. Remove bolt (61) from the core support (14).

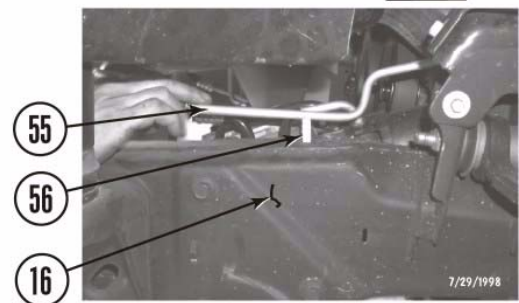
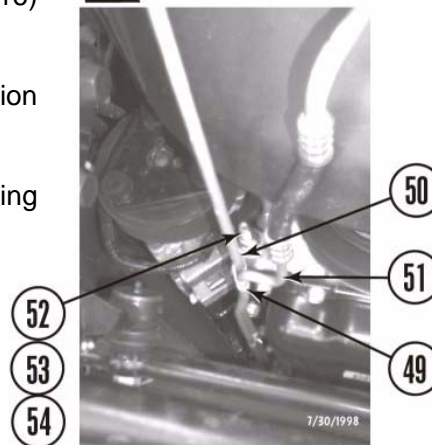

4. Along the frame rails.

- a. Remove line (55) from clip (62) on frame (16) driver side.
- b. Remove clip (63) and line (55) from frame (16) driver side.

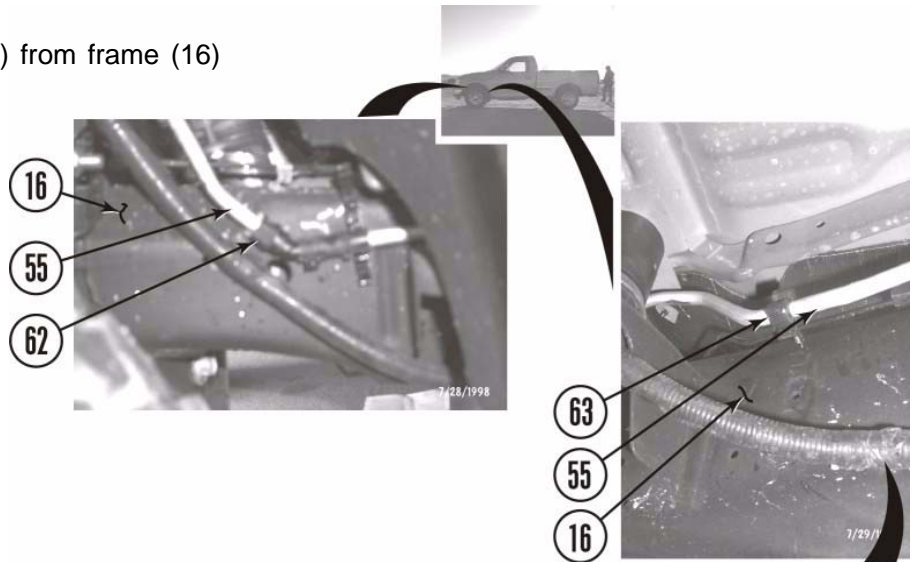

- c. Remove two clips (64) and harness (65) from frame (16) driver side.

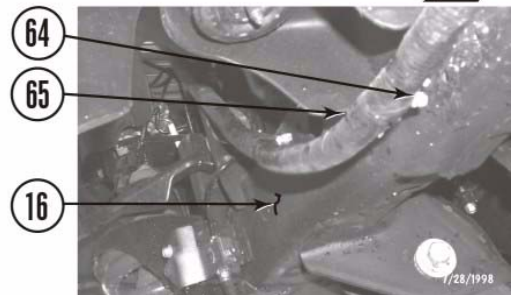

- d. Remove bolt (66) and safety cable (67) from frame (16) driver side.

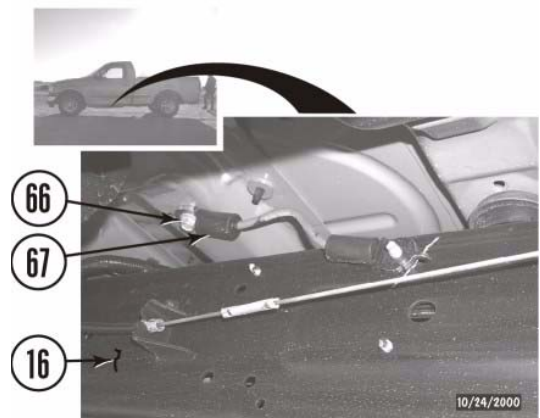

- e. Remove bolt (68) and bracket (69) from frame (16) passenger side.
- f. Remove screw (70) and ground strap (71) from frame (16) passenger side.

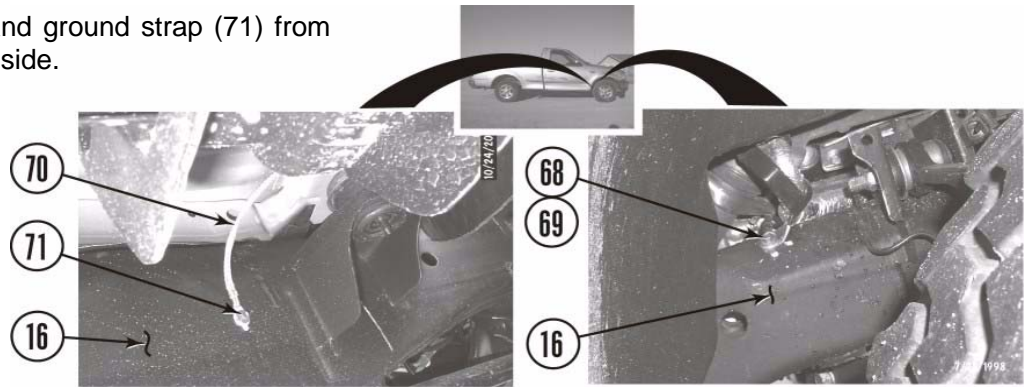

- g. Remove bolt (66) and safety cable (67) from frame (16) passenger side.

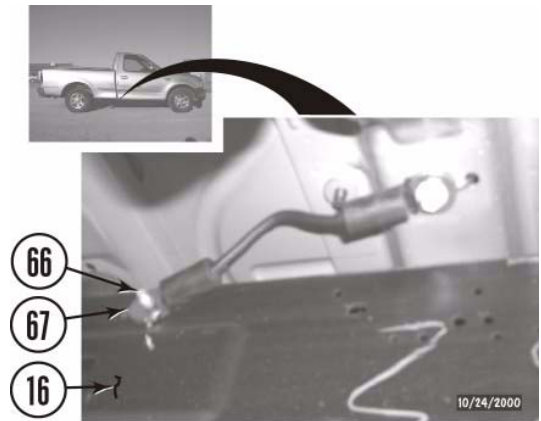

NOTE
 Step 5 is for automatic transmission shown only. Other models skip this step.

- 5. Under the cab.
 - a. Remove two bolts (72) and shift cable bracket (73) from transmission (74).

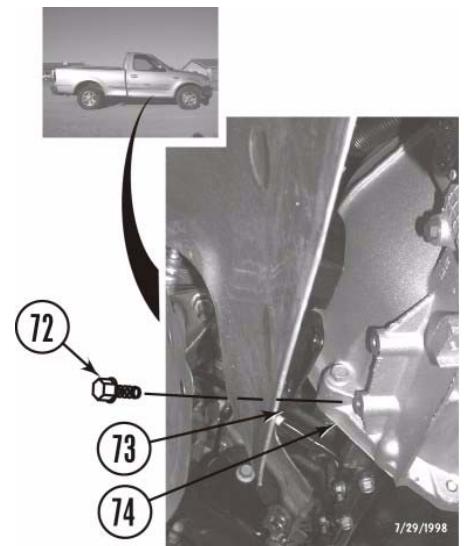

6. Inside the cab.

NOTE

Ensure steering shaft does not turn independently of the steering gearbox. This could cause the air bag system to malfunction, resulting in serious personal injury or damage to the equipment.

- a. Straighten steering wheel and strap the wheel so it will not turn.
- b. Loosen bolt (75) from the steering u-joint (76) under the dash, slide u-joint down to remove from steering wheel shaft (77).

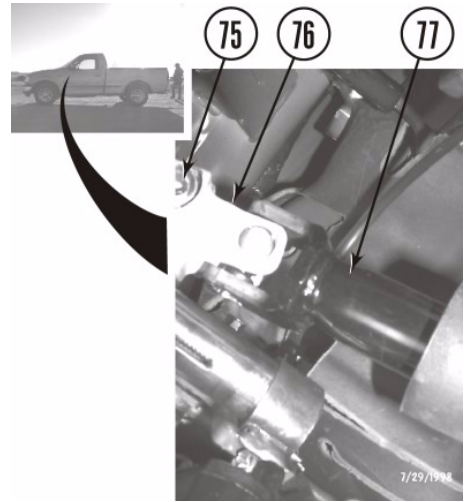

- c. Remove two scuff plates (78) and two kick panels (79) from front of cab floor (80).

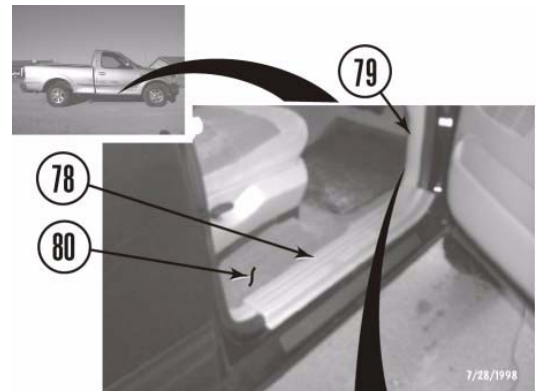

- d. Pull carpet (81) away and remove two rubber caps (82) from front of cab floor (80).

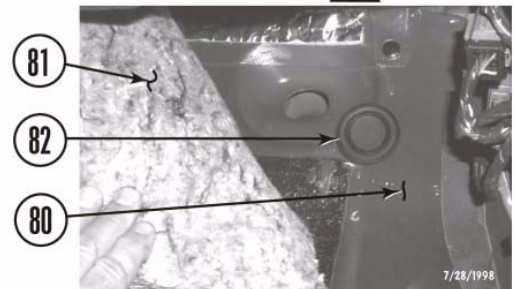

NOTE

Step 6.e and 6.f are for regular cab models only. Other models skip these steps.

- e. Remove three nuts (83) from studs (84) and tray (85) from rear of cab floor (80).
- f. Fold carpet (81) forward and remove two rubber caps (82) from cab floor (80).

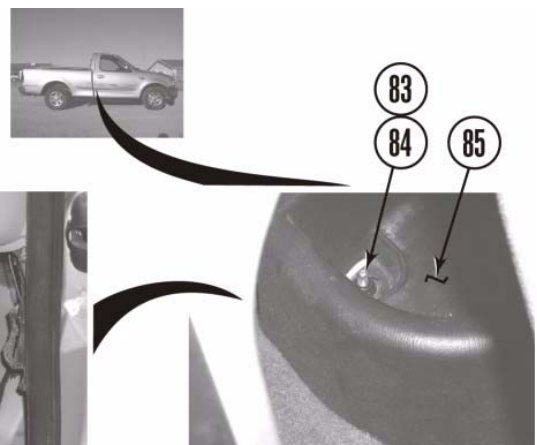

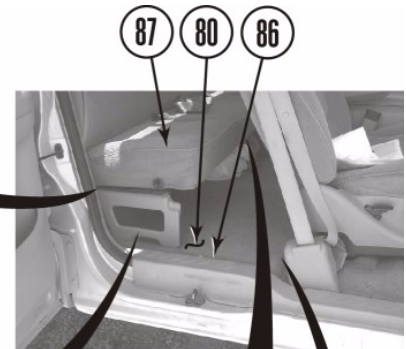

NOTE

Steps 6.g. through 6.k. are for extended cab models only. Other models skip these steps.

- g. Remove two scuff plates (86) from rear of cab floor (80).

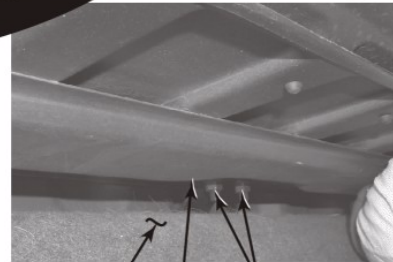
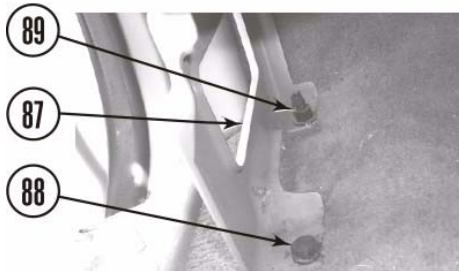

- h. Fold rear seat bottom (87) forward and remove two bolts (88) from rear seat and cab floor (80).
- i. Remove three bolts (88), three nuts (89), and rear seat bottom (87) from studs (90) and cab floor (80).

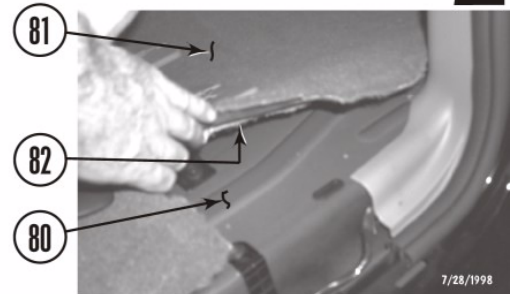

- j. Fold carpet (81) forward and remove two rubber caps (82) from cab floor (80).
- k. Reach under carpet (81) and remove two rubber caps (82) from cab floor (80) just behind front seat. Carpet can be "tented" and caps removed without further carpet removal.

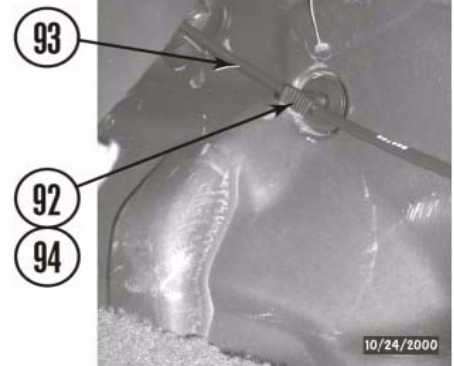

NOTE

Step 6.l. is for automatic transmission/5.4 liter engine usually. Sometimes the 4.6 liter engines have this transmission too and there's no consistency. Sorry.

- l. Remove nut (92) and shift cable (93) from stud (94) under the dash. Cable will slide through floor of cab when cab is lifted.

7. Inside the cab manual transmission.

NOTE

The steps below are for manual transmission vehicles only. To complete the steps below it will be necessary to purchase a shift lever extension part # 3700. Other models skip these steps.

- a. Remove four screws and outer shift boot from floor board. Pull boot up and out of way.

Shift Lever



Screws

Shift Boot

Floor Board



- b. Remove nut from locking bolt.

Nut & Locking Bolt

Shift Lever



- c. Install nut on other side of locking bolt. Tighten nut and remove locking bolt from shift lever.

Nut & Locking Bolt

Shift Lever



Shift Lever



8. Inside the cab manual transfer case.

NOTE

Step 6.n. through 6.p. are for 4wd vehicles only. Other models skip these steps.

- a. Remove four screws (95) and outer shift boot (96) from inner housing (97). Pull boot up and out of way.
- b. Remove four bolts (98) and inner shift boot (99) from cab floor (80). Pull boot up through hole in carpet (81) and out of way.
- c. Remove bolt (100) and transfer case shift lever (101) from linkage (102).
- d. Carefully remove two shift boots (96 and 99) from transfer case shift lever (101).

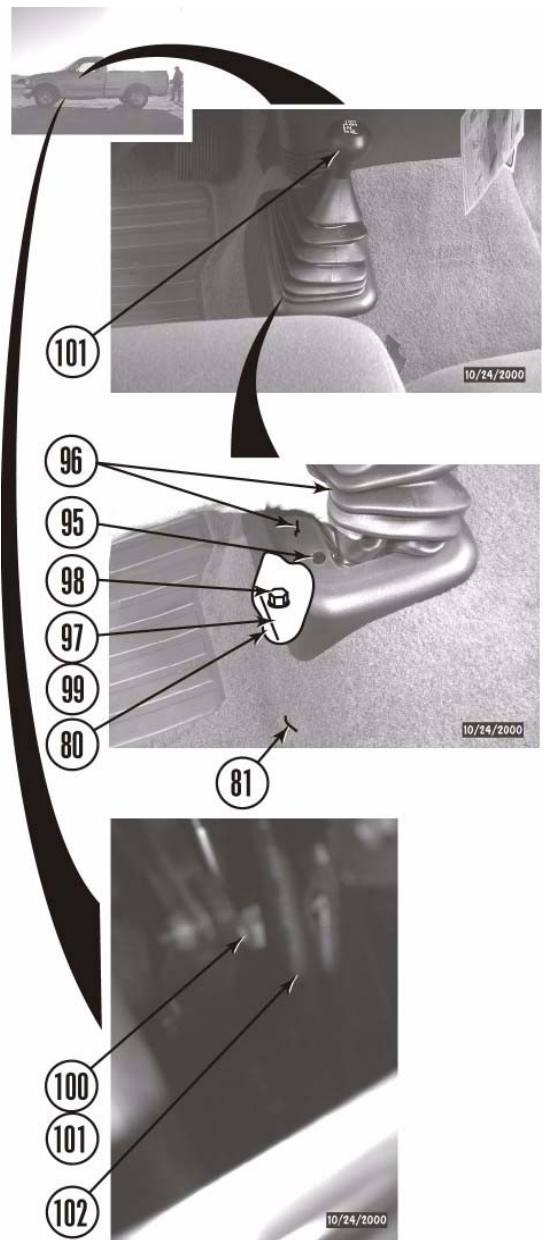

WARNING

Use extreme caution when working near fuel lines and fuel tank. Clean up spilled fuel immediately. Any spark could cause an explosion or fire resulting in serious personal injury and property damage.

9. Remove the fuel filler.

- a. Remove gas cap (102).
- b. Remove three bolts (103) from bed (104) and fuel filler (105).
- c. Remove clamp (106) from fuel filler (105) and tongue (107) and let fuel filler neck drop down from the bed (104).

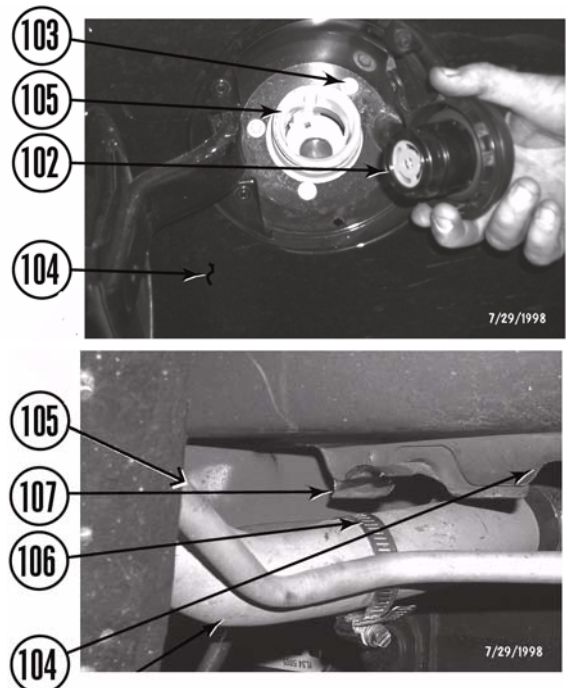

C. Install the kit.

1. Prepare to lift cab from frame.

⚠WARNING

Failure to replace the OEM body mounting hardware (except mounting bolts in the kit) in the stock locations could result in serious personal injury or damage to the vehicle.

- a. Measure distance between the cab (108) and the bed (104). Record measurement for later cab to bed alignment reference in these instructions.

⚠NOTE

Ford uses an extremely cohesive thread locker on cab and bed mounting bolts. This is no problem on the bed and core support mounting points, but the six cab mounting bolts screw into the lower bushings and with the thread locker these are difficult to remove. You will need a friend with a big pair of channel locks to hold the lower bushings while you unscrew the cab mounting bolts. You will encounter much resistance from the thread locker the whole time you are turning the bolts, and air tools really don't work well on this application.

⚠NOTE

You need a large Torx head socket to remove the bed mounting bolts.

- b. Remove six (eight - long bed) bed mounting bolts (109) from bed (104) and frame (16).
- c. Slide bed (104) back from cab (108) approximately 1". Ensure fuel filler (105) does not hang up on bed.
- d. Hold nuts (110) and loosen but do not remove two cab mounting bolts (111) from core support mounting pad (112) and passenger side frame mounting pad (113).
- e. Hold lower bushings (114 and 181) and loosen but do not remove six cab mounting bolts (115, 116, and 117) (see next page for locations).

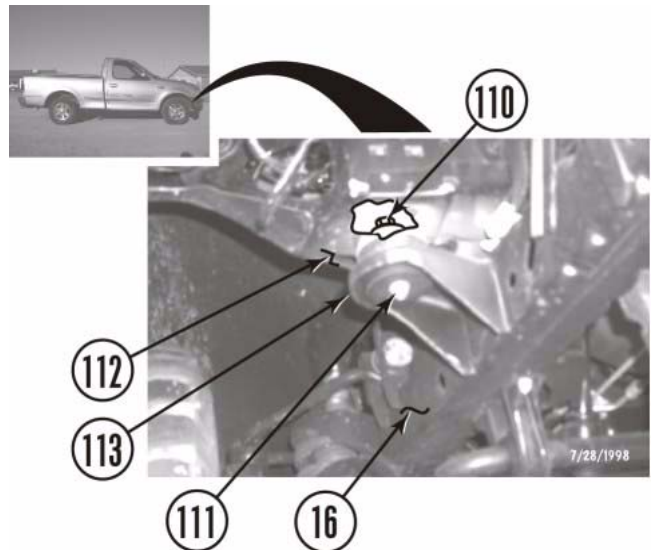
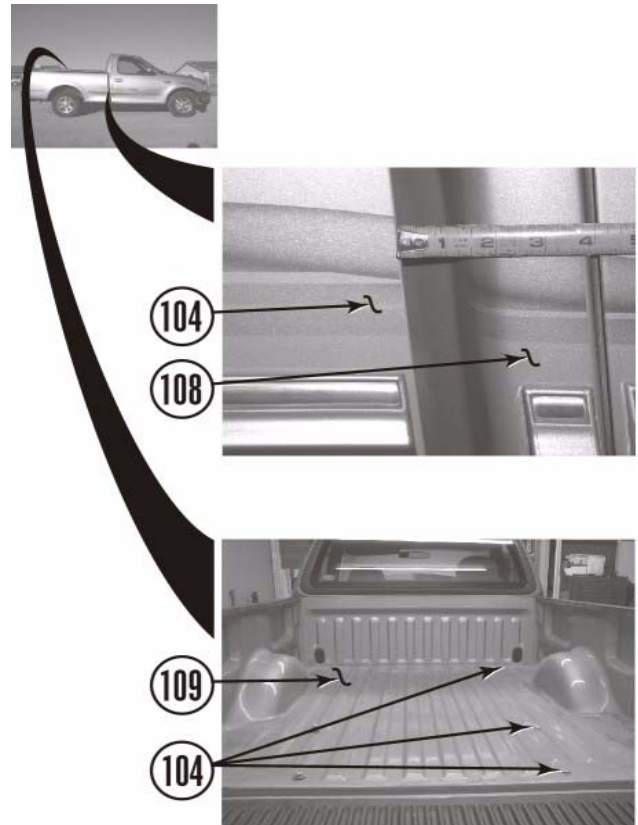

⚠WARNING

Use extreme caution when lifting body from frame. Ensure lifting device is securely placed. Keep hands out from between frame and body, or serious personal injury could result. You may want to lift bed and cab at the same time to avoid damage to cab.

⚠CAUTION

Continually check hoses, wires, lines, etc. to be sure that everything is flexing properly and not binding, or damage to the vehicle could result. Be especially careful of the a/c hoses at the firewall, the belt pulley, and at the core support. Ensure brake lines stretch while lifting. Bending the lines to gain ample slack may be necessary. Be extremely careful not to kink the lines.

⚠NOTE

Ensure stock spacers and body mounting pads stay on vehicle unless otherwise specified in these instructions. *Kit* spacer blocks are installed in addition to the stock spacers and body mounting pads.

- f. Remove bolt with captive washer (111), lower bushing (114), nut (110), and washer (118) from the passenger side core support mounting pad (112) and passenger side frame mounting pad (113).
- g. Remove bolt with captive washer (115) and lower bushing (181) from the passenger side frame mounting pad (113) and cab mounting pad (119).
- h. **Extra cab models only** - Slide ratchet under carpet (81) and remove bolt with captive washer (116) and lower bushing (181) from the passenger side frame mounting pad (113) and cab mounting pad (119).
- i. Remove bolt with captive washer (117) and lower bushing (181) from the passenger side frame mounting pad (113) and cab mounting pad (119).

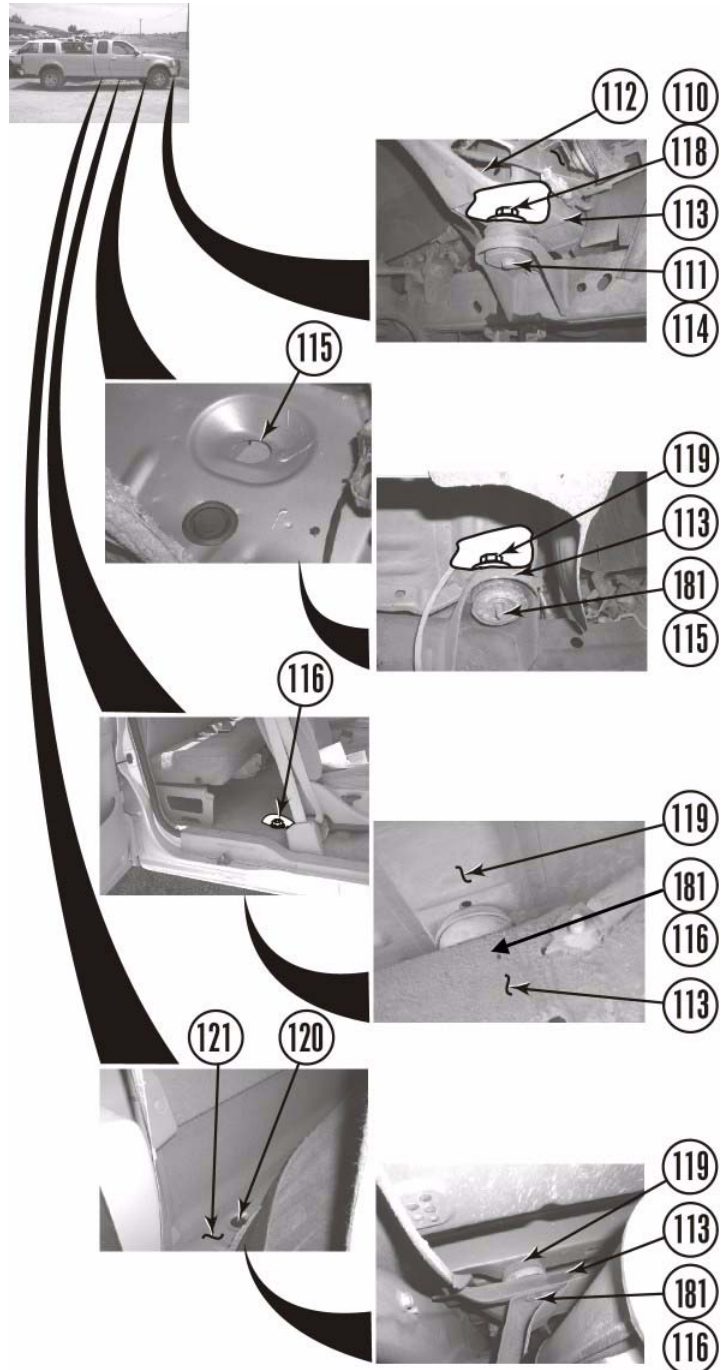

2. Lift cab and install cab passenger side spacer blocks.
 - a. Using a hydraulic jack and a wooden block, slowly lift the cab (108) passenger side just high enough to position the *kit* spacer blocks (120) between the core support mounting pads (112) and frame mounting pads (113).

⚠ CAUTION
ONLY DRILL OUT FRONT CORE SUPPORT UPPER AND LOWER BUSHINGS as directed in the following procedure. Core support mounts are forward most cab mounts. Drilling any other cab mount bushings will not allow for proper installation of kit.

- b. Using a 1/2" drill bit, drill the threads out of the upper and lower core support bushings (114 and 121).
 - c. Position four *kit* spacer blocks (120) on top of the passenger side frame mounting pads (113).
 - d. Install a *kit* 12 x 1.75 x 180mm bolt (122) and *kit* 7/16" USS washer (123) through the lower bushing (181), frame mounting pad (113), upper bushing (180), *kit* spacer block (120), cab passenger side core support mounting pad (112), washer (118) and nut (110). Do not tighten.
 - e. Install a *kit* 12 x 1.75 x 140mm bolt (124) and *kit* 7/16" USS washer (123) through the cab floor (80), *kit* spacer block (120), upper bushing (180), frame mounting pad (113), and lower bushing (181). Do not tighten.
 - f. **Extra cab models only** - Install a *kit* 12 x 1.75 x 140mm bolt (124) and *kit* 7/16" USS washer (123) through the cab floor (80), *kit* spacer block (120), upper bushing (180), frame mounting pad (113), and lower bushing (181). Do not tighten.
 - g. Install a *kit* 12 x 1.75 x 200mm (125) and *kit* 1 3/4" thick washer (126) through the cab floor (80), *kit* spacer block (120), upper bushing (180), frame mounting pad (113), and lower bushing (181). Do not tighten.
 - h. Lower cab (108) on the *kit* spacer blocks (120).
3. Install the cab driver's side spacer blocks.
 - a. Repeat steps C. 1. f. through j. and C. 2. a. through h. for the cab driver's side, ensuring harness (65) (see step B. 4 c.) goes behind spacer block (122) behind wheel well.

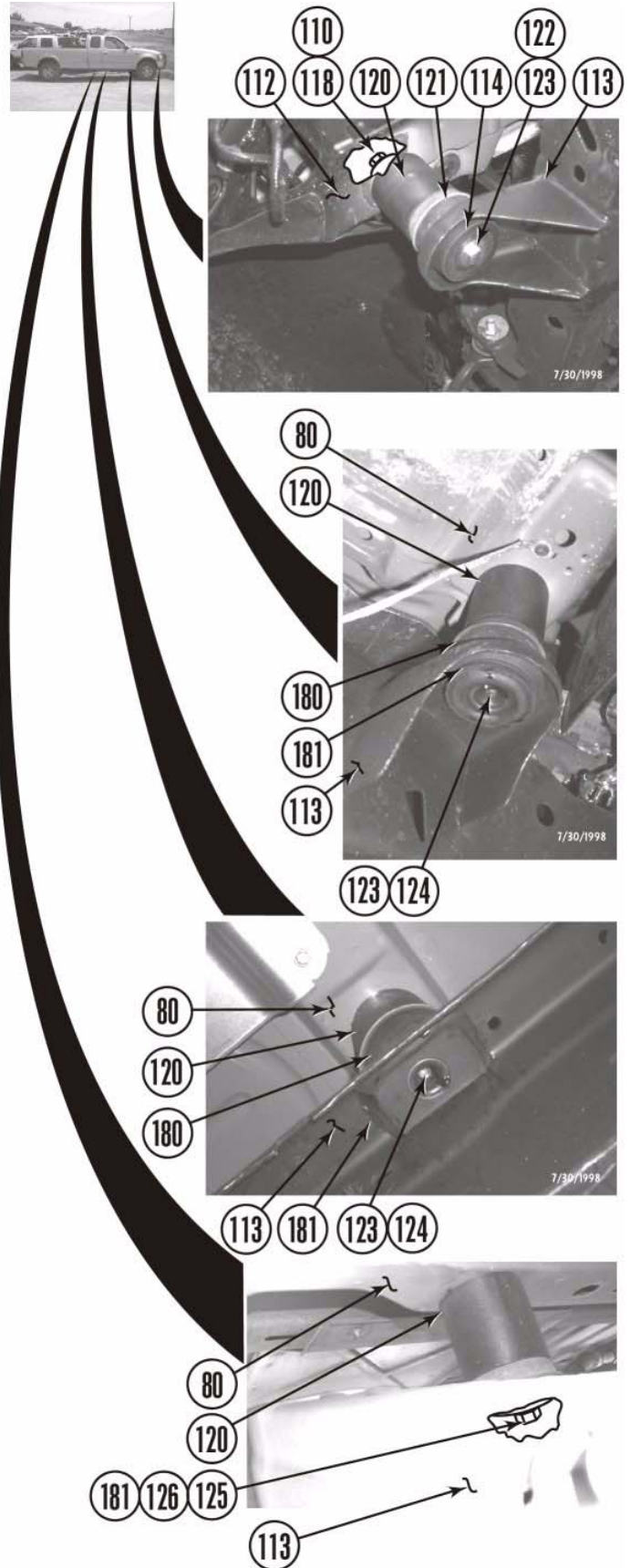

4. Finish the cab spacer block installation.
 - a. Adjust cab to bed clearance using the measurements from step C. 1. a.

- b. Remove eight bolts (122, 124, and 125) one at a time, coat threads with Loctite®, and install. Tighten to 55 lb-ft.

5. Install the bed passenger's side spacer blocks.

- a. Slide the bed (104) back toward the cab (108) approximately 1".
- b. Lift the bed (104) passenger's side just high enough to position three *kit* spacer blocks (120) on the frame mounting pads (113).
- c. Install three (four - long bed) *kit* 12mm x 1.75 x 180mm bolts (127) and *kit* 1 3/4" thick washers (126) through the bed (104), *kit* spacer blocks (120), and the frame mounting pads (113). Do not tighten.
- d. Lower the bed onto the spacer blocks (120).

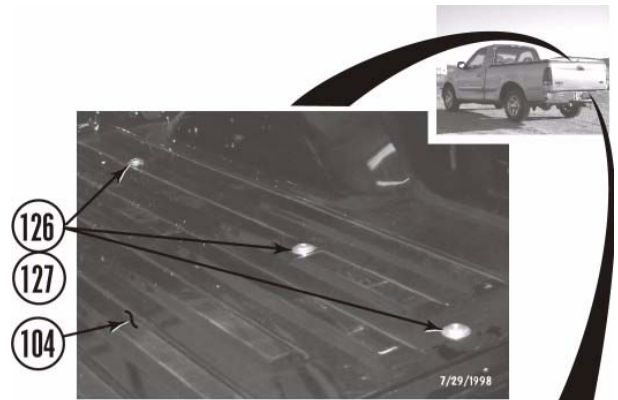

6. Install the bed driver's side spacer blocks.

- a. Repeat steps C. 5 a. through d. for the bed driver's side.

7. Finish the bed spacer block installation.

- a. Adjust the cab to bed clearance using the measurements from step C. 1. a.
- b. Remove six bed mounting bolts (127) one at a time, coat threads with Loctite®, and reinstall. Tighten to 55 lb-ft.

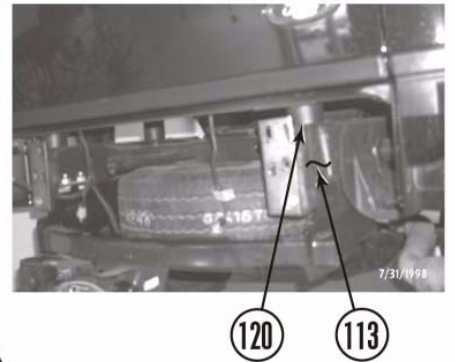

8. Inside the cab.

Install the steering extension.

- a. Position *kit* steering extension (128) in the steering u-joint (76) and tighten bolt (75).
- b. Slide *kit* steering extension (128) up onto steering wheel shaft (77). Ensure steering wheel has not turned and tighten *kit* bolt (129).

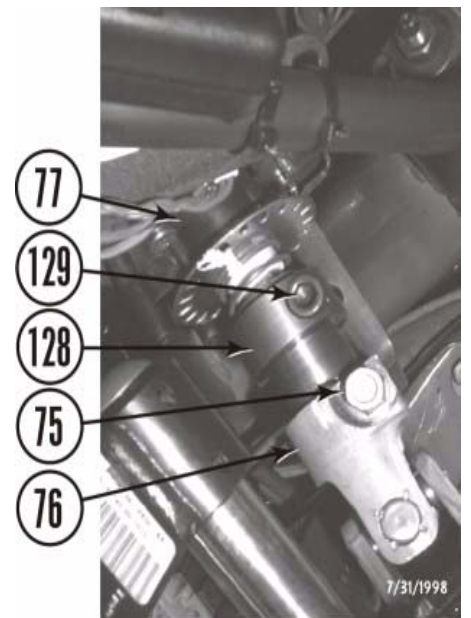

NOTE

Steps 8. c. and d. are for moveable pedal vehicles only. Other models skip these steps.

9. Inside the cab moveable pedals.

- a. Grasp brake pedal (130) and push to the left enough to bend pedal mounting bracket (131) slightly.
- b. Operate pedal button (132). Ensure when brake pedal (130) is all the way forward against firewall pedal does not contact steering u-joint (76) or solenoid (133).

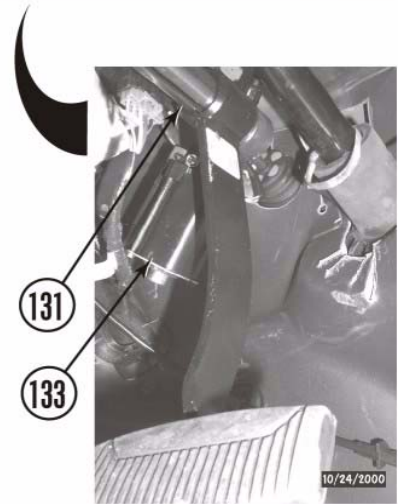

WARNING

Be careful not to damage any of the parts attached to the shift levers during cutting and welding or damage to the equipment could result. A certified welder should perform all welding.

NOTE

Steps 9 e. through h. are for 4wd vehicles only. Other models skip these steps.

10. Inside the cab install the transfer case shift lever.

- a. Scribe a line along the side of the transfer case shift lever (101) (above the bend) as shown. Cut the lever into two pieces through the line and deburr as necessary.
- b. Position *kit* transfer case shift lever extension (134) between the two pieces of the transfer case shift lever (101). Ensure the extension and lever scribed lines align and weld the extension in place.
- c. Slide outer shift boot (96) and inner shift boot (99) on transfer case shift lever (101).
- d. Install transfer case shift lever (101) on linkage (102) with bolt (100). Check transfer case shift lever operation.

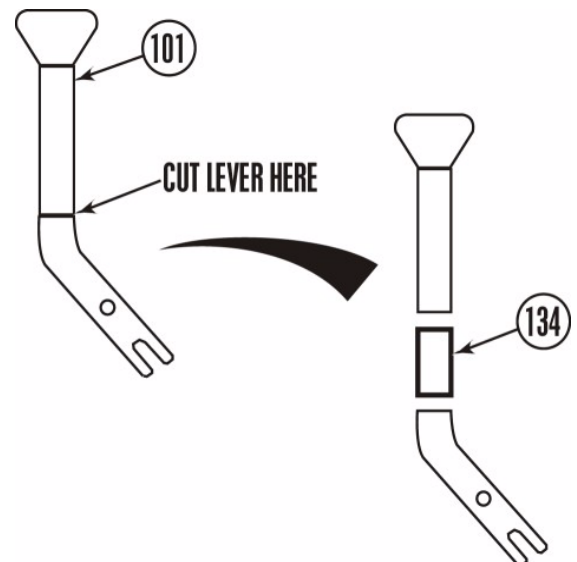

- e. Position inner shift boot (99) through hole in carpet (81) and install on cab floor (80) with four bolts (98).
- f. Install outer shift boot (96) on cab floor (80) with four screws (95).

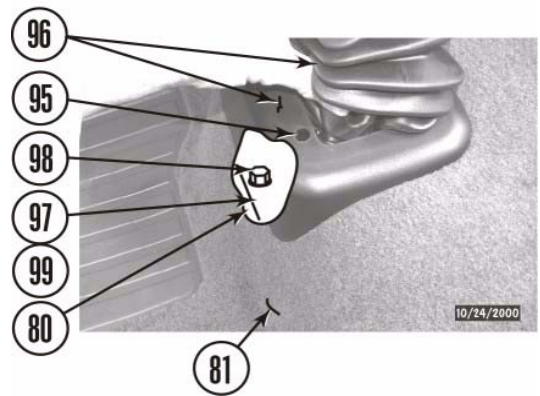
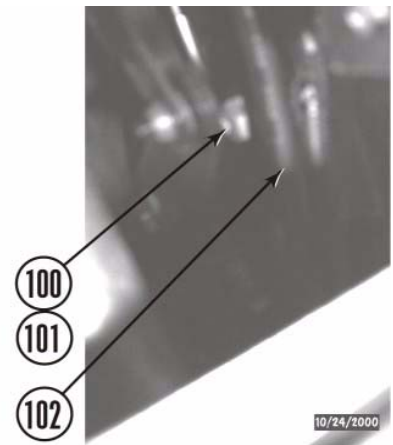

11. Inside the cab manual transmission

NOTE
 Ensure the flat spot on part #3700 matches with the flat spot on the transmission shift lever. Install the roll pin on the proper side to allow alignment of flat spots.

- a. Install kit roll pin in kit shift extension. Do not push all the way in.
- b. Assemble kit bolt and kit nut. Position kit bolt assembly and kit washer on kit shift extension.
- c. Install kit shift extension on transmission shift lever. Tighten bolt down on transmission shift lever flat spot. Using kit nut lock kit bolt in position.
- d. Install shift lever on kit extension with locking bolt and nut.
- e. Install shift boot on floor board with four screws.

Kit Shift Extension

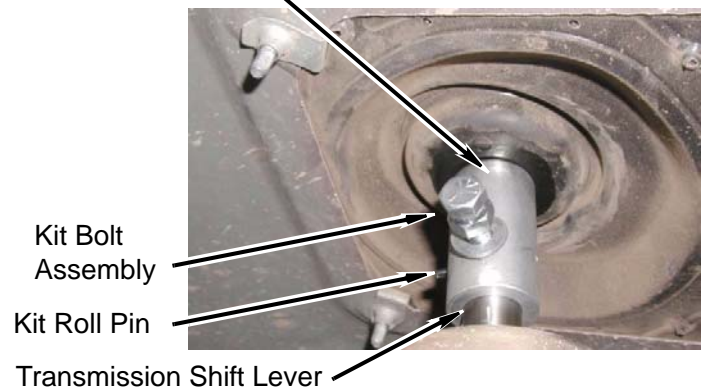

Nut & Locking Bolt



NOTE

Step 10 k. and 10 l. are for regular cab models only. Other models skip these steps.

Install carpet and seat.

- f. Install two rubber caps (82) in rear of cab floor (80) and smooth carpet (81) to it's original position.
- g. Install tray (85) on three studs (84) and rear of cab floor (80) with three nuts (83).

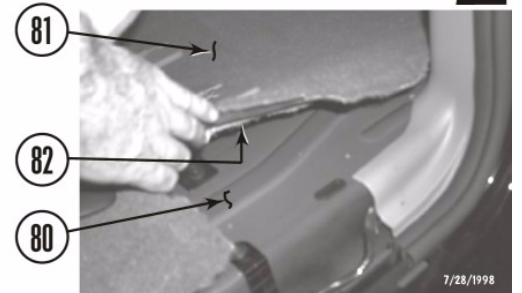
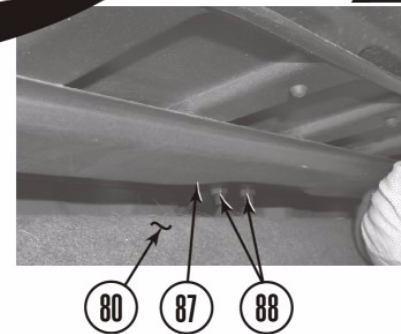
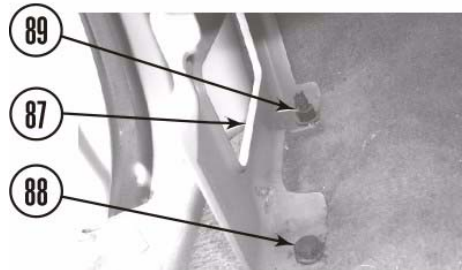
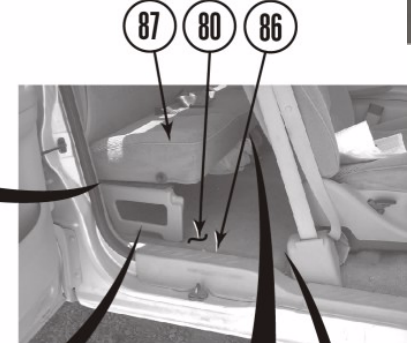
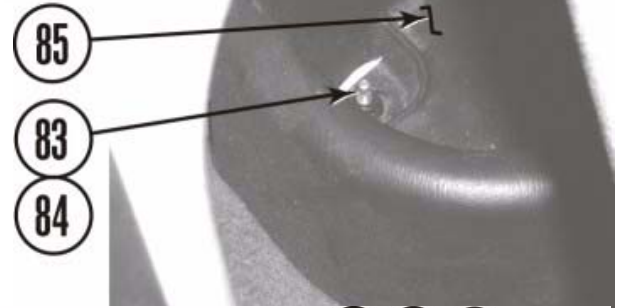

NOTE

Step 8 h. through 8 l. are for extended cab models only. Other models skip these steps.

- h. Install two rubber caps (82) in cab floor (80) just behind front seat.
- i. Install two rubber caps (82) in rear of cab floor (80) and smooth carpet (81) to it's original position.
- j. Install rear seat bottom (87) on studs (90) and cab floor (80) with three bolts (88) and three nuts (89).

- k. Install two bolts (88) in rear seat bottom (87) and cab floor (80). Fold seat bottom back to original position.
- l. Install two scuff plates (86) on rear of cab floor (80).
- m. Install two rubber caps (82) in front of cab floor (80).

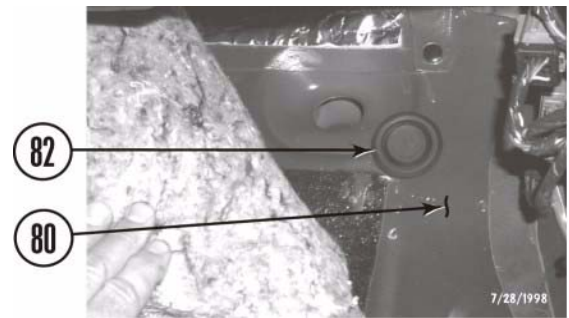

- n. Smooth carpet (81) into corners of cab floor (80) and install two kick panels (79) and two scuff plates (78).

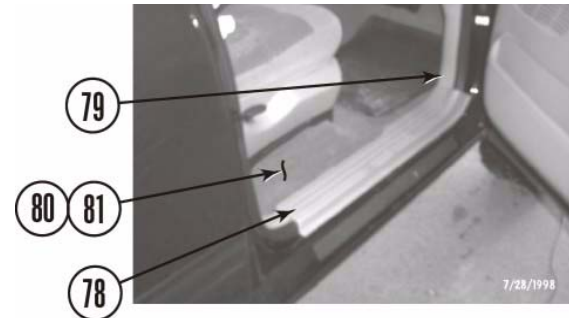

12. Under the cab.

NOTE
 Steps 9. a. through 9. c. are for automatic transmission shown only. Other models skip these steps.

- a. Check the parking brake cable (135) to ensure it slid down through the grommet (136) in the cab floor (80). Ensure grommet is correctly positioned in cab floor.
- b. Install *kit* bracket (137) on transmission (74) with two bolts (72).
- c. Install shift cable bracket (73) on *kit* bracket (137) with two kit 5/16 x 1" bolts (138), four 5/16" SAE washers (139), and two 5/16" nylock nuts (140).
- d. If the transmission shift indicator pointer on the column is now off, adjust it using the wheel (141) under the dash until the pointer points correctly to all shift ranges.

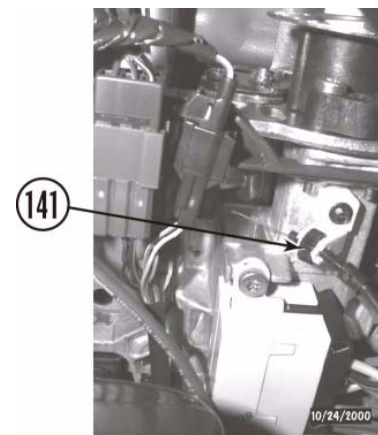
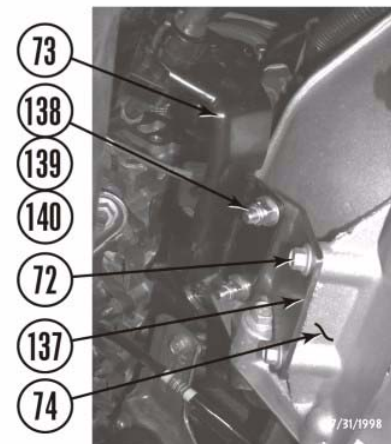
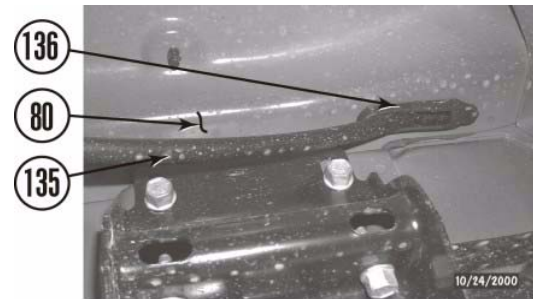

△NOTE

The step below is for automatic transmission models only. Other models skip this step.

- e. Slide nut (92) up shift cable (93) and install on stud (94).

△WARNING

Use extreme caution when working near fuel lines and fuel tank. Clean up spilled fuel immediately. Any spark could cause an explosion or fire resulting in serious personal injury and property damage.

13. Install fuel filler.

- a. Remove two clamps (106 and 142), filler hose (143), and vent hose (144) from gas tank (145).
- b. Remove two clamps (106 and 142) and fuel filler (105) from filler hose (143) and vent hose (144).
- c. Cut filler hose (143) in half as shown.
- d. Install half of filler hose (143), *kit* filler hose extension (146), and other half of filler hose (143) on fuel filler (105) with three *kit* #28 clamps (147).
- e. Install *kit* vent hose (148) on fuel filler (105) with *kit* #10 clamp (149).
- f. Install *kit* vent hose (148) and filler hose (143) on gas tank (145) with two clamps (106 and 142).
- g. Install fuel filler (105) on tongue (107) with clamp (106).

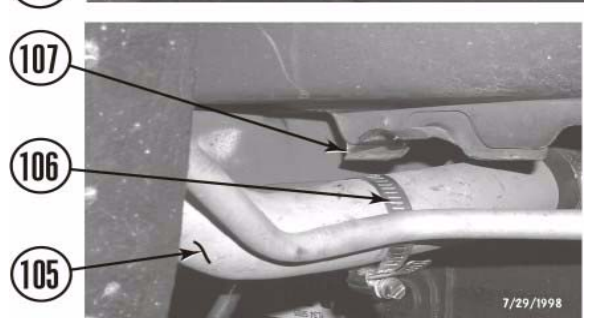
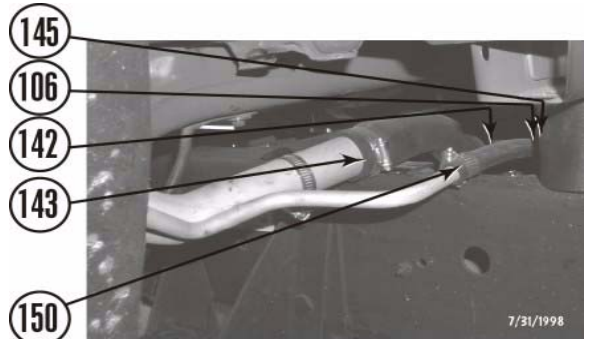
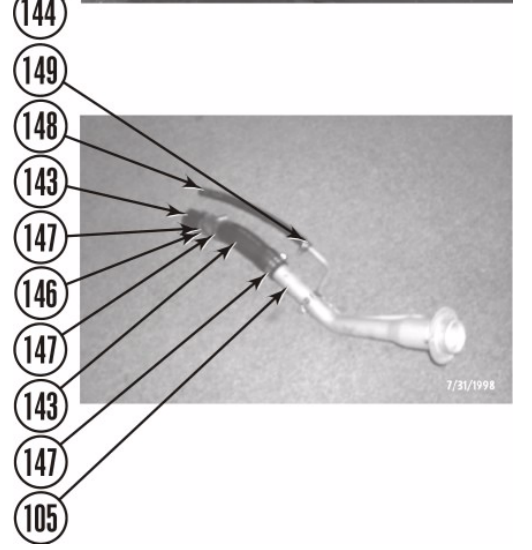
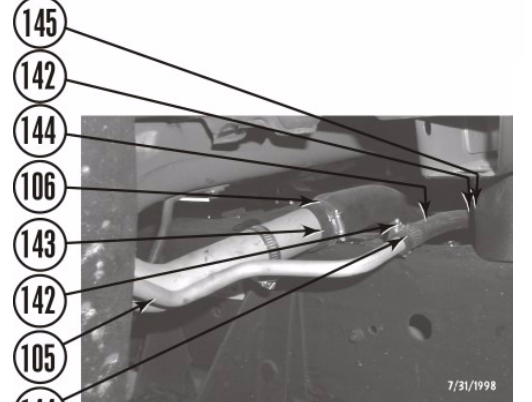
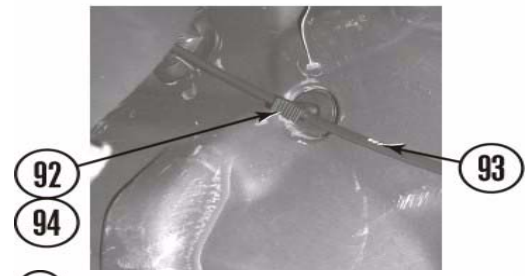

- h. Install fuel filler (105) on the bed (104) with three bolts (103).
- i. Install gas cap (102).

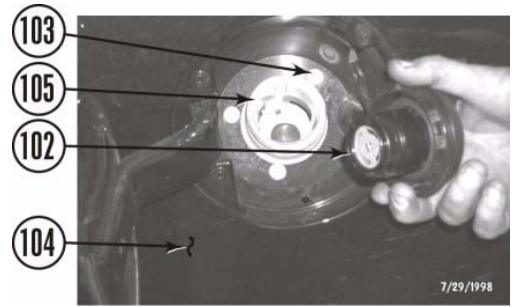

14. Along the frame rails.

- a. Measure 1" forward of the holes on each side of the frame (16) from which you removed the bolts (66) and safety cables (67).
- b. Mark and drill a 1/2" hole on each side. Ensure the drill does not contact fuel and brake lines inside the frame (16).

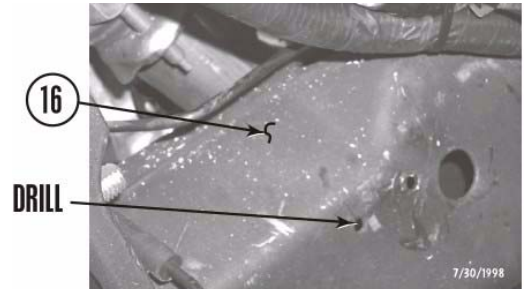

- c. Install safety cable (67) in new hole in the frame (16) driver side with bolt (66).

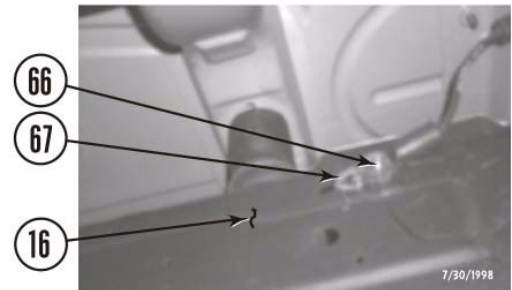

- d. Secure harness (65) to hard line (55) with two *kit* zip ties (149).

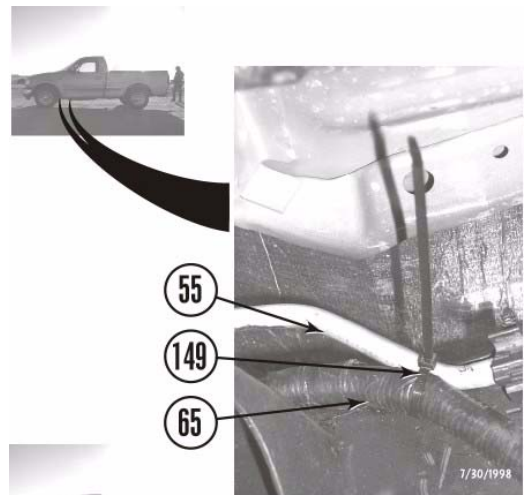

- e. Ensure there is enough slack in line (150) through grommet (151) on driver side shock tower (152) so wheel travel will not break line. If line does not have enough slack, pull some line through grommet towards wheel.

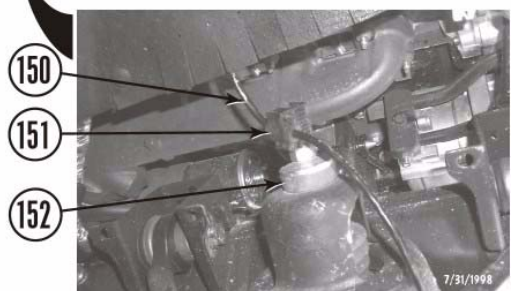

- f. Install safety cable (67) in new hole in the frame (16) passenger side with bolt (66).



- g. Install *kit* bracket (153) on frame (16) passenger side with bolt (70).

- h. Install ground strap (71) on *kit* bracket (153) with *kit* 1/4 x 1" bolt (154), two *kit* 1/4" SAE washers (155), and *kit* 1/4" nylock nut (156).

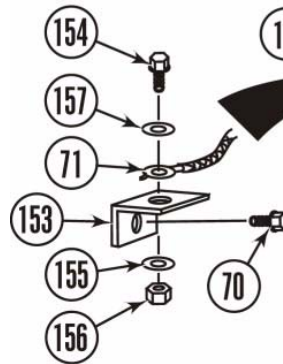

- i. Install *kit* bracket (157) on frame (16) passenger side with bolt (68).

- j. Bend bracket (69) 90 degrees as shown and install on *kit* bracket (157) with *kit* 1/4 x 1" bolt (154), two *kit* 1/4" SAE washers (155), and *kit* 1/4" nylock nut (156). Ensure negative battery cable (158) will reach battery (3).

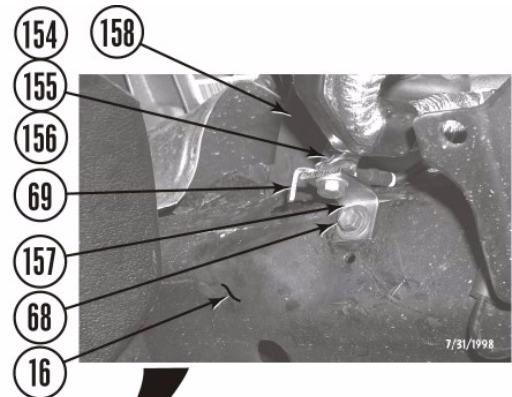

- k. Ensure there is enough slack in line (159) though grommet (160) on passenger side shock tower (161) so wheel travel will not break line. If line does not have enough slack, pull some line through grommet towards wheel.

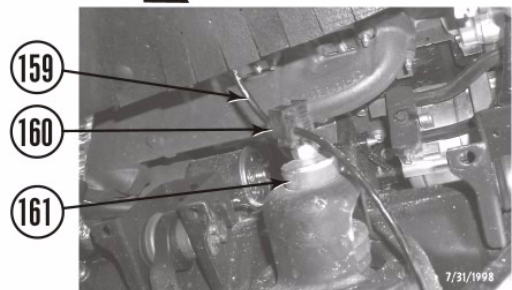

15. Under the hood.

- a. Cut top click-in mounting tabs (25) and lower mounting tabs (162) off of the fan shroud (22).

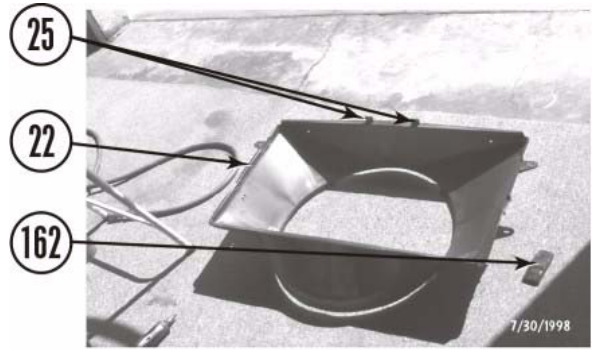

- b. Position fan shroud (22) in vehicle and rest on fan.
- c. Install radiator (24) and four brackets (47 and 48) on core support (14) with two bolts with captive washers (46).



- d. Squeeze two clamps (42 and 43) and install upper radiator hose (44) and lower radiator hose (45) on radiator (24).

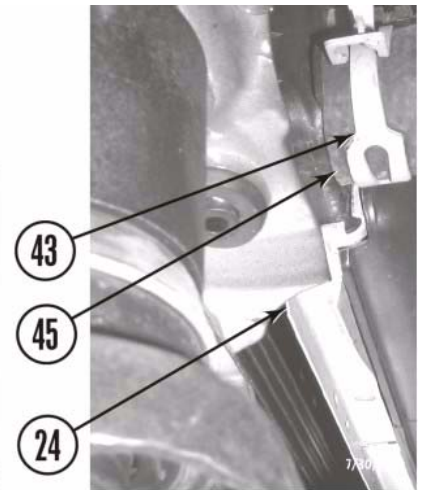
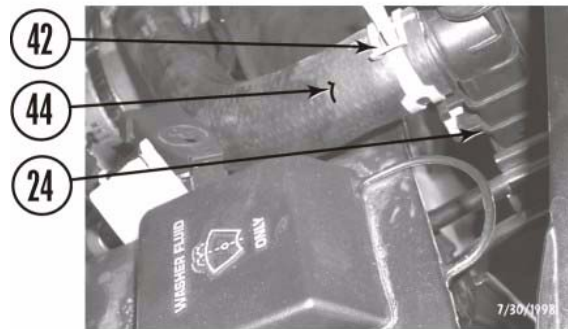

- e. If removed, install two automatic transmission cooling lines (40 and 41).
- f. Squeeze clamp (38) and install hose (44) on radiator (24).

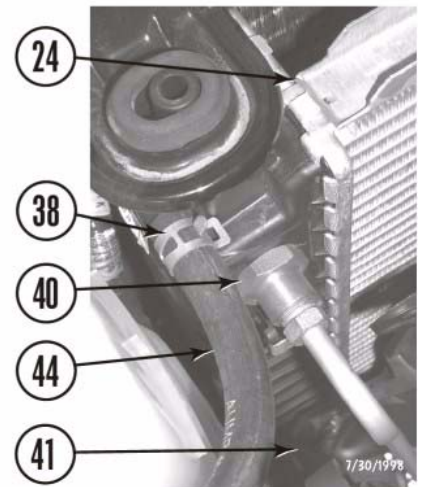

- g. Fill radiator (24) and replace radiator cap (36). Radiator must be topped off after vehicle is started.

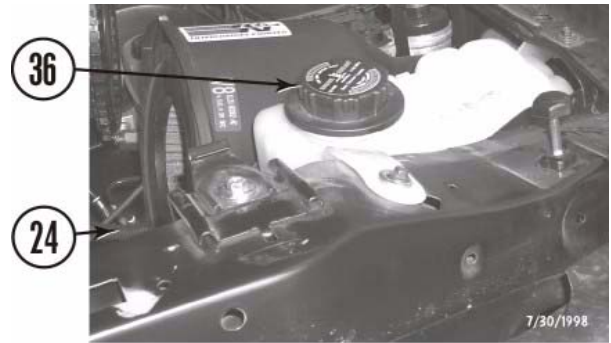

- h. Install two *kit* fan shroud mounting brackets (163) on radiator (24) with two screws (23). Do not tighten.
- i. Install fan shroud (22) on *kit* mounting brackets (163) with two *kit* 1/4" SAE washers (155) and *kit* 1/4" nylock nuts (156). Do not tighten.
- j. Check fan to fan shroud clearance. Ensure gap is the same all around shroud and tighten screws (23) and nuts (156).

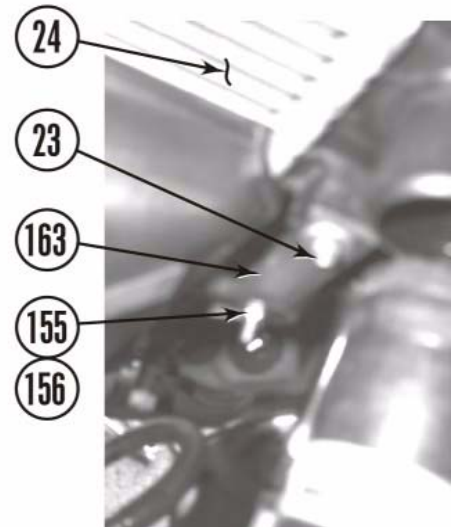

- k. Install *kit* lower fan shroud support bracket (164) on core support (14) with bolt (61).
- l. Using the *kit* lower fan shroud support bracket (164) as a template, mark and drill a 5/16" hole in the fan shroud (22).
- m. Install fan shroud (22) on *kit* bracket (164) with *kit* 1/4 x 1" bolt (154), two *kit* 1/4" SAE washers (155), and *kit* 1/4" nylock nut (156). Ensure bolt (154) threads point out of shroud. Turn fan by hand and ensure fan does not contact fan shroud.

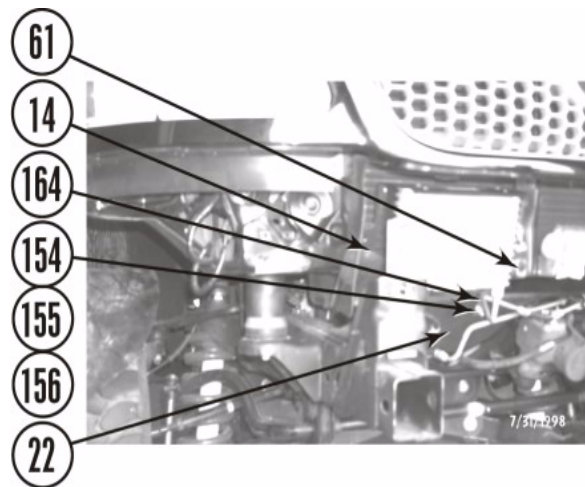

- n. Install power steering cooler (60) on core support (14) with two screws (59) (lines may need to be carefully bent in order to clear).

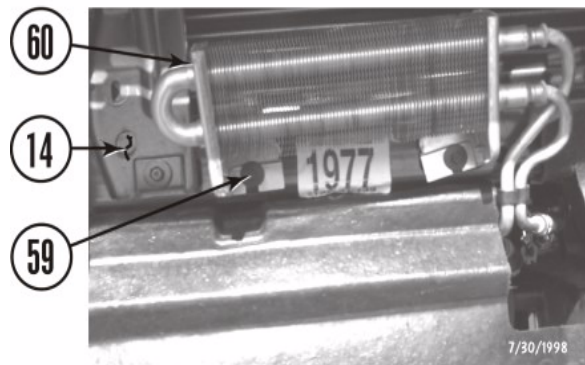

- o. Install transmission cooler (58) on core support (14) with three screws (57).

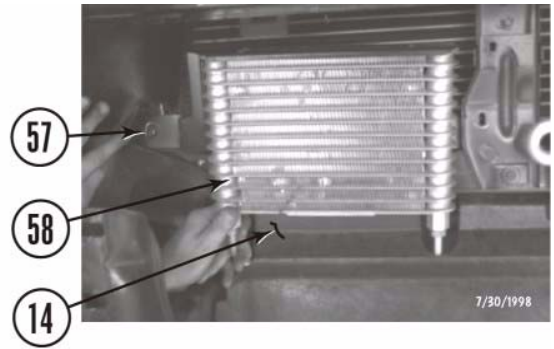

- p. Tighten nut (52) and bracket (54) on stud (53).
- q. Carefully bend lines (50 and 51) so they clear fan shroud (22) and do not rub on anything.
- r. Install lines (50, 51, and 55) in clips (49 and 56) when possible.

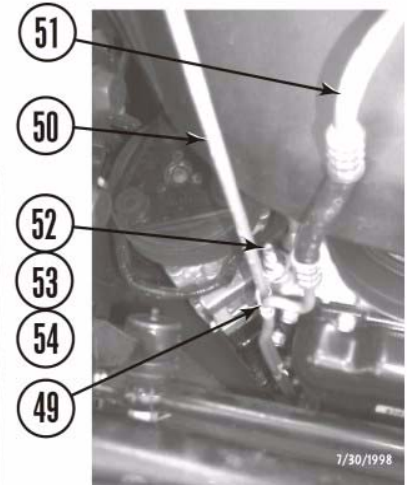

- s. Position air duct (30) on air filter housing (33) and tighten clamp (32).



- t. Tighten clamp (31) on air duct (32) and throttle body (30).
- u. Install two hoses (33) on air duct (32) and throttle body (30).

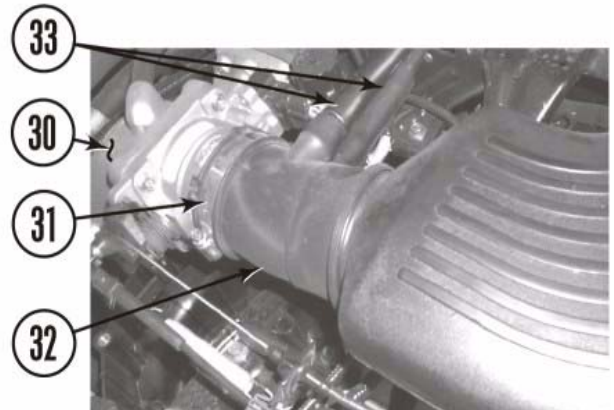

- v. Install cover (29) on throttle body (30) with three screws with captive washers (28).

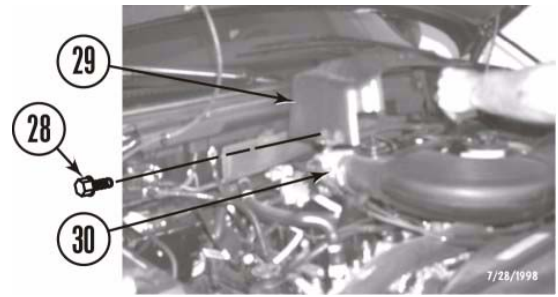

- w. Install radiator shroud (21) on core support (14) with seven screws (20).

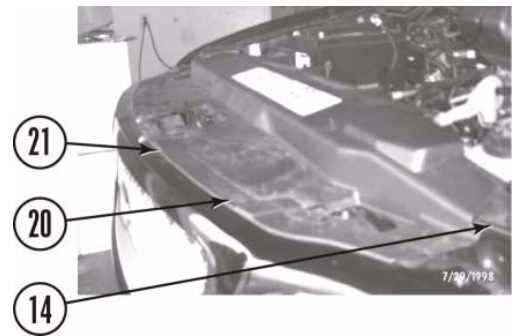

- x. Tie radiator shroud (21) on fan shroud (22) with two kit zip ties (165).

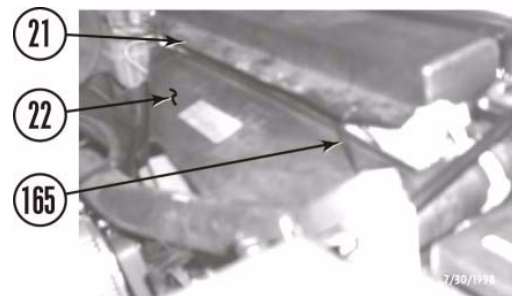

- y. Replace spare tire crank (26) in clips (27).

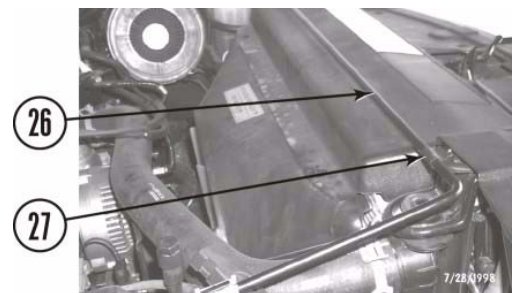

⚠WARNING

The following procedure is intended only to enhance the appearance of the vehicle. The rear bumper will no longer be rated for towing of any kind. Towing with the rear bumper after it has been lifted can result in death, serious personal injury, or damage to the vehicle. Towing after the bumper has been lifted should be accomplished using a rated Class III receiver type hitch.

⚠NOTE

For 2" kit only, install rear bumper in stock location using stock fasteners. Adjust bumper to body clearance.

16. Install the rear bumper.

- a. Coat threads of bolts (166) and nuts (19) with Loctite®.
- b. Position two *kit* brackets (167) on frame (16) and install two *kit* 7/16 x 1 1/2" bolts (166), four *kit* 7/16" USS washers (168), and two *kit* 7/16" nylock nuts (169). Hand tighten.
- c. Mark frame (16) in center of holes in *kit* brackets (167) as shown. Remove *kit* brackets from frame.
- d. Drill two holes in frame (16) as shown. Elongate holes horizontally for bumper adjustment.
- e. Position two *kit* brackets (167) on frame (16) and install four *kit* 7/16 x 1 1/2" bolts (166), eight *kit* 7/16" USS washers (168), and four *kit* 7/16" nylock nuts (169). Do not tighten.
- f. Position rear bumper (18) on kit brackets (167) and install four nuts (19). Do not tighten.
- g. Adjust bumper to body clearance and tighten bolts (166) and nuts (19) to 55 lb-ft.
- h. Connect two license plate lights (17) in rear bumper (18).
- i. Measure down three inches from existing spare tire crank hole (170) and, using 1" hole saw, drill new hole. Remove plastic collar (171) and install in new hole.

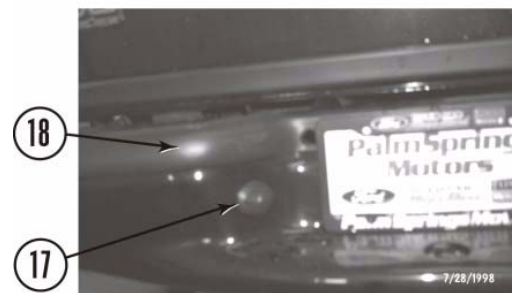
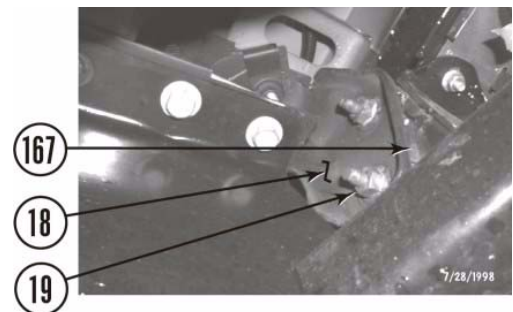
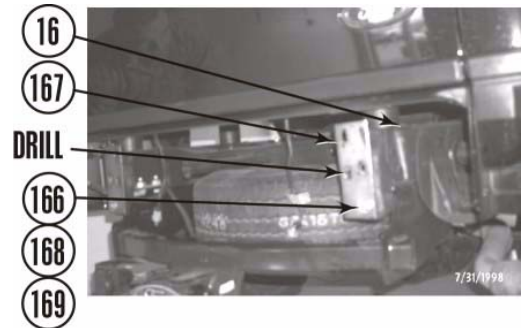

17. Install the front bumper.

NOTE

To raise the front bumper of a vehicle equipped with tow hooks, tow hooks cannot be reinstalled unless front bumper valence is trimmed for clearance.

- a. If so equipped, remove two bolts (172) and tow hooks (173) from front frame horns (174).
- b. Cut material from the front frame horns (174) as shown. Remove enough metal so bottom of bumper will clear.
- c. Coat threads of bolts (166) and nuts (15) with Loctite®.
- d. Install two *kit* brackets (175) on frame (16) behind stock mounts as shown with two *kit* 7/16 x 1 1/2" bolts (166), four *kit* 7/16" USS washers (168), and two *kit* 7/16" nylock nuts (169).
- e. Install front bumper (8) on frame (16) and *kit* brackets (175) with four nuts (15). Do not tighten.
- f. Adjust bumper to body clearance and tighten bolts (166) and nuts (15) to 55 lb-ft.
- g. If removed, connect two connectors (10) on fog lamps (11).

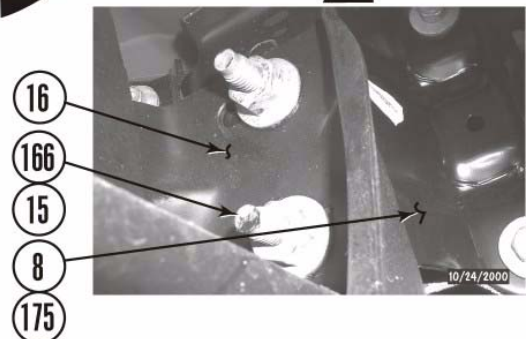
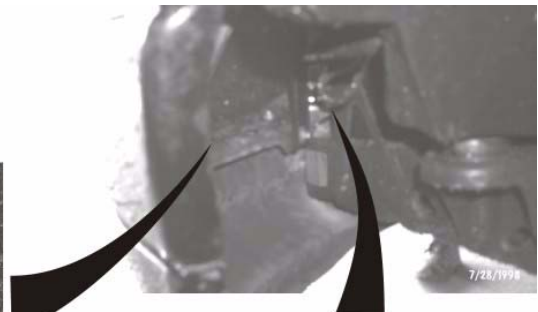
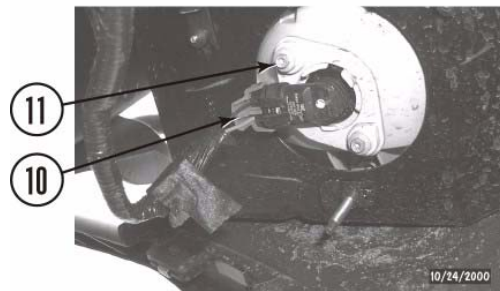
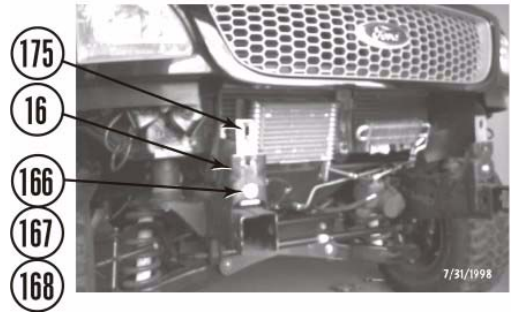
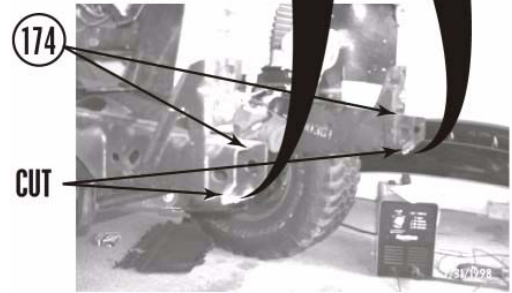

- h. Install air flap (11) on front bumper (8) and core support (12) with eight panel clips (10).

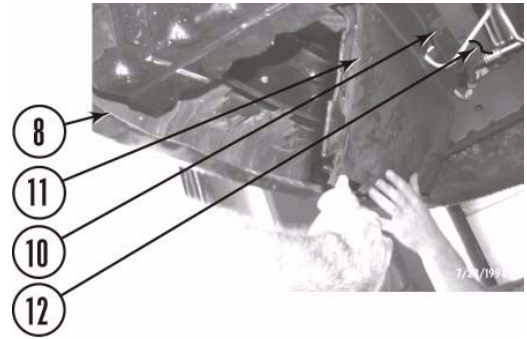

- i. If so equipped, install tow hooks (173) on front frame horns (174) with two bolts (172).



⚠ CAUTION
A certified welder should perform all welding.

18. Install bed crush blocks.

- a. Weld two (four - long bed) *kit* bed overload spacers (176) on the frame (16) over the rear wheel wells as shown.

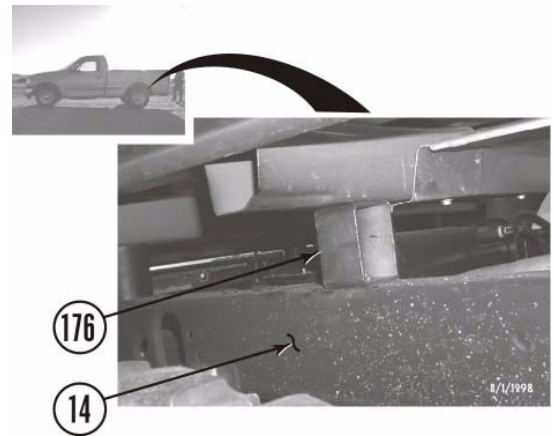

D. After installation is complete.

- 1. Install airbag fuse (6) in fuse panel (7). Install two covers (4 and 5).

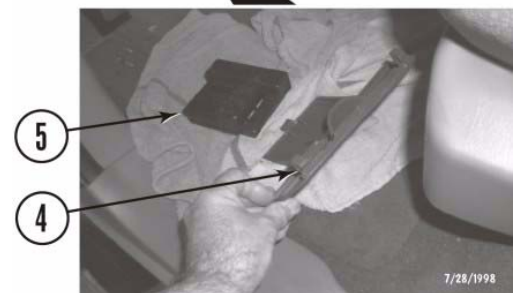

2. Connect both battery cables to the battery (3). Be sure to reconnect the positive cable (2) first, then the negative cable (1).
3. Stick *kit* warning sticker on the dash in plain sight of all vehicle occupants.
4. Double check the vehicle.

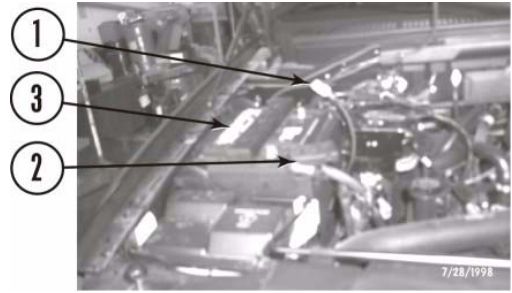

⚠CAUTION

Retorque all fasteners after 500 miles and after off road use. All body lift components should be visually inspected and fasteners retorqued during routine vehicle servicing.

- a. Check all mounting hardware to ensure it is properly tightened.
- b. Check all wires, hoses, cables, etc. to ensure they have been properly connected and there is ample slack. With the number of hoses on this vehicle, it is vital that this be checked thoroughly.
- c. Check vehicle electrical system.
- d. Start vehicle and check the steering in both directions to ensure that there is no bind. Check clutch operation. Check the operation of the brake system and the parking brake. Check both shift levers' operation. Ensure that there is proper engagement in all gears and 4 wheel drive ranges.

⚠CAUTION

Never open a closed cooling system after the vehicle has been started. Only fill the cooling system if the cap has been removed while the vehicle was still cold.

- e. Check coolant level. Fill coolant to the proper level (refer to the Owner's Manual).
- f. Test drive vehicle in all gears and 4 wheel drive ranges. Pay close attention to all vehicle systems. Check all hardware again in 500 miles and as part of your regular maintenance schedule.

⚠CAUTION

Performance Accessories does not recommend any particular wheel and tire combinations for use with its body lifts and cannot assume responsibility for the customer's choice of wheels and tires. Reference your owner's manual for recommended tire sizes and warnings related to the use of oversized tires. Larger wheel and tire combinations increase stress and wear on steering and suspension components, which leads to increased maintenance and higher risk for component failure. Larger wheel and tire combinations also alter speedometer calibration, braking effectiveness, center of gravity, and handling characteristics. Consult with an experienced local off road shop to find what wheel and tire combinations work best with your vehicle.

⚠NOTE

All warranty information, instruction sheets, and other documents regarding the installation of this product must be retained by the vehicle owner. Information contained in the instructions and on the warranty card will be required for any warranty claims. The vehicle owner needs to understand the modifications made to his vehicle and how they affect vehicle handling and performance. Failure to provide the customer with this information can result in damage to the vehicle and severe personal injury.

E. Kit Parts List

Description	Quantity
Block , lift, 2" (height) x 3" (diameter) (862 only)	16
Block , lift, 3" (height) x 3" (diameter) (863 only)	16
Bolt , 12mm-1.75 x 120mm (862 only).....	4
Bolt , 12mm-1.75 x 140mm (863 only).....	4
Bolt , 12mm-1.75 x 160mm (862 only).....	10
Bolt , 12mm-1.75 x 180mm	
862	2
863	10
Bolt , 12mm-1.75 x 200mm (863 only).....	2
Bolt , 1/4" x 1"	3
Bolt , 3/8" x 1 1/4", Allen head	1
Bolt , 5/16" x 1"	2
Bolt , 7/16" x 1 1/2"	
862	2
863	6
Bracket , automatic transmission.....	1
Bracket , fan shroud, lower.....	1
Bracket , fan shroud, upper	
2" hole-to-stud (862)	2
3" hole-to-stud (863)	2
Bracket , front bumper	2
Bracket , ground strap	2
Bracket , rear bumper (863 only).....	2
Crush block (bed spacer), metal	
2" (862).....	4
3" (863).....	4
Hose , rubber, 3/4" x 13" (fuel filler vent).....	1
Hose clamp , #10	2
Hose clamp , #28	2
Label (sticker), logo.....	1
Label (sticker), warning.....	1
Loctite , 6ml bottle	1
Nut , 1/4" Nylock.....	5
Nut , 5/16" Nylock.....	2
Nut , 7/16" Nylock	
862	2
863	6
Pin , 1/2" x 2", round rod (4WD shift lever).....	1
Pin , 1/2" x 3", round rod (4WD shift lever).....	1
Steering extension	1
Tube , fuel filler, 1 1/2" x 5	1
Washer , 1/4" SAE	8
Washer , 5/16" SAE	4
Washer , 7/16" USS	
862	12
863	20
Washer , 1/2" ID x 1 3/4" OD x 3/16" thick	8

Bracket, automatic transmission



Bracket, fan shroud, lower

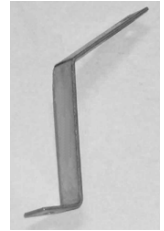

Bracket, fan shroud, upper (863 shown; 862 is shorter)



Bracket, front bumper



Bracket, ground strap



Bracket, rear bumper (863 only)

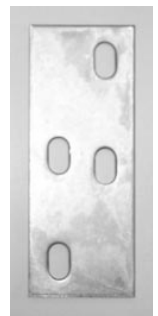

△NOTE

Depending on the vehicle configuration (automatic or manual transmission, 2WD or 4WD, cab and bed length, etc.), some parts might not be needed.