



INSTALLATION INSTRUCTIONS

1075 North Ave. Sanger, CA 93657-3539 local: 559-875-0222 fax: 559-876-2259 toll free: 800-445-3767

2350

2" DROP SPINDLE 2WD

(Must Use 18" Wheels or larger see instructions on Pg. 3)

97-03 FORD F-150 STD CAB, EXT CAB, SUPER CREW

97-04 FORD LIGHTNING — 97-03 FORD EXPEDITION

CONGRATULATIONS!

You were selective enough to choose a **BELLTECH PRODUCT**. We have spent many hours developing our line of products so that you will receive maximum performance with minimum difficulty during installation

Note: Confirm that all of the hardware listed in the parts list is in the kit. **DO NOT** begin this installation if any part is missing. Read the instructions thoroughly before beginning this installation.

Warning: **DO NOT** work under a vehicle supported by only a jack. Place support stands securely under the vehicle in the manufacturer's specified locations unless otherwise instructed.

Warning: **DO NOT** drive the vehicle until all work has been completed and checked. Torque all hardware to values specified.

Reminder: Proper use of safety equipment and eye/face/hand protection is absolutely necessary when using these tools to perform procedures!

Note: It is very helpful to have an assistant available during the installation process.

Note: We **DO NOT RECOMMEND** using wheel ramps while performing this installation.

RECOMMENDED TOOLS:

- Blocks and Wheel chocks
- Ratcheting Socket Wrench
- Safety Glasses
- Properly rated floor jacks and support stands
- Combination Wrench
- Torque wrench: 0-75 lb ft. range

1 KIT INSTALLATION

- 1a.** Open the hardware kit and remove all of the contents. Refer to the parts list (Page 3) to verify that all parts are present.
- 1b.** Park the vehicle on a smooth, level concrete or seasoned asphalt surface and activate the parking brake. Block the FRONT wheels of the vehicle with appropriate wheel chocks; making sure the vehicle's transmission is in 1st gear (manual) or "Park" (automatic).
- 1c.** Using a properly rated floor jack, lift the REAR wheels of the vehicle off the ground. Place support stands, rated for the vehicle's weight and in the factory specified locations. Refer to the vehicle Owner's Manual. Prior to lowering the vehicle onto the stands, make sure the supports will securely contact the chassis.
- 1d.** It is very important that the vehicle is properly supported during this installation to prevent personal injury and chassis damage. Make sure that the support stands are properly placed prior to performing the following procedures. We **DO NOT RECOMMEND** using wheel ramps while performing this installation.

- 1e. Slowly lower the vehicle onto the stands and, before placing the vehicle's entire weight on them, again check that they properly and securely contact the chassis as described above. Check for possible interference with any lines, wires, cables, or other easily damaged components.

1. Steering Knuckle Removal

Starting on the driver's side of the vehicle remove the wheel from the steering knuckle (**Photo 1**).

- 1a. Remove the brake caliper assembly from the steering knuckle with a 18mm socket (**Photo 2**). With a metal hook or wire attach the caliper to chassis so that it doesn't dangle and damage the brake line (**Photo 3**).
 - 1b. Remove the bearing cap, cotter pin, nut, and washer from the spindle pin (**Photo 4**).
 - 1c. Remove the brake rotor (**Photo 5**).
 - 1d. Remove the backing plate by removing the three screws from the steering knuckle with a 8mm socket or wrench (**Photo 6**). Also make sure to remove the foam washer between the backing plate and steering knuckle.
 - 1e. Remove the sensor from the steering knuckle with a 8mm socket or wrench (**Photo 7**).
- ! Belltech recommends using a lever style or puller style ball joint removal tool and in some cases it is helpful to use a large hammer and forcefully strike the ball joint boss. This striking action will usually free the ball joint with one swing. We do not recommend the use of a fork style ball joint separator because they can damage the ball joint and cut the grease cup.
- 1f. Remove the steering arm tie rod end
 - 1g. Unthread the upper control arm ball joint nut using a 21mm socket or wrench. Its helpful to keep the ball joint nut partially threaded on to keep the arm from swinging up and to keep it in place while removing the lower ball joint. Use one of the above removal methods to remove the ball joint from the steering knuckle.
 - 1h. Partially unthread the lower ball joint nut for ball joint removal using a 24mm socket. Use one of the above removal methods to remove the ball joint from the steering knuckle (**Photo 8**).
- ! It is helpful to use a jack or lifting device to raise the lower control while removing the spindle ball joints. Be very cautious when lifting the lower control arm because it is under extreme load. Make sure the lifting device base is stable and the portion connected to the lower control isn't able to slip out.
- 1i. Finally remove upper and lower ball joint nuts to free the steering knuckle from the vehicle (**Photo 9**).

2. Steering Knuckle Installation

- 2a) Locate the new Belltech steering knuckle and install it onto the upper, lower and steering arm ball joints.
- 2a1) Tighten and torque the lower ball joint to 65 ft lbs and install the new supplied cotter pin.
- 2a2) Tighten and torque the upper ball joint to 50 ft lbs and install the new supplied cotter pin.
- 2a3) Tighten and torque the tie rod ball joint to 50 ft lbs and install the new supplied cotter pin.

NOTE: The Belltech steering knuckle has an inverted tie rod for better performance (**Photo 10**).

- 2b. Re-install the sensor to the steering knuckle with the stock bolt using a 8mm socket (**Photo 11**).

- 2c. Before reinstalling the backing plate to the steering knuckle you will need to insert the foam washer between the plate and steering knuckle (**Photo 12**).

- 2d. Re-install the backing plate to the steering knuckle using the three stock bolts and a 8mm socket (**Photo 13**).

- 2e. Install the brake rotor onto the spindle (**Photo 14**).

! NOTE: The wheel bearings should be checked and properly greased before re-assembly.

- 2f. Install the outer wheel bearing onto the spindle then attach the new washer and nut (**Photo 15**). Tighten the wheel-bearing nut to the factory specifications. Insert the new cotter pin and reattach the bearing grease cap (**Photo 16**).

- 2g. Install the brake caliper onto the steering knuckle with the two stock bolts. With a 18mm socket, torque the two bolts to 100 ft lbs (**Photo 17**).

- 2h. Rotate the steering knuckle in both directions to check if the brake line and sensor cable have proper clearance.

- 2i. Driver's side installation is complete repeat steps 1-18 for passenger's side.

IMPORTANT NOTE:

INSTRUCTIONS FOR 18" WHEELS

- !** When using 18" wheels you must use the supplied nut and lock washer on the lower ball joint, then trim the ball joint stud for adequate clearance (illustrations 18). The supplied lock washer and nut should be installed and torqued to 60 ft. lbs. before the ball joint stud is trimmed. It is recommended that when you remove the lower portion of the stud you leave at least 1/16" of the stud extended out from the nut. It is also recommended that once the stud is trimmed off you use a chisel or punch to score the edge of the threads to prevent any possibility of the nut coming loose (illustration 18).

3. **FINAL ASSEMBLY AND ADJUSTMENTS**

- 3a. Check that all components and fasteners have been properly installed, tightened and torqued.
- 3b. Check the brake hoses, and other components for any possible interference.
- 3c. Lift the vehicle and remove the support stands. Carefully lower the vehicle to the ground.
- 3d. Visually inspect the wheel alignment after the vehicle has been set down and rolled to relieve any pressure. It might be necessary to manually adjust the toe on the steering arms before the vehicle is driven.
- 3e. Immediately test-drive the vehicle in a remote location so that you can become accustomed to the revised driving characteristics and handling. Be aware that the vehicle will handle substantially different now that it has been modified.
- 3f. **We recommend** the vehicle be taken in to a qualified wheel alignment facility to be realigned to factory specifications. This should be done after the vehicle has been test driven and all modifications have been completed.
- 3g. Installation is complete. Check all of the hardware and re-torque at intervals for the first 10, 100, 1000 miles.

4. FINALIZING THE INSTALLATION

4a. Tighten the bushing bracket and tighten to 18ft-lbs.

All hardware being fastened to the vehicle's original fastening points should be torqued to the proper specifications. To prevent chassis damage, never over-torque the hardware.

4b. Check that all components and fasteners have been properly installed, tightened and torqued.

4c. Check brake hoses and other components for any possible interference.

4d. Lift the vehicle and remove the support stands. Carefully lower the vehicle to the ground.

4e. Immediately test-drive the vehicle in a remote location so that you can become accustomed to the revised driving characteristics and handling. Be aware that the vehicle will handle substantially different now that it has been modified.

4f. Installation is complete. Check all of the hardware and re-torque at intervals for the first 10, 100, 1000 miles.

**PART LIST
DROPPED**

PART#	DESCRIPTION	QTY
2350-350	Steering Knuckle LH	1
2350-450	Steering Knuckle RH	1
112600	Bearing Washer 3/4"	2
112601	Castle Nuts 3/4"-20	2
110910	Cotter Pins 1/8" x 1-1/2	4
115009	Internal Tooth Lock Washer 5/8"	2
115012	Half Nut 16mm x 1.5	2

**FOR 2350
SPINDLE KIT**

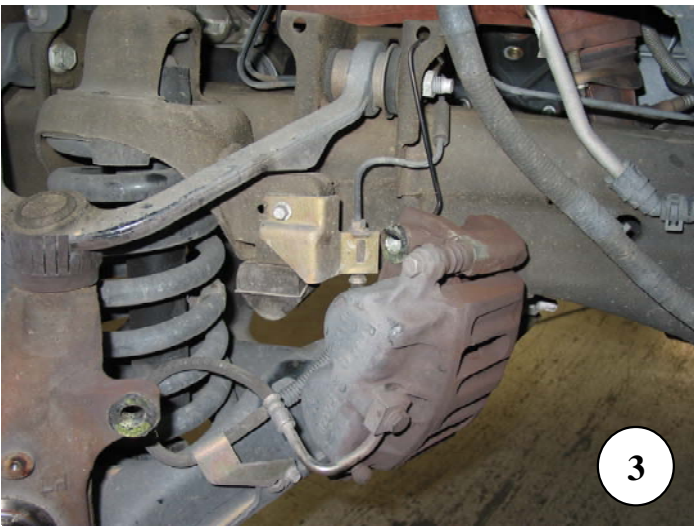
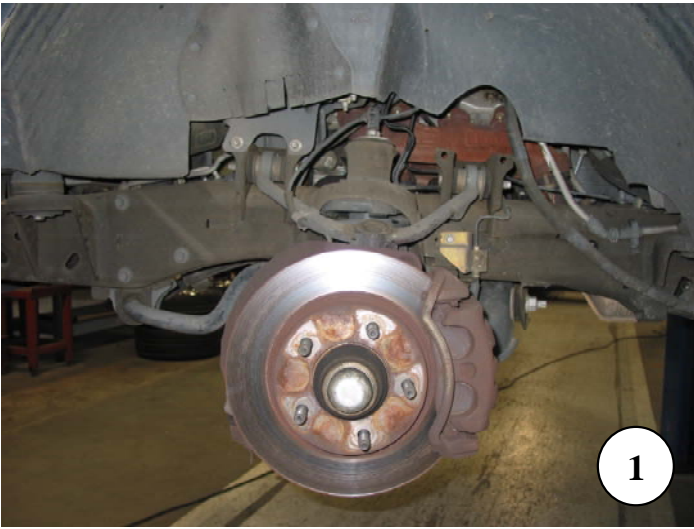

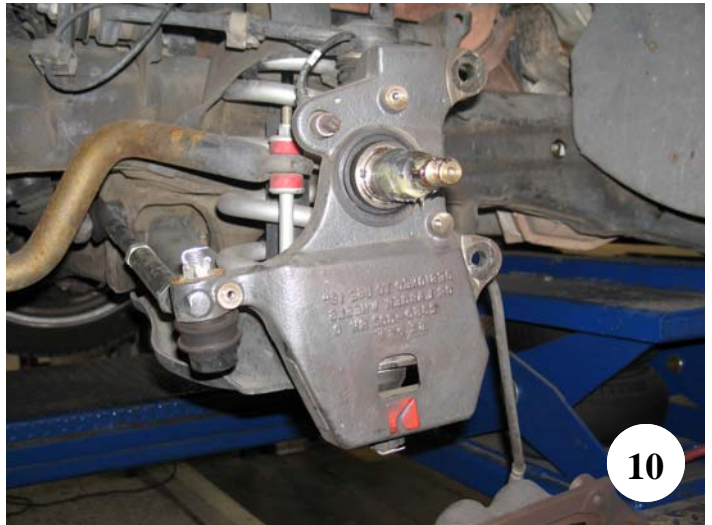
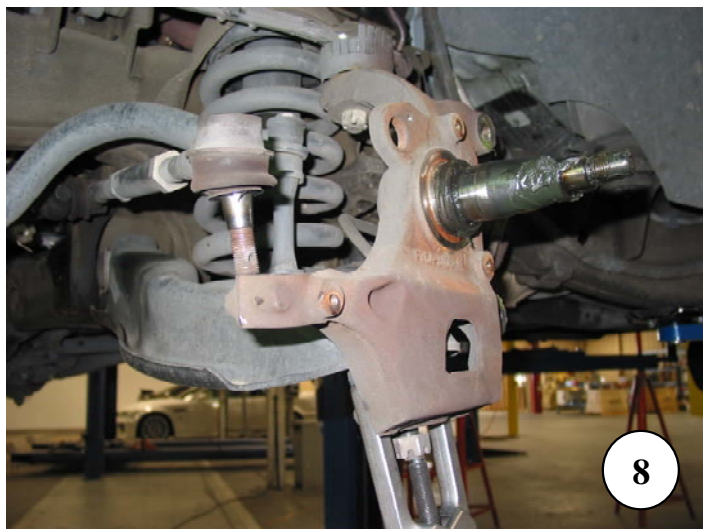
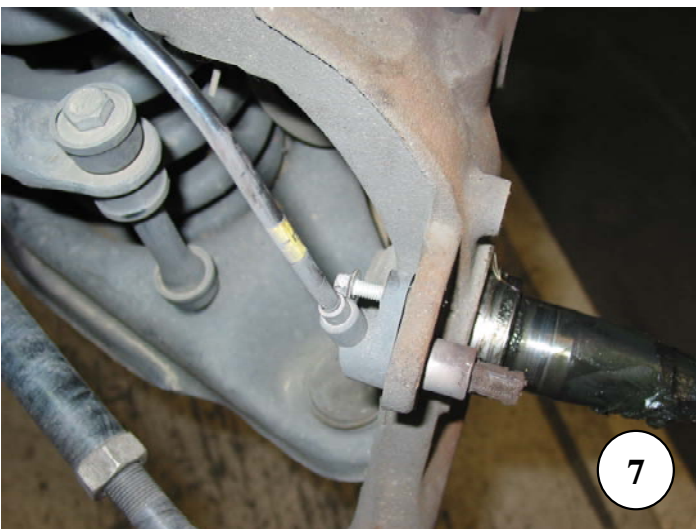
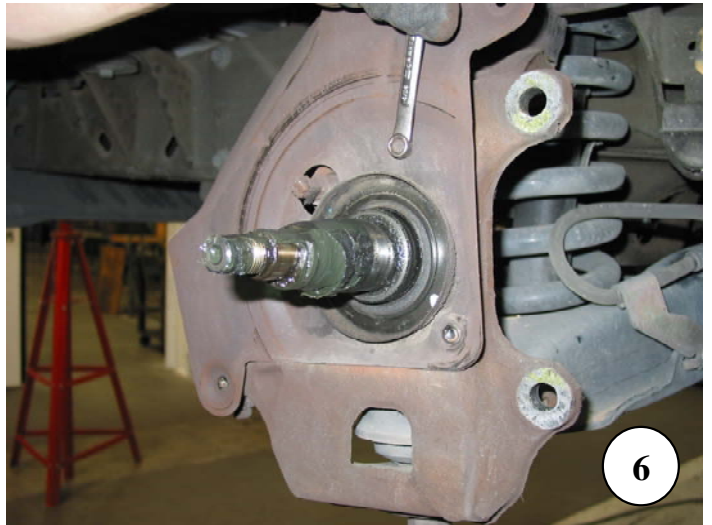

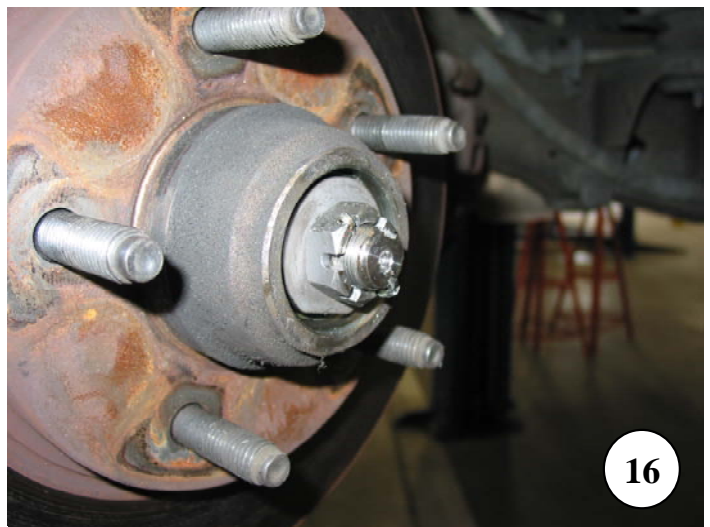
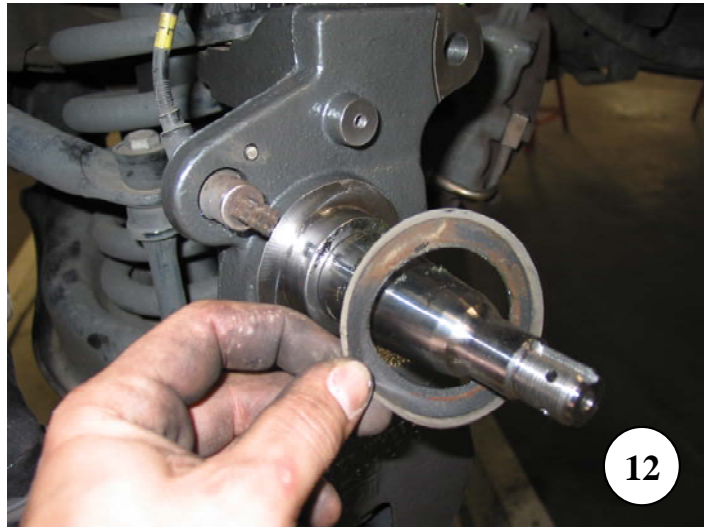
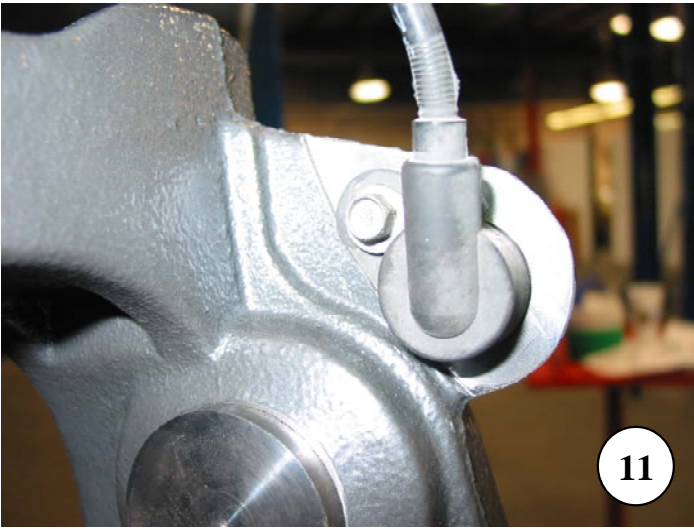

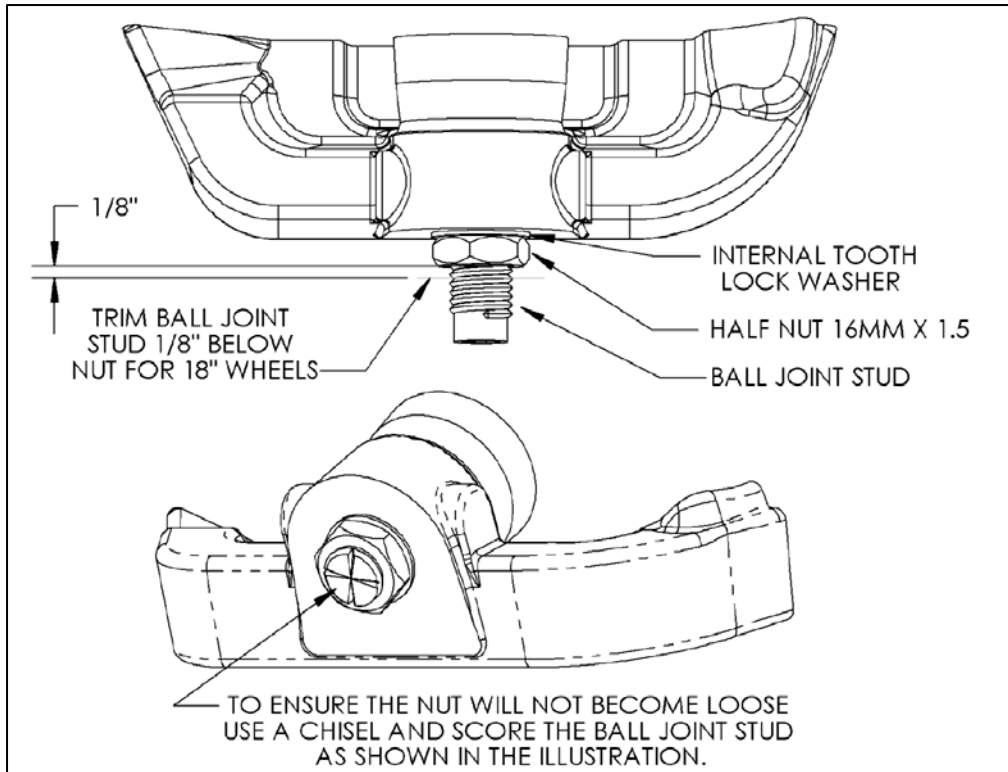

ILLUSTRATION 18