



1201AA

78-88 GMA/G-BODY

Double Adjustable Trailing Arms

**Thank you for your purchase from our new line of GM parts.
Please call us at (877) 4NO-ROLL if you have any questions
regarding the service or installation of your Hotchkis products.
Visit us online @ www.hotchkis.net**

Warning: This installation should be performed by a trained professional.

INSTALLATION INSTRUCTIONS

1. First, raise the rear of the vehicle so that the rear wheels are off the ground. If you are using a 2-post lift, support the differential with a hydraulic tranny jack.
2. Remove the rear shocks.
3. Remove the rear sway bar from the lower trailing arms.
4. Allow the differential to droop as far down as possible.
5. Remove the stock upper trailing arms.
6. As an initial starting point, set the Hotchkis trailing arms to the same length (hole to hole) as the stock pieces. Do not fully tighten the jam nuts yet.
7. Reinstall the Hotchkis trailing arms in the same manner as stock removal.
8. Continue to the next section "Setting Pinion Angle"

SETTING PINION ANGLE

It may be necessary to set pinion angle after installation of your new Hotchkis upper trailing arms.

First of all, what is pinion angle? Pinion angle is basically the angle between the centerline of the differential pinion and the drive shaft centerline. This angle changes during acceleration and braking. If the pinion angle is excessive, then vibration and increased U-joint wear will occur.

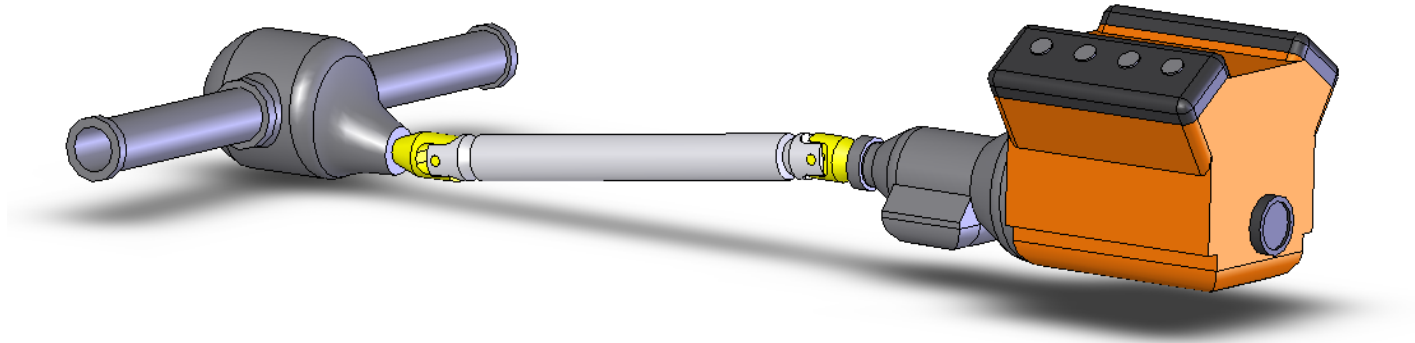

The Hotchkis double adjustable trailing arms allow you to adjust the pinion angle with ease. Simply loosen the two jam nuts and rotate the aluminum turnbuckle to lengthen or shorten the arm. So, how does one set the pinion angle?

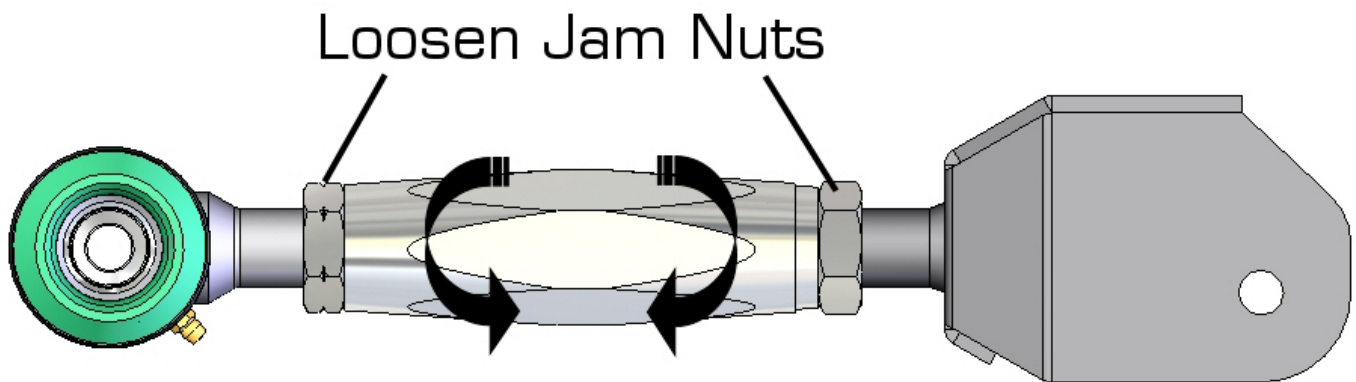

The simplest rule of thumb is:

The centerline of the differential pinion should be parallel to the centerline of the engine's crankshaft without being the same line.

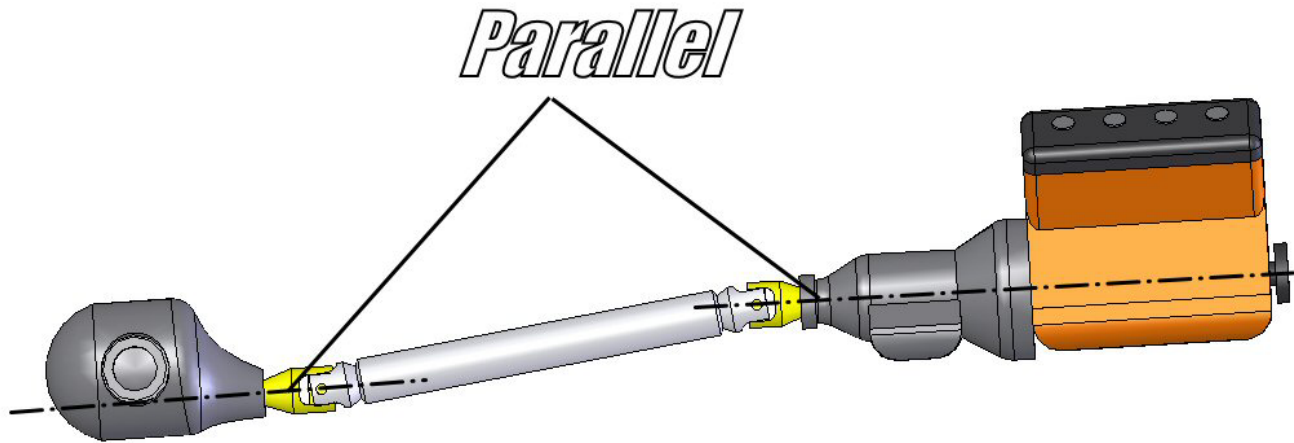

FYI... The centerlines should not be the same line because the U-joints would wear in the same areas all the time. Having an angle at the joint itself allows the joint to articulate and wear evenly along the entire bearing race.

So, the first thing to do is to find out the angle the engine's crankshaft is sitting at. One way to do this is to set a digital angle finder on the front crank pulley or harmonic balancer. Record this angle. Next, set the digital angle finder on the front flat face of the differential yoke. This angle needs to be the same as the recorded crank angle. Adjust your Hotchkis trailing arms to obtain the angle needed.

Tighten all hardware and drive the car. Test for driveline vibration by accelerating.

If there is vibration during acceleration, then the pinion angle is set too high!

During Acceleration

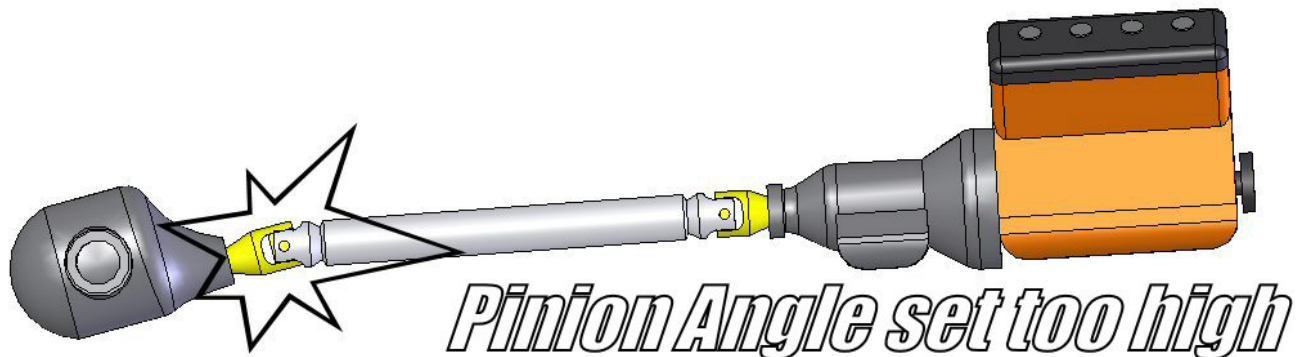

If there is vibration during braking, then the pinion angle is set too low!

During Braking

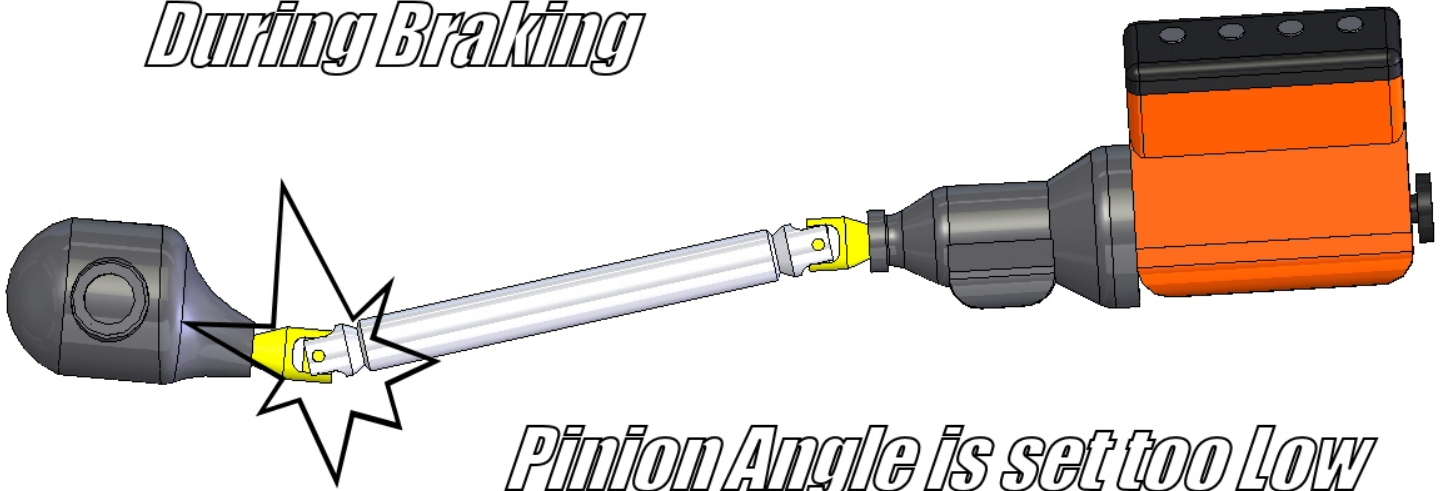

Fine tune your Hotchkis trailing arms to achieve the perfect setting for your driving style and horsepower.

During Acceleration

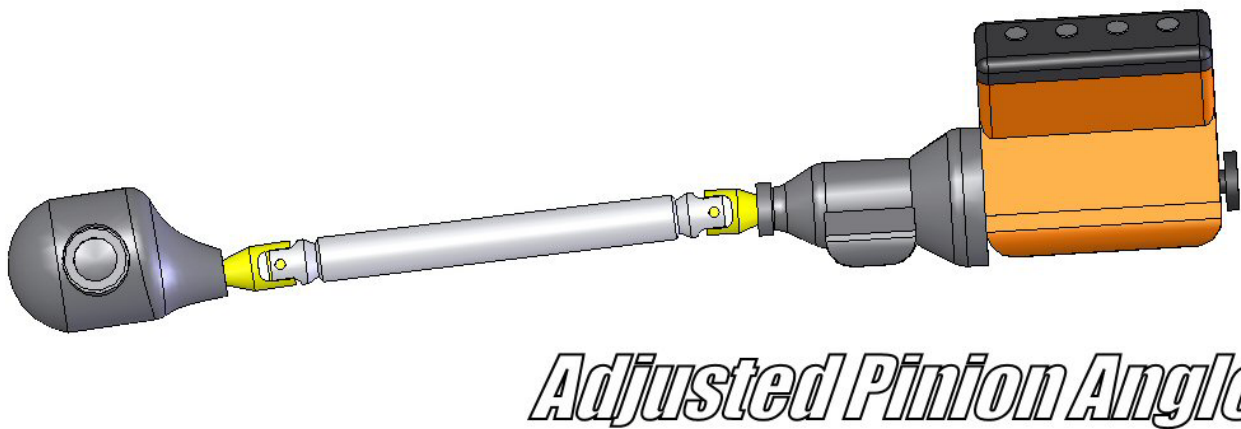



Hotchkis Performance LLC
Return Policy & Limited Warranty

Effective December 1, 2010 all Hotchkis products must be registered to qualify for warranty at www.hotchkis.net or via the mail-in warranty card, included with the product, within 30 days of the original purchase date.

IMPORTANT: This warranty supersedes all other warranties included with this product.

Return Policy

We want you to be completely satisfied with your Hotchkis Performance product. For products, presenting signs of shipping damage please contact the freight carrier immediately. All our products are guaranteed to be free from manufacturer's defects. If your order arrives with a manufacture defect, please contact our Customer Service Department at (562) 907-7757. You will be assigned a Returned Goods Authorization Number (RGA). The package you return must show the RGA on the outside of the package, include the original invoice and be shipped prepaid to our facility. The product has to be unused and in its original packaging materials. Exchanges or refunds made after 30 days will be subject to a 20% restocking charge. **If you purchased your Hotchkis Performance product from an authorized dealer, you are still covered by this return policy. All returns however, should be made to your dealer, not to Hotchkis Performance directly.**

Limited Warranty

Hotchkis Performance offers a Limited Warranty against defects in materials and workmanship for the term of 36 months (3 years) from the date of purchase of this product. This Warranty only applies to the original retail purchaser who retains ownership of the vehicle on which the product was originally installed. If the product is determined to be defective, Hotchkis Performance will repair, replace or refund the purchase price of the defective product at Hotchkis Performance's sole discretion, which shall fully satisfy and discharge any and all warranty claims. Any repaired or replaced product will be returned to the sender excluding the cost of freight. **Products must be registered to qualify for warranty at www.hotchkis.net or via the mail-in warranty card, included with the product, within 30 days of the original purchase date.**

Exclusions from Warranty

Items offered but not manufactured by Hotchkis Performance are warranted according to the manufacturer's terms and are not covered by this limited warranty. Hotchkis Performance shall not be responsible for any labor, removal, installation, re-installation or maintenance costs. This warranty does not cover the cosmetic finish or plating of any product or any normal wear and tear to any product including, but not limited to bushings, brackets, end-links, hardware, steering components, shocks or springs. In addition, this warranty does not apply to any products that have been:

- Improperly installed or installed by someone other than a qualified, licensed auto mechanic experienced in the installation and removal of suspension products;
- Improperly serviced, misused, or modified, altered or subjected to abuse, negligence, accident or collision;
- Installed in any vehicle that has been modified;
- Installed on any vehicle that has carried loads in excess of automobile manufacturer suggested weight limits; or
- Installed on any vehicle that has been subject to abnormal or excessive use, including rallying, racing, or racing-type activities or off-road use.

Limitation of Warranty

This limited warranty is the entire and only warranty for the products and may not be modified or supplemented by any other person or company in any form. Any description of the products, by anyone, is for the sole purpose of identifying them and is not part of the basis of the bargain, and does not constitute a warranty that the products will conform to that description. The statements of any salesperson do not constitute part of this limited warranty and cannot be relied upon as a warranty.

THERE ARE NO WARRANTIES, EXPRESSED OR IMPLIED, INCLUDING ANY IMPLIED WARRANTIES OF MERCHANTABILITY OR FITNESS FOR A PARTICULAR PURPOSE, WHICH EXTEND BEYOND THE DESCRIPTION ON THE FACE HEREOF. ANY IMPLIED WARRANTIES ARE DISCLAIMED TO THE

FULLEST EXTENT PERMITTED BY LAW. THIS WARRANTY DOES NOT COVER CONSEQUENTIAL DAMAGES, LOSS OF TIME OR REVENUES, INCONVENIENCE, LOSS OF USE OF THE VEHICLE, DAMAGE TO THE VEHICLE OR COMPONENTS OF THE VEHICLE, ANY OTHER TYPE OF CONSEQUENTIAL DAMAGES, OR OTHER INCIDENTAL OR INDIRECT DAMAGES. HOTCHKIS' MAXIMUM LIABILITY UNDER THIS WARRANTY SHALL IN NO EVENT EXCEED THE PURCHASE PRICE OF THE PRODUCT. Some states do not allow limitations on how long an implied warranty lasts or the exclusion or limitation of incidental or consequential damages and in such states the above limitations or exclusions may not apply. This limited warranty gives the purchaser specific legal rights and the purchaser may have other rights that may vary from state to state.

Technical Information

Hotchkis Performance makes every effort to ensure that you are provided with the most accurate and up-to-date technical information. However, all technical information is approximate and may vary upon application. Additional suspension components may be needed in some applications, depending upon the make, model, engine and chassis of the vehicle. Hotchkis Performance is not responsible for any consequences resulting from manufacturer's technical mid-year changes. Hotchkis Performance products should only be installed by a qualified, licensed auto mechanic experienced in the installation of such products.

Warranty Claim Procedure:

The answer to ALL the following questions should be YES before making a warranty claim:

- Did you register the product at www.hotchkis.net or via the mail-in warranty card within 30 days of purchase?
- Is the product appropriate to your application?
- Did you carefully and thoroughly read the instructions provided along with the product?
- Do you have the original invoice or sales receipt?
- Is the return date within 36 months from the purchase date?
- Are you the original purchaser?
- Was the product properly installed by a qualified, licensed auto mechanic?
- Has the product been installed on the original vehicle on which it was installed at all times?
- Is the product unmodified and clean?
- Is the reason for return a legitimate product defect?

If the answer to all these questions is YES, please contact our Customer Service Department at (562) 907-7757. You will be given a Returned Goods Authorization Number (RGA) valid for 60 days. You will also be asked to ship the product prepaid to our facility. All shipments MUST be (i) prepaid, (ii) include the original invoice or sales receipt, (iii) show the RGA on the outside of the package and (iv) include your name, address, make and model of the vehicle, and a brief description of the claimed defect, including the circumstances under which the defect occurred. If the warranty claim is deemed valid then Hotchkis will estimate shipping costs to return the repaired or replacement part and contact you for payment. Hotchkis's Limited warranty requires that any repaired or replaced product will be returned to the sender excluding the cost of freight. Warranty related inquires should be sent to the following address:

**HOTCHKIS PERFORMANCE, LLC
C/O CUSTOMER SERVICE
8633 Sorensen Avenue
SANTA FE SPRINGS, CA 90670**

Hotchkis Performance will not accept product returns without the RGA number, receipt and the information described above. C.O.D. or collect shipments will be refused. Once the returns are received at Hotchkis Performance, we will evaluate the products, verify the sales receipt, and investigate the warranty claim. Any repaired or replaced product will be returned to the sender.

Effective December 1, 2010. This return policy and limited warranty supersedes all previous policy and warranty statements. Policies and warranties are subject to change without notice. Hotchkis Performance is not responsible for printing errors.



INSTALLATION INSTRUCTIONS

1301 / 1302 / 1305 / 1306

THANK YOU FOR CHOOSING HOTCHKIS PERFORMANCE PRODUCTS

Removal of Stock Lower Trailing Arms

- 1) Place car on level surface.
- 2) Support rear of the car on jack stands and remove the rear wheels.
- 3) Remove the rear sway bar. (if car is equipped-not required on Camaro/Firebird)
- 4) Place a floor jack under the differential and lift up slightly to remove tension from the trailing arm bolts-make sure not to lift the car off the jack stands.

KEEP THE FLOOR JACK UNDER THE CAR DURING THE COMPLETE REMOVAL AND INSTALLATION PROCEDURE.

CAUTION- DO NOT REMOVE BOTH TRAILING ARMS AT THE SAME TIME OR THE AXLE WILL ROTATE AND THE TRAILING ARM INSTALLATION WILL BECOME MUCH MORE DIFFICULT.

- 5) Start with either lower trailing arm and remove the rear bolt.
- 6) Then remove the front trailing arm bolt using a socket with an extension-place the socket through the outer hole in the frame to loosen the nut (Does not apply to F body). **Caution** – be careful not to drop the bolt into the frame – if you do then remove the bolt through the large hole on the underside of the frame.
- 7) Remove the unbolted trailing arm.
- 8) Clean the frame at the trailing arm pivot area with a wire brush.

Installation of HP Lower Trailing Arms

Hotchkis performance trailing arms are fully assembled, greased and ready to install.

- 1) Apply a thin layer of chassis grease to faces of bushings before installation.
- 2) Install HP trailing arms with the grease fittings facing down and the sway bar mounting holes toward the **rear** of the car.
- 3) Install the new trailing arm by locating the front bolt first.
- 4) Place one drop of blue **Loctite** on clean threads and torque the nut to 70 ft./lbs.
- 5) The trailing arm should then pivot smoothly on the chassis.
- 6) Install the rear bolt.
- 7) Place one drop of blue **Loctite** on clean threads and torque nut to 70 ft./lbs.
- 8) Install the rear sway bar using the stock or supplied bolts. (7/16" on early models-10mm late models 78 on) (1305 trailing arms have supplied hardware) **Does not apply to F body.**

- 9) Place one drop of blue **Loctite** on clean threads and torque sway bar nuts to 35 ft./lbs.
Note: **Loctite** not needed if using new Hotchkis Performance hardware.
- 10) The holes located on the Hotchkis Performance lower control arms are for the mounting of our sway bar.

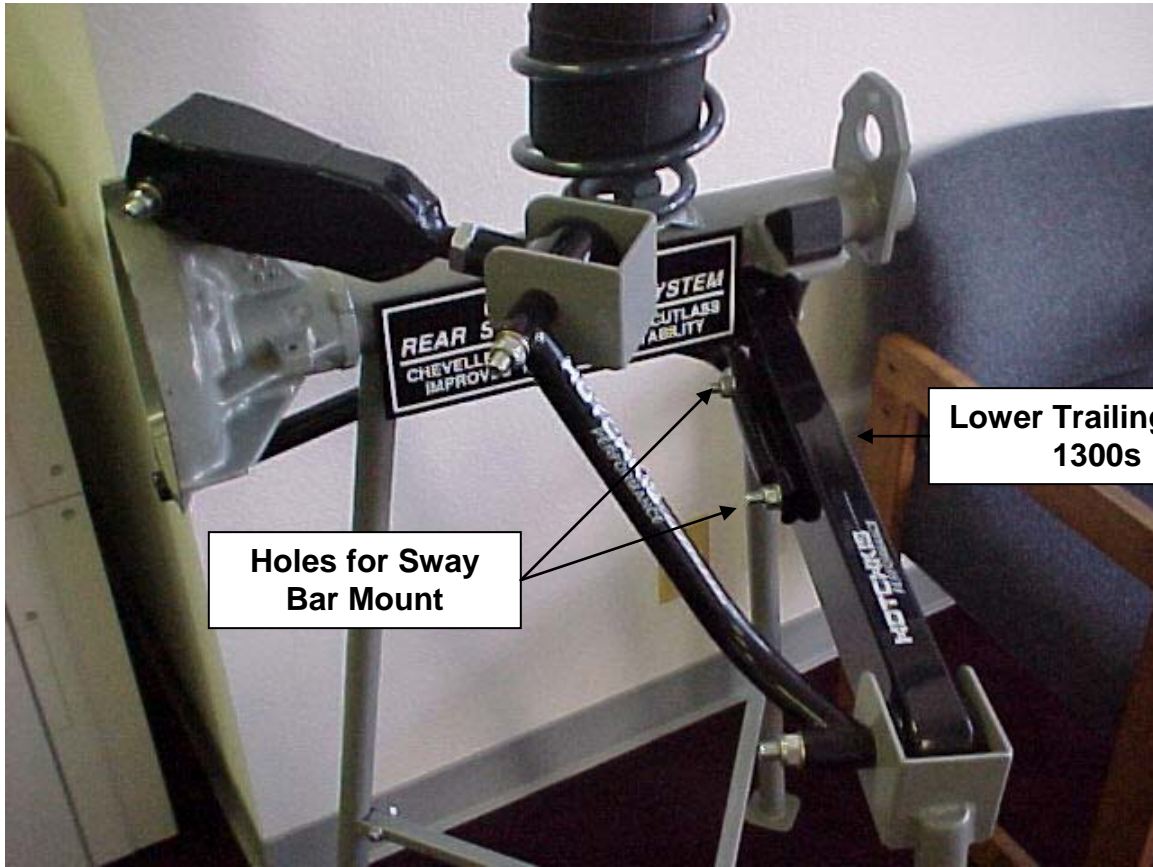

HOTCHKIS HOTCHKIS SPORT SUSPENSION

Hotchkis Performance LLC
Return Policy & Limited Warranty

Effective December 1, 2010 all Hotchkis products must be registered to qualify for warranty at www.hotchkis.net or via the mail-in warranty card, included with the product, within 30 days of the original purchase date.

IMPORTANT: This warranty supersedes all other warranties included with this product.

Return Policy

We want you to be completely satisfied with your Hotchkis Performance product. For products, presenting signs of shipping damage please contact the freight carrier immediately. All our products are guaranteed to be free from manufacturer's defects. If your order arrives with a manufacture defect, please contact our Customer Service Department at (562) 907-7757. You will be assigned a Returned Goods Authorization Number (RGA). The package you return must show the RGA on the outside of the package, include the original invoice and be shipped prepaid to our facility. The product has to be unused and in its original packaging materials. Exchanges or refunds made after 30 days will be subject to a 20% restocking charge. **If you purchased your Hotchkis Performance product from an authorized dealer, you are still covered by this return policy. All returns however, should be made to your dealer, not to Hotchkis Performance directly.**

Limited Warranty

Hotchkis Performance offers a Limited Warranty against defects in materials and workmanship for the term of 36 months (3 years) from the date of purchase of this product. This Warranty only applies to the original retail purchaser who retains ownership of the vehicle on which the product was originally installed. If the product is determined to be defective, Hotchkis Performance will repair, replace or refund the purchase price of the defective product at Hotchkis Performance's sole discretion, which shall fully satisfy and discharge any and all warranty claims. Any repaired or replaced product will be returned to the sender excluding the cost of freight. **Products must be registered to qualify for warranty at www.hotchkis.net or via the mail-in warranty card, included with the product, within 30 days of the original purchase date.**

Exclusions from Warranty

Items offered but not manufactured by Hotchkis Performance are warranted according to the manufacturer's terms and are not covered by this limited warranty. Hotchkis Performance shall not be responsible for any labor, removal, installation, re-installation or maintenance costs. This warranty does not cover the cosmetic finish or plating of any product or any normal wear and tear to any product including, but not limited to bushings, brackets, end-links, hardware, steering components, shocks or springs. In addition, this warranty does not apply to any products that have been:

- **Improperly installed or installed by someone other than a qualified, licensed auto mechanic experienced in the installation and removal of suspension products;**
- **Improperly serviced, misused, or modified, altered or subjected to abuse, negligence, accident or collision;**
- **Installed in any vehicle that has been modified;**
- **Installed on any vehicle that has carried loads in excess of automobile manufacturer suggested weight limits; or**
- **Installed on any vehicle that has been subject to abnormal or excessive use, including rallying, racing, or racing-type activities or off-road use.**

Limitation of Warranty

This limited warranty is the entire and only warranty for the products and may not be modified or supplemented by any other person or company in any form. Any description of the products, by anyone, is for the sole purpose of identifying them and is not part of the basis of the bargain, and does not constitute a warranty that the products will conform to that description. The statements of any salesperson do not constitute part of this limited warranty and cannot be relied upon as a warranty.

THERE ARE NO WARRANTIES, EXPRESSED OR IMPLIED, INCLUDING ANY IMPLIED WARRANTIES OF MERCHANTABILITY OR FITNESS FOR A PARTICULAR PURPOSE, WHICH EXTEND BEYOND THE DESCRIPTION ON THE FACE HEREOF. ANY IMPLIED WARRANTIES ARE DISCLAIMED TO THE FULLEST EXTENT PERMITTED BY LAW. THIS WARRANTY DOES NOT COVER CONSEQUENTIAL DAMAGES, LOSS OF TIME OR REVENUES, INCONVENIENCE, LOSS OF USE OF THE VEHICLE, DAMAGE TO THE VEHICLE OR COMPONENTS OF THE VEHICLE, ANY OTHER TYPE OF CONSEQUENTIAL DAMAGES, OR OTHER INCIDENTAL OR INDIRECT DAMAGES. HOTCHKIS' MAXIMUM LIABILITY UNDER THIS WARRANTY SHALL IN NO EVENT EXCEED THE PURCHASE PRICE OF THE PRODUCT. Some states do not allow limitations on how long an implied warranty lasts or the exclusion or limitation of incidental or consequential damages and in such states the above limitations or exclusions may not apply. This limited warranty gives the purchaser specific legal rights and the purchaser may have other rights that may vary from state to state.

Technical Information

Hotchkis Performance makes every effort to ensure that you are provided with the most accurate and up-to-date technical information. However, all technical information is approximate and may vary upon application. Additional suspension components may be needed in some applications, depending upon the make, model, engine and chassis of the vehicle. Hotchkis Performance is not responsible for any consequences resulting from manufacturer's technical mid-year changes. Hotchkis Performance products should only be installed by a qualified, licensed auto mechanic experienced in the installation of such products.

Warranty Claim Procedure:

The answer to ALL the following questions should be YES before making a warranty claim:

- **Did you register the product at www.hotchkis.net or via the mail-in warranty card within 30 days of purchase?**
- **Is the product appropriate to your application?**
- **Did you carefully and thoroughly read the instructions provided along with the product?**
- **Do you have the original invoice or sales receipt?**
- **Is the return date within 36 months from the purchase date?**
- **Are you the original purchaser?**
- **Was the product properly installed by a qualified, licensed auto mechanic?**
- **Has the product been installed on the original vehicle on which it was installed at all times?**
- **Is the product unmodified and clean?**
- **Is the reason for return a legitimate product defect?**

If the answer to all these questions is YES, please contact our Customer Service Department at (562) 907-7757. You will be given a Returned Goods Authorization Number (RGA) valid for 60 days. You will also be asked to ship the product prepaid to our facility. All shipments MUST be (i) prepaid, (ii) include the original invoice or sales receipt, (iii) show the RGA on the outside of the package and (iv) include your name, address, make and model of the vehicle, and a brief description of the claimed defect, including the circumstances under which the defect occurred. If the warranty claim is deemed valid then Hotchkis will estimate shipping costs to return the repaired or replacement part and contact you for payment. Hotchkis's Limited warranty requires that any repaired or replaced product will be returned to the sender excluding the cost of freight. Warranty related inquires should be sent to the following address:

**HOTCHKIS PERFORMANCE, LLC
C/O CUSTOMER SERVICE
8633 Sorensen Avenue
SANTA FE SPRINGS, CA 90670**

Hotchkis Performance will not accept product returns without the RGA number, receipt and the information described above. C.O.D. or collect shipments will be refused. Once the returns are received at Hotchkis Performance, we will evaluate the products, verify the sales receipt, and investigate the warranty claim. Any repaired or replaced product will be returned to the sender.

Effective December 1, 2010. This return policy and limited warranty supersedes all previous policy and warranty statements. Policies and warranties are subject to change without notice. Hotchkis Performance is not responsible for printing errors.

⁺ HOTCHKIS SPORT SUSPENSION

1401 / 1402 / 1403 ADJUSTABLE TRAILING ARM MOUNT BRACES

1401 – 78-88 GM A/G-BODY / 1402 – 68-72 GM A-BODY / 1403 – 64-67 GM A-BODY

Thank you for your purchase.

Please call us at (562) 907-7757 if you have any questions regarding your Hotchkis Performance products.

Visit us online @ www.hotchkis.net

INSTALLATION OF HOTCHKIS PERFORMANCE ADJUSTABLE TRAILING ARM MOUNT BRACES

ALWAYS USE CAUTION! - AND MAKE SURE THE CAR IS SECURE ON JACK STANDS.

- 1) Place the vehicle on a level surface. Block the front tires.
- 2) Use a jack to lift the rear of the car until the suspension is at full droop and the tires are no longer contacting the ground. Support the rear of car on jack stands.
- 3) Place the jack under the differential. This will be used later to lower or raise the axle for ease of installation.
- 4) Use a ratchet or wrench to remove rear shock absorbers at the lower mounts. This should free up the springs to be removed.



- 5) Using the jack placed under the differential, raise the rear suspension to its approximate ride height. The braces are generally easier to install with the rear axle at its normal ride height position to the frame.

NOTE: Be careful not to unload the weight of car off the jack stands.

To keep the axle from rotating, **install one brace at a time**. **Do not** have trailing arm bolts removed from opposite sides at the same time.

- 6) Remove one front upper trailing arm bolt and replace with supplied longer bolt and washer. Push bolt through trailing arm until about 1/2" of thread is showing. A short amount of thread makes it easier to slide the brace onto the bolt.

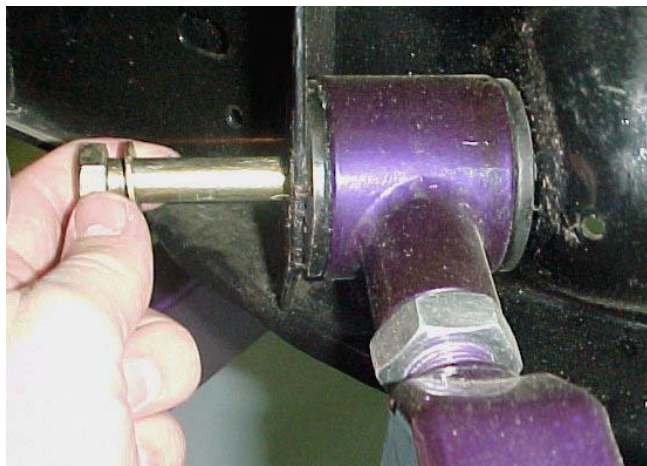

NOTE: If the emergency brake cable covers the upper trailing arm bolt, then this cable will have to be moved slightly. Do this by removing the cable bracket bolt just above the pinion. Push the cable aside for the brace clearance.

- 7) Repeat step 6 for the front bolt of the lower trailing arm. Access to this bolt should be through a hole in the outside of the frame that can be reached with a socket and ratchet extension.

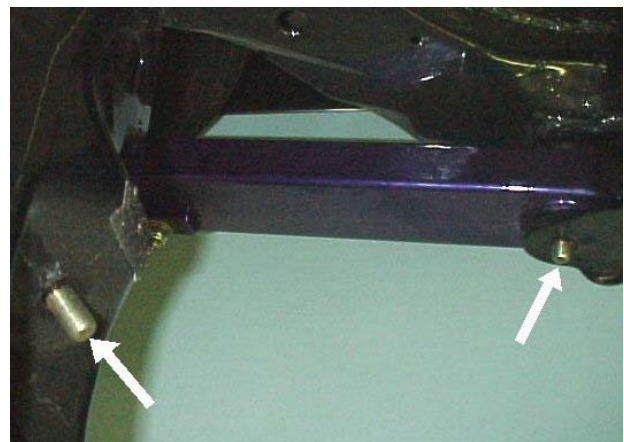

These pictures were taken on a bare frame for reference.

- 8) The brace can now be installed by sliding it over the bolts. The braces connect the upper and lower trailing arm frame mounts as indicated by the arrows in the photo from step 7. The longer section of the brace fits next to the lower trailing arm.



NOTE: For 78-88 models (part #1401) the curved section fits next to the lower trailing arm between the rear seat pan and the frame cross-member as shown in the photos below.



- 9) Adjust the length of the brace as necessary. Loosen the jamb nut on the brace with 15/16” wrench to allow the head to move. Rotate the head **clockwise to shorten** the brace or **counter-clockwise to lengthen** the brace until it fits over the ends of the bolts. The brace ends should fit almost flush to the frame with the bolts fully extended through the ends.



YOU WILL NOT, be able to determine if you have the right brace length until you have fully extended the bolts and the brace fits without causing the hardware to bind.

Hand-tighten the jamb nut on the brace. Place the washers included over the bolt ends and start the nylock nuts on the bolt ends to make sure the bolts don't pull out, and move on to the next step.

Special Note (68-72 Models): Due to tolerances in these models it may be necessary to clearance the floor pan to fit these braces. Use a body hammer to clearance the floor pan from the braces.

- 10) Repeat the installation & adjustment procedures for the opposite side.

- 11) Once the braces are installed, place one drop of ***Loctite*** on the trailing arm bolt threads. Tighten the washers and nuts. Torque the nuts to 60 ft./lbs. You may have to use a wrench and socket together to keep the hardware from spinning.

NOTE: If using rubber trailing arm bushings, then raise the differential to approximate ride height and tighten the trailing arm bolts. Polyurethane equipped trailing arms can be tightened at full suspension droop.



- 12) Use the 15/16" wrench from before to tighten the jamb nut on the brace.
- 13) Replace the brake cable if it was moved earlier.
- 14) Re-install the springs and bolt the shocks back into place. **CHECK THAT ALL HARDWARE IS TIGHT!** Lower the jack from the differential and remove the jack. Use the jack to remove the jack stands supporting the rear of the vehicle. Remove the blocks from the front wheels and you're done with the installation!

CHECK ALL NUT AND BOLT TIGHTNESS AFTER FIRST 10 MILES





Hotchkis Performance LLC Return Policy & Limited Warranty

Effective December 1, 2010 all Hotchkis products must be registered to qualify for warranty at www.hotchkis.net or via the mail-in warranty card, included with the product, within 30 days of the original purchase date.

IMPORTANT: This warranty supersedes all other warranties included with this product.

Return Policy

We want you to be completely satisfied with your Hotchkis Performance product. For products, presenting signs of shipping damage please contact the freight carrier immediately. All our products are guaranteed to be free from manufacturer's defects. If your order arrives with a manufacture defect, please contact our Customer Service Department at (562) 907-7757. You will be assigned a Returned Goods Authorization Number (RGA). The package you return must show the RGA on the outside of the package, include the original invoice and be shipped prepaid to our facility. The product has to be unused and in its original packaging materials. Exchanges or refunds made after 30 days will be subject to a 20% restocking charge. **If you purchased your Hotchkis Performance product from an authorized dealer, you are still covered by this return policy. All returns however, should be made to your dealer, not to Hotchkis Performance directly.**

Limited Warranty

Hotchkis Performance offers a Limited Warranty against defects in materials and workmanship for the term of 36 months (3 years) from the date of purchase of this product. This Warranty only applies to the original retail purchaser who retains ownership of the vehicle on which the product was originally installed. If the product is determined to be defective, Hotchkis Performance will repair, replace or refund the purchase price of the defective product at Hotchkis Performance's sole discretion, which shall fully satisfy and discharge any and all warranty claims. Any repaired or replaced product will be returned to the sender excluding the cost of freight. **Products must be registered to qualify for warranty at www.hotchkis.net or via the mail-in warranty card, included with the product, within 30 days of the original purchase date.**

Exclusions from Warranty

Items offered but not manufactured by Hotchkis Performance are warranted according to the manufacturer's terms and are not covered by this limited warranty. Hotchkis Performance shall not be responsible for any labor, removal, installation, re-installation or maintenance costs. This warranty does not cover the cosmetic finish or plating of any product or any normal wear and tear to any product including, but not limited to bushings, brackets, end-links, hardware, steering components, shocks or springs. In addition, this warranty does not apply to any products that have been:

- Improperly installed or installed by someone other than a qualified, licensed auto mechanic experienced in the installation and removal of suspension products;
- Improperly serviced, misused, or modified, altered or subjected to abuse, negligence, accident or collision;
- Installed in any vehicle that has been modified;
- Installed on any vehicle that has carried loads in excess of automobile manufacturer suggested weight limits; or
- Installed on any vehicle that has been subject to abnormal or excessive use, including rallying, racing, or racing-type activities or off-road use.

Limitation of Warranty

This limited warranty is the entire and only warranty for the products and may not be modified or supplemented by any other person or company in any form. Any description of the products, by anyone, is for the sole purpose of identifying them and is not part of the basis of the bargain, and does not constitute a warranty that the products will conform to that description. The statements of any salesperson do not constitute part of this limited warranty and cannot be relied upon as a warranty.

THERE ARE NO WARRANTIES, EXPRESSED OR IMPLIED, INCLUDING ANY IMPLIED WARRANTIES OF MERCHANTABILITY OR FITNESS FOR A PARTICULAR PURPOSE, WHICH EXTEND BEYOND THE DESCRIPTION ON THE FACE HEREOF. ANY IMPLIED WARRANTIES ARE DISCLAIMED TO THE FULLEST EXTENT PERMITTED BY LAW. THIS WARRANTY DOES NOT COVER CONSEQUENTIAL DAMAGES, LOSS OF TIME OR REVENUES, INCONVENIENCE, LOSS OF USE OF THE VEHICLE, DAMAGE TO THE VEHICLE OR COMPONENTS OF THE VEHICLE, ANY OTHER TYPE OF CONSEQUENTIAL DAMAGES, OR OTHER INCIDENTAL OR INDIRECT DAMAGES. HOTCHKIS' MAXIMUM LIABILITY UNDER THIS WARRANTY SHALL IN NO EVENT EXCEED THE PURCHASE PRICE OF THE PRODUCT. Some states do not allow limitations on how long an implied warranty lasts or the exclusion or limitation of incidental or consequential damages and in such states the above limitations or exclusions may not apply. This limited warranty gives the purchaser specific legal rights and the purchaser may have other rights that may vary from state to state.

Technical Information

Hotchkis Performance makes every effort to ensure that you are provided with the most accurate and up-to-date technical information. However, all technical information is approximate and may vary upon application. Additional suspension components may be needed in some applications, depending upon the make, model, engine and chassis of the vehicle. Hotchkis Performance is not responsible for any consequences resulting from manufacturer's technical mid-year changes. Hotchkis Performance products should only be installed by a qualified, licensed auto mechanic experienced in the installation of such products.

Warranty Claim Procedure:

The answer to ALL the following questions should be YES before making a warranty claim:

- Did you register the product at www.hotchkis.net or via the mail-in warranty card within 30 days of purchase?
- Is the product appropriate to your application?
- Did you carefully and thoroughly read the instructions provided along with the product?
- Do you have the original invoice or sales receipt?
- Is the return date within 36 months from the purchase date?
- Are you the original purchaser?
- Was the product properly installed by a qualified, licensed auto mechanic?
- Has the product been installed on the original vehicle on which it was installed at all times?
- Is the product unmodified and clean?
- Is the reason for return a legitimate product defect?

If the answer to all these questions is YES, please contact our Customer Service Department at (562) 907-7757. You will be given a Returned Goods Authorization Number (RGA) valid for 60 days. You will also be asked to ship the product prepaid to our facility. All shipments MUST be (i) prepaid, (ii) include the original invoice or sales receipt, (iii) show the RGA on the outside of the package and (iv) include your name, address, make and model of the vehicle, and a brief description of the claimed defect, including the circumstances under which the defect occurred. If the warranty claim is deemed valid then Hotchkis will estimate shipping costs to return the repaired or replacement part and contact you for payment. Hotchkis's Limited warranty requires that any repaired or replaced product will be returned to the sender excluding the cost of freight. Warranty related inquiries should be sent to the following address:

**HOTCHKIS PERFORMANCE, LLC
C/O CUSTOMER SERVICE
8633 Sorensen Avenue
SANTA FE SPRINGS, CA 90670**

Hotchkis Performance will not accept product returns without the RGA number, receipt and the information described above. C.O.D. or collect shipments will be refused. Once the returns are received at Hotchkis Performance, we will evaluate the products, verify the sales receipt, and investigate the warranty claim. Any repaired or replaced product will be returned to the sender.

Effective December 1, 2010. This return policy and limited warranty supersedes all previous policy and warranty statements. Policies and warranties are subject to change without notice. Hotchkis Performance is not responsible for printing errors.

HOTCHKIS **HOTCHKIS** **SPORT SUSPENSION**

2281
1978-1988 GM A/G Body
Extreme Sway Bar Kit

Thank you for your purchase from our new line of GM parts.

Please call us at (877) 4NO - ROLL if you have any questions regarding the service or installation of your Hotchkis products.

Before You Start:

Please read this entire instruction manual before starting. Being prepared with the right tools and procedures will aid in the ease of this installation.

This sway bar kit requires Hotchkis Trailing Arms (p/n 1301) to be installed beforehand. You will not be able to install this kit using stock trailing arms due to end link interference.

Front Bar Installation

1. Look carefully at the current installation.
2. This installation can be performed without removing the front wheels. Always use proper safety devices such as jack stands or lift jacks to properly support the vehicle.
3. Loosen front bushing retaining bolts, leave a few threads engaged to support the bar.
4. Remove the factory end link from the car.
5. Support or hold the center of bar and carefully remove front bushing bolts.
6. Remove factory bar from vehicle, taking note of the placement of the swaybar bushings.

7. Using the included white silicone grease, grease the inside of the urethane 1 7/16" in sway bar bushings. (The silicone grease can be cleaned up with WD40.)



8. Install the urethane bushings on the bar. Make sure you position the bushing so when the bar is installed in the vehicle, the split will face the front of the car.
9. Place the bushing's bracket over top the bushing.



10. Install the new swaybar into the car using the included Cap Screws on the new brackets. This step will take some manipulating, as the original car was designed for a very small sway bar. You will need a 1/4" or a 6mm Allen Driver Socket for this. Our swaybar set is a much larger diameter than stock bar, and our Heavy Duty sway bar bushings and brackets are larger as well. You might find it easier to slightly squeeze the brackets together in a vice to allow you to better align the bracket holes with the original factory holes. Using a ratchet or air impact, install the screws with a washer under each head. This does work very well, you just need to use some torque to install these bolts. Have patience with this step.

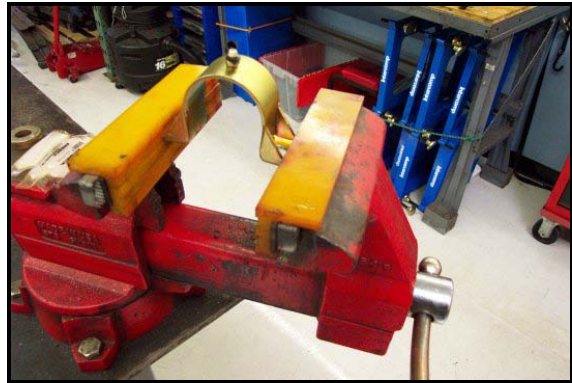

11. Install the new A-Arm endlinks using a ratchet and wrench.
12. Tighten end link nut to the point where the end link bushing's diameter is just larger than it's support washer.



Rear Bar Installation

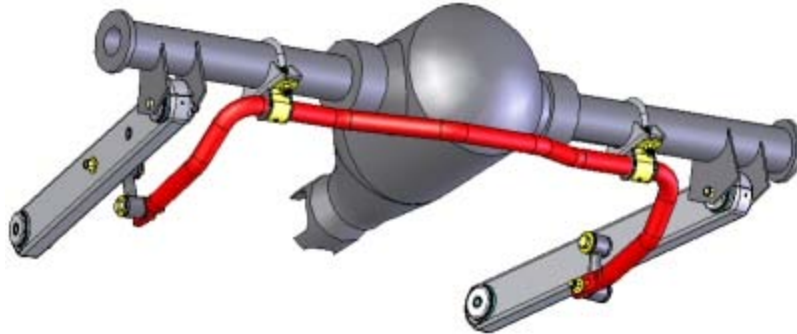

Before You Start:

This sway bar kit requires Hotchkis Trailing Arms (p/n 1302) to be installed beforehand. You will not be able to install this kit using stock trailing arms due to end link interference.

1. Raise Rear of the Vehicle

To properly install the rear sway bar you must have the rear suspension at ride height. Please use a 4-post lift or alignment rack to raise the vehicle. If these are not available, you may use floor ramps to gain access to the underside of the vehicle. Floor ramps can be found at most local auto parts stores.

2. Install Hotchkis End Links

Lube the polyurethane bushing surface on both dogbone end links. Look at your dogbone and notice that the bushing sleeves on each end have different inner diameters. The trailing arm bolt will use the small sleeve and the sway bar bolt will use the large hole. Use the 7/16" x 4" bolt to attach the end link to the trailing arm. The bolt should be pointing inboard. Use the 7/16" SAE washer (small) on the bolt head side and the 7/16" USS washer (larger) on the nut side. Do not fully tighten at this time.



3. Attach Sway Bar to the End Links

Orient the sway bar so that the Hotchkis sticker is right side up. At this time you can choose the stiffness setting by using the hole at the end for a softer setting or the 2nd hole from the end for a harder setting. Use the 1/2" x 3" bolt to attach the sway bar to the end link. The bolt should be pointing inboard. Use the 1/2" SAE washer (small) on the bolt head side and the 1/2" USS washer (larger) on the nut side. Do not fully tighten at this time.



4. Install Axle Brackets

First step is to install the provided stainless steel U-bolts. Each U-bolt will install a little inboard of the spring mount. You will have to unclip the brake line from the axle tab and carefully pull the brake line away from the axle tube to give enough clearance for the U-bolts.



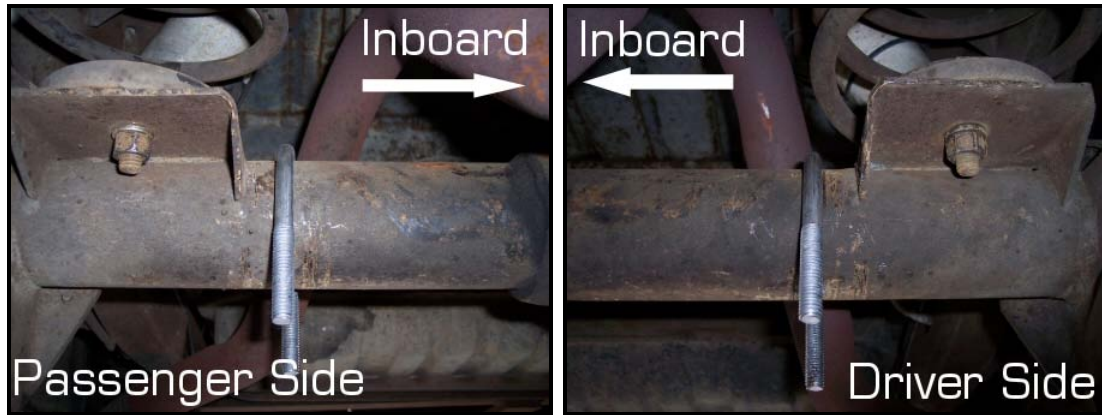

Next, apply the provided lube on the inside surface of the polyurethane bushings. Pop the bushings onto the sway bar. Slide the bushing brackets onto the bushings.

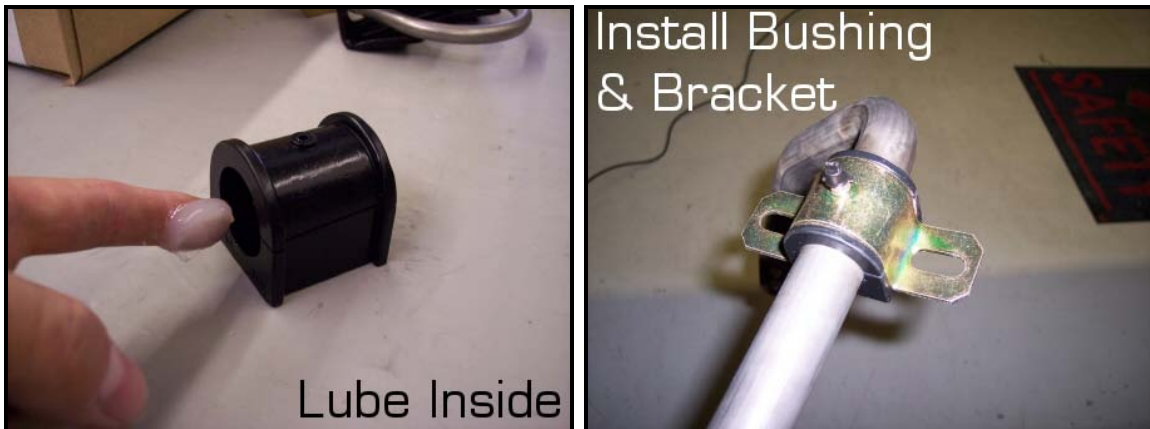

Apply a small amount of anti-seize to the threads of the U-bolts. Next position the axle bracket up against the axle tube. Raise the sway bar up to meet the axle bracket and allow the U-bolts to poke through the bushing bracket. Fasten the assembly together with the provided nut and washer. Do not fully tighten.



5. Position the Sway Bar

Since all of the hardware is still semi-loose, we can position the sway bar so that the end links are perpendicular to the trailing arm. Once the bar is positioned, fully tighten the axle bracket U-bolts. Then fully tighten the rest of the hardware. You are finished with this installation.

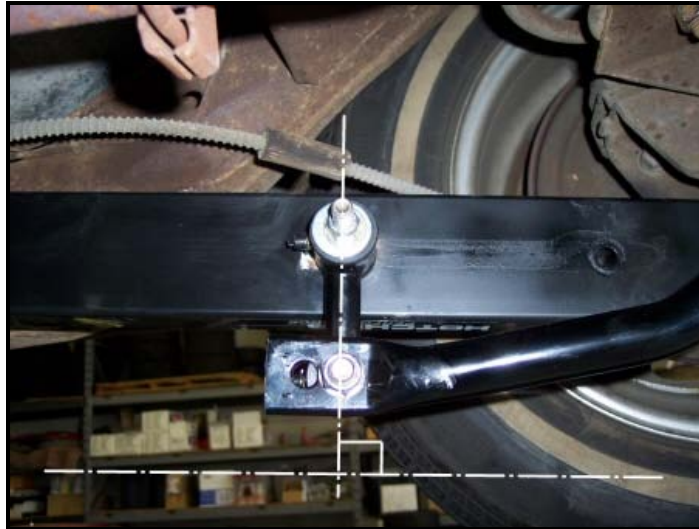

6. Optional Reinforcement

If the vehicle is going to be drag racing or road racing, it is recommended that you weld the axle brackets to the axle tubes. Sand off the paint on the mating edge of the axle bracket and axle tube. MIG weld a few beads on each side of the bracket. Finish it off with a little spray paint to keep it from rusting.

Hotchkis Performance LLC Return Policy & Limited Warranty

Effective December 1, 2010 all Hotchkis products must be registered to qualify for warranty at www.hotchkis.net or via the mail-in warranty card, included with the product, within 30 days of the original purchase date.

IMPORTANT: This warranty supersedes all other warranties included with this product.

Return Policy

We want you to be completely satisfied with your Hotchkis Performance product. For products, presenting signs of shipping damage please contact the freight carrier immediately. All our products are guaranteed to be free from manufacturer's defects. If your order arrives with a manufacture defect, please contact our Customer Service Department at (562) 907-7757. You will be assigned a Returned Goods Authorization Number (RGA). The package you return must show the RGA on the outside of the package, include the original invoice and be shipped prepaid to our facility. The product has to be unused and in its original packaging materials. Exchanges or refunds made after 30 days will be subject to a 20% restocking charge. **If you purchased your Hotchkis Performance product from an authorized dealer, you are still covered by this return policy. All returns however, should be made to your dealer, not to Hotchkis Performance directly.**

Limited Warranty

Hotchkis Performance offers a Limited Warranty against defects in materials and workmanship for the term of 36 months (3 years) from the date of purchase of this product. This Warranty only applies to the original retail purchaser who retains ownership of the vehicle on which the product was originally installed. If the product is determined to be defective, Hotchkis Performance will repair, replace or refund the purchase price of the defective product at Hotchkis Performance's sole discretion, which shall fully satisfy and discharge any and all warranty claims. Any repaired or replaced product will be returned to the sender excluding the cost of freight. **Products must be registered to qualify for warranty at www.hotchkis.net or via the mail-in warranty card, included with the product, within 30 days of the original purchase date.**

Exclusions from Warranty

Items offered but not manufactured by Hotchkis Performance are warranted according to the manufacturer's terms and are not covered by this limited warranty. Hotchkis Performance shall not be responsible for any labor, removal, installation, re-installation or maintenance costs. This warranty does not cover the cosmetic finish or plating of any product or any normal wear and tear to any product including, but not limited to bushings, brackets, end-links, hardware, steering components, shocks or springs. In addition, this warranty does not apply to any products that have been:

- **Improperly installed or installed by someone other than a qualified, licensed auto mechanic experienced in the installation and removal of suspension products;**
- **Improperly serviced, misused, or modified, altered or subjected to abuse, negligence, accident or collision;**
- **Installed in any vehicle that has been modified;**
- **Installed on any vehicle that has carried loads in excess of automobile manufacturer suggested weight limits; or**
- **Installed on any vehicle that has been subject to abnormal or excessive use, including rallying, racing, or racing-type activities or off-road use.**

Limitation of Warranty

This limited warranty is the entire and only warranty for the products and may not be modified or supplemented by any other person or company in any form. Any description of the products, by anyone, is for the sole purpose of identifying them and is not part of the basis of the bargain, and does not constitute a warranty that the products will conform to that description. The statements of any salesperson do not constitute part of this limited warranty and cannot be relied upon as a warranty.

THERE ARE NO WARRANTIES, EXPRESSED OR IMPLIED, INCLUDING ANY IMPLIED WARRANTIES OF MERCHANTABILITY OR FITNESS FOR A PARTICULAR PURPOSE, WHICH EXTEND BEYOND THE DESCRIPTION ON THE FACE HEREOF. ANY IMPLIED WARRANTIES ARE DISCLAIMED TO THE FULLEST EXTENT PERMITTED BY LAW. THIS WARRANTY DOES NOT COVER CONSEQUENTIAL DAMAGES, LOSS OF TIME OR REVENUES, INCONVENIENCE, LOSS OF USE OF THE VEHICLE, DAMAGE TO THE VEHICLE OR COMPONENTS OF THE VEHICLE, ANY OTHER TYPE OF CONSEQUENTIAL DAMAGES, OR OTHER INCIDENTAL OR INDIRECT DAMAGES. HOTCHKIS' MAXIMUM LIABILITY UNDER THIS WARRANTY SHALL IN NO EVENT EXCEED THE PURCHASE PRICE OF THE PRODUCT. Some states do not allow limitations on how long an implied warranty lasts or the exclusion or limitation of incidental or consequential damages and in such states the above limitations or exclusions may not apply. This limited warranty gives the purchaser specific legal rights and the purchaser may have other rights that may vary from state to state.

Technical Information

Hotchkis Performance makes every effort to ensure that you are provided with the most accurate and up-to-date technical information. However, all technical information is approximate and may vary upon application. Additional suspension components may be needed in some applications, depending upon the make, model, engine and chassis of the vehicle. Hotchkis Performance is not responsible for any consequences resulting from manufacturer's technical mid-year changes. Hotchkis Performance products should only be installed by a qualified, licensed auto mechanic experienced in the installation of such products.

Warranty Claim Procedure:

The answer to ALL the following questions should be YES before making a warranty claim:

- **Did you register the product at www.hotchkis.net or via the mail-in warranty card within 30 days of purchase?**
- **Is the product appropriate to your application?**
- **Did you carefully and thoroughly read the instructions provided along with the product?**
- **Do you have the original invoice or sales receipt?**
- **Is the return date within 36 months from the purchase date?**
- **Are you the original purchaser?**
- **Was the product properly installed by a qualified, licensed auto mechanic?**
- **Has the product been installed on the original vehicle on which it was installed at all times?**
- **Is the product unmodified and clean?**
- **Is the reason for return a legitimate product defect?**

If the answer to all these questions is YES, please contact our Customer Service Department at (562) 907-7757. You will be given a Returned Goods Authorization Number (RGA) valid for 60 days. You will also be asked to ship the product prepaid to our facility. All shipments MUST be (i) prepaid, (ii) include the original invoice or sales receipt, (iii) show the RGA on the outside of the package and (iv) include your name, address, make and model of the vehicle, and a brief description of the claimed defect, including the circumstances under which the defect occurred. If the warranty claim is deemed valid then Hotchkis will estimate shipping costs to return the repaired or replacement part and contact you for payment. Hotchkis's Limited warranty requires that any repaired or replaced product will be returned to the sender excluding the cost of freight. Warranty related inquires should be sent to the following address:

**HOTCHKIS PERFORMANCE, LLC
C/O CUSTOMER SERVICE
8633 Sorensen Avenue
SANTA FE SPRINGS, CA 90670**

Hotchkis Performance will not accept product returns without the RGA number, receipt and the information described above. C.O.D. or collect shipments will be refused. Once the returns are received at Hotchkis

Performance, we will evaluate the products, verify the sales receipt, and investigate the warranty claim. Any repaired or replaced product will be returned to the sender.

Effective December 1, 2010. This return policy and limited warranty supersedes all previous policy and warranty statements. Policies and warranties are subject to change without notice. Hotchkis Performance is not responsible for printing errors.