

# ROUGH COUNTRY

## SUSPENSION SYSTEMS®

### 2014-16 GM 1500 Denali Truck w/ Magneride 2" Leveling Kit

**Thank you for choosing Rough Country for all your suspension needs.**

Rough Country recommends a certified technician install this system. In addition to these instructions, professional knowledge of disassemble/reassembly procedures as well as post installation checks must be known. Attempts to install this system without this knowledge and expertise may jeopardize the integrity and/or operating safety of the vehicle.

Please read instructions before beginning installation. Check the kit hardware against the parts list on this page. Be sure you have all needed parts and know where they go. Also please review tools needed list and make sure you have needed tools.

#### PRODUCT USE INFORMATION

**⚠ WARNING** As a general rule, the taller a vehicle is, the easier it will roll. Seat belts and shoulder harnesses should be worn at all times. Avoid situations where a side rollover may occur.

Generally, braking performance and capability are decreased when larger/heavier tires and wheels are used. Take this into consideration while driving. Do not add, alter, or fabricate any factory or after-market parts to increase vehicle height over the intended height of the Rough Country product purchased. Mixing component brands is not recommended.

Rough Country makes no claims regarding lifting devices and excludes any and all implied claims. We will not be responsible for any product that is altered.

This suspension system was developed using a 285/70/17, tire with factory wheels. **Note** if wider tires are used, offset wheels will be required and trimming will be required.

If you have any questions concerning the design, function, and correct use of our products please contact us at 800-222-7023.

#### **⚠ NOTICE** NOTICE TO DEALER AND VEHICLE OWNER

Any vehicle equipped with any Rough Country product should have a Warning to Driver+decal installed on the inside of the windshield or on the vehicle's dash. The decal should act as a constant reminder for whoever is operating the vehicle of its unique handling characteristics.

**INSTALLING DEALER** - it is your responsibility to install the warning decal and forward these installation instructions on to the vehicle owner for review. These instructions should be kept in the vehicle for its service life.

#### **Tools Needed:**

10mm Socket  
18mm Wrench  
15mm Socket  
15mm Wrench  
17mm Wrench  
21mm Wrench  
7/32 Allen Wrench  
Flat Screwdriver  
Hammer



## INSTALLATION INSTRUCTIONS

1. Jack up the front of the vehicle and support the vehicle with jack stands, so that the front wheels are off the ground
2. Remove the front tires/wheels., using a 21mm deep well socket
3. Using a 18mm wrench loosen the upper strut bolts. It is not necessary to remove nuts. **See Photo 1.**
4. Place jack stand under the knuckle for support. Remove upper ball joint nut, using a 18mm wrench. Using a hammer hit the knuckle as shown to allow the ball joint to separate from the knuckle. **See Photo 2.** Do not allow the knuckle to pull out far enough that it pulls the shaft out of the differential.

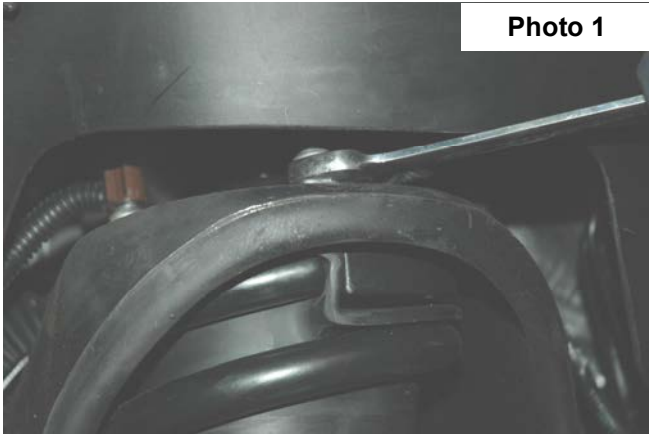

Photo 1

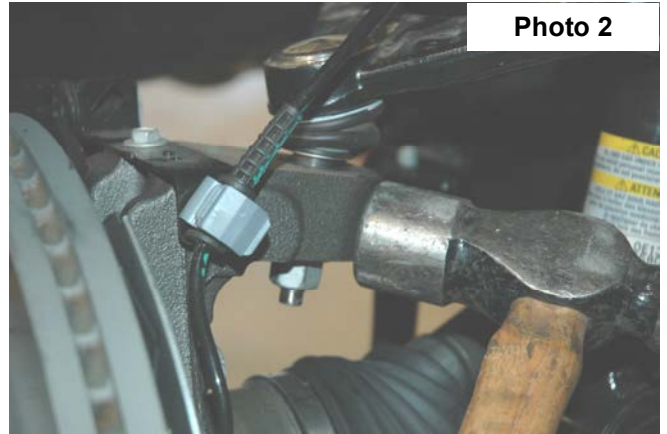

Photo 2

5. Using a 21mm wrench remove the nut from the steering linkage. Using a hammer hit on the side of the knuckle as shown, where the steering linkage is connected and remove from knuckle. Push linkage forward to make room for installation. Retain factory hardware. **See Photo 3.**
6. Remove the sway bar nut and bushings using a 15mm wrench, and 15mm socket. Retain factory hardware. **See Photo 4**

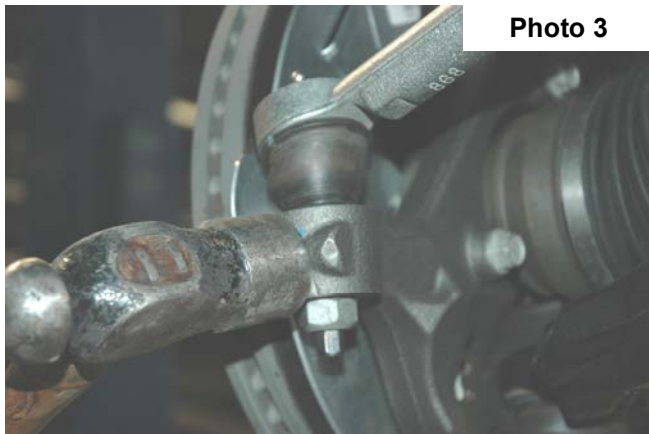

Photo 3

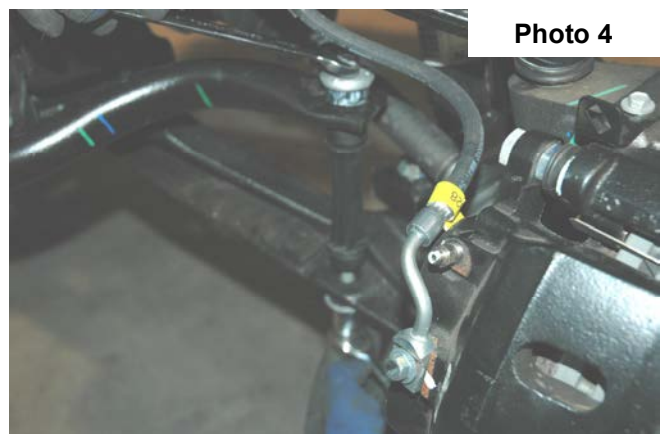

Photo 4

7. Using a 15mm wrench remove the bolts from the bottom strut mount. **See Photo 5**
8. Remove the bolt clips from the bottom of the strut using a flat screw driver. **See Photo 6**

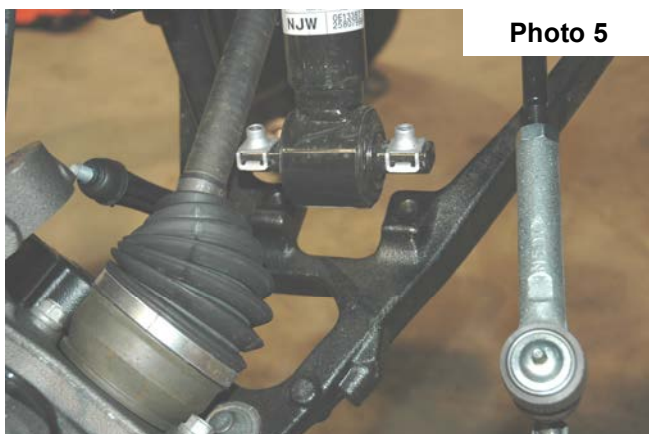
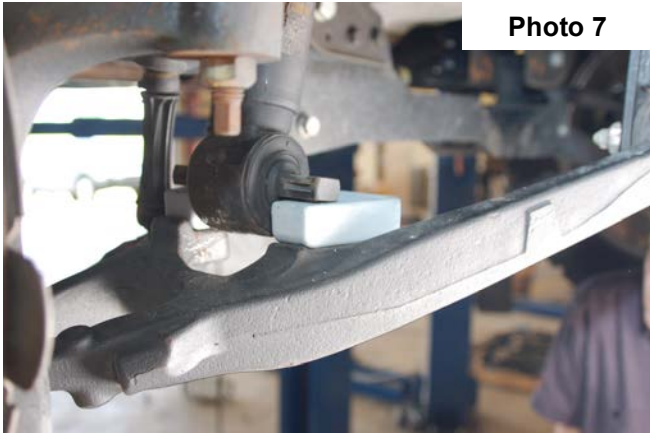

Photo 5



Photo 6

9. Place strut spacer under the lower strut mount and align holes. **See Photo 7.**
10. Install the new 10mm bolts, washers and nuts provided in the kit. Install bolts with the head going down as shown in **Photo 8.** Tighten to 30-35 ft/lbs. **Do not over-tighten the bolts.** You may have to move the knuckle to one side to allow room to install the bolt by the axle shaft.

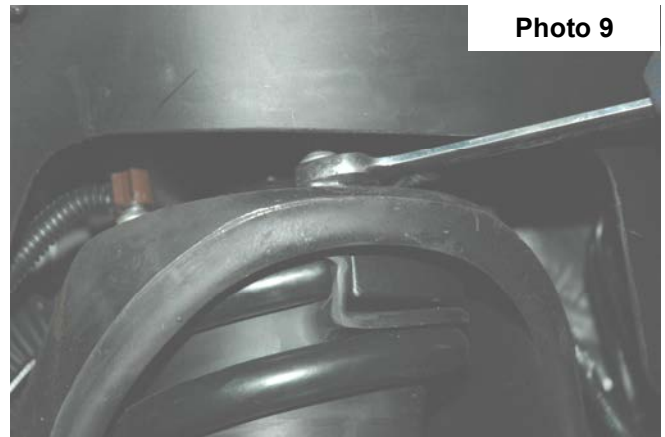

**Photo 7**

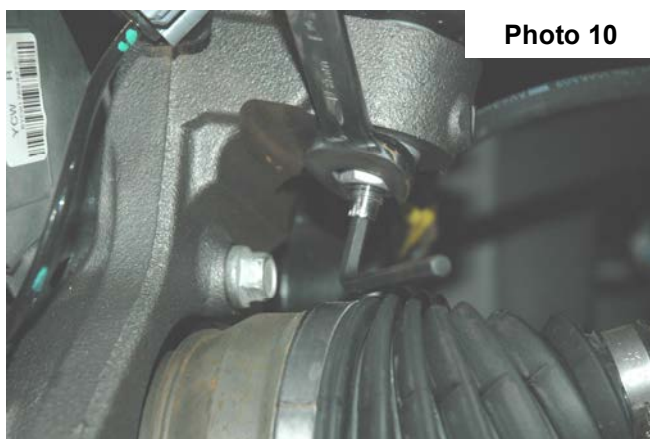

**Photo 8**

11. Tighten the bolt using a 17mm wrench, and a 16mm wrench for the nut.
12. Using a 18mm wrench tighten the upper strut nuts, torque to factory specs **See Photo 9.**
13. Raise the lower control arm and connect the upper ball joint on the upper control arm to the spindle. Using a 18mm wrench, torque to manufacturer specs. If ball joint turns while tightening, use a 7/32" allen wrench to hold the ball joint. **See Photo 10.**
14. Reinstall the steering linkage nut using a 21mm wrench. If ball joint turns while tightening, use a 10mm wrench to hold the bottom of the tie rod.
15. Using the supplied 6mm bolt and washer, attach the Magneride relocation bracket to the upper control arm. Then attach the linkage to the relocation bracket with the 6mm locknut. Tighten using a 10mm socket **See Photo 11.**
16. Repeat steps 3-15 on opposite side of vehicle
17. Using a 15mm wrench, reinstall sway bar bushings and nut using factory hardware. Torque to factory specs.
18. Install the wheels / tires, using a 21mm deep well socket.
18. Jack up the vehicle and remove the jack stands. Lower the vehicle to the floor and torque all bolts to factory specifications.



**Photo 9**



**Photo 10**

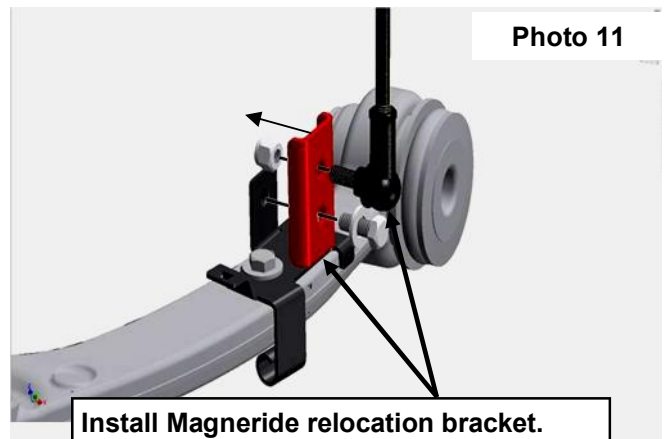

**Photo 11**

19. Using an certified alignment professional, have an alignment done to factory specifications.



## POST INSTALLATION

1. Check all fasteners for proper torque. Check to ensure there is adequate clearance between all rotating, mobile, fixed and heated members. Check steering for interference and proper working order. Test brake system.
2. Perform steering sweep. The distance between the tire sidewall and the brake hose must be checked closely. Cycle the steering from full turn to full turn to check for clearance. Failure to perform inspections may result in component failure.
3. Re torque all fasteners after 500 miles. Visually inspect components and re torque fasteners during routine vehicle service.
4. Readjust headlights to proper settings.

## MAINTENANCE INFORMATION

It is the ultimate buyers responsibility to have all bolts/nuts checked for tightness after the first 500 miles and then every 1000 miles. Wheel alignment steering system, suspension and driveline systems must be inspected by a qualified professional mechanic at least every 3000 miles.

## KIT CONTENTS



### Kit Contents:

2-Front Strut Extensions

1-Kit Bag that includes

4-10mm x 80mm Bolts

4-10mm x 90mm Bolts

2. Magnaride Relocation Brkts

8-SAE Flat washers

2-6mm x 16mm Bolts

2-6mm Nylock Nuts

2-6mm Flat Washers

4-10mm Nylock Nuts

## Thank you for purchasing a Rough Country Suspension System.

By purchasing any item sold by Rough Country, LLC, the buyer expressly warrants that he/she is in compliance with all applicable Federal, State, and Local laws and regulations regarding the purchase, ownership, and use of the item. It shall be the buyers responsibility to comply with all Federal, State and Local laws governing the sales of any items listed, illustrated or sold. The buyer expressly agrees to indemnify and hold harmless Rough Country, LLC for all claims resulting directly or indirectly from the purchase, ownership, or use of the items.

