

TOYOTA Tundra 2014-17 Mesh Grille

Thank you for choosing Rough Country for all your vehicle needs.

Please read instructions before beginning installation. Check the kit hardware against the kit contents shown below. Be sure you have all needed parts and know where they go.

If question exist, please call us @1-800-222-7023. We will be happy to answer any questions concerning this product.

Check all fasteners for proper torque. Check to ensure for adequate clearance between all components.

Periodically check all hardware for tightness.

70222 KIT CONTENTS:

- Mesh Grille Trim Ring (x1)
- Mesh Grille (x1)
- Top Grille Support (x1)
- Left Side Grille Bracket (x1)
- Right Side Grille Bracket (x1)
- Grille Mounting Brackets (x9)

70222BAG:

- (9) #8x1/2 Button Head Allen Bolts
- (9) #8 Lock Nuts
- (11) 1/4-20x5/8 Button Head Allen Bolts
- (20) 1/4-20x1/2 Button Head Allen Bolts
- (31) 1/4-20 Nylock Nuts

70223 KIT CONTENTS:

- Mesh Grille Trim Ring (x1)
- Mesh Grille (x1)
- Top Grille Support (x1)
- Left Side Grille Bracket (x1)
- Right Side Grille Bracket (x1)
- Grille Mounting Brackets (x9)
- 30" Dual Row LED Grille Light Mounts (x2)

70223BAG:

- (9) #8x1/2 Button Head Allen Bolt
- (9) #8 Lock Nuts
- (13) 1/4-20x5/8 Button Head Allen Bolt
- (29) 1/4-20x1/2 Button Head Allen Bolt
- (42) 1/4-20 Nylock Nuts
- 30" Dual Row Curved LED (x1)

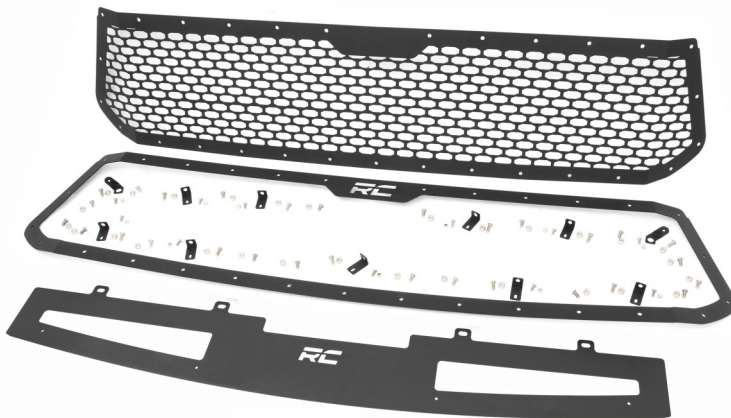

70222

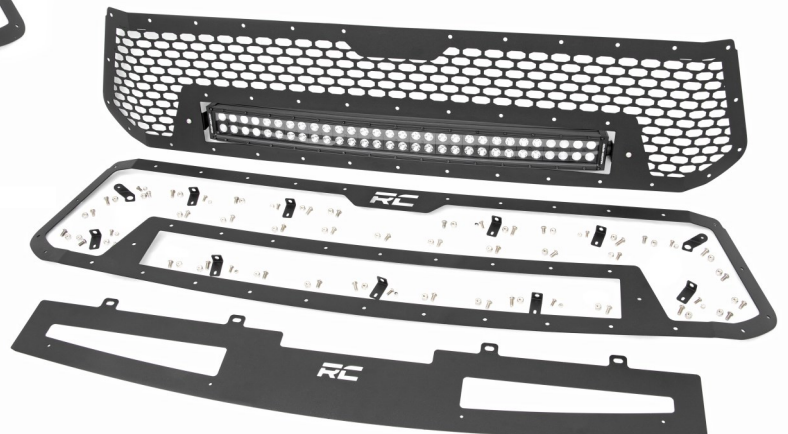

70223

TOOLS NEEDED:

- Auto Trim Puller
- 10mm Socket
- 7/16 Wrench or Socket
- Philips Screw Driver
- Drill Motor
- 3/16" Drill
- 3/32 Allen Wrench
- 5/32 Allen Wrench
- (x2) Flat Pry Tools
- Permanent Marker
- Tape Measure



Left Side Grille Bracket (x1) Right Side Grille Bracket (x1) Grille Mounting Brackets (x9)



30" Dual Row LED Grille Light Mounts (x2)



Top Grille Support (x1)

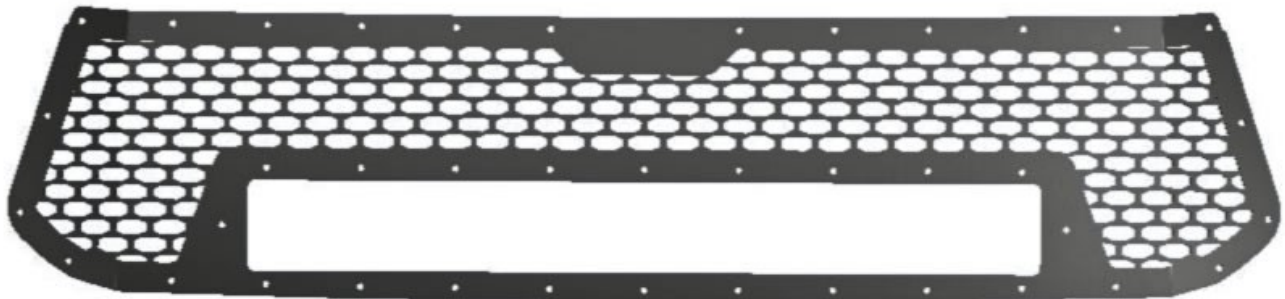

Mesh Grille, Shown With 30" Dual Row LED Mesh Grille (x1)



Mesh Grille Trim Ring, Shown with 30" Dual Row LED Trim Ring (x1)

INSTALLATION INSTRUCTIONS

1. Remove the 2 push pins, one on each side of the top of the grille using a auto trim puller. **See Photo 1.**
2. Remove the 4 screws in the top of the grille connecting to the radiator support using a 10mm socket to remove. **See Photo 2.** Save hardware for later use.

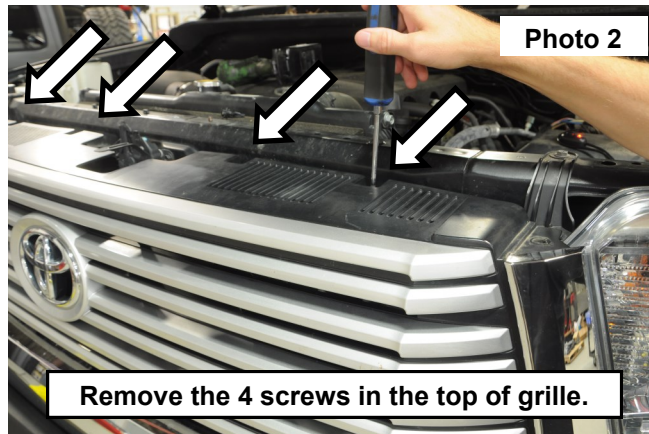
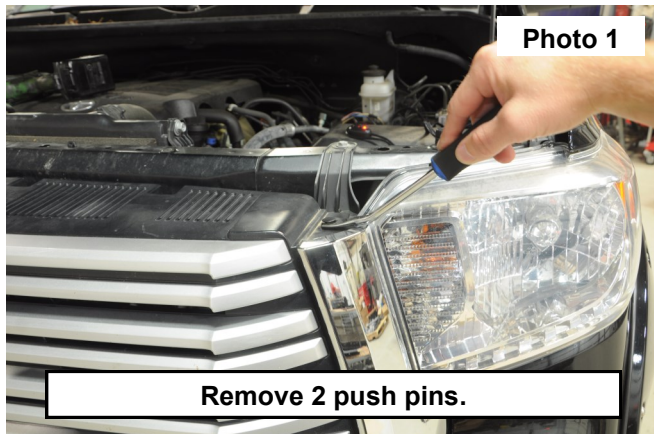

3. Pull straight out on the grille shell to unseat the clips securing the grille to the radiator support. **See Photo 3.**
4. With the grille laid face down. Remove the 2 Philips screws on each side of the grille securing the outer shell to the inner structure using a Philips screw driver. **See Photo 4.** Save hardware for later use.

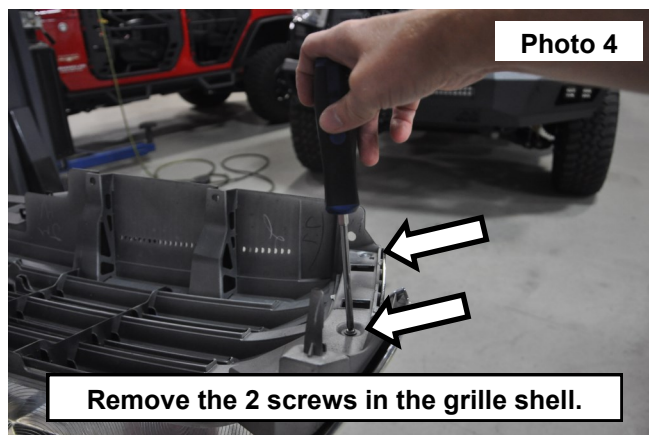

5. Removing the outer grille shell from the inner structure.
6. Approximately 13 clips are holding the 2 parts together, release each clip by pushing in the center tab. 2 or more pry tools may need to be used at the same time to help release the shell from the inner structure. **See Photos 5 and 6.**
7. Once the inner structure has been removed, set inner aside as this will not be reused. The lower outer shell will be fitted with the new grille.

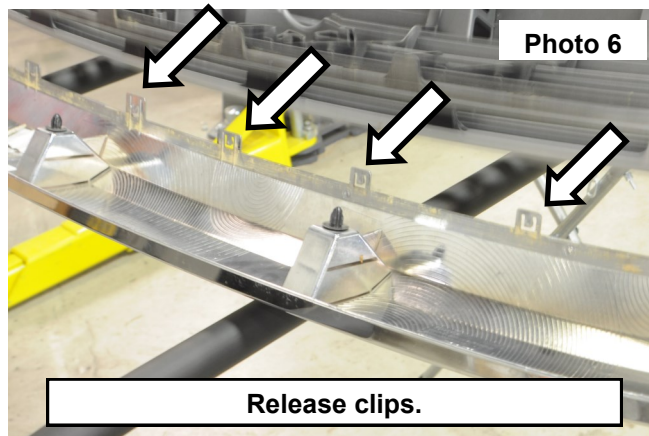
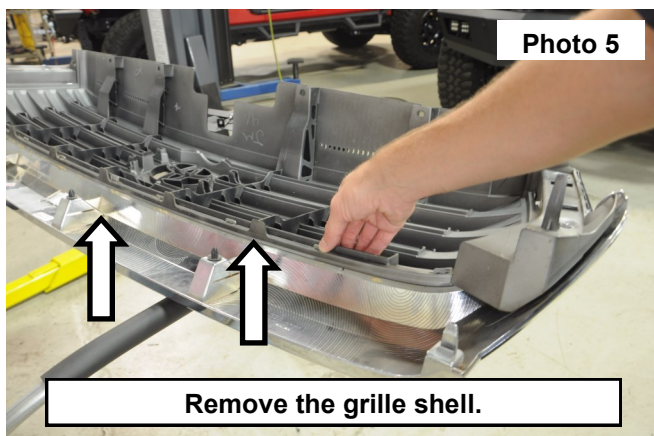

8. Using a tape measure locate and mark the center of the bottom of the grille shell. **See Photo 7.**
9. Locate the 9 grille mount brackets. **See Photo 8.**

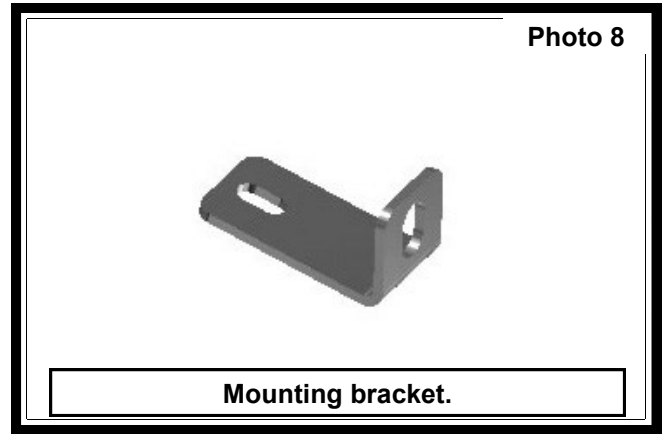
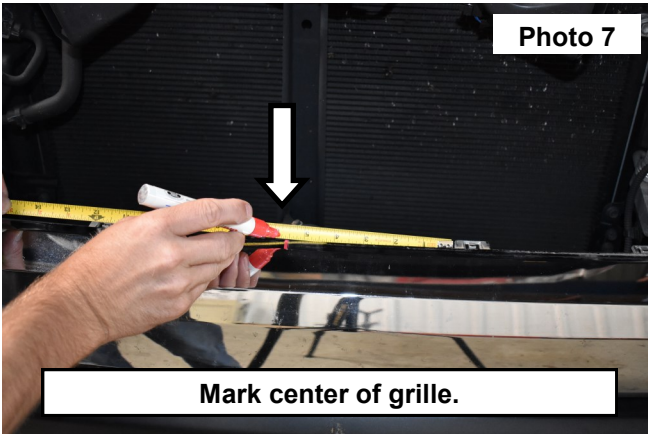

10. Place one of the grille mounting brackets onto the line drawn in the center of the grille shell.
11. Find the center of the slot in the bracket, drill a hole into the grille shell, use a 3/16" drill. **See Photo 9.**
12. Install the grille mesh and the trim ring together.
13. Install the 5 grille mounting brackets on the bottom of the grille. Starting in the bottom center of the grille, install bracket using a 1/4-20 x 5/8 SS button head bolt and a 1/4-20 Nylock nut. **Do not tighten at this time. See Photo 10. NOTE: Tall side stands up.**

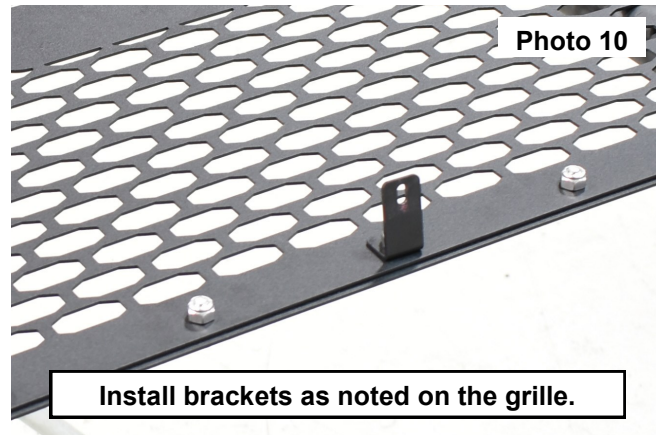
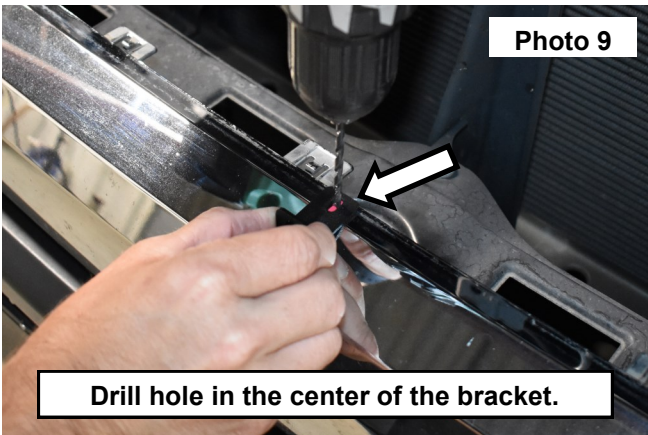

14. Install the next bracket from the center, skip 2 holes to the right and the left. Install the grille mounting brackets using the supplied 1/4-20 x 5/8 SS button head bolts and 1/4-20 Nylock SS nut. **Do not tighten at this time.**
15. Install the next grille mounting brackets, skip one hole and install brackets using a 1/4-20 x 5/8 SS button head bolts and 1/4-20 Nylock SS nut. **Do not tighten at this time.**
16. Install the 4 top mounting brackets. Skip one hole by the RC cover plate to the right and the left, install brackets using a 1/4-20 x 5/8 SS button head bolts and 1/4-20 Nylock SS nut. **Do not tighten at this time.**
17. Install the outer brackets. Skip 2 holes and install brackets using a 1/4-20 x 5/8 SS button head bolts and 1/4-20 Nylock SS nut. **Do not tighten at this time.**
18. Install the 1/4-20 x 1/2 SS button head bolts and 1/4-20 Nylock SS nuts in all of the in between holes. Tighten using a 5/32 allen wrench and a 7/16. **Turn on the nut, do not turn the head of the bolt.**
19. Steps 14-18 refer to **Photo 11.**

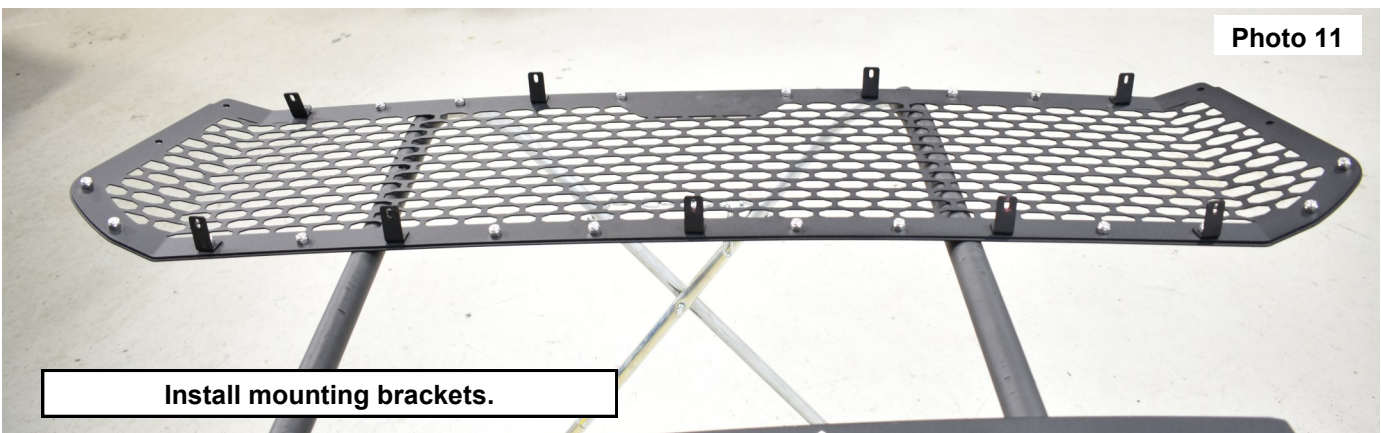

20. Install the grille in the shell. Align the drilled hole in the center of the grille shell, with the bottom bracket installed on the mesh grille. **You may have to bend the mesh grille to follow the lines of the factory grille trim, as the mesh grille is shipped as flat pieces.** Install the #8x1/2 bolt and nut in the center mount. **See Photo 12.** Tighten using a 3/32 allen wrench and a 7/16 wrench. Do not over tighten.
21. Install the 4 remaining brackets.
22. Align one bracket up at the edge of the grille shell, mark the center of the slot and drill a hole, use a 3/16" drill. **See Photo 13-14.**

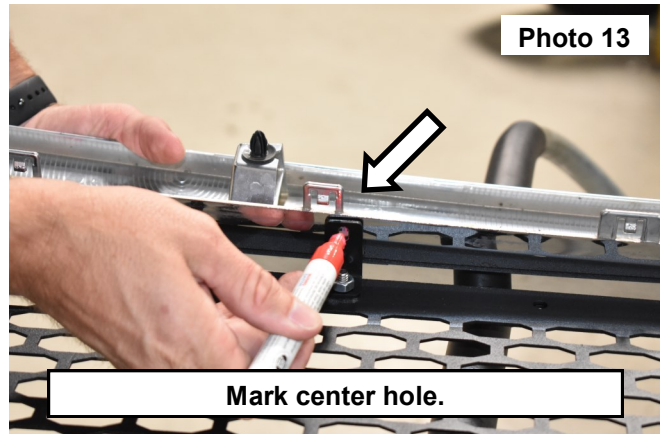
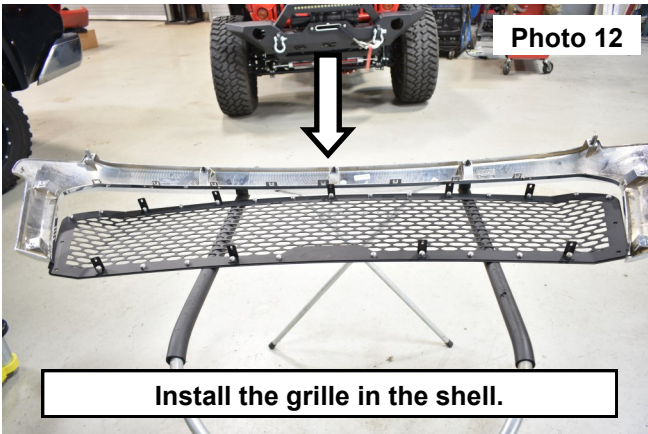

23. Install the #8x1/2 bolt and #8 lock nuts in the 4 remaining mounts. Tighten using a 3/32 allen and a 7/16 wrench. **See Photo 15.** Do not over tighten.

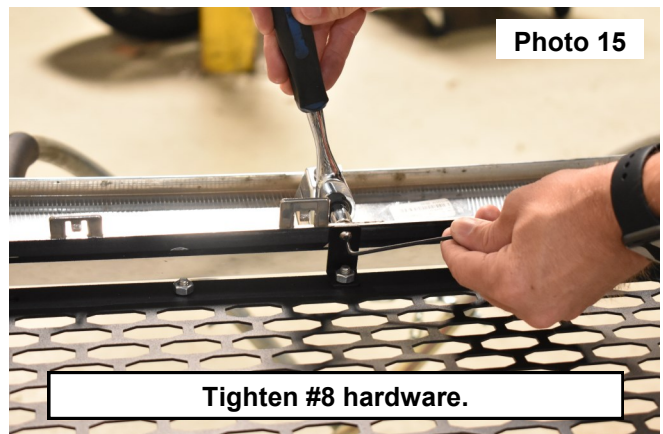
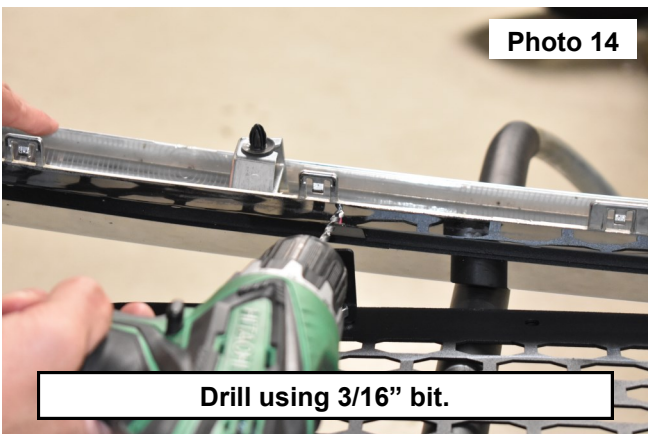

24. Locate the right side grille bracket. **See Photo 16.**
25. Install the right side grille bracket using the OE hardware, tighten using a Philips screw driver. **See Photo 17.**

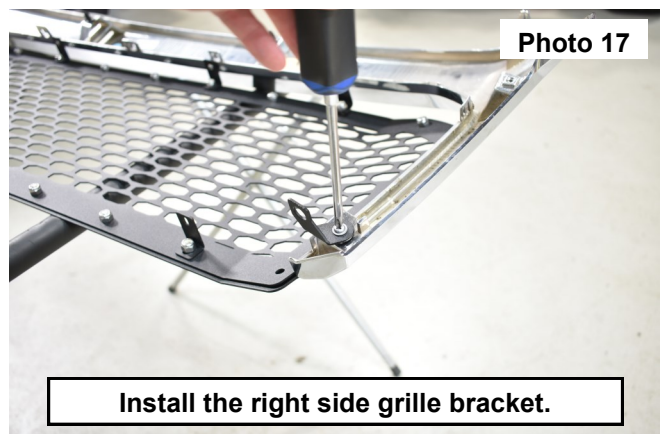
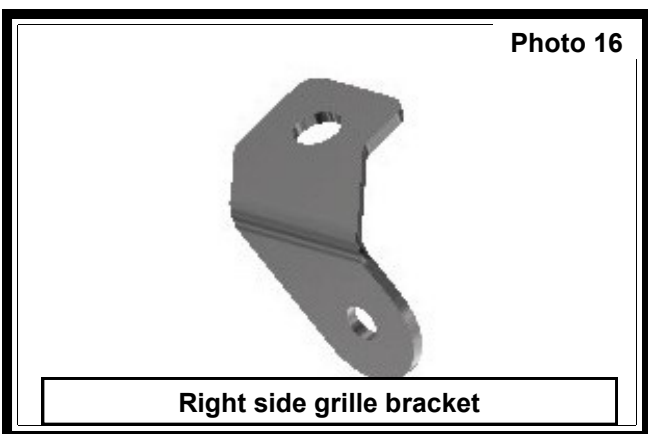

26. Locate the left side grille bracket. **See Photo 18.**

27. Install the left side grille bracket using the OE hardware. Tighten using a Philips screw driver. **See Photo 19.**

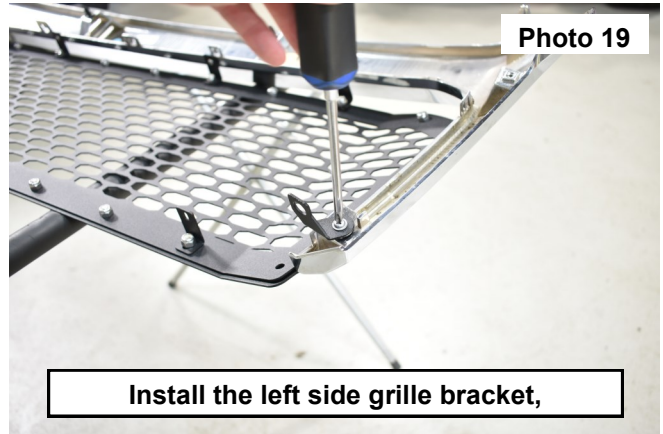
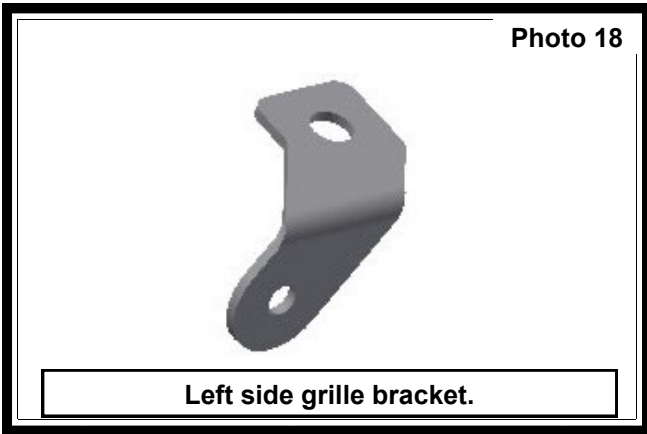

28. **If not installing led light skip to step 33.** Install the mesh grille with a 30" LED light, clip the wiring harness to the LED light, install the grille and adjust the LED light to the desired look.

29. Locate the (2) 30" LED light bar brackets, supplied with the grille. Using the supplied hardware install the brackets on each end of the LED light. **See Photo 20.** Do not tighten at this time.

30. Install the light bar onto the grille using the 1/4-20x5/8 SS button head bolts and a 1/4-20 Nylock nut. Use a 5/32 allen wrench on the bolt and a 7/16 wrench on the nut. **Turn on the nut, do not turn the head of the bolt.** **See Photo 21.**

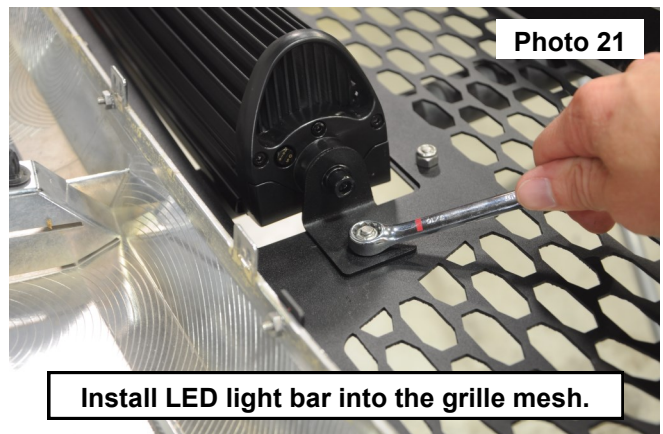
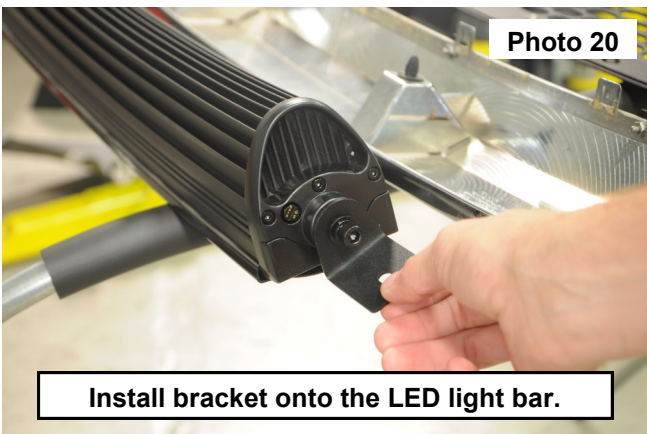

31. Snug the bolts in the light bar, the angle of the light will need to be set when installed on the vehicle. **See Photo 22.**

32. Install the wiring harness using the instruction sheets that corresponds with that kit, connect the harness to the LED light bar installed in the grille.

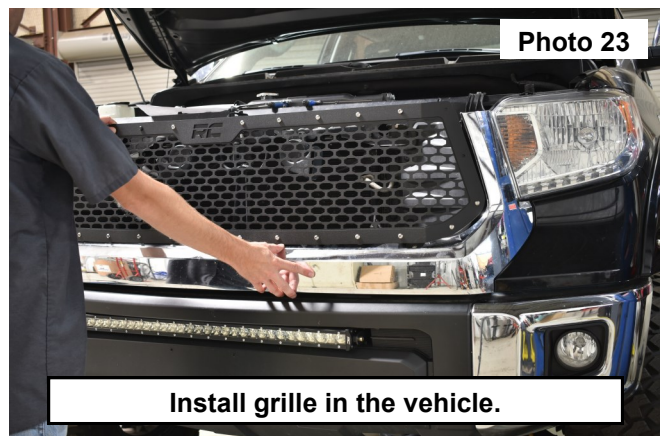
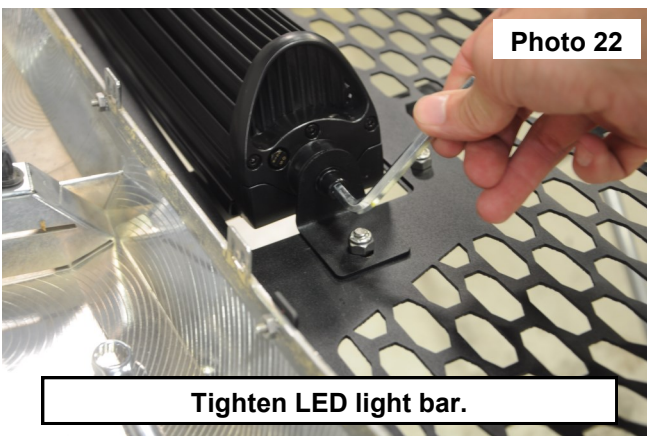

33. Install the grille, pressing the clips in the lower shell back into the radiator support. **See Photo 23.**
34. Tighten all of the 1/4-20x1/2 and 1/4-20x5/8 bolts in the grille and the brackets using a 5/32 allen wrench on the bolts and a 7/16 on the nut wrench. **Turn on the nut, do not turn the head of the bolt.** **See Photo 24.**
35. Set the LED light bar to the desired angle, tighten the bolts with the supplied tools in the kit.
36. Install the top grille support using the #8x1/2 bolts and #8 lock nuts and tighten using a 3/32 allen wrench and a 7/16 wrench to tighten. **See Photo 25.**



37. Install the (4) OE bolts in the rear of the top grille support. Tighten using a 10mm socket. **See Photo 26.**
38. Install a 1/4-20x5/8 bolt and nut in the right and left grille brackets. Tighten using a 5/32 allen wrench on the bolt and a 7/16 wrench on the nut. **See Photo 27.** Do not over tighten in the plastic grille support.

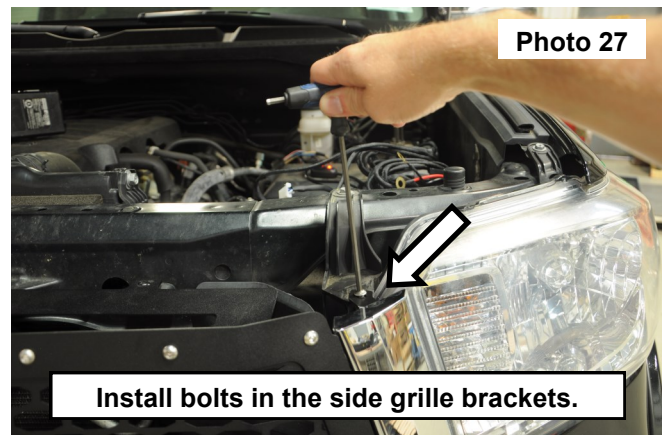

39. Recheck all hardware, wiring and angle of the 30" LED light. **See Photo 28.**

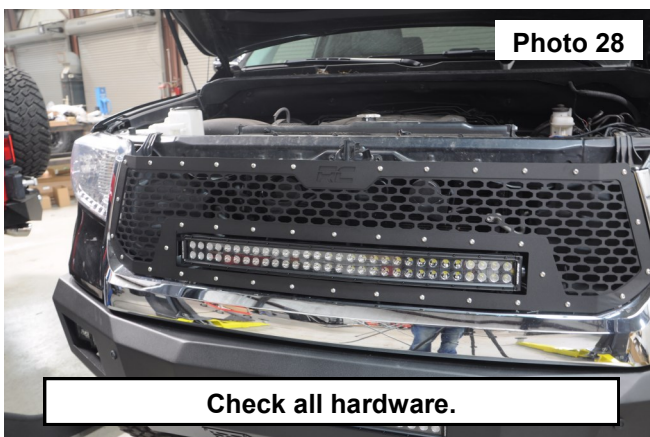



Torque Specs:

Size	Grade 5	Grade 8	Size	Class 8.8	Class 10.9
5/16"	15 ft/lbs	20ft/lbs	6MM	5ft/lbs	9ft/lbs
3/8"	30 ft/lbs	35ft/lbs	8MM	18ft/lbs	23ft/lbs
7/16"	45 ft/lbs	60ft/lbs	10MM	32ft/lbs	45ft/lbs
1/2"	65 ft/lbs	90ft/lbs	12MM	55ft/lbs	75ft/lbs
9/16"	95 ft/lbs	130ft/lbs	14MM	85ft/lbs	120ft/lbs
5/8"	135ft/lbs	175ft/lbs	16MM	130ft/lbs	165ft/lbs

By purchasing any item sold by Rough Country, LLC, the buyer expressly warrants that he/she is in compliance with all applicable , State, and Local laws and regulations regarding the purchase, ownership, and use of the item. It shall be the buyers responsibility to comply with all Federal, State and Local laws governing the sales of any items listed, illustrated or sold. The buyer expressly agrees to indemnify and hold harmless Rough Country, LLC for all claims resulting directly or indirectly from the purchase, ownership, or use of the items.

