



## 2018 Jeep JL Spare Tire Carrier Delete

Thank you for choosing Rough Country for all your vehicle needs.

Please read instructions before beginning installation. Check the kit hardware against the kit contents shown below. Be sure you have all needed parts and know where they go.

If question exist, please call us @1-800-222-7023. We will be happy to answer any questions concerning this product.

Check all fasteners for proper torque. Check to ensure for adequate clearance between all components.

Periodically check all hardware for tightness.

### KIT CONTENTS:

- 1-Brake Light Bracket
- 1-Brake Light/Camera Mount
- 1-License Plate Mount
- 6" LED Light Mount
- 8" LED Light Mount

### TOOLS NEEDED:

- Wire Cutter
- Wire Stripper
- Wire Crimper
- Ratchet
- 4mm Allen Wrench
- 5mm Allen Wrench
- Weather Proof Tape
- 3/16 Wrench
- T8 torx
- T20 Torx
- T25 Torx
- T40 Torx
- 19MM Socket
- 13MM Socket
- Philips Screw Driver
- 10mm wrench and socket

### HARDWARE INCLUDED:

- M6-1.0 x 14MM BUTTON HEAD x8
- 6MM-1.0 NYLOCK NUT x8
- 8MM-1.25 X 30MM SHCS x4
- 22-24ga Butt Connector x4
- BLACK LED TAG LIGHT-72" x1
- BLACK LED TAG LIGHT-17" x1
- #3-48 X 1IN PAN HEAD SCREW x3
- #3-48 MACHINE SCREW NUT x3
- Camera Mount Sleeves x3
- 1/2" Plug x6

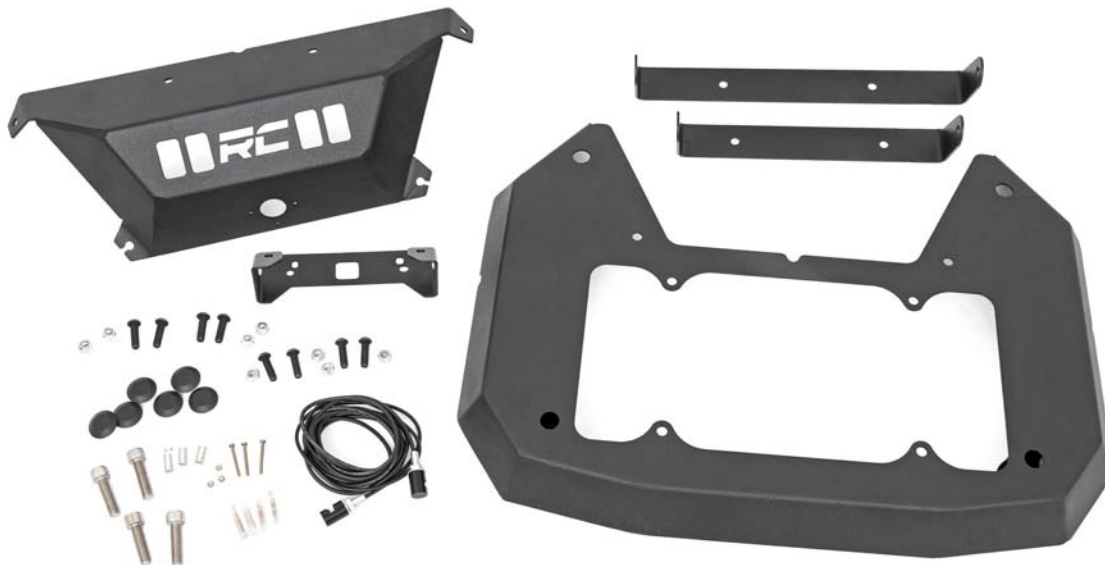

### Torque Specs:

Size	Grade 5	Grade 8	Size	Class 8.8	Class 10.9
5/16"	15 ft/lbs	20ft/lbs	6MM	5ft/lbs	9ft/lbs
3/8"	30 ft/lbs	35ft/lbs	8MM	18ft/lbs	23ft/lbs
7/16"	45 ft/lbs	60ft/lbs	10MM	32ft/lbs	45ft/lbs
1/2"	65 ft/lbs	90ft/lbs	12MM	55ft/lbs	75ft/lbs
9/16"	95 ft/lbs	130ft/lbs	14MM	85ft/lbs	120ft/lbs
5/8"	135ft/lbs	175ft/lbs	16MM	130ft/lbs	165ft/lbs
3/4"	185ft/lbs	280ft/lbs	18MM	170ft/lbs	240ft/lbs



## INSTALLATION INSTRUCTONS

1. Remove the 7 bolts from the brake light housing, then separate the housing, using a T20 torx . **See Photo 1.**
2. Remove the 2 bolts from brake light in the housing, using a T20 torx, save hardware for reuse. **See Photo 2.**

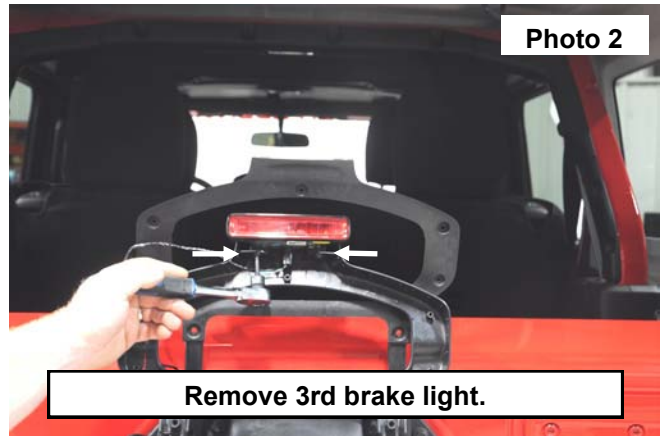
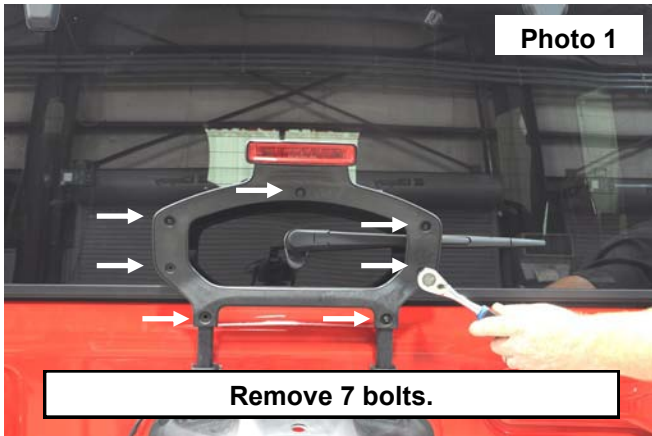

3. Remove the brake light from housing, unplug and set aside for reuse. **See Photo 3.**
4. Remove the 2 bolts holding the camera and lug stud bracket to the carrier, using a T20 torx. **See Photo 4.**

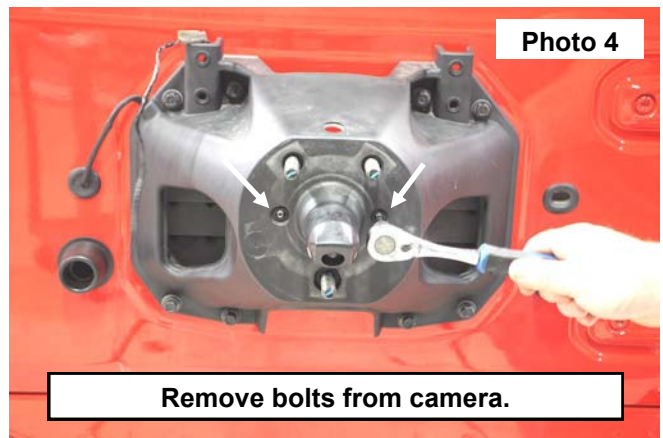
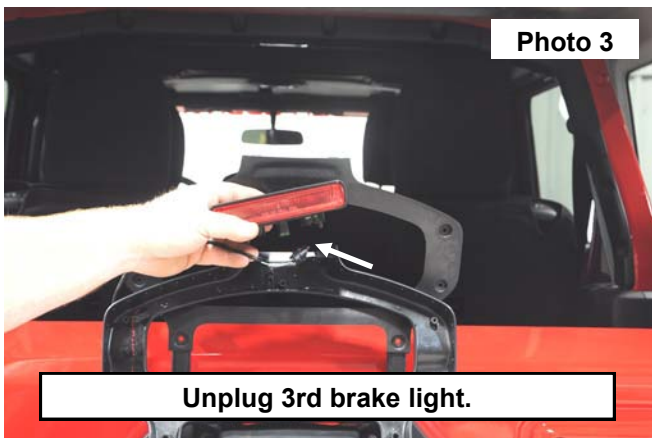

5. Remove the 8 bolts in the carrier, remove the brake light mount an wiring from the mount, set carrier and light mount a side. **use care removing the brake light wiring from the carrier, do not to let the camera hang by the wires, use a 13mm socket. See Photo 5.**
6. Remove the 3 screws from the camera, use a T8 torx. **See Photos 6.**

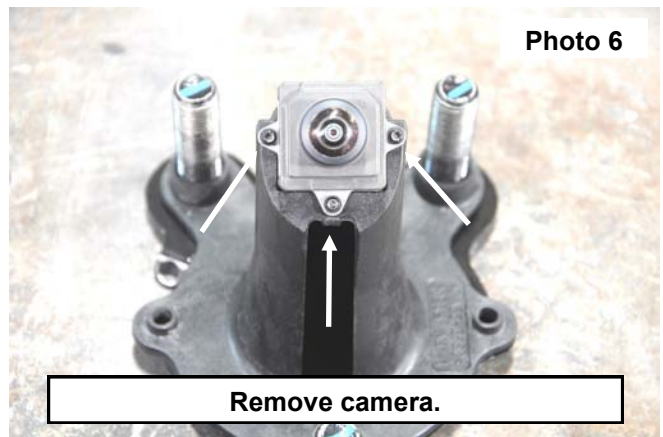
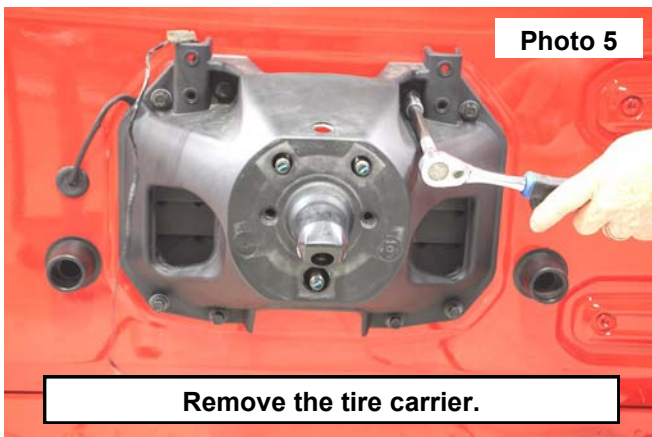

7. Remove the camera from the housing and unplug, set aside for reuse. **See photo 7.**
8. Once the carrier is removed clean the surface of the door. **See Photo 8.**



9. Install the light housing on top of the license plate mount. **See Photo 9.**
10. Use (2) M6-1.0x14 bolts and nuts in the top 2 holes of the light housing and the license plate mount. Use a 4mm allen and a 10mm wrench to tighten. **See Photo 10.**

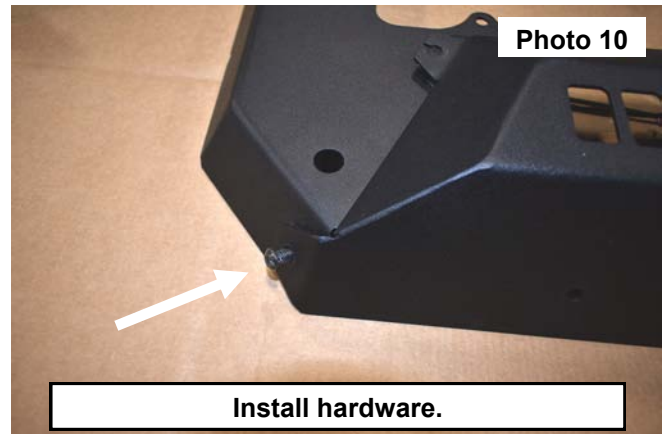

11. Install the license plate light wire stud, use the supplied washer and nut, adjust the light so that it faces the license plate opening, tighten using a 10mm wrench. **See Photos 11-12.**

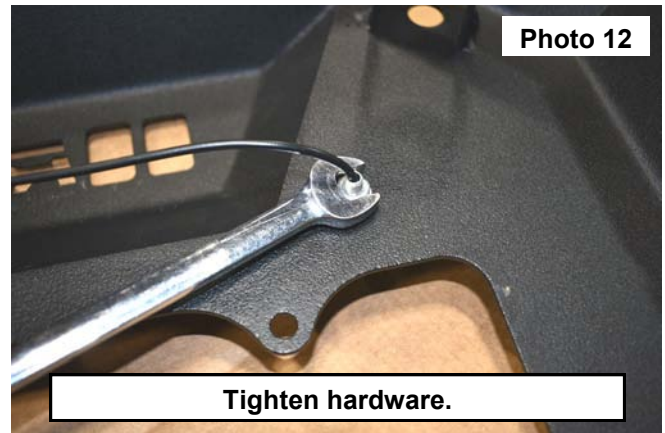



12. Splice the license plate wires together, use 2 of the supplied 22-24 ga. connectors. Apply heat to the connectors to activate the heat shrink and internal glue. **See Photo 13. NOTE : Do not over heat.**
13. Install the (3) #3-48 X 1IN Screws, (3) camera sleeves, secure the license plate wire under the bottom sleeve. **See Photo 14.**

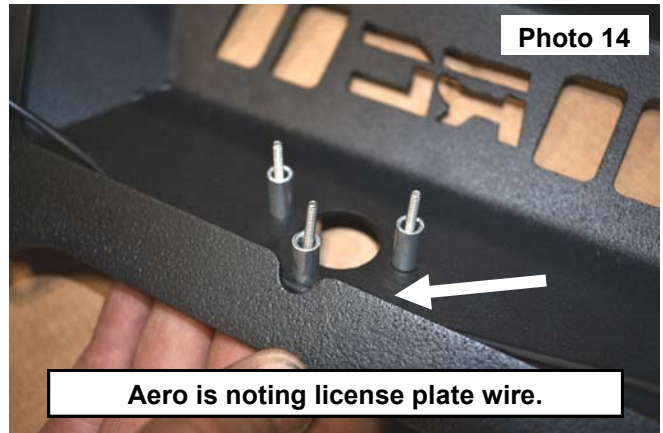
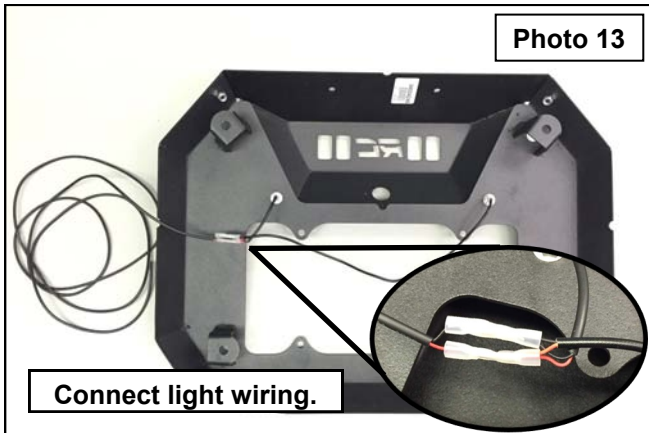

14. Install the camera and the (3) #3-48 nuts, tighten camera hardware using a Philips screw driver to hold the screws and tighten using the 3/16 wrench. **See Photo 15-16.** Do not over tighten.

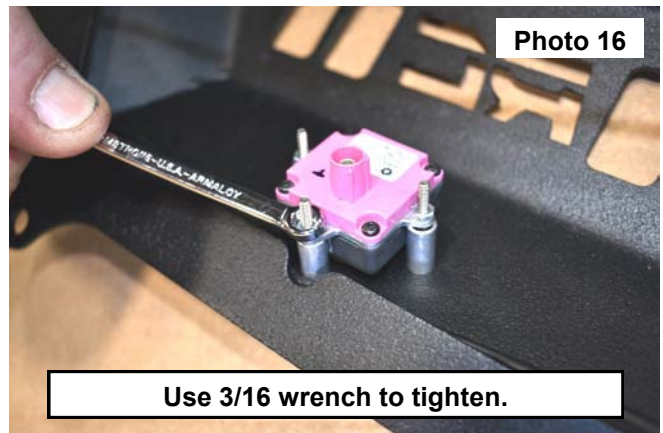

15. Install the 3rd brake light on to the bracket, using the OE hardware, tighten using a T25 torx. **See Photo 17.**
16. Install the 3rd brake light in the back of the spare tire delete facing outward, if installing a 6" or 8" single row light, install the M6-1.0 x 14MM bolts through the light bracket, spare tire delete and the 3rd brake light mount secure using (2) M6-1.0 nylock nuts. Tighten using a 4mm allen and a 11mm wrench. **See Photo 18.**

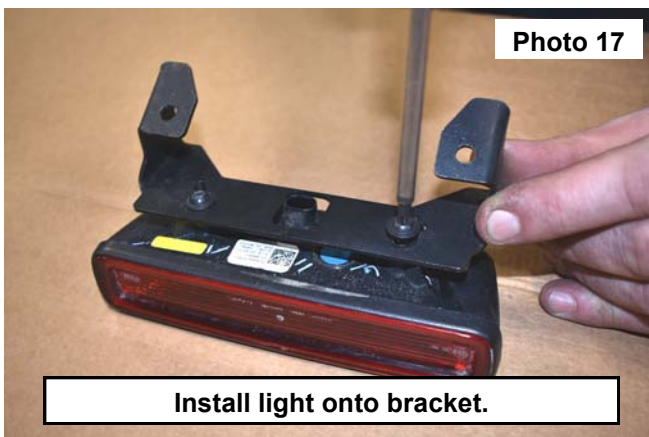

17. If using a 6" or 8" single row light, connect the wiring harness to the jeep, install the light onto the light mount on the spare tire delete using the hardware supplied in the light bar kit, snug the bolts to hold in place. **See Photo 19.**
18. Install the license plate facing outward from the spare tire delete, use (4) M6-1.0 x 14MM Button head allen bolts and nuts, tighten using a 4mm allen and a 10mm wrench. **See Photo 20.**

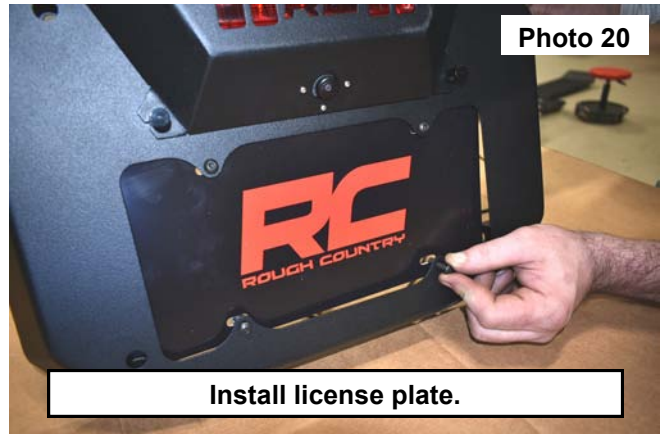
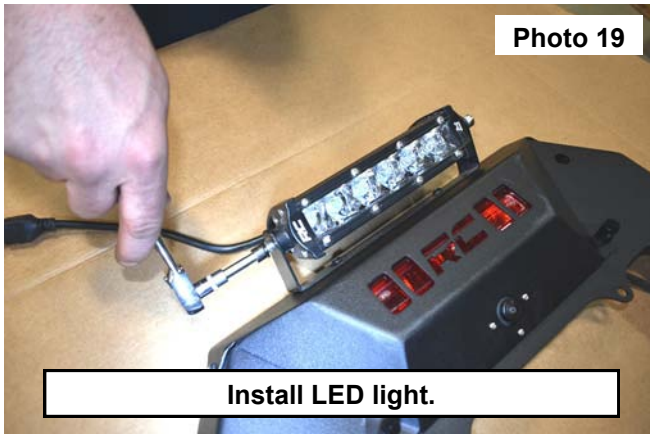

19. Reconnect the camera, 3rd brake light, if installed a 6-8" light wiring harness. **See Photo 21.**
20. Install the spare tire delete on to the rear door of the jeep, making sure the 3rd brake light, camera light and the LED light wires are not pinched and in the recessed notches on the edges of the spare tire delete. **See Photo 22.**

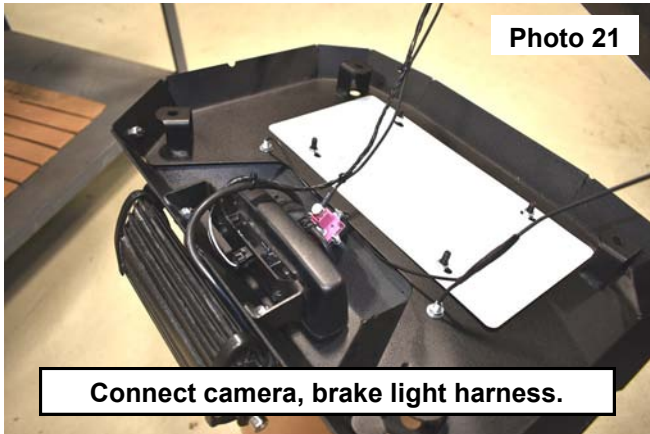

21. Secure the spare tire delete to the rear door using (4) 8MM-1.25x30MM bolts, tighten using a 5MM Allen wrench. **See Photo 23.**
22. Remove the 2 spare tire bump stops on the tale gate, Insert the 1/2 inch round plug in the 4 holes in the spare tire delete and the 2 in the bump stop holes on the rear door. **See Photo 24.**

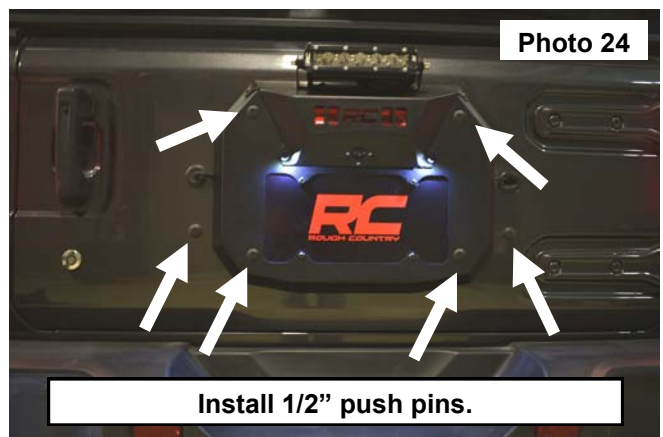



23. Wiring the tag light to the parking light wires.
24. Remove the gromet from the right side of the tailgate, cut a small hole through the plug just big enough to insert the wire. **See Photo 25.** This will be re installed in a later step.
25. Remove the inner trim panel from the tailgate, use care to remove the clips, these will be reused. **See Photo 26.**

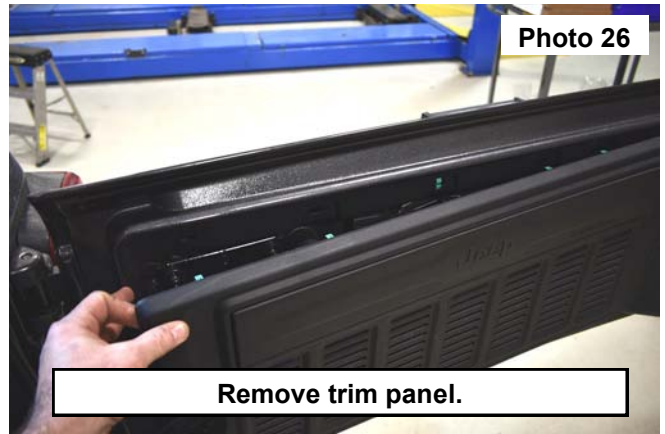

26. In the top right rear corner, remove the cover to access the tail light bolt, use a 10mm socket to remove. **See Photo 27.**
27. Remove tail light by pulling straight out. **See Photo 28.**

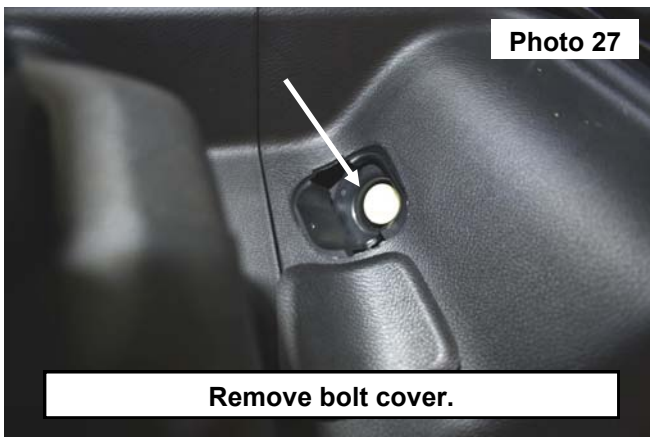

28. **Note the top/clip side of the plug.** Pull the red tab back to unlock then unplug the light wiring harness from the tail light. **See Photo 29.**
29. Jeeps equipped with the rear speaker will need to remove the 3 bolts in the storage hook strip from the floor, use a T40 torx to remove. **See Photo 30.** Set aside and retain hardware for reuse.

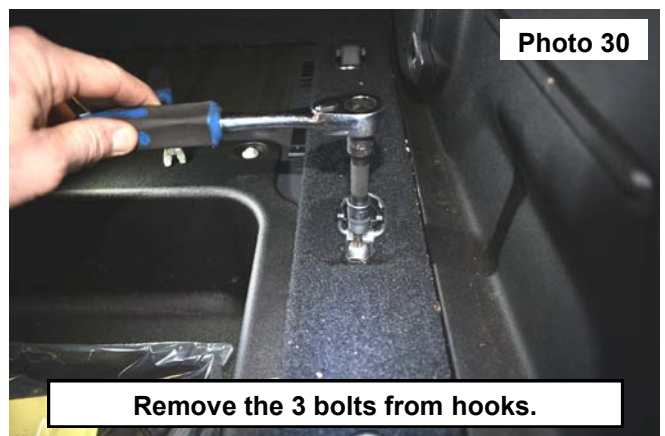

30. Pull the speaker trim panel back to make access for the wiring. **See Photo 31.**
31. Remove the tape from the ends of the fabric wire covering on each end, pull the wire through the tale gate and push the gromet in the tale gate that was removed in **photo 25.**
32. Insert the license plate light wire through the fabric covering and re tape the ends using electrical tape. **See Photo 32.**

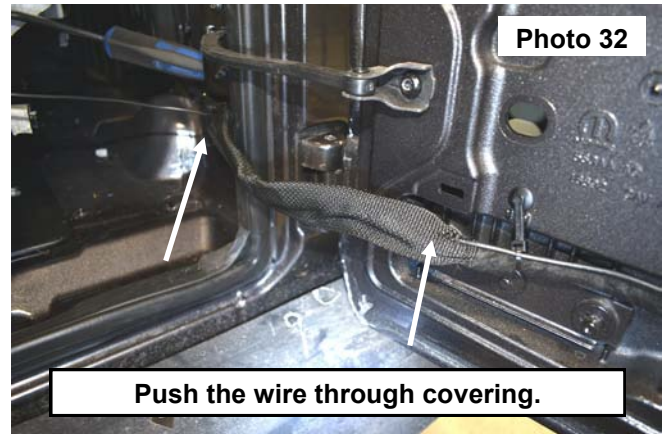
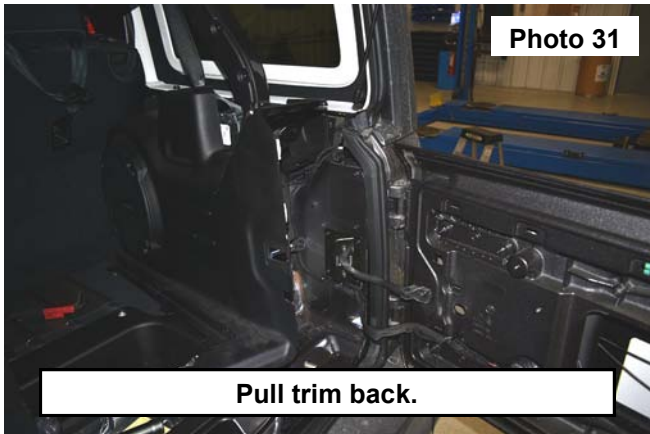

33. Insert the light wire into the rubber gromet in the upper right rear corner. **See Photo 33.**
34. **Note the top/clip side of the plug.** Make connections to the 4th and the 6th wire from the left, connect the red wire to the 4th wire, connect the black wire to the 6th wire. **See Photo 34.**

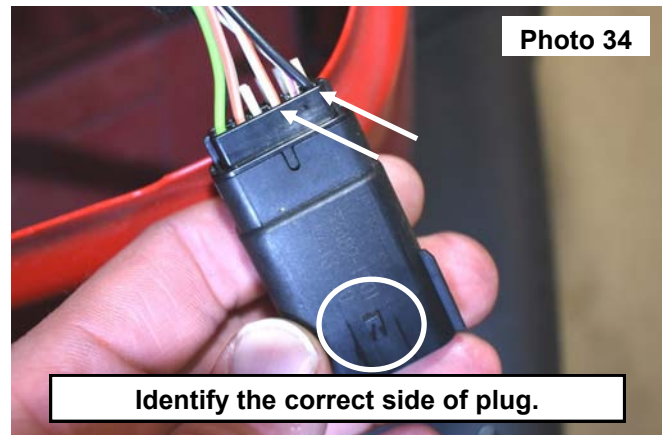
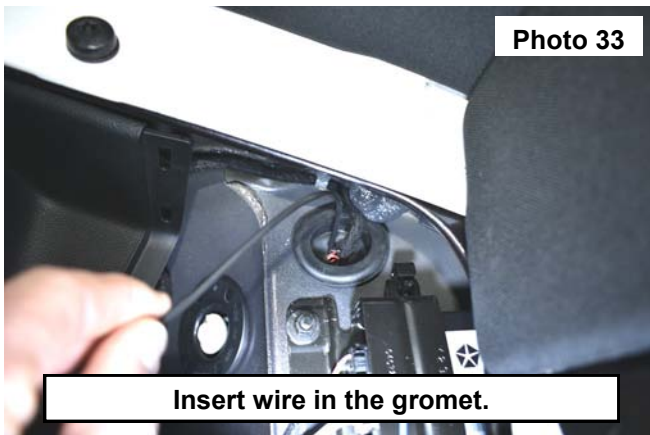

35. Secure the wires onto the tail light wiring harness, plug the stock tail light harness back into the tail light ,install the tail light, tighten the stock hardware using a 10mm socket . **See Photo 35.** Do not over tighten.
36. Secure the wires on the inside leading through the fabric wire covering, clip the speaker trim panel back together.
37. Re install the storage hook strip, use a T40 torx to tighten. **See Photo 36.**
38. Re install the trim panel on the tale gate, use care installing with the factory clips.





By purchasing any item sold by Rough Country, LLC, the buyer expressly warrants that he/she is in compliance with all applicable , State, and Local laws and regulations regarding the purchase, ownership, and use of the item. It shall be the buyers responsibility to comply with all Federal, State and Local laws governing the sales of any items listed, illustrated or sold. The buyer expressly agrees to indemnify and hold harmless Rough Country, LLC for all claims resulting directly or indirectly from the purchase, ownership, or use of the items.

