

FORD 2015-19 F-150 Cat Back Performance Exhaust System

Fits 2.7L, 3.5L and 5.0L Engine / Does NOT fit Standard Cab 6.5' Bed

Congratulations on your purchase of a Rough Country Performance Exhaust system.

Please read instructions before beginning installation. Check the kit hardware against the kit contents shown below. Be sure you have all needed parts and understand their location on the vehicle.

If question exist, please call us @1-800-222-7023. We will be happy to answer any questions concerning this product.

Check all fasteners for proper torque. Check to ensure for adequate clearance between all components.

Periodically check all hardware for tightness.

Allow adequate time for the exhaust to cool before disassembly.

NOTICE: Please see info below for various wheelbase options.

141" WB Regular Cab - 8' Bed. Trim 4" off of the inlet tube "A" then install. *Do not use tube "C".*

145" WB Super Crew - 5.5' Bed. Install inlet tube "A". *Do not use tube "C".*

145" WB Super Cab 6.5' Bed. Install inlet tube "A". *Do not use tube "C".*

157" WB Super Crew 6.5' Bed. Install tube "A". Trim 6" off of the extension tube "C" then install.

163" WB Super Cab 8' Bed. Install inlet tube "A" and the "C" extension tube with no trimming.

KIT CONTENTS:

Exhaust Clamps x6
Inlet Tube x1 (A)
Exhaust Frame Mount x1 (B)
Mid Tube x1 (C)
Muffler x1 (D)
Right Side Exit Tube x1 (E)
Left Side Exit Tube x1 (F)
Left Side Down Tube x1 (G)
Exhaust Bracket x1 (H)
Poly Exhaust Hanger x1 (I)
80 Deg. Exit Tubes x2 (J)
RC Exhaust Tips x2 (K)
Rear Exit Tube x2 (L)

TOOLS NEEDED:

5mm Allen
10mm Socket
13mm Socket
16mm Socket
9/16 Wrench and Socket

HARDWARE INCLUDED:

3/8-16 x 2 Hex Head Bolt x2
3/8-16 x 3.5 Hex Head Bolt x1
3/8 Flat Washers x2
3/8-16 Hex Nut x1
7/16" Hanger Keeper x2
1/2" Hanger Keeper x5
3" Band Clamp x2
2 1/2 Band Clamp x5
2 1/2" Band Clamp Hanger x1
2 x 2 Square Plate x 2

Torque Specs:

Size	Grade 5	Grade 8	Size	Class 8.8	Class 10.9
5/16"	15 ft/lbs.	20ft/lbs.	6MM	5ft/lbs.	9ft/lbs.
3/8"	30 ft/lbs.	35ft/lbs.	8MM	18ft/lbs.	23ft/lbs.
7/16"	45 ft/lbs.	60ft/lbs.	10MM	32ft/lbs.	45ft/lbs.
1/2"	65 ft/lbs.	90ft/lbs.	12MM	55ft/lbs.	75ft/lbs.
9/16"	95 ft/lbs.	130ft/lbs.	14MM	85ft/lbs.	120ft/lbs.
5/8"	135ft/lbs.	175ft/lbs.	16MM	130ft/lbs.	165ft/lbs.
3/4"	185ft/lbs.	280ft/lbs.	18MM	170ft/lbs.	240ft/lbs.



INSTALLATION INSTRUCTONS

1. After stock exhaust has adequately cooled, loosen the front 2 bolts in the exhaust flange using a 13mm socket. **See Photo 1.**
2. Loosen the inlet clamp using a 13mm socket. **See Photo 2.**

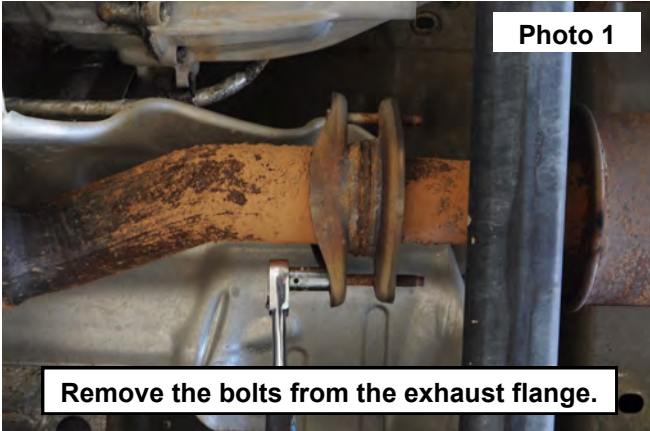

3. Remove the 2 bolts in the exhaust frame mount using a 10mm socket. Retain hardware for reuse. **See Photo 3.**
4. Remove the exhaust hanger bolt from the rear of the muffler using a 13mm socket. Retain hardware for reuse. **See Photo 4.**

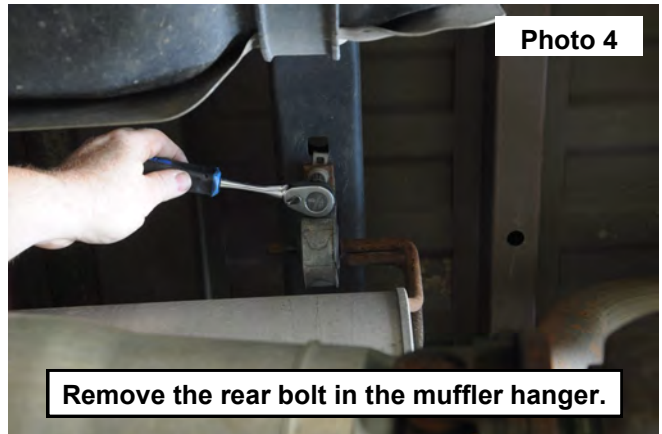
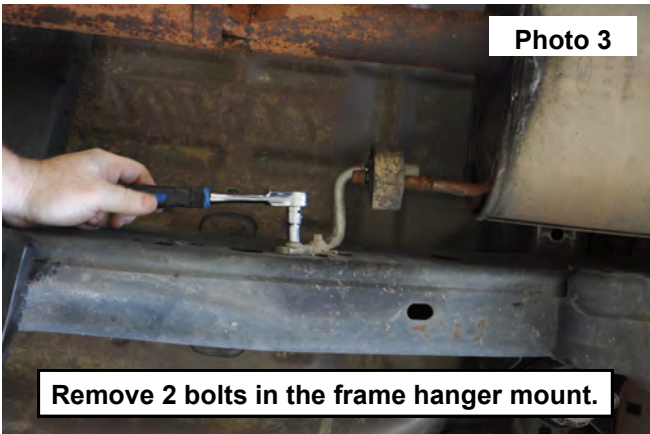

5. Remove the exhaust hanger in the rear of the vehicle and slide the muffler out of the mid tube, let the muffler and the back section of tube swing down and out over the rear end. **See Photos 5 and 6.**

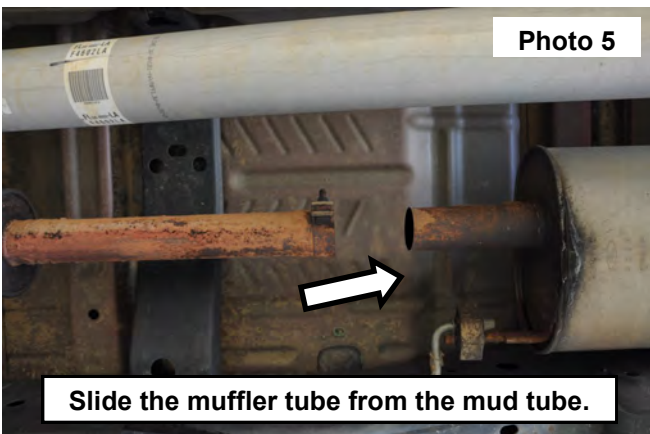

6. Remove the 2 bolts from the mid tubes flange that was previously loosened. Then remove the mid tube from the vehicle. **See Photo 7.**
7. Install the flange onto the inlet tube "A", secure using 1 of the supplied 3/8-16 x 2" hex head bolt (2) 3/8 flat washers and (1) 3/8-16 nylock nut. **See Photo 8.**

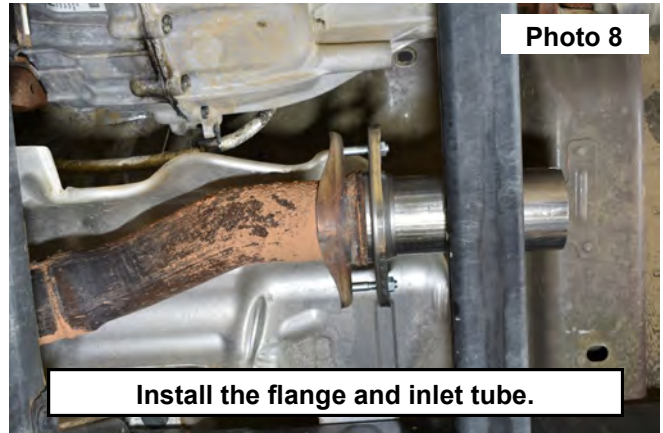
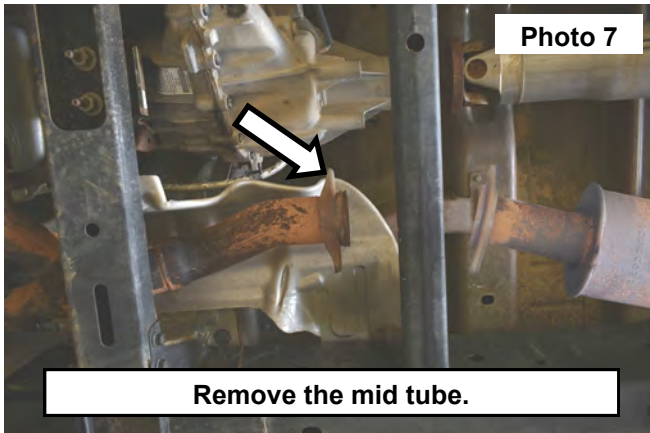

8. Install a clamp and the mid tube "C" onto the rear of the first exit tube "A". Snug clamp using 16mm socket. **See Photo 9.**
9. Remove the OE frame mount from the stock exhaust leaving the rubber hanger on the mount.
10. Install the frame mount using the stock hardware. Install the supplied clamp mount "B" onto the mid tube and into the rubber hanger mounted on the frame. Snug using a 16mm socket. **See Photo 10.**

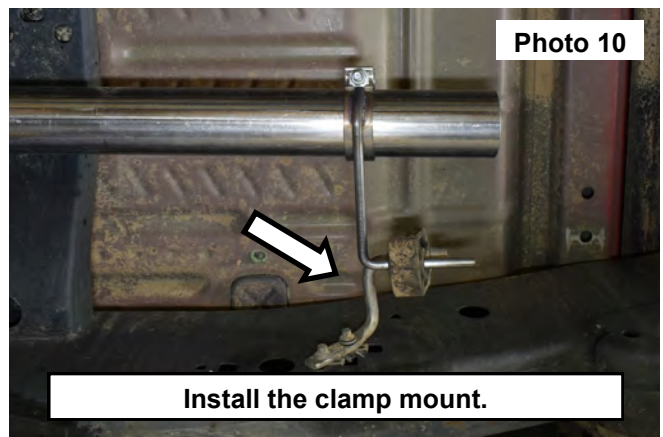
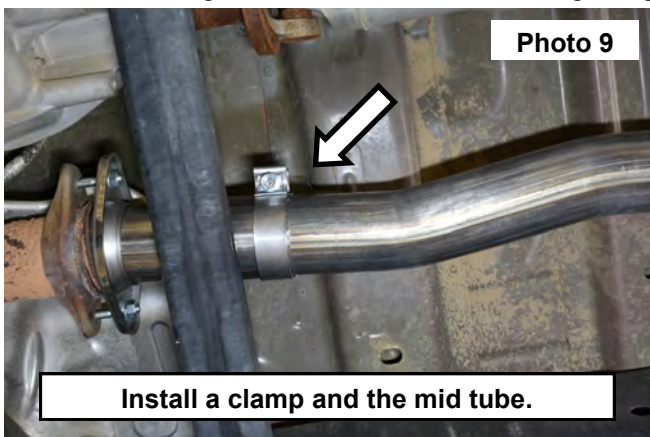

11. Install a clamp onto the muffler inlet flange, then install the muffler "D" onto the mid tube. Snug the clamp using a 16mm socket. **See Photo 11.**
12. Install the retained muffler hanger and hardware. Location at the top of photo 12.
13. Install clamps onto the exit flange of the muffler. Then install the left side exit tube "E" into the muffler and the OE hanger. Snug the clamp using a 16mm socket. **See Photo 12.**

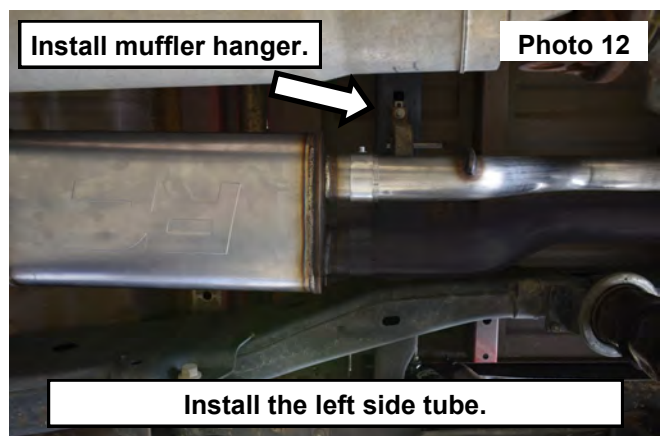
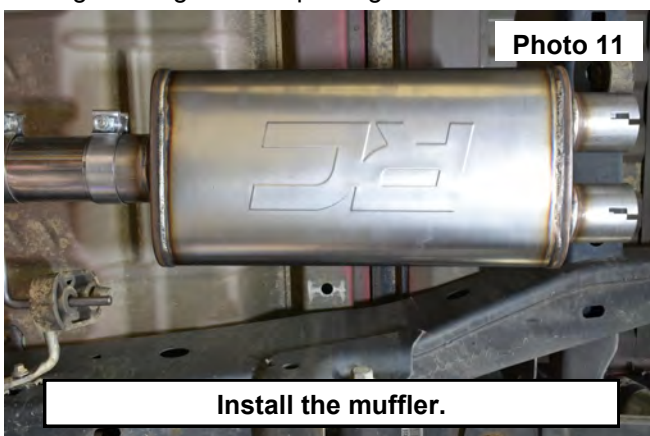

14. Install a clamp and the left side rear down tube into the installed rubber hanger then into the exit tube. Snug the clamp using a 16mm socket. **See Photo 13.**
15. Install the frame exhaust hanger mount "H" using the supplied 3/8-16 x 3.5" hex head bolt, (2) 3/8 flat washers and (1) 3/8-16 nylock nut. Tighten using a 9/16 wrench and socket. Then install the rubber hanger "I" onto the frame mount. **See Photo 14.**

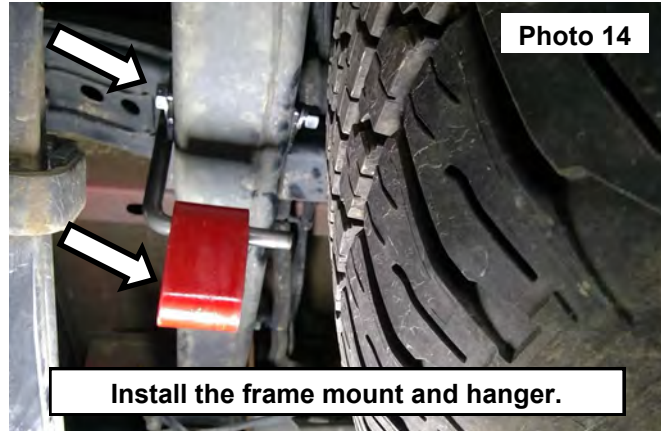
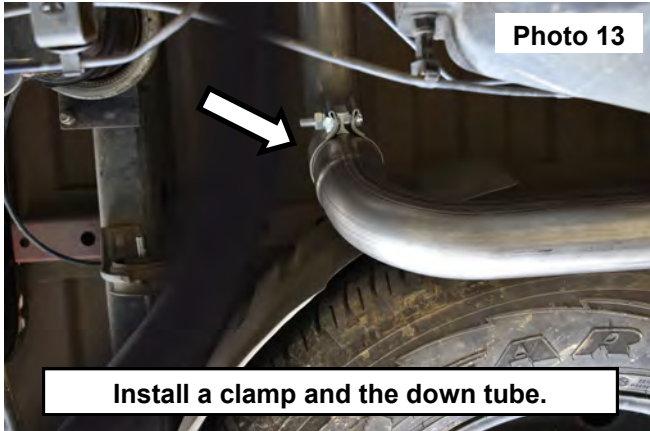

16. Install the right side exit tube "F" into the OE frame mount then into the exit flange on the muffler. Snug the clamp using a 16mm socket. **See Photo 15.**
17. If rear exit is desired, install a clamp then the 80 deg. exit tubes "J" on each side of the vehicle. Snug the clamp using a 16mm socket so the tube can still be adjusted. **See Photo 16.** If rear exit is desired, install the supplied extensions "L" and install clamps.

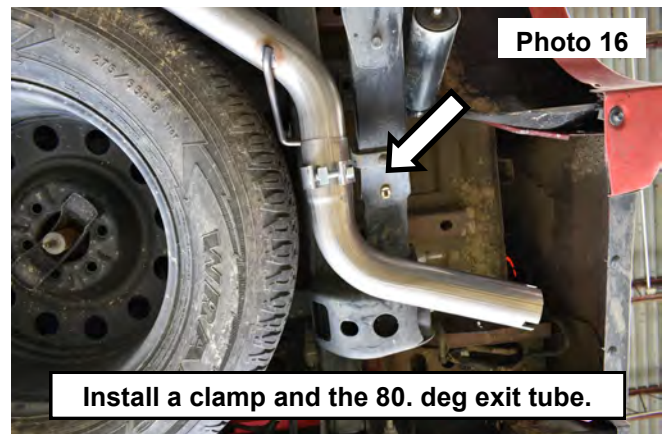
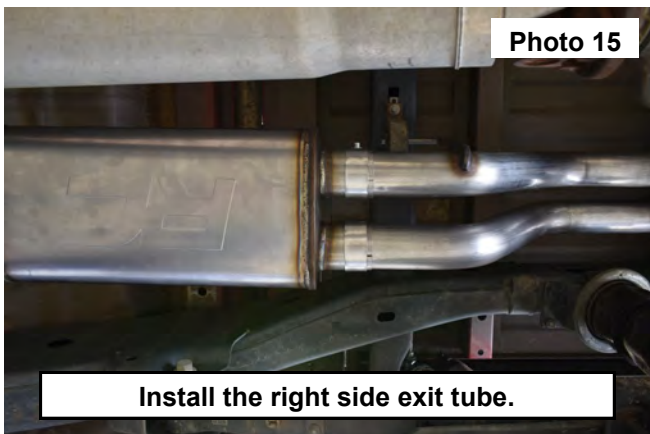

18. Install the right and left side exhaust tips "K" (Side exit shown) by adjusting the 80 deg pipe leaving the tip 1 - 2" away from the edge of the bottom of the bed, Leave the tip enough area not to contact the bed when the vehicle is in motion. **See Photo 17.**
19. Tighten the exhaust tips using a 5mm Allen and a 10mm socket.
20. Install the supplied retainer clips onto the tube hangers installed through the rubber exhaust hangers. **See Photo 18.**

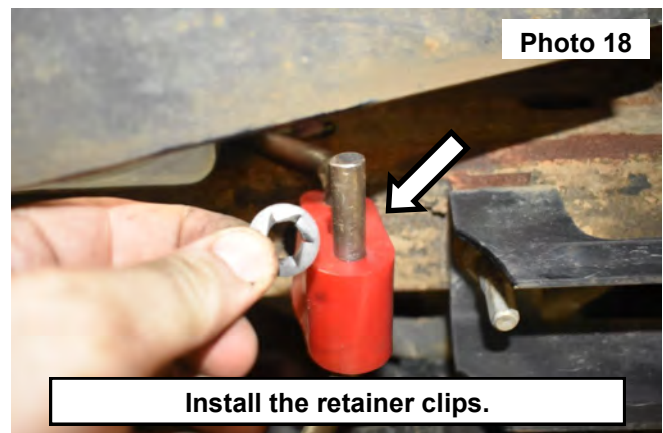

21. Adjust exhaust tubes and tighten all of the installed clamps throughout the exhaust system using a 16mm socket.
22. Periodically check all hardware for tightness.



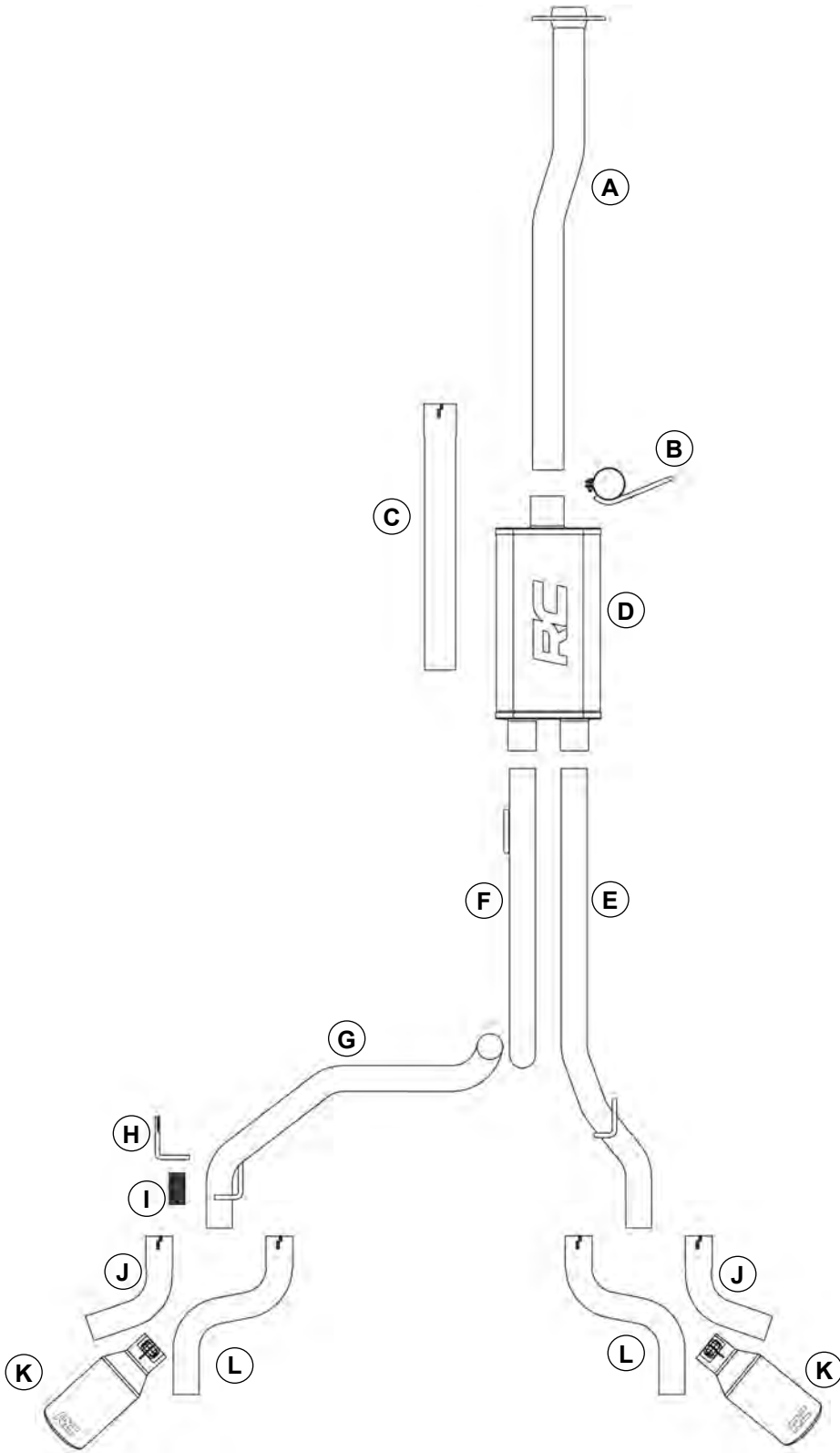

By purchasing any item sold by Rough Country, LLC, the buyer expressly warrants that he/she is in compliance with all applicable, State, and Local laws and regulations regarding the purchase, ownership, and use of the item. It shall be the buyers responsibility to comply with all Federal, State and Local laws governing the sales of any items listed, illustrated or sold. The buyer expressly agrees to indemnify and hold harmless Rough Country, LLC for all claims resulting directly or indirectly from the purchase, ownership, or use of the items.

