

ROUGH COUNTRY

SUSPENSION SYSTEMS®



1272BAG8

99-06 CHEVY/GM 1500 4 & 6"NTD DROP LIFT KIT

Thank you for choosing Rough Country for all of your suspension needs.

Rough Country recommends a certified technician installs this system. In addition to these instructions, professional knowledge of disassemble/reassembly procedures as well as post installation checks must be known. Attempts to install this system without this knowledge and expertise may jeopardize the integrity and/or operating safety of the vehicle.

Please read all the instructions before beginning the installation. Check the kit hardware against the Kit Contents list on next page. Be sure you have all the needed parts and understand where they go. Also please review the tools needed list to be certain that you have the tools necessary to complete the installation.

PRODUCT USE INFORMATION

▲ WARNING As a general rule, the taller a vehicle is the easier it will roll. We strongly recommend, because of roll-over possibility, that seat belts and shoulder harnesses should be worn at all times. Avoid situations where a side roll-over may occur. Braking performance and capabilities are decreased when significantly larger/heavier tires and wheels are used. Take this into consideration while driving. Also, speedometer recalibration is necessary when larger tires are installed.

Do not add, alter, or fabricate any factory or after-market parts which increase vehicle height over the intended height of the Rough Country product purchased. Mixing component brands, lifts, with this suspension lift voids all warranties. Rough Country makes no claims regarding lifting devices and excludes any and all implied claims. We will not be responsible for any product that is altered.

▲ NOTICE Due to differences in manufacturing, dimension and inflated measurements, tire and wheel combinations should be test fit prior to installation. For the **4"** application we recommend a wheel not to exceed 9" in width with 4.5 " of backspacing.. Additionally a quality tire of radial design is recommended, not exceeding 33" tall and 12.5" wide. For the **6"** application we recommend a wheel not to exceed 9" in width with 4.5 " of backspacing.. Additionally a quality tire of radial design is recommended, not exceeding 35" tall and 12.5" wide. Please note that use of a 35" x 12.5" tire may require modification to the front valance. If this vehicle was equipped from the factory with 17" wheels and if purchasing new wheels, the wheel size must not be below 17" but can be larger than 17" due to the vehicle being equipped with larger calipers /rotor.

▲ NOTICE NOTICE TO DEALER AND VEHICLE OWNER

Any vehicle equipped with any Rough country product must have the "Warning to Driver" decal installed on the sun visor or dash. The decal is to act as a constant reminder for whoever is operating the vehicle of its unique handling characteristics. **INSTALLING DEALER**—It is your responsibility to install the warning decal and to forward these installation instructions on too the vehicle owner for review and to be kept in the vehicle for its service life.

▲ NOTICE Note to installer : Before installation begins we recommend that a test drive be performed. While driving check for uncommon sounds and/or vibrations . What you feel and hear during the test drive will only magnify once lift kit is installed. Advise you to discuss possible issues identified from drive with customer before proceeding to install this kit.

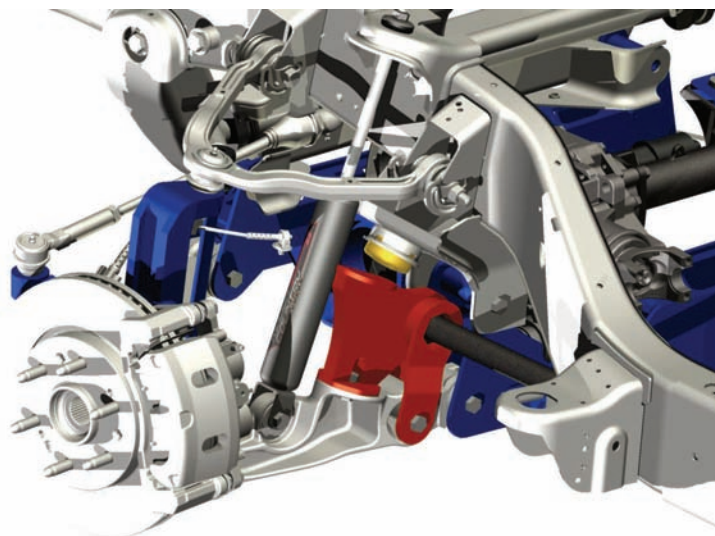

KIT CONTENTS



KIT CONTENTS ON NEXT PAGE

Kit Contents:**1272Box7**

Front Cross Member
Rear Cross Member

1272Box6

Front Skid Plate
NTD Brackets
Dr Diff Bracket
Pass Diff Bracket
Front Sway Bar Links (2)
Front Sway Bar Link Brackets (4)
CV Axle Spacers (2)
LinkBag1- Sway Bar Link Hardware
1272Bag7- Diff, Skid, NTD Hardware
1272Bag8-Instructions
1272Bag9-Cross Member Hardware

1272Box5-6" kit OR 1258Box6- 4" kit

Front Shock Part #658734 (2)
Rr Shock Part # 658727 (2)
Shock Hardware Bag (1)
Lift Blocks (2)
9/16" X 2 1/2" X 13 1/2" U-bolts (4) 6" Kit
OR
9/16" x 2 1/2" x 12 1/2" U-bolts (4) 4" Kit
U-Bolt Kit Bag (1)

1285

Driver Side Knuckle
Pass Side Knuckle

Fastener Breakdown:**1272Bag9-**

For Front Cross Member
5/8" x 4 1/2" Bolt (2)
5/8" Washer (4)
5/8" Nut (2)
For Rear Cross Member
5/8" x 5 1/2" Bolt (2)
5/8" Washer (4)
5/8" Nut (2)

1272Bag3-

For Axle CV Spacers
10mm x 65mm Allen Bolt (12)

1272Bag 7-

For Pass Side Dif Drop Brkt.
1/2" x 1 1/2" Bolt (2)
1/2" Washer (4)
1/2" Nut (2)
For Driver Side Dif Drop Brkt.
Poly Bushings (2)
2.41" x 9/16"ID Sleeve (1)

For Skid Plate

3/8" x 1" Self Taping Bolt (2)
9/16" x 4 1/2" bolt (1)
9/16" Washer (2)
9/16" Nut (1)
3/8" x 1" Bolts (2)
3/8" Nylock Nuts (2)
3/8" Flat Washers

1272Bag7- Cont'd**For Non-Torsion Bar Bracket**

1/2" x 1 3/4" Bolt (2)
1/2" Washer (2)
1/2" Nut (2)
Sleeve (2)
3/4" X 5.5" Bolt (2)
3/4" Nylock Nut (2)
3/4" Washer (4)

283N2BAG2-**For Front Shocks:**

2- Male Stem Bushings
2- Female Stem Bushings
4- 3/8 Cup Washers
2- 3/8 Nuts

9/16BAG-**For Rear U-Bolts**

9/16" Washer (8)
9/16" Nut (8)

1263BAG2-**For Blocks**

4-7/16" x 3 1/8" x 3 1/4" Ubolts
8-7/16" Flat Washers
8-7/16" Nylock Nuts

TOOLS NEEDED:**Floor Jack****Jack Stands**

10mm socket /wrench
11mm socket /wrench
13mm Deep Socket
13mm wrench
15mm socket / wrench
17mm socket / wrench
18mm socket /wrench
19mm socket /wrench
21mm socket /wrench
24mm socket /wrench
35mm socket

9/16 socket /wrench
7/8" deep well socket
Torsion bar Tool
Drill
17/32 Drill Bit
Loc-Tite
Reciprocating Saw

Size	Grade 5	Grade 8
5/16"	15 ft/lbs	20 ft/lbs
3/8"	30 ft/lbs	35 ft/lbs
7/16"	45 ft/lbs	60 ft/lbs
1/2"	65 ft/lbs	90 ft/lbs
9/16"	95 ft/lbs	130 ft/lbs
5/8"	135 ft/lbs	175 ft/lbs
3/4"	185 ft/lbs	280 ft/lbs

TORQUE SPECS:

	Class 8.8	Class 10.9
6MM	5 ft/lbs	9 ft/lbs
8MM	18ft/lbs	23 ft/lbs
10MM	32ft/lbs	45ft/lbs
12MM	55ft/lbs	75ft/lbs
14MM	85ft/lbs	120ft/lbs
16MM	130ft/lbs	165ft/lbs
18MM	170ft/lbs	240ft/lbs



FRONT INSTALLATION

1. Place the truck on a clean level surface and set the parking brake. Chock the rear wheels and using a floor jack raise the front of the truck and support the frame rails with approved jack stands. Never work under an unsupported vehicle. Using a 7/8" deep well socket remove the front wheels.
2. Locate the torsion bar adjuster bolt on the bottom of the rear cross member, measure the threads showing on the torsion bar adjuster bolt. Mark the position of the torsion bars on the control arm and torsion bar key. Mark both the drivers side and passenger side. **See Photo 1.**
3. Using a torsion bar tool, relieve the pressure from the torsion bar adjuster bolt and remove the bolt and threaded block. **See Photo 2.**

⚠WARNING Be extremely careful when loading and unloading the torsion bars; there is a tremendous amount of stored energy in the bars. Keep you hands and body clear of the adjuster arm assembly and the puller tool in case anything slips or breaks.

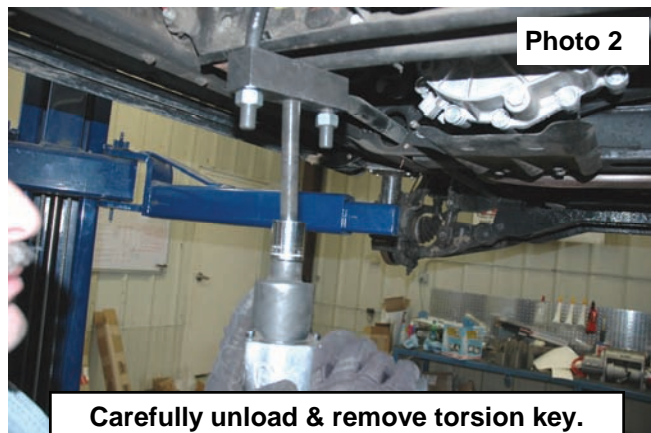
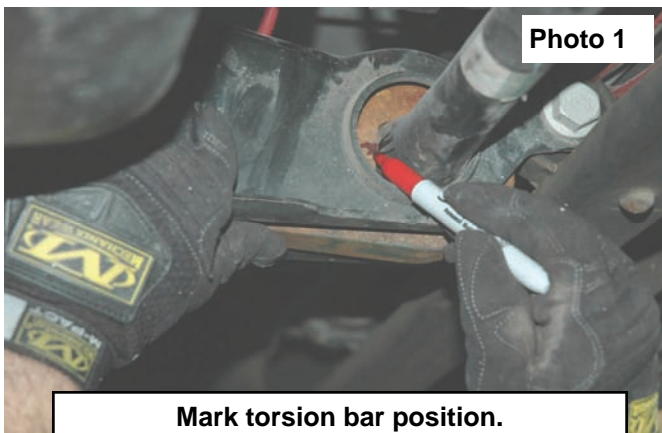

4. Using a 15 mm socket remove the factory lower skid plate. **See Photo 3.**
5. Starting on the drivers side use a 10mm socket to remove the brake line from the upper control arm and knuckle. Unplug the ABS wire from the frame rail. **See Photo 4.**

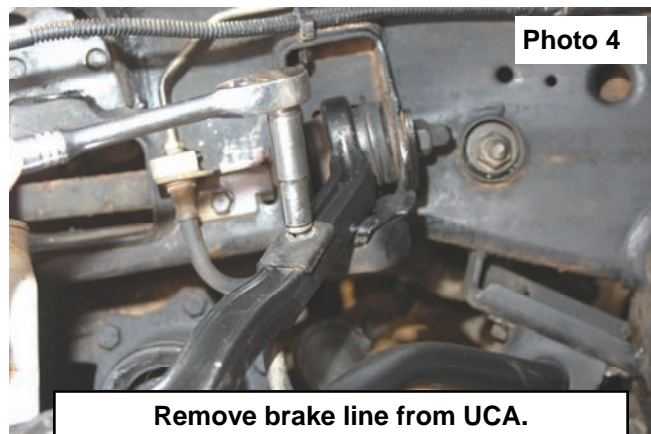

6. Using a 18mm socket unbolt the brake caliper and rotor. Secure the brake caliper out of harms way. **See Photo 5.**
7. Using a 35 mm socket remove the CV nut from the knuckle. **See Photo 6.** Remove the tie rod from the stock knuckle using a 18mm wrench. Strike the side of the knuckle where the tie rod mounts to dislodge the tapered tie rod end. Retain the stock hardware for reuse.

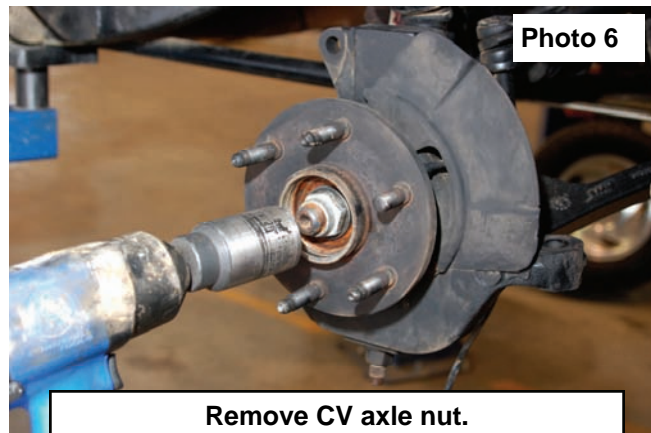
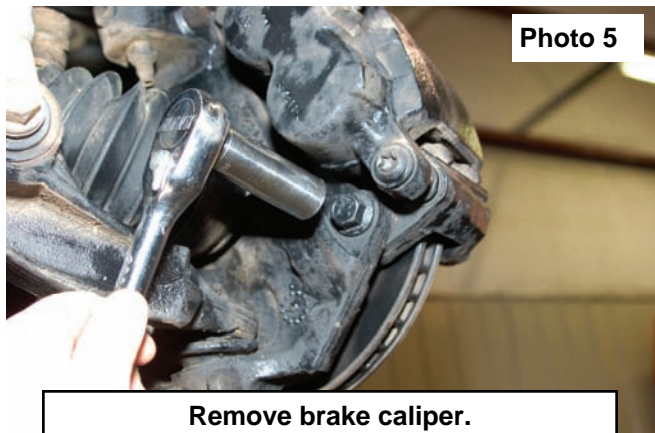

8. Using a 18mm wrench for the upper ball joint and a 24 mm deep well socket for the lower, remove the ball joint nuts. Using a hammer hit the knuckle as shown until the ball joint is free. **See Photo 7 & 8.** Remove the knuckle.

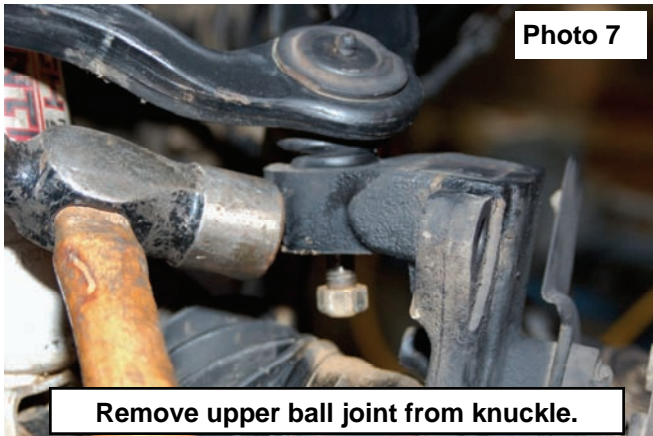

9. Remove the three factory bolts that hold the wheel bearing to the stock knuckle. Remove the wheel bearing and dust cover using a 15mm socket. Locate the new knuckles supplied with the kit and using Loc-Tite; install the bearing with the factory hardware on the new knuckle. Tighten to 133 ft.lbs. **See Photo 9.**
10. Using a 13mm deep well socket remove the sway bar link from the lower control arm and sway bar. **See Photo 10.**

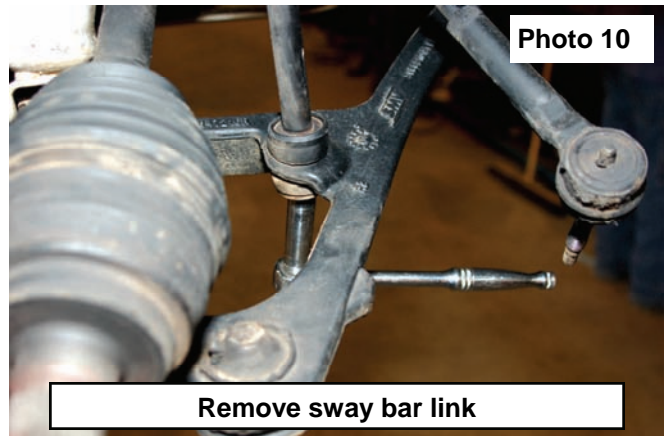
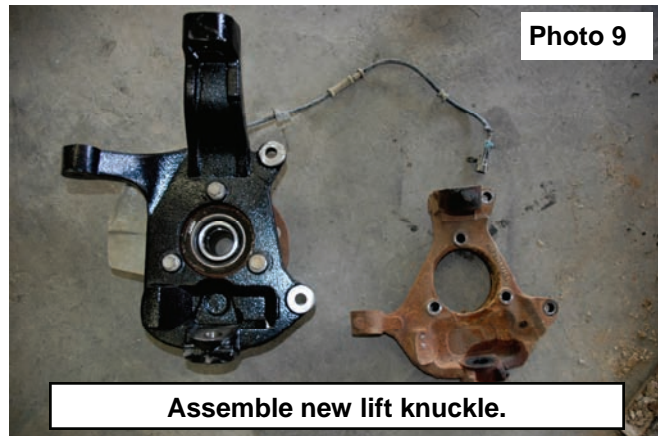

11. Using a 15 mm wrench remove the upper shock nut. Using a 21 mm socket and 21 mm wrench remove the lower shock bolt. Remove the shock. Retain the hardware for reuse.
12. Using a 15mm socket remove the 6 inner CV bolts. **See Photo 11.** Set CV half shaft aside for reuse.
13. Using a 18mm wrench and a 24 mm socket remove the lower control arm hardware and remove the lower control arm. Retain the hardware for reuse. Repeat steps 5 through 13 on passenger side.
14. Support the differential with a floor jack and remove the two nuts on the passenger side that secures the differential to the frame using a 21mm wrench. Remove the upper differential bolt that secures the driver side differential to the frame using a 21mm wrench.
15. Mark the front driveshaft and yoke for reference and remove the front driveshaft from the differential using a 11mm wrench. Secure driveshaft out of harms way. **See Photo 12.**

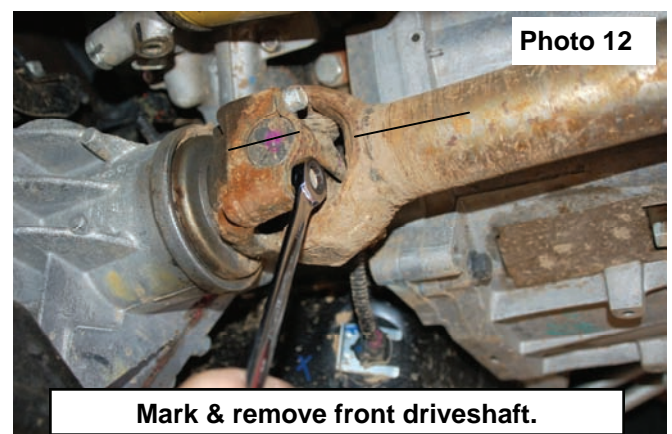
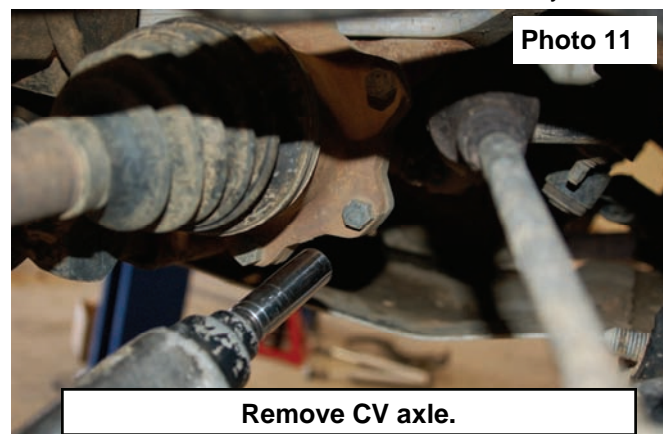

16. Remove the lower differential bolt on the drivers side using a 21mm wrench. Jack up the differential to allow for the trimming of the drivers side stock mount.
17. Cut the frame as shown in **Photo 13** with a reciprocating saw. After trimming, Remove the differential vent hose, differential plug and the plug clips from the axle. With assistance lower the differential down and remove from the vehicle.
18. Cut the differential as shown in **Photo 14** using a reciprocating saw. Take care not to damage the differential.

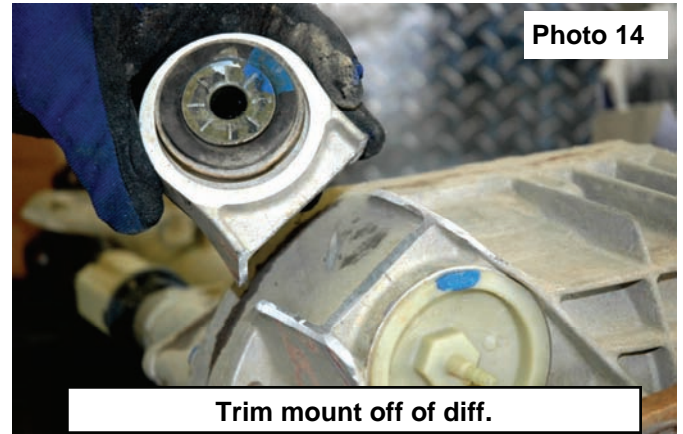
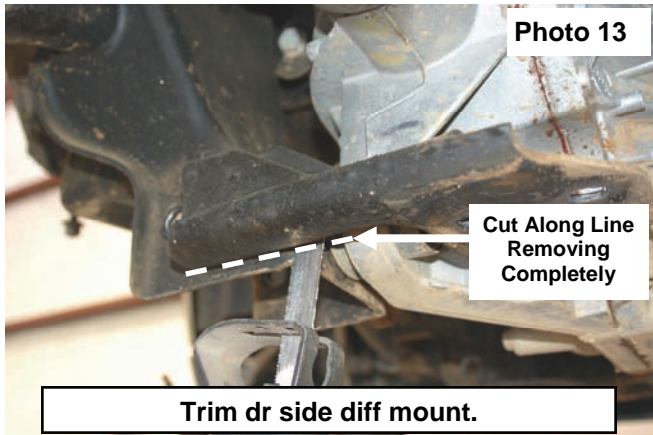

19. Locate the driver differential bracket and install the bushings /sleeve in the mount. Install on the differential as shown with factory hardware using a 15mm socket. Tighten to 35ft. Lbs. **See Photo 15.**
20. Install the supplied sleeve in the lower control as shown in **Photo 16** arm and install the Torsion bar bracket on the lower control arm. **Note: There is a driver and passenger side bracket.**

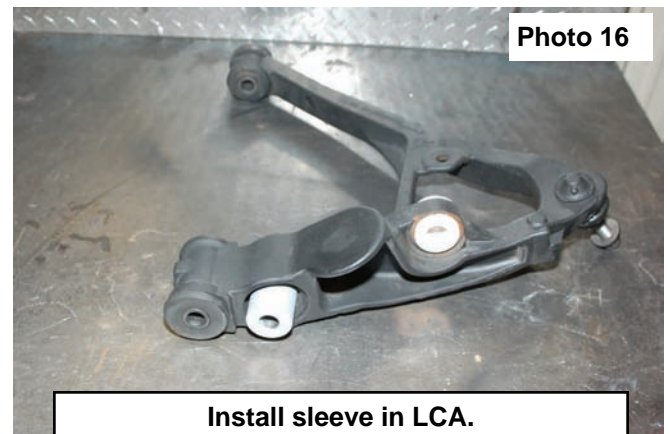
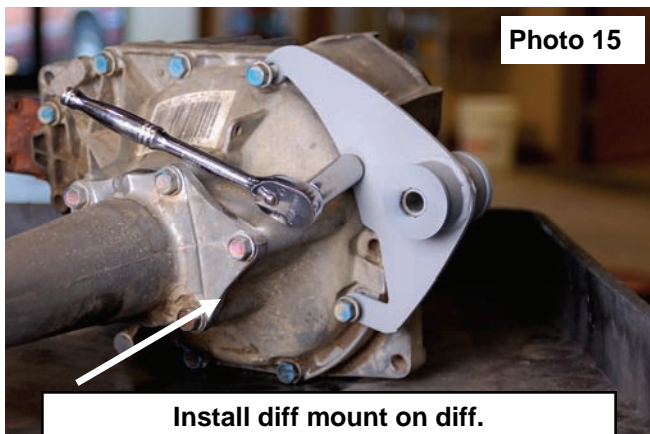

21. Using the bracket as a guide, mark the lower control arm and remove the Torsion Bar Bracket from the arm. **See Photo 17. Passenger Side arm shown. A template is included it is recommended to use the template to check that the hole is centered in the mount. Failure to confirm the proper location of the hole may lead to interference of the shock absorber by the bump-stop bracket.**
22. Drill the lower control arms using a 17/32" drill bit and reinstall the torsion bar bracket on the lower control arm and tighten the supplied 1/2" x 1 3/4" bolts, washers & nuts and 3/4" x 5.5" bolts, washers, & nuts from, 1272BAG7. **See Photo 18.**

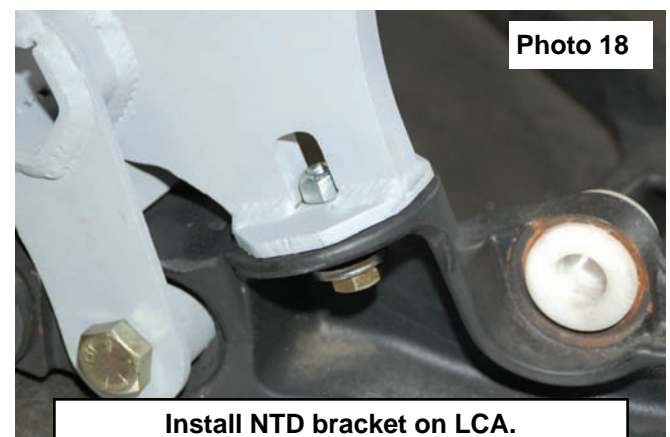
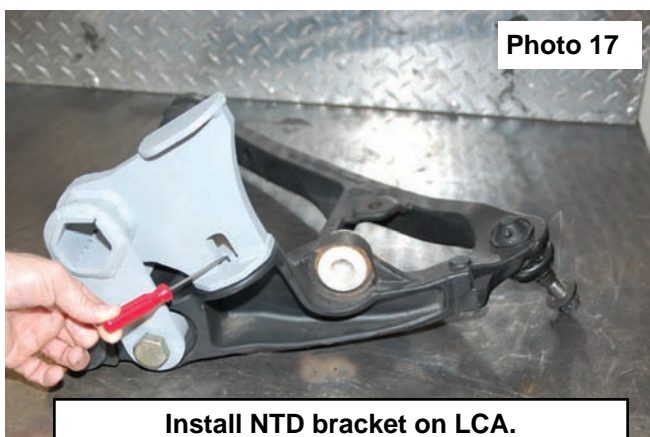

23. Install the rear cross-member as shown in **Photo 19** with supplied 5/8" X 5 1/2" bolts, washers and nuts from 1272Bag9. Install the bolts from the front to the back. Do not tighten at this time. If the optional kicker braces were purchased with this kit, install the mounting brackets on the rear cross member using the instructions included with that kit.
24. Install the passenger side differential bracket as shown, using factory hardware, in **Photo 20** (tall end of taper positioned towards front of vehicle) with the factory hardware using a 21mm wrench. Do not tighten at this time.

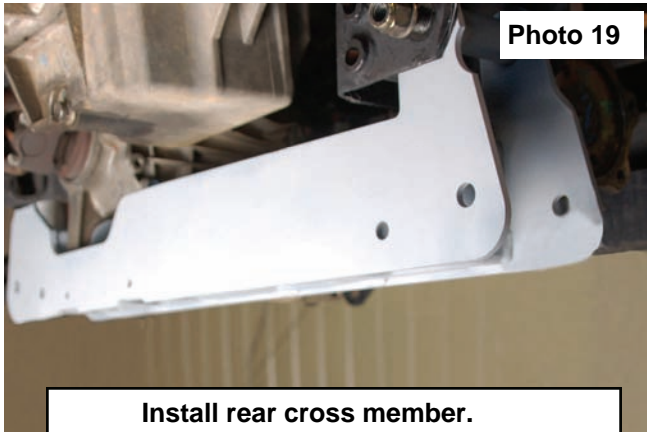

25. NOTE: It will be necessary to trim the cooling fins on the side of the differential to allow for clearance on the frame. Trial fit the differential in the lower mount and trim the cooling fins as needed using a hand grinder. **See Photo 21.** With assistance raise the differential into place and install the rear mount of the differential into the new cross-member mount with the stock hardware. **See Photo 22.** Do not tighten at this time.

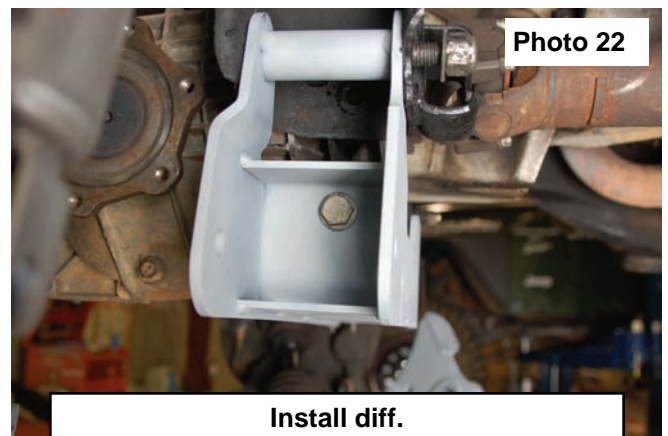
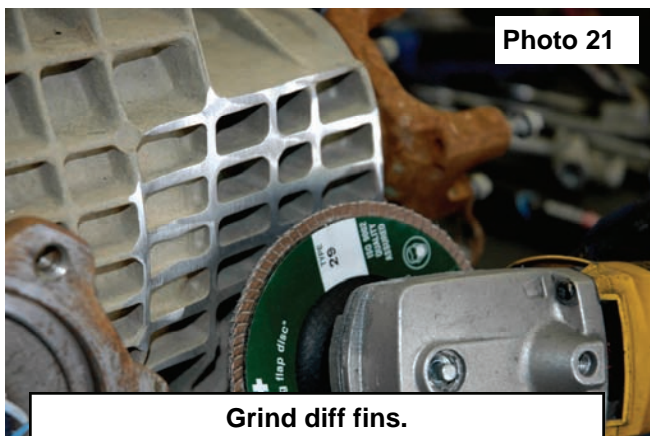

26. Reinstall the passenger side of the differential into the new mounts with the supplied 1/2" x 1 1/2" bolts, washers & nuts from 1272Bag7. Do not tighten at this time. Reinstall the driveshaft using marking made as a reference and secure using factory hardware and tighten using a 11mm wrench. Tighten to 19 ft. lbs.
27. Install the differential brace onto the front cross member using the supplied 1/2" x 1.5" bolts, washers and nylock nuts from 1272Bag7. Tighten using 3/4" wrenches. **See Photo 23.**
28. Install the front cross-member as shown in **Photo 24** with the supplied 5/8" x 4 1/2" bolts, washers and nuts from 1272Bag9. Do not tighten at this time.

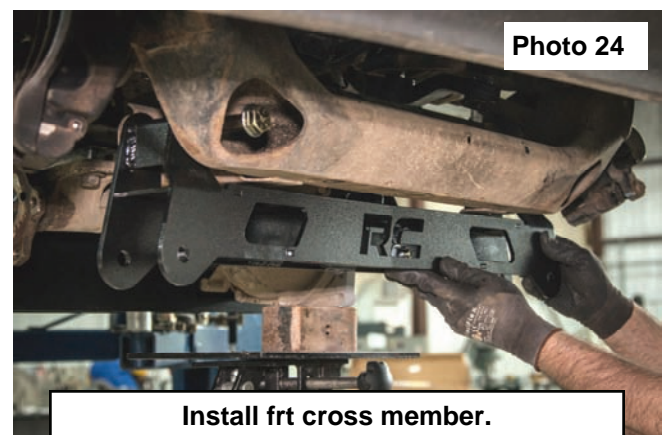
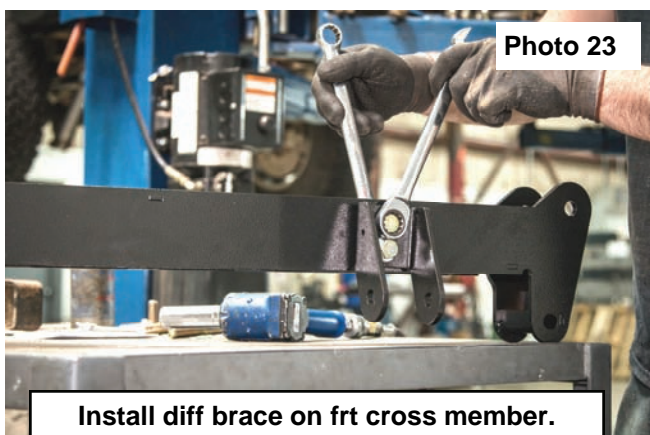

29. Install the differential bracket in the mounting tab on the back side of the front cross member using the supplied 1/2" x 4 1/2" bolt, washers and nut from 1272Bag7. Install the skid plate by lining up the holes in the cross-members and installing the supplied 3/8" self tapping bolts in the rear and the 3/8" x 1" bolts, nuts, and washers(1272Bag7) in the front, tighten using a 9/16" socket and wrench. **See Photo 25 & 26.** Pull the differential vent hose that was previously disconnected down to install in the stock location and reinstall differential plug and wiring clips to the differential.

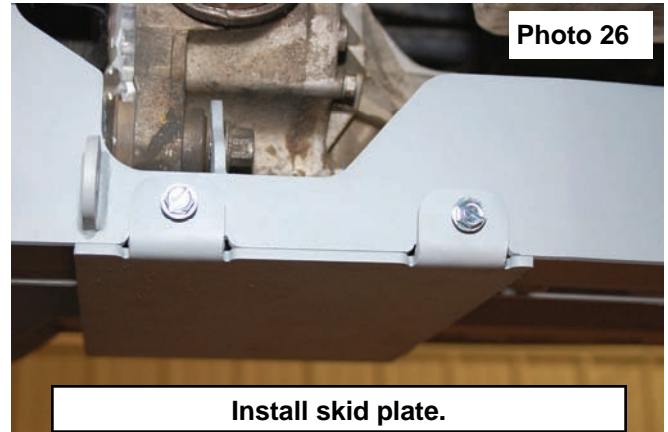
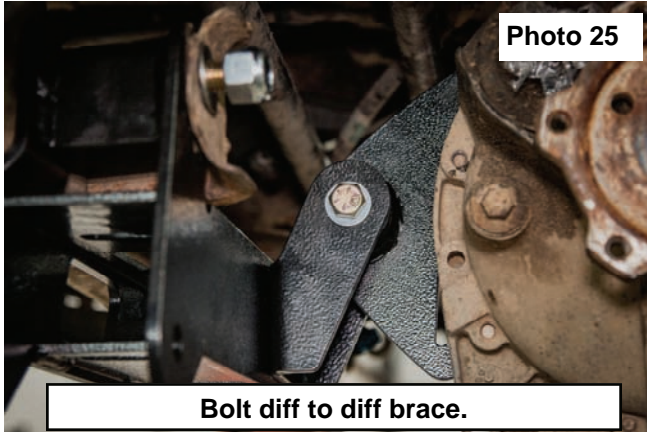

30. Install the lower control arms with the torsion bar drop brackets in the new drop brackets with the factory hardware (bolts install front to rear). **See Photo 27.** Do not tighten control arm hardware at this time.
31. Push the lower control arm up to check for any clearance issues. If needed cut the factory cross member. Cross member has been trimmed in **Photo 28.**

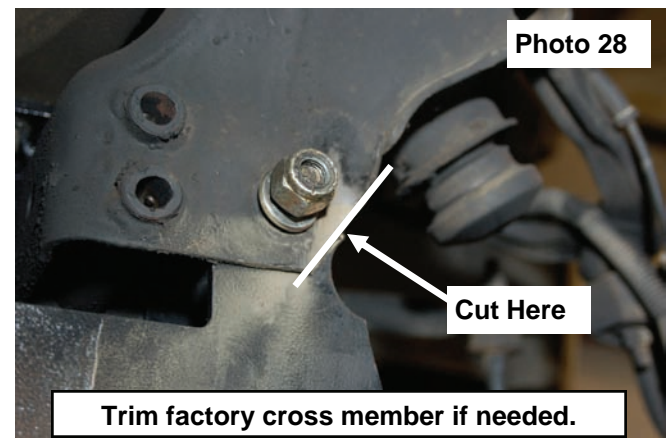
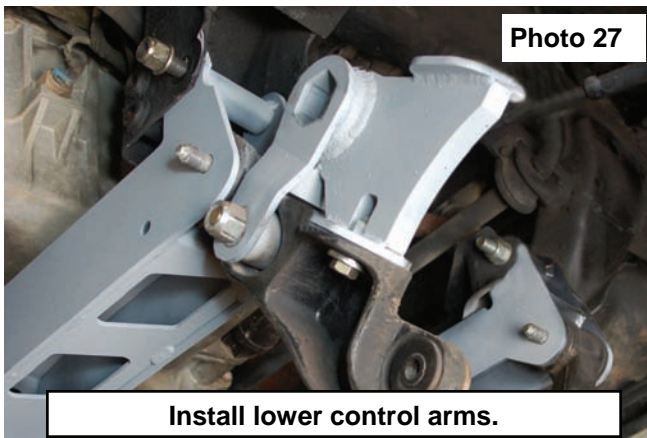

32. Tighten cross-member and differential drop bracket hardware at this time. Tighten 5/8" cross member hardware to 154 ft. lbs., 9/16" differential hardware to 114 ft. lbs., factory hardware on passenger differential bracket to 75ft.-lbs.
33. Install the new knuckles with the stock ball joint hardware and tighten using a 18mm & 24mm wrench.
34. Install the brake caliper with factory hardware. Using a 10mm wrench install the brake line on the knuckle. **See Photo 29.** Tighten upper ball joint to 37 ft. lbs and lower to 94 ft. lbs. and tighten brake hardware. Reconnect the ABS wire. If more slack is needed the line can be sprayed with 10-40 and the mounts slid down.
35. Install the stock shafts in the knuckle with factory hardware and using a 35mm socket. Locate the supplied CV spacers and place the spacer in between the differential and the shaft as shown in **Photo 30.** Using Loc-Tite, secure with the supplied 10mm x 65mm Socket head cap bolts (1272BAG3) with 8mm allen wrench. Torque hardware to 58 ft.-lbs.

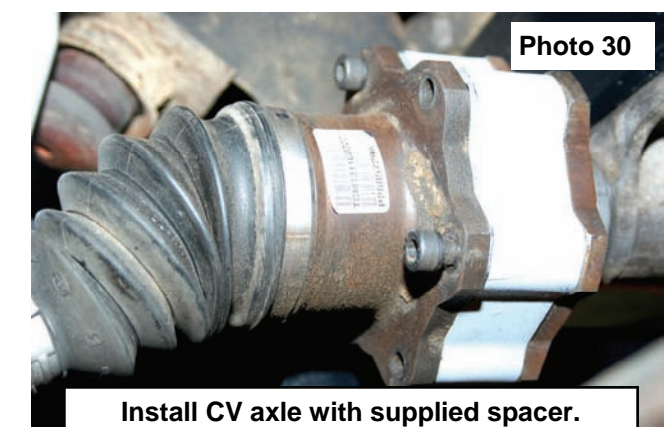
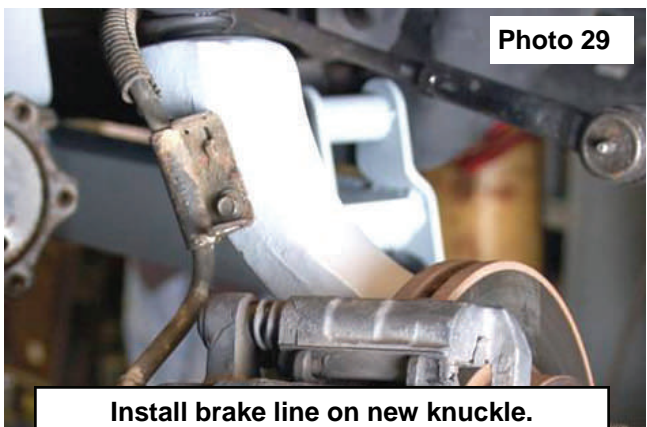

36. Install the tie rod end in the knuckle with the stock hardware and using a 19mm wrench. Tighten to 50 ft.-lbs.
37. Install the supplied sway bar link bracket as shown in **Photo 31** on the lower control arm using the supplied 12mm x 35mm bolt and flange lock nut from LinkBag1. Tighten using a 18mm & 19mm wrench.
38. Install the upper sway bar link bracket as shown on the sway bar with the supplied 12mm x 35mm Bolt and flange lock nut from LinkBag1. **See Photo 32.**



Install sway bar bracket on LCA.



Install sway bar bracket on sway bar.

39. Install the sway bar link in the upper bracket with the supplied 12mm x 65mm bolt and flange lock nut from LinkBag1. **See Photo 33.** Tighten using a 18mm & 19mm wrench.
40. Install the sway bar link in the lower bracket and secure with the supplied 12mm x 65mm Bolt and flange lock nut from LinkBag1. *The bolt will need to be installed as shown with the threads pointing forward.* **See Photo 34.**



Install new sway link in upper mount.

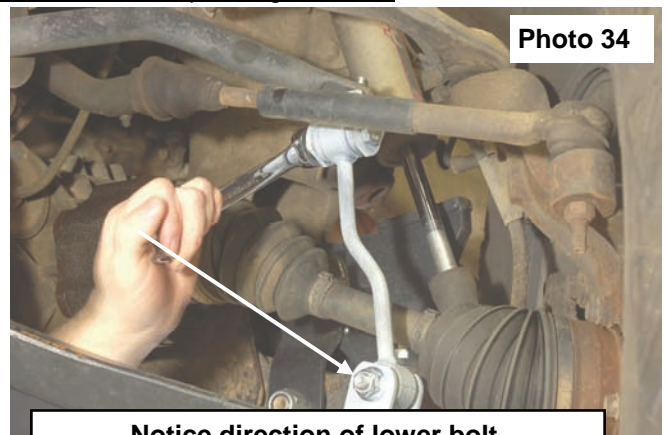

Notice direction of lower bolt.

41. Using a torsion bar tool, load the torsion bars using the mark made earlier as a reference.
42. Install front shock **Part #658734** in the factory lower location as shown in **Photo 35** with factory hardware and using a 21mm wrench. Install the shock in the upper mount with supplied stem bushings, cup washers & nuts (283N2BAG2) using a 9/16" wrench.
43. Install the tires and wheels and jack up the vehicle to remove the jack stands. Lower the vehicle to the ground.
44. Tighten control arm hardware using a 18mm & 24mm wrench.

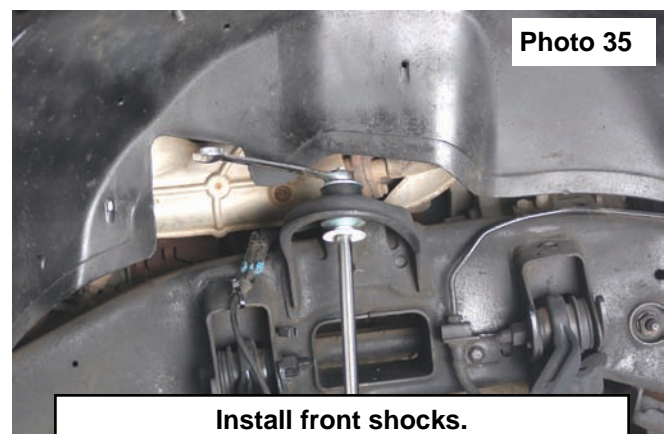

Install front shocks.

REAR INSTALLATION

1. Chock the front wheels and jack up the rear of the vehicle. Support the vehicle with jack stands. Remove the tires/wheels using 7/8" deep well socket.
2. Remove the factory shocks using a 21mm wrench and discard.
3. Support the rear axle with a floor jack and remove the factory u bolts.
4. Install the block on the axle and make sure the block and axle pin align. **See Photo 1.**
5. **As shown below for the 6" lift**, Install the supplied 7/16" u-bolts, washers, and nuts, from 1263Bag2, on the leaf springs, securing the block to the springs. Do not tighten at this time. **See Photo 2.**

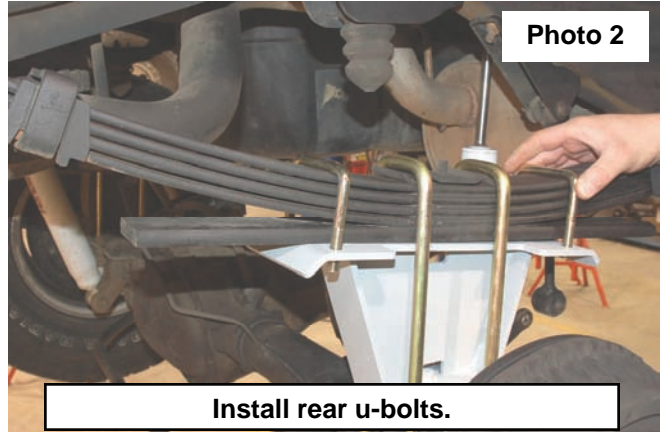

6. **On the 4" lift**, Install the 5" block between the leaf spring and axle.
7. Grinding may be required on the driver side e-brake bracket on the lower shock mount. If needed grind the threads to make sure there is no interference with the shock absorber.
6. Install the new shocks part # **658727** with the factory bolts and nuts using a 21mm wrench. **See Photo 3.** Note: The rear shock is a slim bore design due to limited clearance between the shock body and the axle tube.
7. Install the wheels and tires. Tighten lug nut to factory specifications using crossing pattern. Lower the vehicle to the ground.
8. Tighten the lug nuts to 85 ft lbs.



LOWER ARM TEMPLATE
(PLEASE CHECK TO MAKE SURE THE HOLE IS CENTERED PRIOR TO DRILLING)

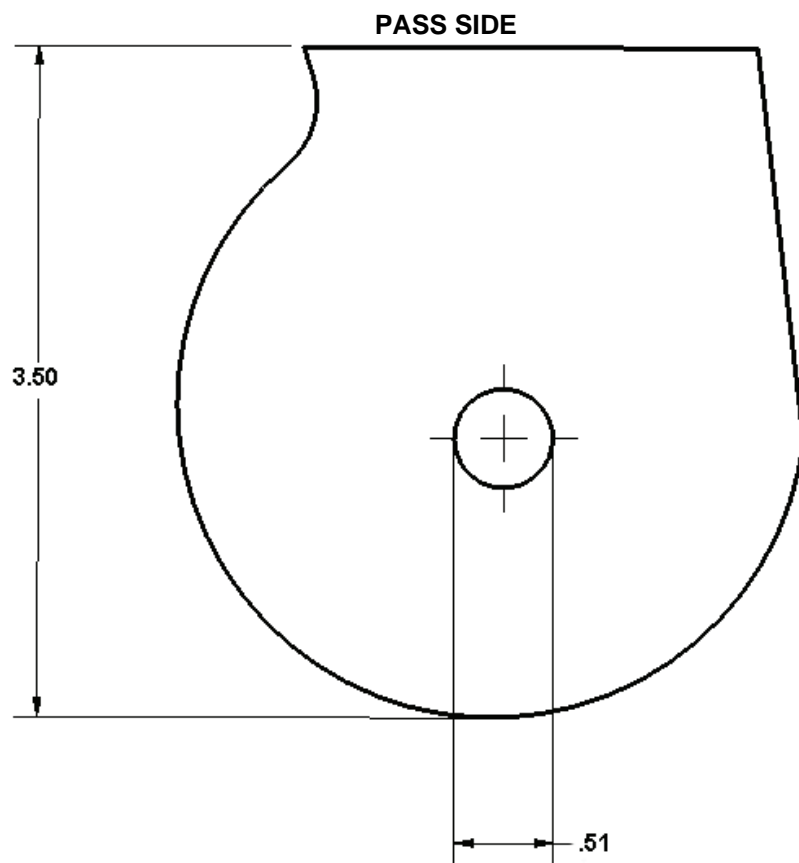
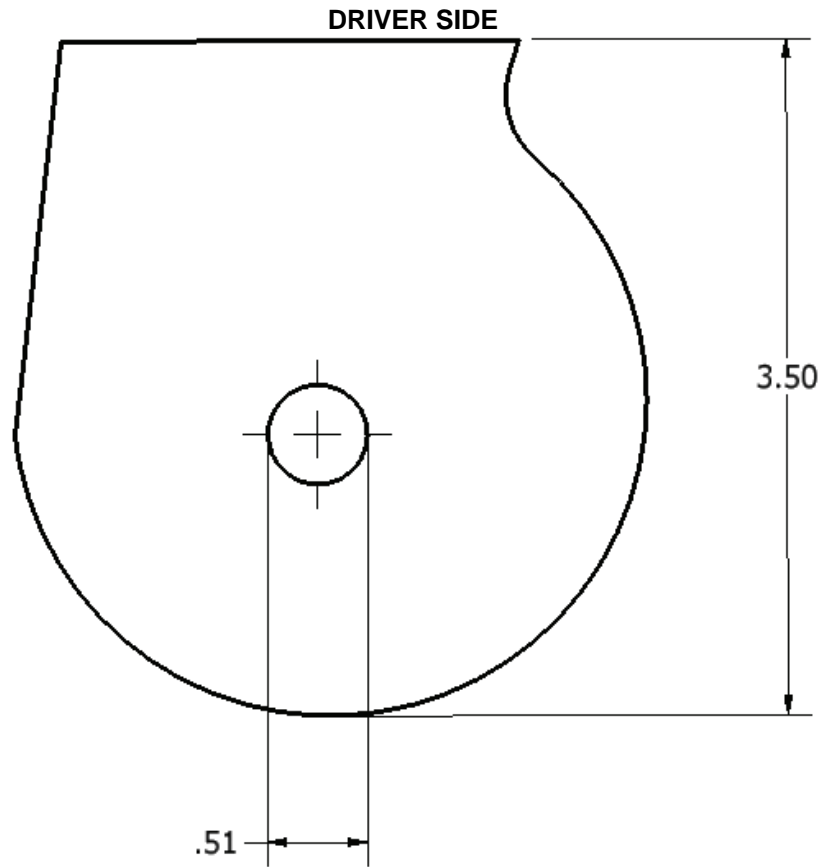

POST INSTALLATION INSTRUCTIONS

1. Check all fasteners for proper torque. Check to ensure for adequate clearance between all rotating, mobile, fixed, and heated members. Verify clearance between exhaust and brake lines, fuel lines, fuel tank, floor boards and wiring harness. Check steering gear for clearance. Test and inspect brake system.
2. On some vehicles the front lower skirting will need to be trimmed if using certain wheel /tire combinations and with heavy offset wheels. Trim only as needed.
3. Activate four wheel drive system and check front hubs for engagement.
4. Have a qualified alignment center align the vehicle immediately. Realign to factory specifications. Have headlights adjusted to proper settings.
6. Perform head light check and adjustment to proper settings.
7. Check and retighten wheels at 50 miles and again at 500 miles.
8. Recheck lifted height and adjust torsion bar as necessary.
9. All kit components must be retightened at 500 miles and then every three thousand miles after installation. Periodically check all hardware for tightness.
10. Install "Warning to Driver" decal on sun visor.

▲ NOTICE

Installation of larger tires will require speedometer recalibration.

OPTIONAL EQUIPMENT

Rough Country offers two optional items for this vehicle when lifted with our suspension system. Both of these items are highly recommended, but not required. Part # 87320 is a single steering stabilizer kit and will help with 35" tires to reduce front end wander and steering integrity. Also available is a set of kicker braces that add stability to the frame for off road performance. Please contact your Rough Country distributor to order.

Optional Equipment: Part # 1272 Box4-Kicker Braces



Thank you for choosing Rough Country for all of your suspension needs.

By purchasing any item sold by Rough Country, LLC, the buyer expressly warrants that he/she is in compliance with all applicable Federal, State, and Local laws and regulations regarding the purchase, ownership, and use of the item. It shall be the buyers responsibility to comply with all Federal, State and Local laws governing the sales of any items listed, illustrated or sold. The buyer expressly agrees to indemnify and hold harmless Rough Country, LLC for all claims resulting directly or indirectly from the purchase, ownership, or use of the items.

