



300 W. Pontiac Way Clovis, CA 93612 toll free: 1-800-445-3767 web: [www.belltech.com](http://www.belltech.com)

## 07-15 GM 1500 7" Lift Kit

**Thank you for being selective enough to choose our high quality BELLTECH PRODUCT. We have spent many hours developing our line of products so that you will receive maximum performance with minimum difficulty during installation**

Note: Confirm that all of the hardware listed in the parts list is in the kit. **Do not** begin installation if any part is missing. Read the instructions thoroughly before beginning this installation.

**Warning: DO NOT** work under a vehicle supported by only a jack. Place support stands securely under the vehicle in the manufacturer's specified locations unless otherwise instructed.

**Warning: DO NOT** drive vehicle until all work has been completed and checked. Torque all hardware to specified values.

Reminder: Proper use of safety equipment and eye/face/hand protection is absolutely necessary when using these tools to perform procedures!

Note: It is very helpful to have an assistant available during installation.

Note: Please refer to component and hardware list before beginning installation to insure all necessary pieces have been supplied and packaged.

### **Exceptional Customer Experience Guarantee:**

**STOP!** We strive for an exceptional experience for all of our valued customers. If, for any reason, you need assistance with your Belltech products, please do not return the products to the store or website you purchased from. Please call our dedicated experts at (1-800-445-3767) from 7am to 5pm PST.

### **RECOMMENDED TOOLS:**

- Properly rated Vehicle hoist or floor jack and support stands
- Wheel chocks
- Torque wrench up to 200 ft/lbs range
- Standard and Metric socket wrench set
- Standard and Metric wrench set
- Tape measure
- Dead blow hammer
- Marking pen
- Safety Glasses
- Breaker bar
- Sawzall with Metal cutting blades

**CAUTION!**

**BEFORE INSTALLING, ENSURE THAT YOU HAVE THE RIGHT KIT FOR YOUR APPLICATION.  
FAILURE TO DO SO WILL RESULT IN POOR FIT AND FAILURE OF PARTS  
IF NOT CORRECT, RETURN AND ORDER PROPER KIT.**

If your vehicle came equipped with either the aluminum upper control arm or steel tube upper control arm commonly equipped (but not limited to) to the 15-18 models the proper kit is following:

**150200 for the 4" lift kit**

**150203 for the 7" lift kit**

The CHEVROLET Stamped Steel Upper control arm superseded the Aluminum upper control arm.



**ALUMINUM UPPER CONTROL ARM**



**STAMPED STEEL UPPER CONTROL ARM**

If your vehicle came equipped with the cast steel upper control commonly equipped (but not limited to) to the 07-15 models the proper kit is following:

**150207 for the 4" lift kit**

**150201 for the 7" lift kit**



**CAST STEEL UPPER CONTROL ARM**

QTY	Part #	Description
1	<b>150201-101</b>	Front Cross Member
1	<b>150201-102</b>	Rear Cross Member
2	<b>150201-112</b>	LCA Supports
1	<b>150201-115</b>	Support Plate
1	<b>150201A-777</b>	Crossmember Hardware Kit
2	110218	M16 x 2 - 120mm
2	110281	M16 x 2 - 140mm
8	110219	M16 Washer
4	110242	M16 Nylock Nut

1	<b>150201-103D</b>	Left Spindle
1	<b>150201-103P</b>	Right Spindle
2	<b>150201-209</b>	CV Axel Spacer
2	<b>150201-150</b>	Tie Rod End
2	<b>150201-204</b>	Space Wheel Spacer
1	<b>150201B-777</b>	CV Axel Hardware Kit
12	110285	M10 x 1.5 - 60mm

2	<b>28004</b>	Lifting Strut
1	<b>150201C-777</b>	Lifting Strut Hardware Kit
4	110237	M10 x 1.50 - 70mm
4	110238	M10 X 1.50 Nylock
8	110239	M10 Washer

1	<b>150201-104</b>	Diff Drop (Drivers)
1	<b>150201-105</b>	Diff Drop (Pass)
1	<b>150201D-777</b>	Differential Drop Hardware Kit
2	110283	M14 X 2 - 45mm Bolt Flange
2	110222	M14 x 2 Nuts
2	110223	M14 Washer
2	110282	M12 x 1.75 45mm Bolt
2	110243	M12 x 1.75 Nuts
4	110228	M12 Washer

2	<b>150201-106</b>	Compression Arms
2	<b>150201-107F</b>	Bracket
2	<b>150201-107R</b>	Bracket
1	<b>150201-100-HW</b>	Bushing Kit
1	<b>150201E-777</b>	Compression Arms Hardware Kit
4	110227	M12 x 1.75 - 110mm Bolt
12	110228	M12 Washer
6	110243	M12 x 1.75 Nylock Nut
2	110225	M12 x 1.75 - 30 mm

1	<b>150201-108</b>	Skid Plate
1	<b>150201F-777</b>	Skid Plate Hardware Kit
1	110226	M12 x 1.75 - 100mm Bolt
1	110243	M12 x 1.75 Nylock Nut
3	110228	M12 Washer
1	110225	M12 x 1.75 - 30mm

2	<b>2216FF</b>	Rear Shock
4	<b>150201-202</b>	U-bolt
2	<b>150201-201</b>	Lifting Block
1	<b>150201G-777</b>	U-bolt Hardware Kit
8	110240	9/16"-18 Nylock Nut
8	110241	9/16 Washer

1	<b>150201-211R</b>	Brake line Bracket
1	<b>150201-211L</b>	Brack line Bracket
1	<b>150201H-777</b>	Brake line Bracket Hardware Kit
4	110286	M6x1 - 25mm
4	110235	M6x1 Nylock
8	100117	M6 Washer

1	<b>5427</b>	Front Anti-Sway Bar Kit
---	-------------	-------------------------



## 1) KIT PREPERATION

- a) Before beginning the install process, measure the hub to fender heights for your vehicle so you can compare the resulting height to the original. Measure vertically from the center of the wheel to the inner edge of the fender. Record the results here:

LF: \_\_\_\_\_ RF: \_\_\_\_\_

LR: \_\_\_\_\_ RR: \_\_\_\_\_

- a) Park the vehicle on a smooth, level concrete or seasoned asphalt surface and activate the parking brake. Block the REAR wheels of the vehicle with appropriate wheel chocks; making sure the vehicle's transmission is in 1st gear ( manual) or "Park" (automatic).

! It is very important that the vehicle is properly supported during this installation to prevent personal injury and chassis damage. Make sure that the support stands are properly placed prior to performing the following procedures. We **DO NOT RECOMMEND** using wheel ramps while performing this installation. !

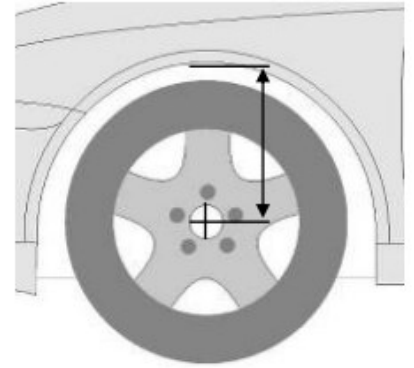

## 2) FRONT INSTALL INSTRUCTIONS

- a) Using a vehicle hoist is recommended. If no hoist is available, jack up the front of the vehicle. Place jack stands under the frame rails and lower onto jack stands letting the front suspension hang.
- b) Use the appropriate socket to undo the lug nuts and remove the wheels. **(PHOTO 1)**
- c) Remove the sway bar from the vehicle completely by disconnecting it from the end link using a 15m wrench & socket, and removing the brackets using a 10mm socket. **(PHOTO 2)**
- d) Using a 21mm wrench, remove the tie-rod nut. Strike the side of the mount with a dead blow hammer to dislodge the tie rod end. A 10mm wrench may be needed if the ball joint is spinning. **(PHOTO 3)**
- e) Using a 10mm wrench and panel poppers, remove all mounting points for the brake line including the bracket on the knuckle and abs sensor wire from the control arm and spindle. Undo the brake caliper mounting bolts located at the back of the assembly with an 18mm socket and remove them, hang the calipers to prevent stretching of the lines using large zip ties or hangers. Remove the rotors by removing the T30 Torx screw and put it to the side. **(PHOTO 4)**

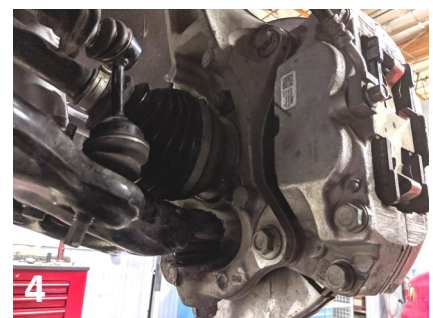

## 2) FRONT INSTALL INSTRUCTIONS CONTINUED

3)

- f. Remove and unplug the ABS sensor wire from the spindle. Use a 5mm allen for the ABS Sensor. **(PHOTO 5)**
- g. Remove the axle nut located underneath the dust cap using a 36mm socket. This will help prevent the axle from pulling out of the differential and causing damage. **(PHOTO 6)**
- h. Support the spindle by gently lifting against it with a jack. This is to prevent the spindle assembly from falling during the next two steps.
- i. Loosen the upper ball joint nut using a 19mm wrench. Strike the spindle on the designated bosses to help separate the upper control arm from the spindle. Remove Nut. Be careful, the upper control arm could be under tension. Allow the spindle to droop as you slide the axle shaft out of the hub. **(PHOTO 7)**
- j. Remove the lower ball joint nut using a 24mm wrench and strike it on the designated bosses to separate from the lower control arm. Be sure to hold the spindle as it breaks free to prevent damage. **(PHOTO 8)**
- k. Uninstall the strut. The top nuts can be removed with an 18mm wrench. Remove the hardware holding the bottom of the strut to the control arm using a 15mm socket and remove the strut from the vehicle. **(PHOTO 9)**
- l. Remove the CV axle by removing the 6 bolts attaching it to the front differential using a 15mm socket. **(PHOTO 10)**

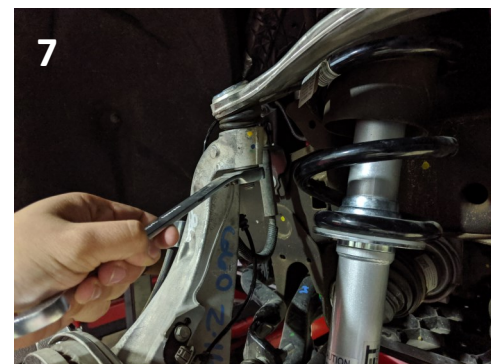

## 2) FRONT INSTALL INSTRUCTIONS CONTINUED

- m. Remove the lower control arms from the frame using an 18 & 24mm socket. A breaker bar may be required. **(PHOTO 11)**
- n. Remove the OEM equipped plastic gravel guards.
- o. Disconnect the three electrical connections, rubber vent hose and the driveshaft from the differential **(PHOTO 12)**
- p. Remove the 4 bolts and nuts holding the crossmember underneath the differential, and remove the crossmember. **(PHOTO 13)**
- q. Locate the front tab in which the lower control arm mount. Trim the area marked in *photo 14* for both sides. This is necessary for the front crossmember to install. **(PHOTO 14)**
- r. Reference *photo 16* for the next step. Measure 3/4" from the edge of hole A, and mark a vertical line to cut the area of the crossmember that will interfere with the differential. **ONLY NEEDED FOR REAR DRIVER'S SIDE MOUNT.** **(PHOTO 15 & 16)**
- s. It is recommended that you remove the differential completely before continuing on with the procedures. Regardless of procedure, ensure the differential is always supported.
- t. Install the differential drop spacers to the frame using OEM hardware. Both diff drops should have the tapered end toward the rear of the vehicle and the flat faces facing inward.
- u. Raise and install the differential, reconnect driveshaft and electrical connections. The differential attaches to the drops using the supplied M14 hardware found within the 150201D-777 packet.

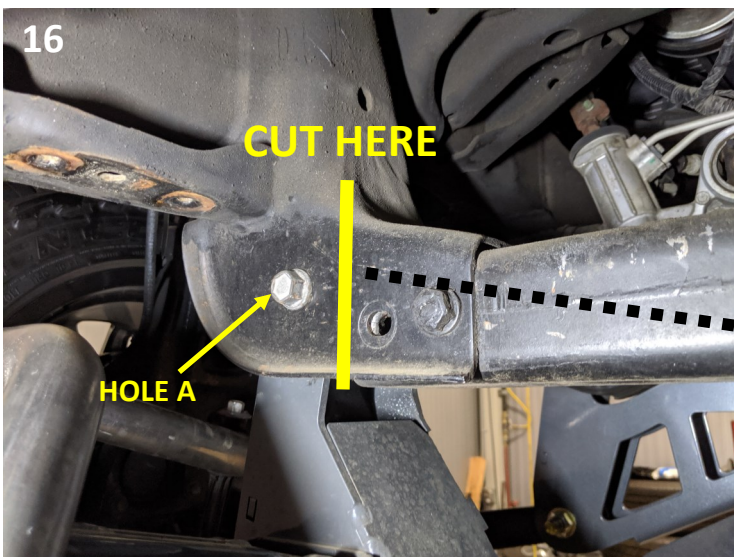
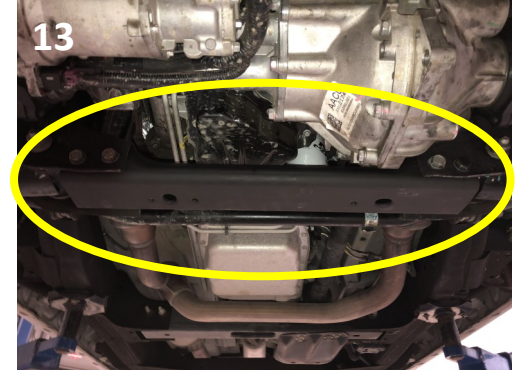

### 3) FRONT INSTALL CONTINUED

- w. Install the front and rear crossmembers using OEM hardware and torque to 130 ft-lb. **(PHOTO 17/18)**
- x. Install the OEM lower control arms into the front and rear crossmembers using the supplied M16 Bolts found within the 150201A-777 packet. . Install the Lower A frame support rods. They will connect between the front and rear crossmembers and attach using the same hardware as the lower control arms. **(PHOTO 19)**
- y. Install the CV axles with the spacers between the mounting hub and the differential mounting plate. Use the 12 supplied extended CV axle bolts found within the 150201B-777 hardware packet.
- z. Install the new sway bar by the frame mounts. Use the supplied bushing hardware and OEM bolts. Refer to the provided instructs for additional information.
- aa. Refer to the supplied 28004 instructions for strut assembly, desired height and ring position. Use the supplied M10 hardware found in 150201C-777 packet to mount the lower bushing to OEM control arm. **(PHOTO 20)**
- bb. Remove the tie rod end and replace with the supplied tie rod end. **(PHOTO 21)**
- cc. Remove the hub and brake backing plate from the factory spindle. Install on the lift spindle. **(PHOTO 22)**
- dd. Install the assembled lift spindle in the reverse order of the de-installation, making sure the axle shaft does not pull out of its mounting point on the differential. Tighten the axle nut to 180ft-lbs.
- ee. Torque the upper and lower ball joints to 85 ft-lbs.

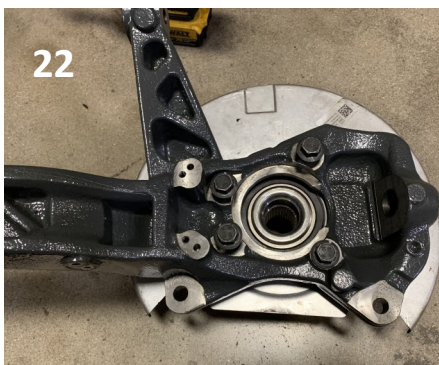
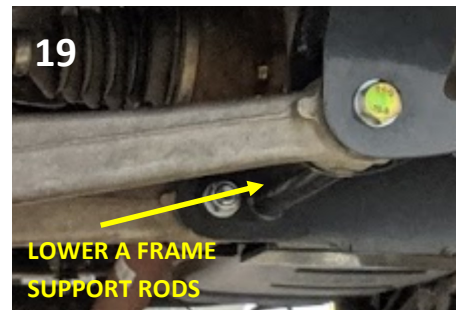



## 2) FRONT INSTALL INSTRUCTIONS CONTINUED

- gg. Reinstall the ABS harness, sensor, rotor and brake calipers using the OEM hardware in reverse process of deinstallation.
- hh. install the outer tie rod to the spindle using the supplied hardware. Torque to 65 ft-lbs. **(PHOTO 23)**
- ii. Remove the brake line brackets by the top of the strut tower and install the brake line relocation brackets
- jj. Reconnect the sway bar end links back to the lower control arm and sway bar using factory hardware. Torque to 35 ft-lbs. **(PHOTO 24)**
- kk. Install the skid plate using the supplied M12 hardware within the 150201F-777 kit and torque to 50 ft-lbs on the front crossmember, 30 ft-lbs on the rear crossmember. **(PHOTO 25)**
- ll. Using a 21mm socket remove the two nuts holding the crossmember located towards the center of the vehicle and install the rear compression arm bracket. The crossmember does not get removed so removing the bolts is not necessary. Factory hardware is retained. Also mount the front compression arm brackets to the rear crossmember using the supplied hardware within the 150201E-777 packet.. **(PHOTO 26)**
- mm. Assemble the compression arms by pushing the supplied bushings into each end and pressing in the center tube found in 150201-100-HW bag . Once assembled mount the compression arms into the brackets and using the remaining hardware supplied in the 150201E-777. Swing the front of the compression arms up and attach them to the rear crossmember in similar manner to the rear of the arms. Torque to 100 ft-lbs. **(PHOTO 27)**
- nn. Mount the brake line to the upper control arm as shown using the front brake line relocation bracket and the supplied bolt within the 150201H-777 packet.
- oo. Install wheel and lower the front of the vehicle to the ground. The front installation is complete. Check that all hardware is torqued and installed properly.



### 3) Rear Lift Installation

- a) If not using a hoist, chock the front wheels to prevent the vehicle from moving while the rear end is lifted.
- b) Jack up the rear of the vehicle from the differential.
- c) Place jack stands under the frame rails and lower the vehicle onto the jack stands carefully.
- d) Remove the wheels.
- e) Remove the factory shock absorbers using a 21mm wrench & socket. The factory hardware will be reused. **(PHOTO 28)**
- f) Remove the factory u-bolts and carrier plates by evenly undoing the nuts using a 21mm socket, then remove the factory blocks. Slowly lower the axle to allow for the new lift block to be installed. **(PHOTO 29)**
- g) Install the block on the factory spring pad with the flat part of the block on the spring and the tapered end towards the front. Jack up the axle to meet the springs, making sure to align the center pin. **(PHOTO 30)**
- h) With the floor jack applying slight pressure to the rear axle to keep the pin aligned, install the new supplied u-bolt hardware found within the 150201G-777 packet and tighten in a crossing pattern.
- i) Locate the new shock absorbers, and install the shock absorbers in the factory mounting locations using the factory hardware. Tighten using a 21mm wrench & socket. **(PHOTO 31)**
- j) Reattach the brake lines and harness wherever they were undone from their factory locations to create slack. Ensure that once reinstalled, none of the brake lines are being stretched before continuing.
- k) Install the tires/wheels.
- l) Jack up the vehicle to remove the jack stands. Remove the jack stands and lower the vehicle to the ground.
- m) The rear installation is now complete.

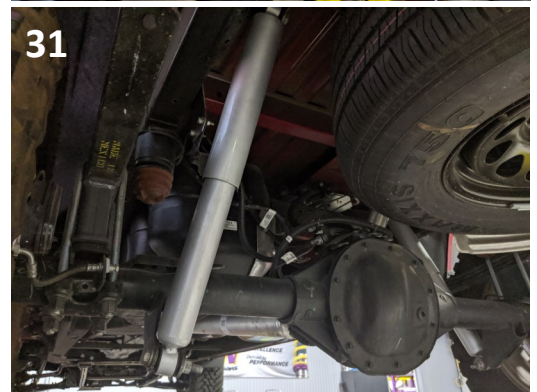

## 4) Post Install

- a) Check that all components and fasteners have been properly installed, tightened and torqued.
- b) Check brake hoses, and other components for any possible interference.
- c) Torque lug nuts to OEM ( factory) specifications.
- d) Test drive the vehicle in a remote location so that you can become accustomed to the altered driving characteristics and handling. Be aware that the vehicle will handle substantially different now that it has been modified.
- e) We recommend the vehicle be taken to a qualified wheel alignment facility to be realigned to factory specifications after completing the install.
- f) Installation is complete. Check ALL of the hardware and re-torque at intervals for the first 10, 100, 1000 miles.

