



Nissan 2022 Frontier 2wd/4wd 6" Kit

Thank you for choosing Rough Country for all of your suspension needs.

Rough Country recommends a certified technician installs this system. In addition to these instructions, professional knowledge of disassemble/reassembly procedures as well as post installation checks must be known. Attempts to install this system without this knowledge and expertise may jeopardize the integrity and/or operating safety of the vehicle.

Please read all the instructions before beginning the installation. Check the kit hardware against the Kit Contents list on next page. Be sure you have all the needed parts and understand where they go. Also please review the tools needed list to be certain that you have the tools necessary to complete the installation.

PRODUCT USE INFORMATION

⚠ WARNING

As a general rule, the taller a vehicle is the easier it will roll. We strongly recommend, because of rollover possibility, that seat belts and shoulder harnesses should be worn at all times. Avoid situations where a side rollover may occur. Braking performance and capabilities are decreased when significantly larger/heavier tires and wheels are used. Take this into consideration while driving. Also, speedometer recalibration is necessary when larger tires are installed.

Do not add, alter, or fabricate any factory or after-market parts which increase vehicle height over the intended height of the Rough Country product purchased. Mixing component brands, lifts, with this suspension lifts voids all warranties. Rough Country makes no claims regarding lifting devices and excludes any and all implied claims. We will not be responsible for any product that is altered.

⚠ NOTICE

Due to differences in manufacturing, dimension and inflated measurements, tire and wheel combinations should be test fit prior to installation. A quality tire of radial design is recommended. **Factory wheels will not fit.**

We recommend, at minimum, an 18" wheel, or larger, not to exceed 9" in width with **5" of backspacing/ 0" offset** and up to a **285/65R-18** tire.

⚠ NOTICE NOTICE TO DEALER AND VEHICLE OWNER

Any vehicle equipped with any Rough country product must have the "Warning to Driver" decal installed on the sun visor or dash. The decal is to act as a constant reminder for whoever is operating the vehicle of its unique handling characteristics. **INSTALLING DEALER**—It is your responsibility to install the warning decal and to forward these installation instructions on too the vehicle owner for review and to be kept in the vehicle for its service life.

We hope installing your Rough Country lift kit is a positive experience. Please note that variations in construction and assembly in the vehicle manufacturing process will virtually ensure that some parts may seem difficult to install. Additionally, the current trend in manufacturing of vehicles results in a frame that is highly flexible and may shift slightly on disassembly prior to installation. The use of pry bars and tapered punches for alignment is considered normal and usually does not indicate a faulty product. However, if you are uncertain about some aspect of the installation process, please feel free to call our tech support department at 800-222-7023. We do not recommend that you modify the Rough Country parts in any way as this will void any warranty expressed or implied.



KIT CONTENTS

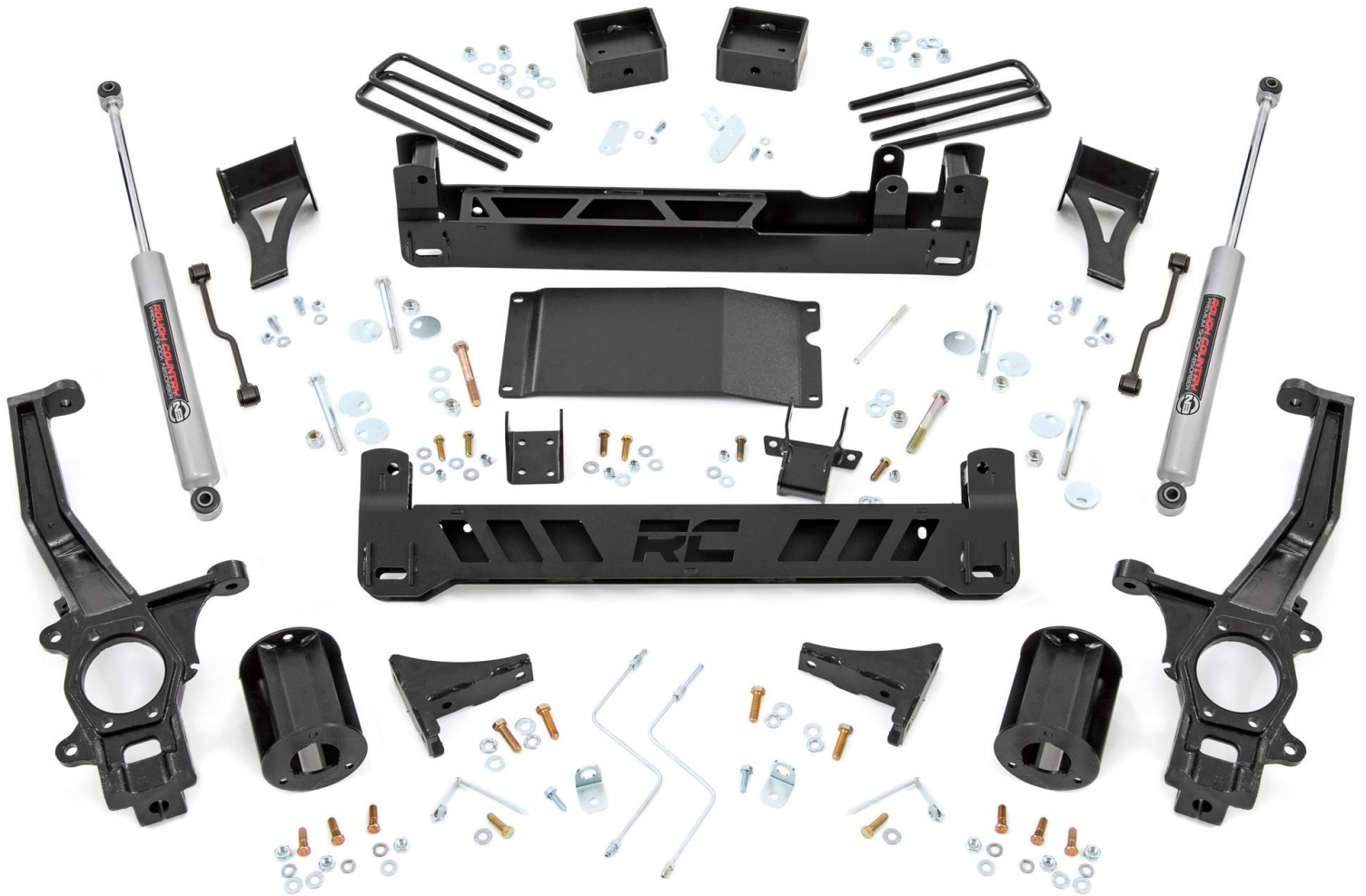

Kit Contents:**83700BOX1:**

Dr Knuckle
Pass Knuckle

83730BOX2:

1879BAG1
Front Dr Diff Bracket
Front Pass Diff Bracket
Skid Plate
Sway Bar Drop Brackets-2
Brake Lines-2
Dr Bump Stop Ext
Pass Bump Stop Ext
1879BAG2
Rear Blocks-2
Ubolts-4
Rear Shocks-2
1879BAG3
Strut Spacers-2
10MMSTUDBAG-1
1879BAG4
Sway Bar Links-2
1875BAG5
83730BAG

1879Box3:

Front Crossmember
Rear Crossmember

Fastener Breakdown:**1879BAG1:**

Cam Bolts-4
Cam Washers-8
14mm Nylock Nuts-4
9/16" x 4" Bolt-1
9/16" Flat Washer-6
9/16" Nylock Nut-1
1/4" Vent Hose-4"
1/4" Vent Hose Coupler

1879BAG2:

3/8" x 1.25" Bolts-12
3/8" Flat Washers-22
3/8" Nylock Nuts-6
9/16" x 4" Bolt-1
9/16" Flat Washers-2
9/16" Nylock Nut-1
5/16" x 1" Self Tap Bolts-2
3/8" Lock Washers-6
3/8" Flange Lock Nuts-4
7/16" x 1.5" Bolts-4
7/16" Lock Washer-4
7/16" Flat Washers-4
3/8" x 1" Bolts-4

1879BAG4:

5/16" x .75" Bolts-2
5/16" Flat Washers-2
5/16" Flange Lock Nuts-2
Cable Tie-2
Front Brake Line Brackets-2
Center E Brake Bracket
Pass E Brake Bracket
Bump Stop Flag Nuts-2

10MMSTUDBAG-1

1/2" Jam Nut
10mm Nuts-7
10mm Studs-6
10mm Lock Washers-6
10mm Flat Washers-6

Fastener Breakdown:**9/16BAG:**

9/16" Flat Washer-8
9/16" Nylock Nuts-8

1875BAG5:

12MM x 65MM Bolts-4
12MM Flange Nuts-4
12MM Flat Washer-4
Sleeves-4

83730BAG:

Instructions-1

TOOLS NEEDED:**Torque Specs:**

Size	Grade 5	Grade 8
5/16"	15 ft/lbs	20 ft/lbs
3/8"	30 ft/lbs	35 ft/lbs
7/16"	45 ft/lbs	60 ft/lbs
1/2"	65 ft/lbs	90 ft/lbs
9/16"	95 ft/lbs	130 ft/lbs
5/8"	135 ft/lbs	175 ft/lbs
3/4"	185 ft/lbs	280 ft/lbs
	Class 8.8	Class 10.9
6MM	5 ft/lbs	9 ft/lbs
8MM	18ft/lbs	23 ft/lbs
10MM	32ft/lbs	45ft/lbs
12MM	55ft/lbs	75ft/lbs
14MM	85ft/lbs	120ft/lbs
16MM	130ft/lbs	165ft/lbs
18MM	170ft/lbs	240ft/lbs

5mm Allen
10mm socket /wrench
14mm socket /wrench
15mm socket / wrench
17mm socket / wrench
18mm socket /wrench
19mm socket/ wrench
21mm socket /wrench
22mm socket/ wrench
32mm socket/ wrench
Torque Wrench
File
Hammer
Drill Motor
1/4" Drill
19/32" Drill

1/2 socket/ wrench
5/8 socket/ wrench
9/16 socket /wrench
13/16 socket/ wrench
7/8 socket/ wrench
Loc-Tite
Reciprocating Saw
Floor Jack
Jack Stands
Pliers
Tape Measure
Black Paint
Phillips Head Screwdriver



INSTALLATION INSTRUCTIONS

1. Chock the rear wheels.
2. Jack up the front of the vehicle.
3. Place jack stands on the frame behind the lower control arms.
4. Lower the vehicle onto the jack stands and remove the tires and wheels using a 21mm socket.
5. Place the floor jack under the differential.
6. Remove the cotter pin from the tie rod end. **See Photo 1.**
7. Using a 22mm socket, loosen the tie rod nut. **See Photo 2.**

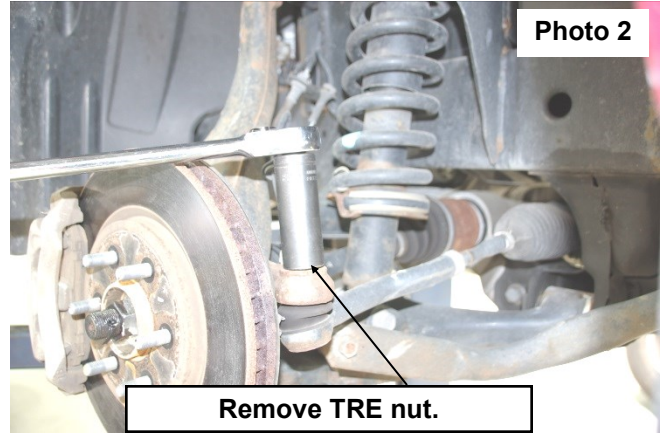
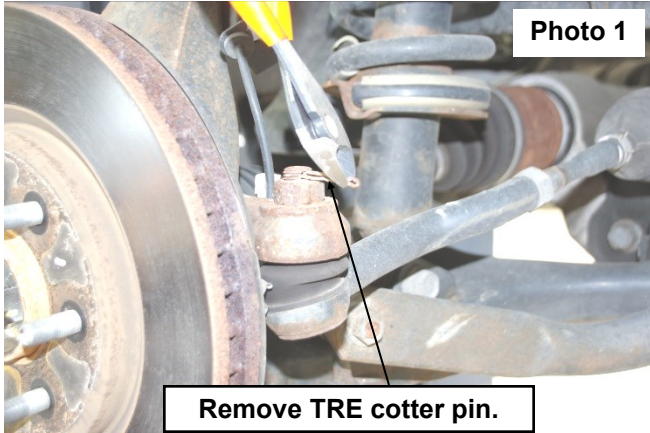

8. Using a hammer, strike the knuckle to release the tie rod end from the knuckle. Retain hardware. **See Photo 3.**
9. Using a 19mm socket, remove the brake caliper. **Do Not allow caliper to hang from brake line.** Retain the factory hardware. **See Photos 4 & 5.**

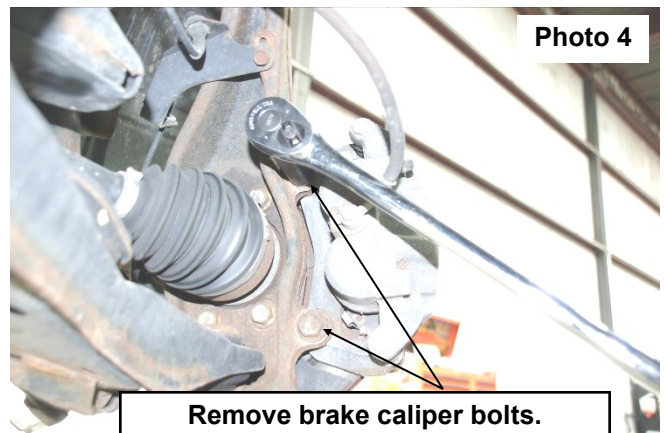
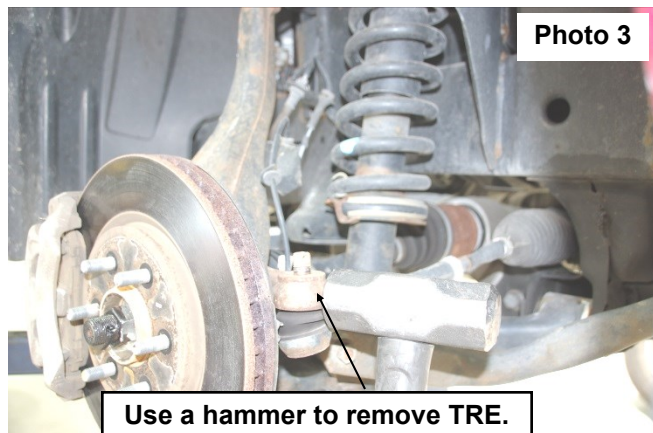

10. Remove the brake rotor from the hub assembly. **See photo 6.**

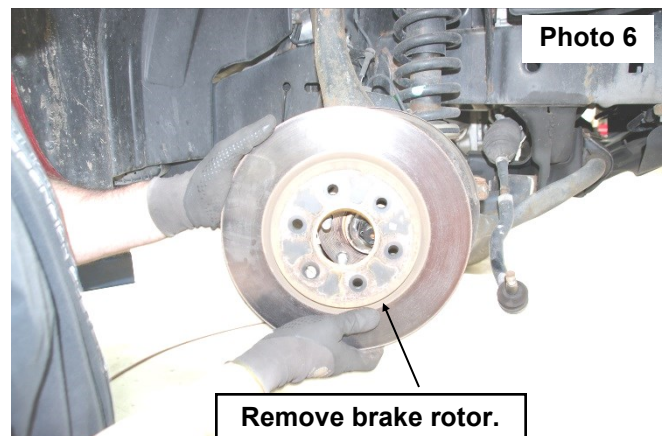
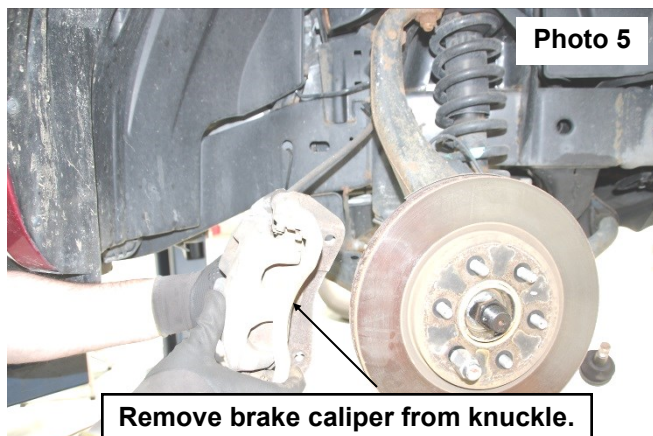

11. 2wd models, skip to step 13. Remove the cotter pin from the axle shaft.. See Photo 7

12. Using a 32mm socket, remove the axle nut. Retain for reuse. See Photo 8.

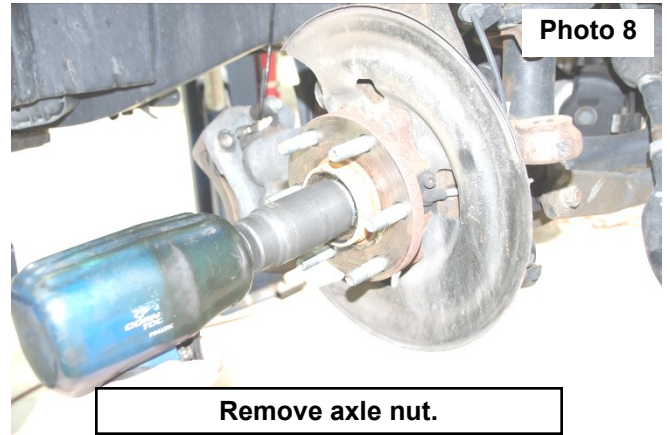
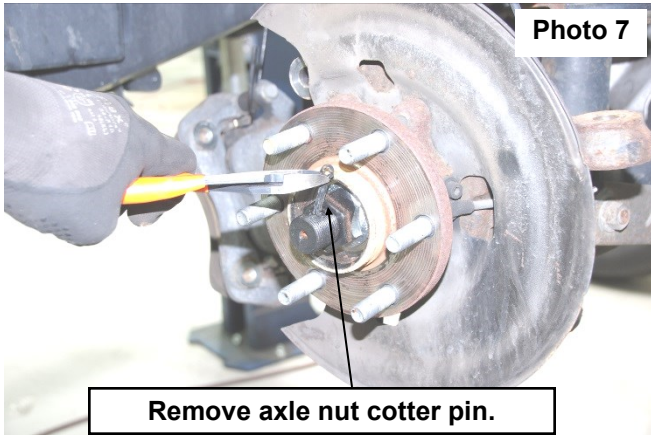

13. Using a 5mm Allen, remove the ABS sensor from the knuckles. See Photo 9.

14. Using a 10mm wrench, remove the ABS line bracket from the knuckle. Retain hardware for reuse. See Photo 10.

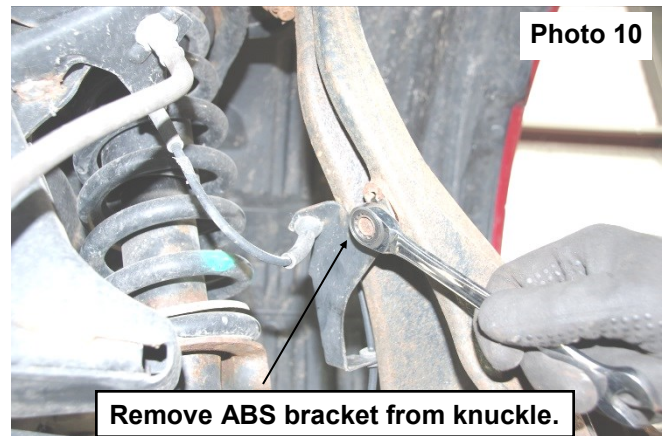
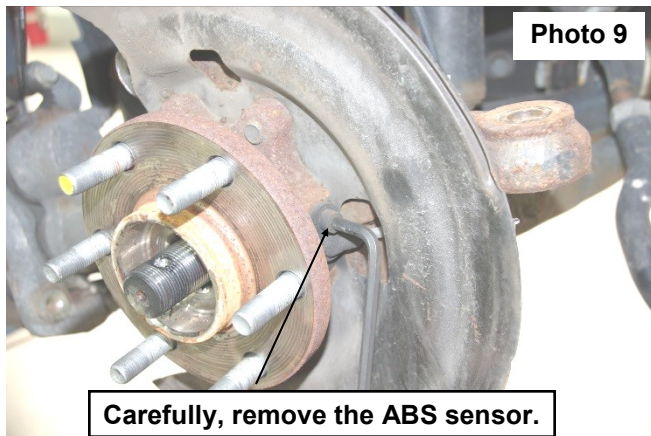

15. Unplug the ABS line at the frame and retain line for reuse. See Photo 11.

16. Remove the cotter pin from the upper ball joint. See Photo 12.

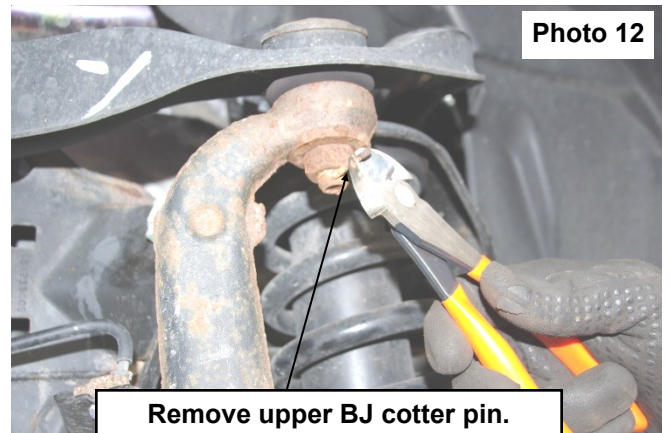
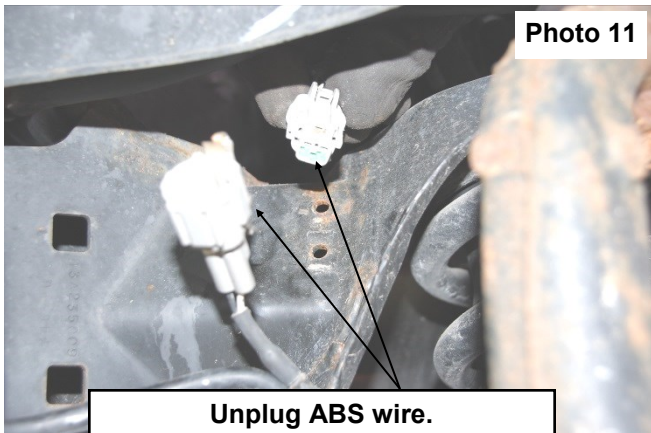

17. Using a 22mm wrench, loosen the upper ball joint nut. Do not remove. **See Photo 13.**

18. Strike the knuckle at the upper ball joint to release the taper. **See Photo 14.**

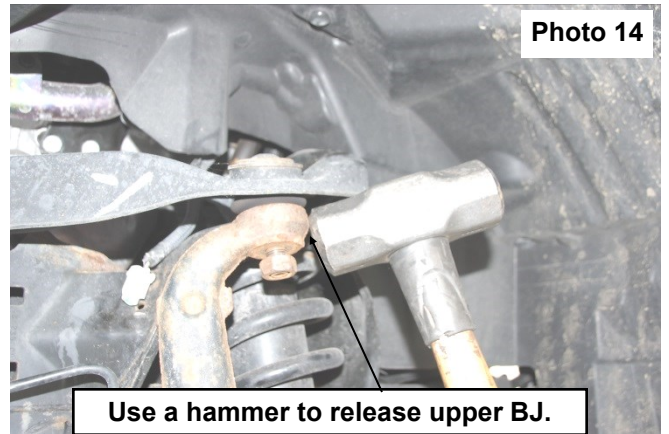
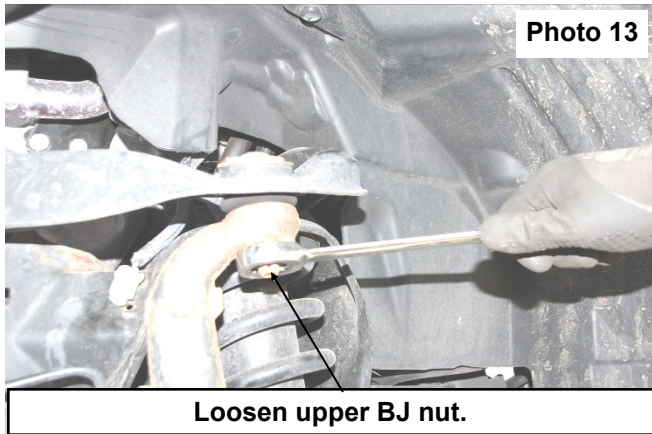

19. Using a 17mm wrench and 21mm socket, remove the pinch bolt from the lower ball joint. Retain for reuse. **See Photo 15.**

20. Remove the upper ball joint and remove the knuckle. **See Photo 16.**

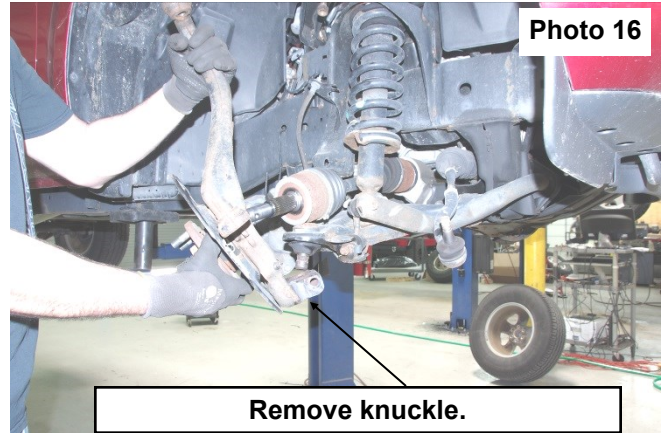
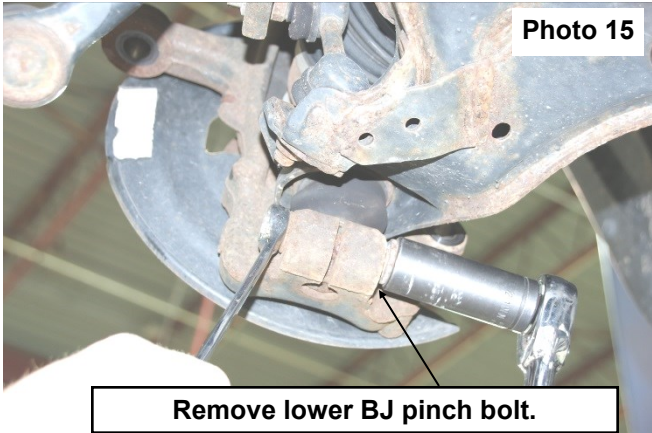

21. Using a 19mm socket and 22mm wrench, remove the sway link from the lower control arm. Retain hardware. **See Photo 17.**

22. Using 19mm wrenches, remove the lower strut bolt and retain for reuse. **See Photo 18.**

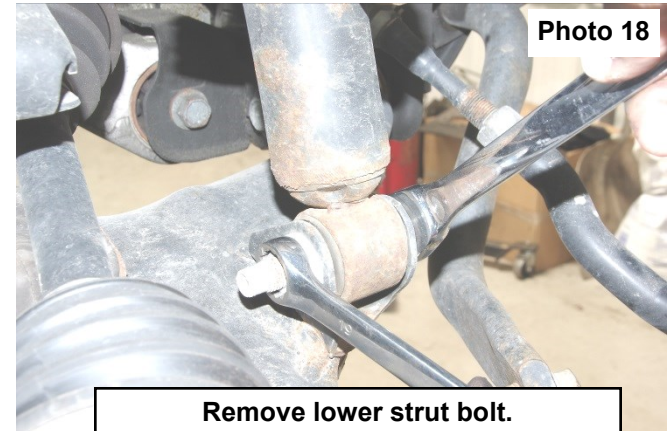

23. Using a 14mm wrench, remove the upper strut nuts and remove the strut. Retain hardware for reuse. **See Photo 19.**
24. Using a 19mm socket and 22mm wrench, remove the lower control arm. Retain the hardware for reuse. **See Photo 20.**

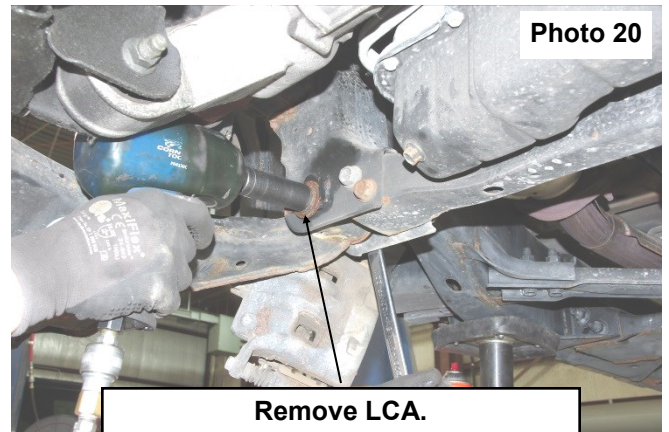
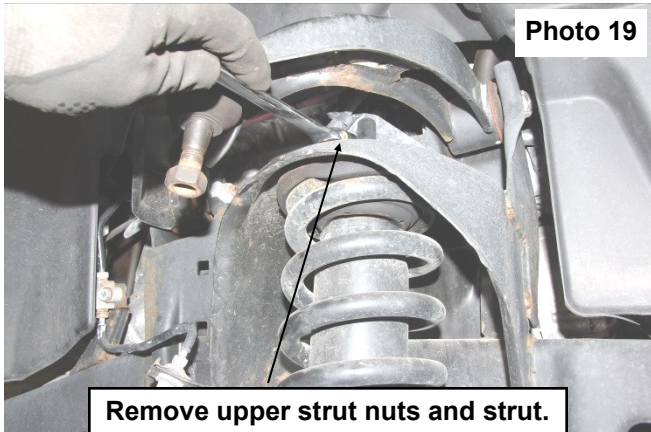

25. **2wd models, skip to step 35.** Using a 19mm socket and wrench, remove the rear crossmember.
26. Mark and remove the front driveshaft from the diff, using 14mm wrenches. Retain hardware for reuse. **See Photo 21.**
27. Support the differential using a jack.
28. Using a 19mm socket, remove the dr rear diff bolt and retain for reuse. **See Photo 22.**

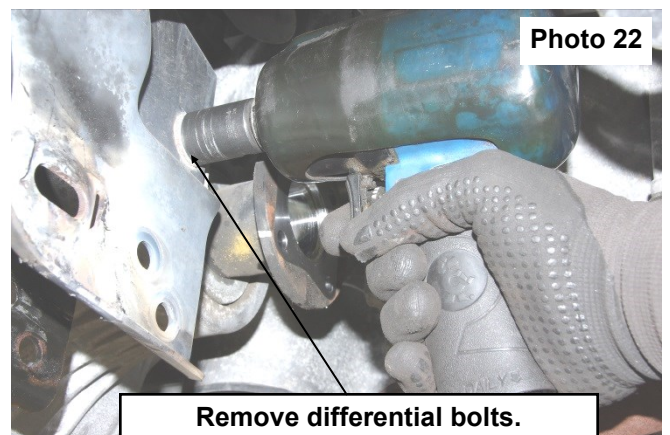
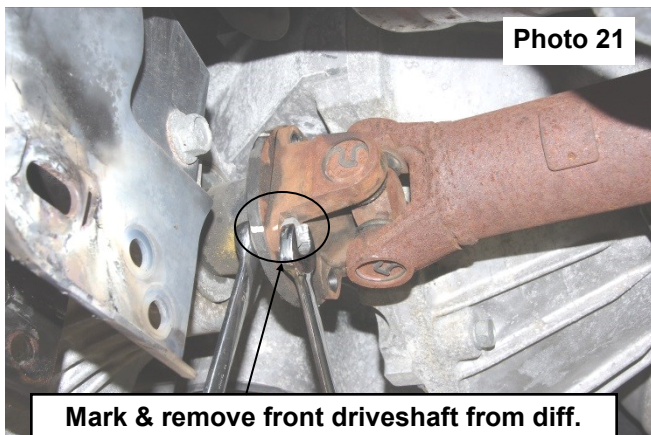

29. Using a 19mm socket and wrench, remove the front dr diff bolt. Retain hardware for reuse. **See Photo 23.**
30. Using a 19mm socket and wrench, remove the front pass diff bolt. Retain hardware for reuse. **See Photo 24.**
31. Unplug the vent tube and remove the differential from the truck.

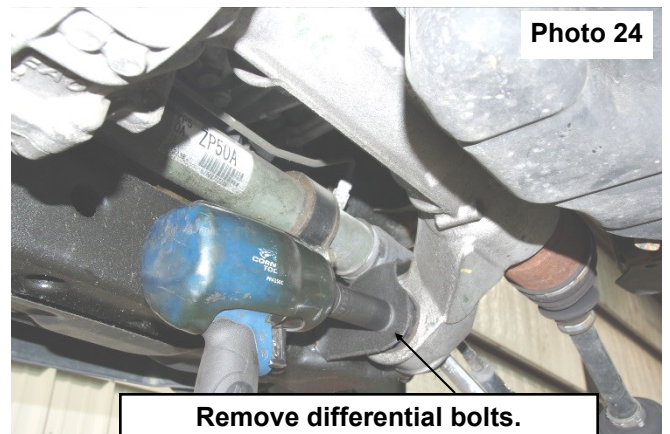
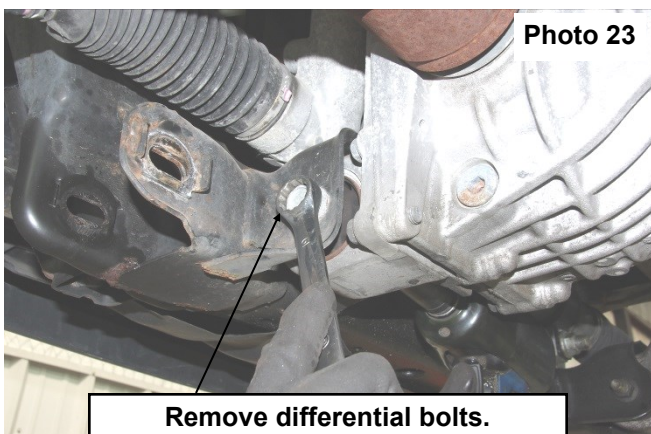

32. Using the supplied 3/8" x 1.25" bolts, washers, and nylock nuts (1879BAG2), attach the pass diff mount to the front crossmember. **See Photo 25.**
33. Using 9/16" wrenches, snug the diff mount bolts. **Do not fully tighten at this time. See Photo 26.**



Photo 25

Install pass frt diff mount.

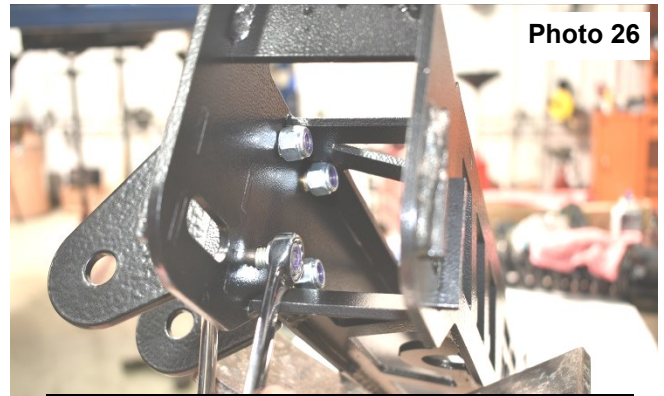

Photo 26

Snug diff mount bolts.

34. Using the supplied 3/8" x 1.25" bolts, washers, and nylock nuts (1879BAG2), attach the driver diff mount to the front crossmember. **Do not tighten at this time. See Photo 27.**
35. Locate the small tabs inside of the factory lower control arm pockets. **See Photo 28.**

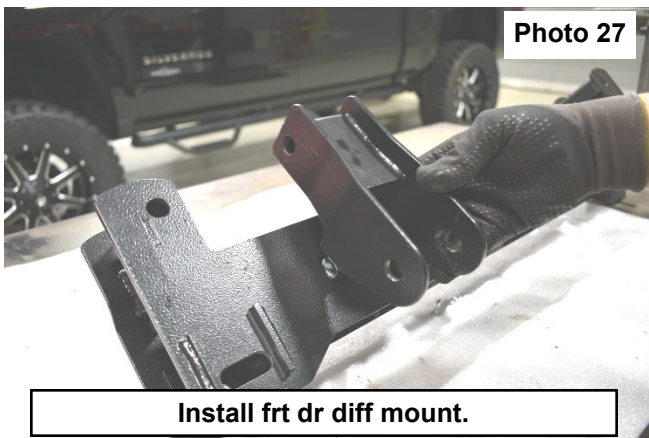

Photo 27

Install frt dr diff mount.

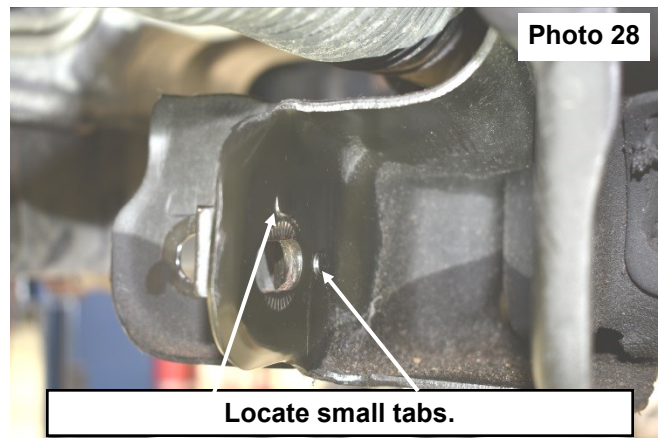

Photo 28

Locate small tabs.

36. Using a file, file the tabs smooth. **This will need to be done in all 4 lower control arm pockets. See Photo 29.**
37. **2wd models, skip to step 42.** On the factory rear crossmember mount. Measure over 2" and mark as shown in **Photo 30.**



Photo 29

File tab from all CA pockets.

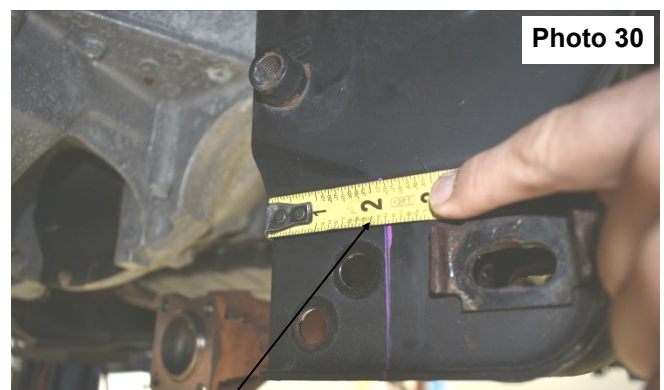
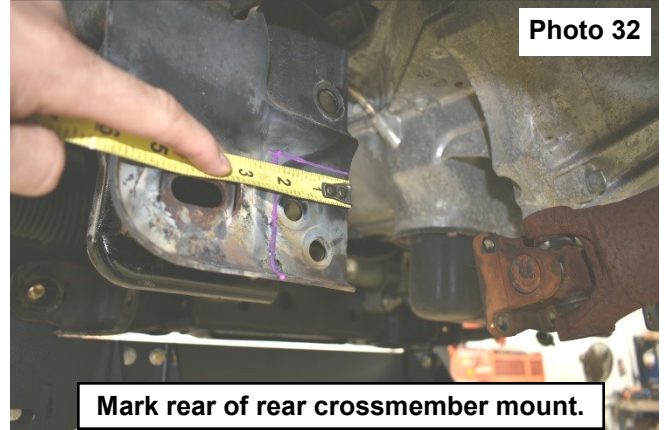
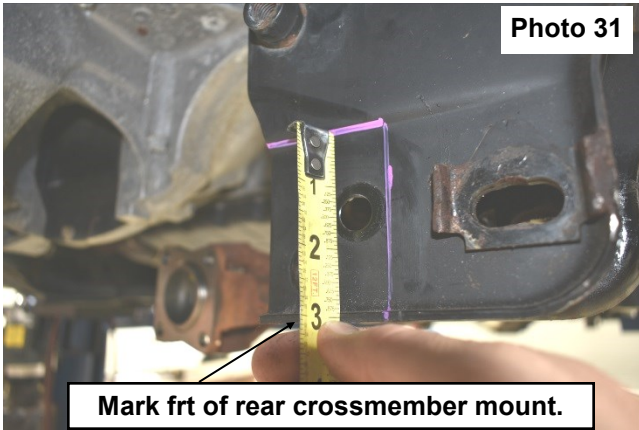

Photo 30

Mark frt of rear crossmember mount.

38. Measure 3" up from the bottom edge and mark as shown in **Photo 31**.
39. Repeat the same process on the back of the factory rear crossmember mount. **See Photos 32 & 33.**



40. Using a reciprocating saw, cut along the marks made on the front and rear of the factory rear crossmember mount. **See Photo 34.**

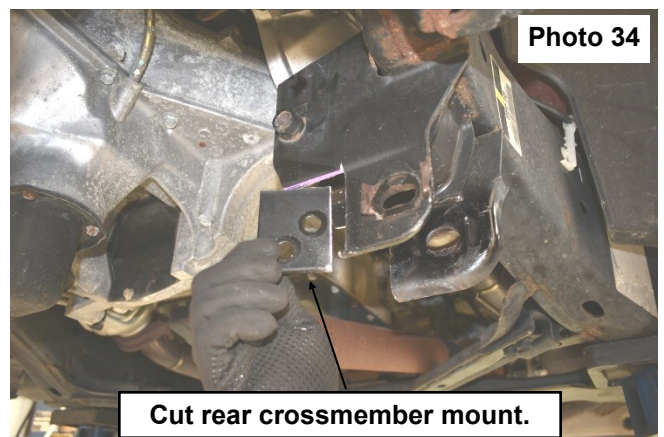

41. Smooth the cut edges and paint to prevent rust. **See Photo 35.**
42. Install the supplied front crossmember using the factory hardware. **Do not tighten at this time. See Photo 36.**

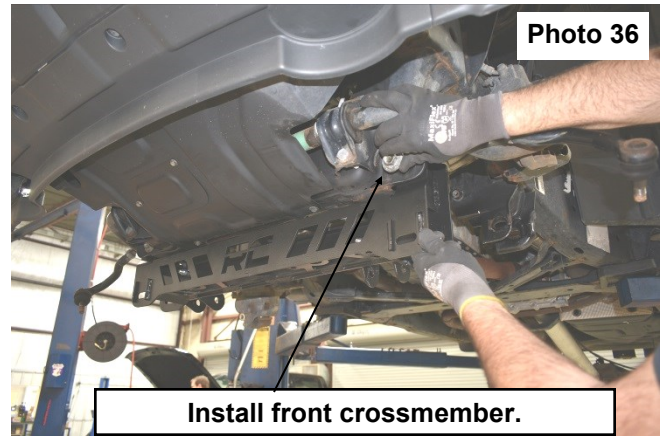
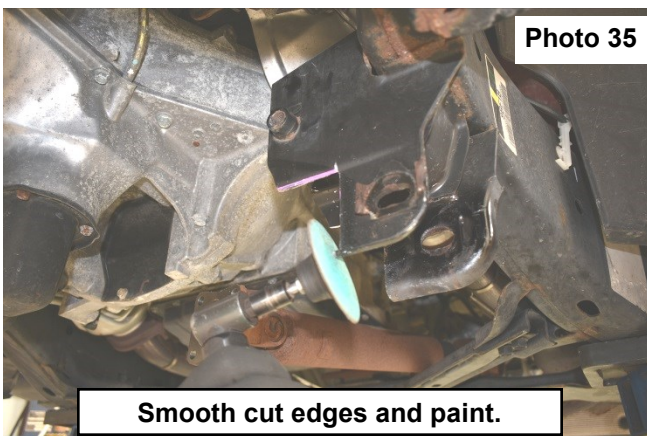

43. **2wd models skip, to step 45.** Attach the front dr diff mount to the factory mount using the supplied 9/16" x 4" bolt, washers, and nylock nut (1879BAG2). **Do not tighten at this time. See Photo 37.**
44. Install the diff in the front brackets using the factory hardware. **Do not tighten at this time. See Photo 38.**

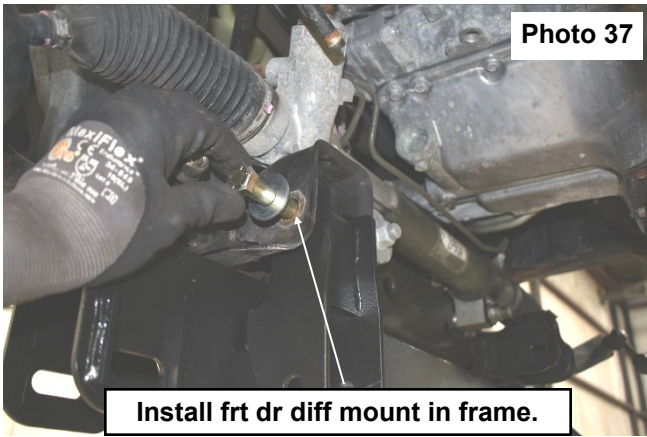

Install frt dr diff mount in frame.

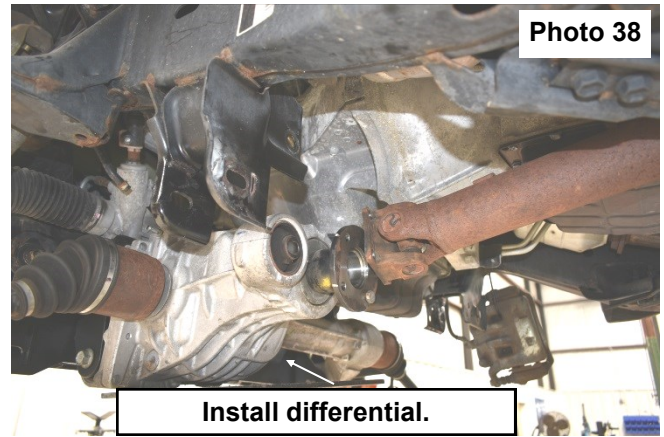

Install differential.

45. Install the supplied rear crossmember using the factory hardware. **Do not tighten at this time. See Photo 39.**
46. **2wd models, skip to step 52.** Attach the diff to the crossmember using the supplied 9/16" x 4" bolt, washers and nylock nut(1879BAG1). **Do not tighten at this time. See Photo 40.**

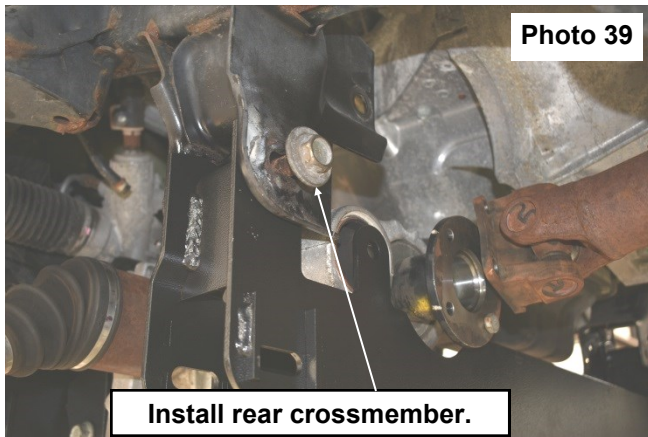

Install rear crossmember.

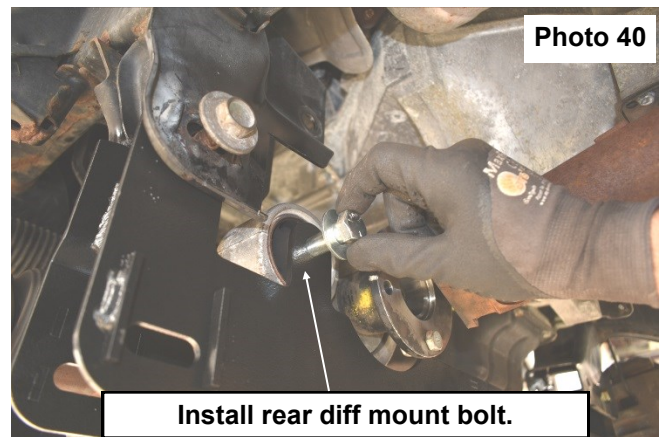

Install rear diff mount bolt.

47. Install the diff vent tube coupler and extension. **See Photo 41.**
48. Using a reciprocating saw, cut the driver transfer case crossmember brace at the crossmember. **See Photo 42.**
49. Using a 17mm socket and wrench, remove the driver transfer case crossmember brace. **See Photo 43.**
50. **Paint the cut edge to prevent rust.**

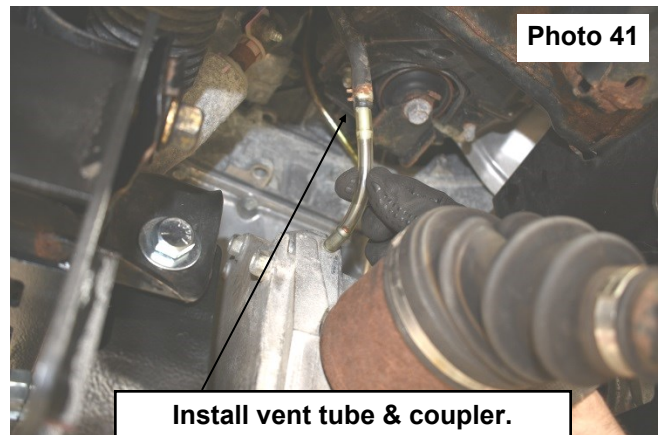

Install vent tube & coupler.

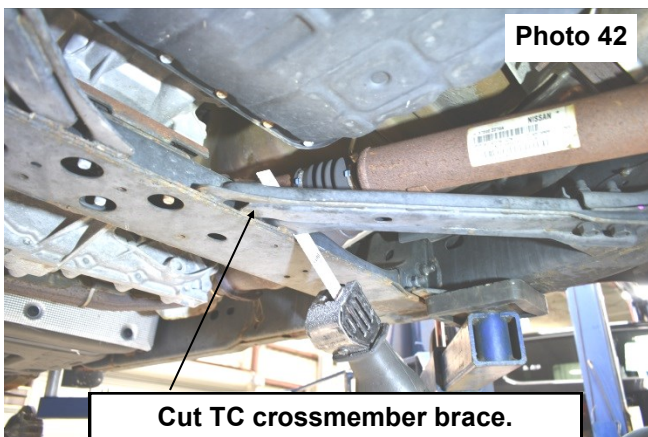

Cut TC crossmember brace.

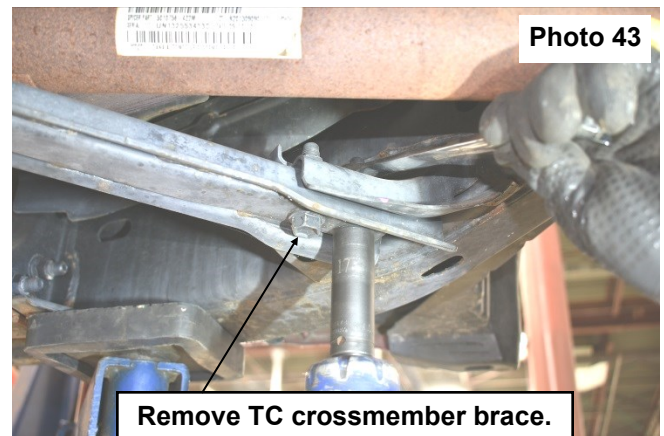

Remove TC crossmember brace.

51. Using 14mm wrenches and the factory hardware, attach the driveshaft to the differential flange. Torque to factory specs. Use a thread locker on the driveshaft bolts. **See Photo 44.**
52. Install the lower control arms using the supplied cam bolts, cam washers, flat washers (nut end) and 14mm nylock nuts (1879BAG1). **Do Not tighten at this time. See Photo 45.**

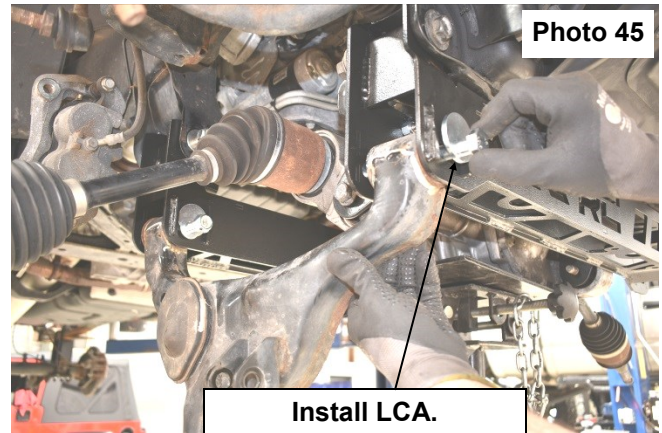
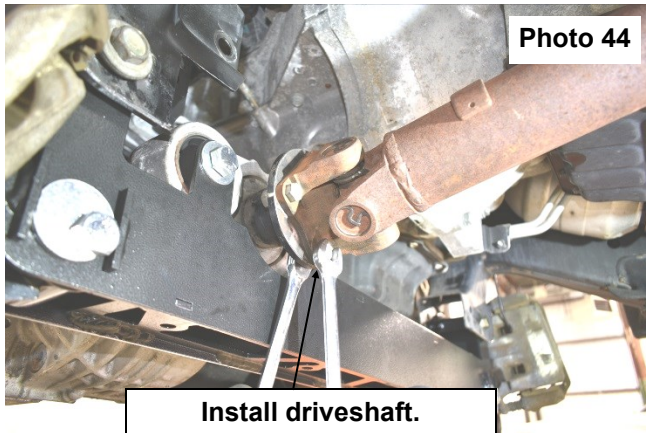

53. **2wd models, skip to step 54.** Tighten the differential mounts on the front crossmember using a 9/16" socket and wrench. Torque to 35ft/lbs.
54. Tighten the factory cross member bolts using a 19mm socket and 22mm wrench. Torque to factory specs.
55. **2wd models, skip to step 57.** Tighten the rear diff mounting bolt using a 13/16" socket and wrench. Torque to 130ft/lbs.
56. Tighten the front diff mounting bolts using a 19mm socket and wrench. Torque to factory specs.
57. Place the supplied studs (10MMSTUDBAG-1) into the supplied strut spacer. **See Photo 46.**
58. Use the supplied 1/2" nut and 10mm nut to pull the stud into the spacer. **Do not use an impact to install the studs into the strut spacer. See Photo 47.**

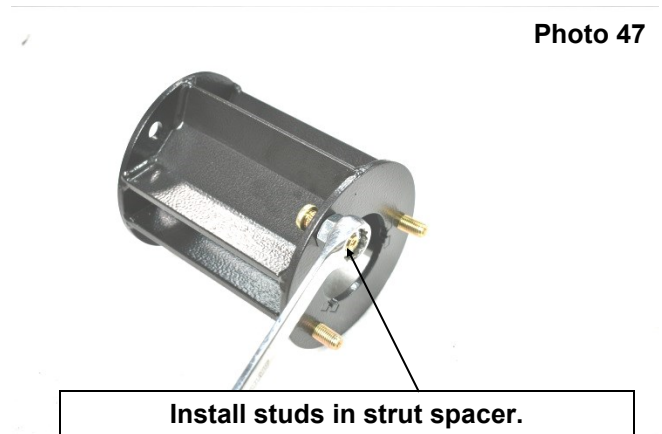
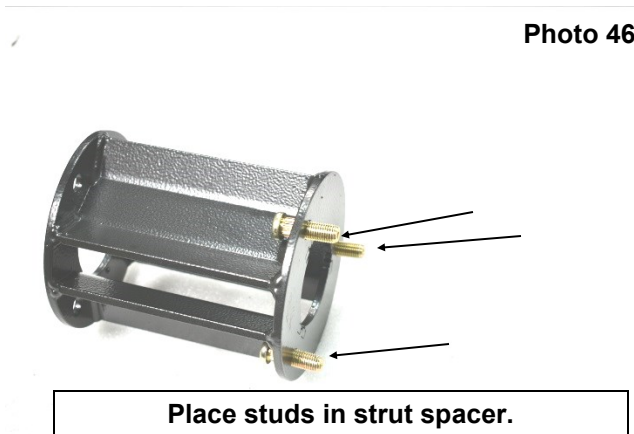

59. Attach the strut spacer to the top of the strut using the factory hardware. Tighten using a 14mm. **See Photo 48.**
60. Install the strut using the factory hardware on the bottom mount and the supplied hardware (10MMSTUDBAG-1) for the top. Tighten the upper using a 17mm and the lower using a 19mm socket and 22mm wrench. Torque to factory specs. **See Photo 49.**

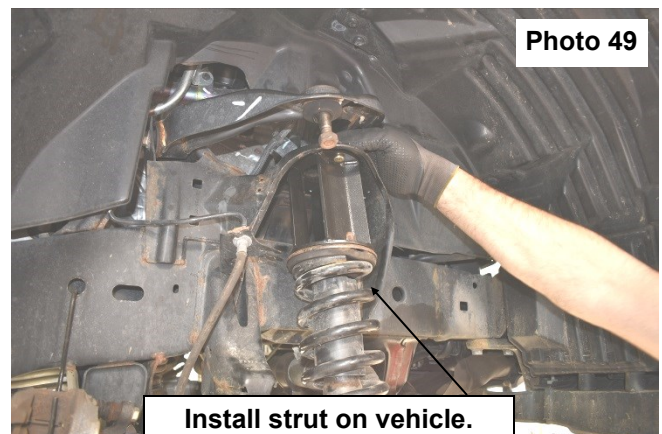
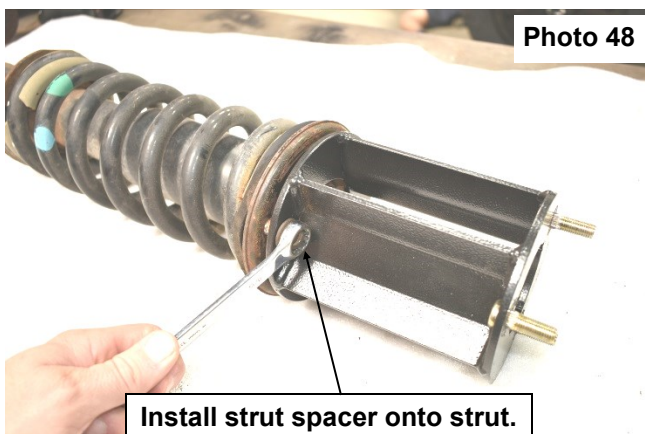

61. Using a 10mm socket, remove the bolts holding the lower valance. Retain hardware for reuse. **See Photo 50.**

62. Remove the lower valance. **See Photo 51.**

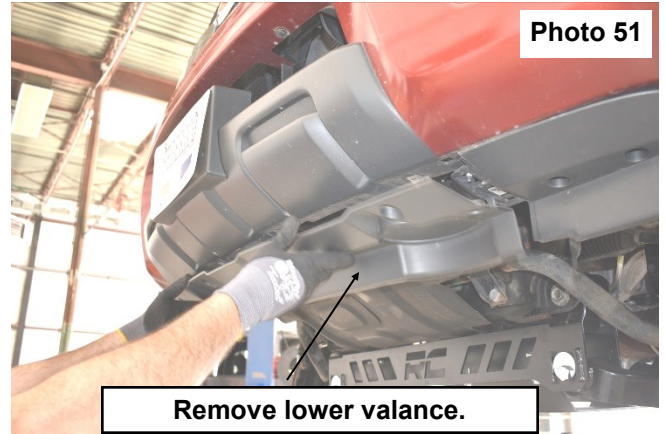
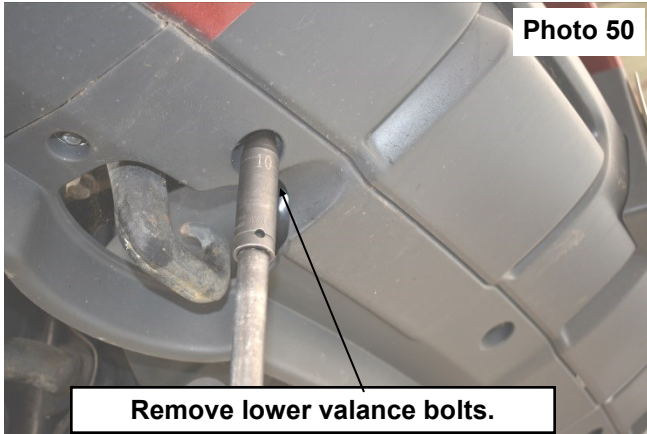

63. Using a Phillips head screwdriver, remove the front screws going into the factory skid. Retain for reuse. **See Photo 52.**

64. Using a Phillips head screwdriver, remove the screws holding the skid to the factory crossmember. Retain for reuse. **See Photo 53.**

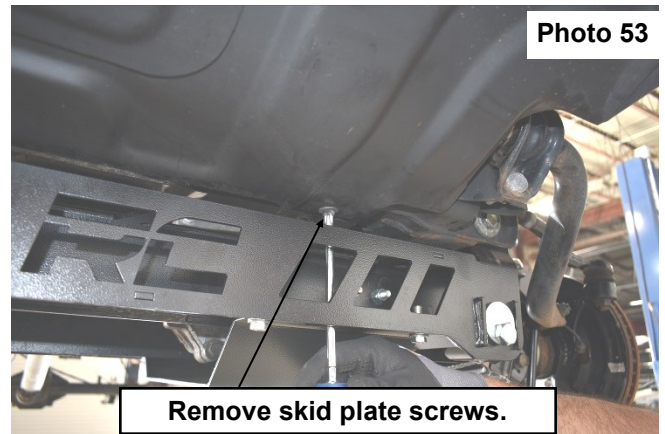

65. Using a 10mm socket, remove the front skid plate bolts. Retain the hardware for reuse. **See Photo 54.**

66. Remove the factory skid plate. **See Photo 55.**

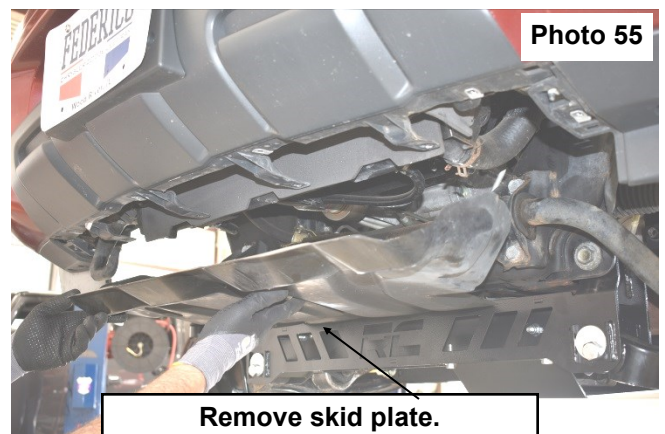
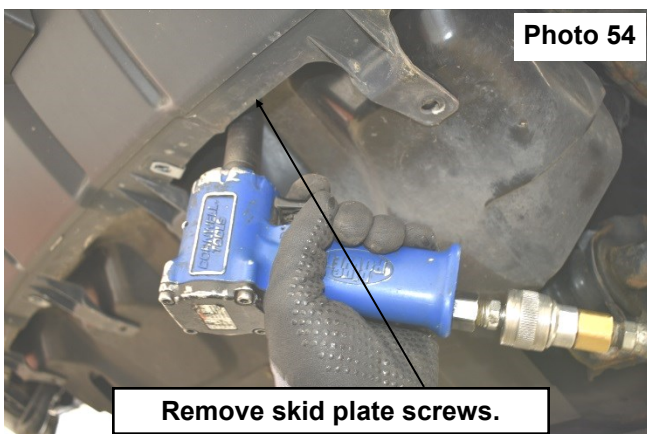

- 67. Using a 15mm socket, remove the sway bar from the frame. Retain hardware for reuse.
- 68. Install the supplied sway bar relocation bracket using the factory hardware. **See Photo 56.**
- 69. Tighten the sway bar relocation brackets using a 15mm socket. Torque to factory specs. **See Photo 57.**

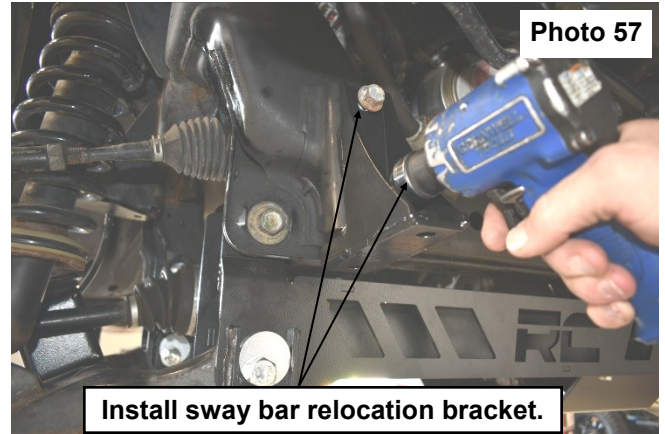
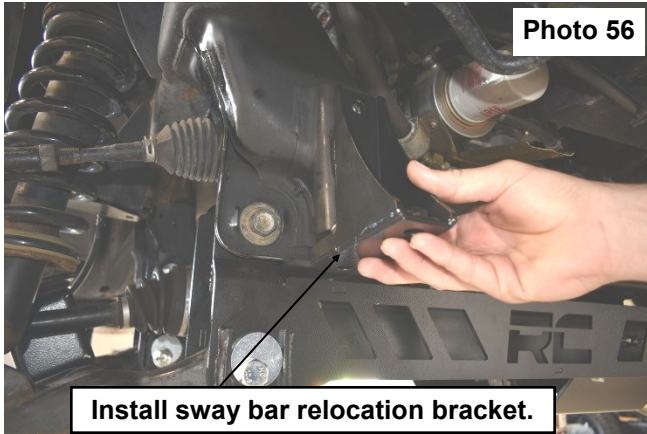

- 70. Install the sway bar on the relocation brackets using the supplied 7/16" x 1.5" bolts, lock washer, and flat washers (1879BAG2). Torque to 60ft/lbs using a 5/8" socket. **See Photo 58.**
- 71. Install the factory skid using the factory hardware.
- 72. Install the lower valance using the factory hardware.
- 73. Install the sway bar link into the lower control arm using a 19mm socket and 22mm wrench. **See Photo 59.**

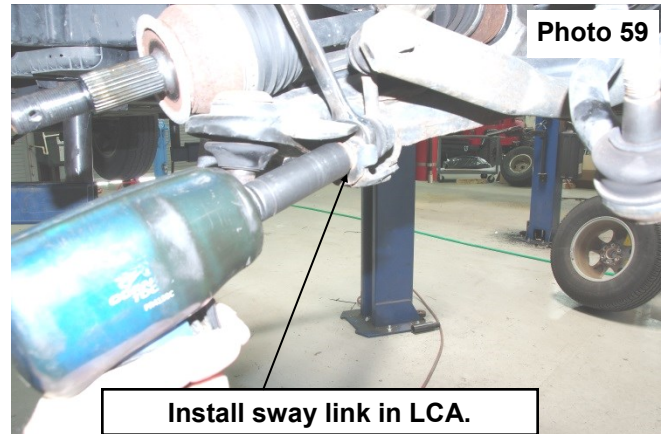
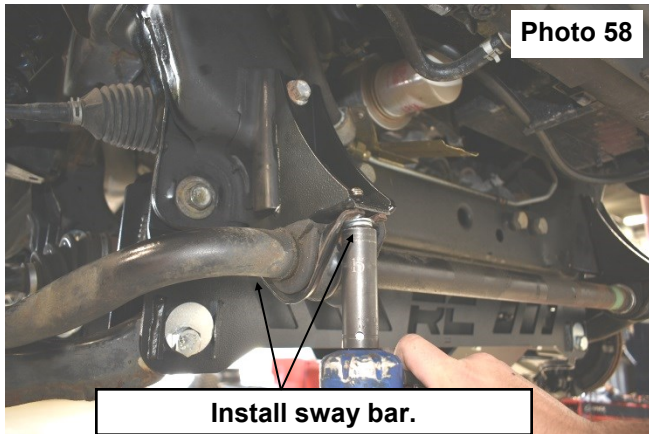

- 74. Using a 17mm socket, remove the 4 bolts securing the hub to the knuckle. Retain for reuse. **See Photo 60.**
- 75. Remove the factory knuckle and install the supplied lift knuckle. **See Photo 61.**

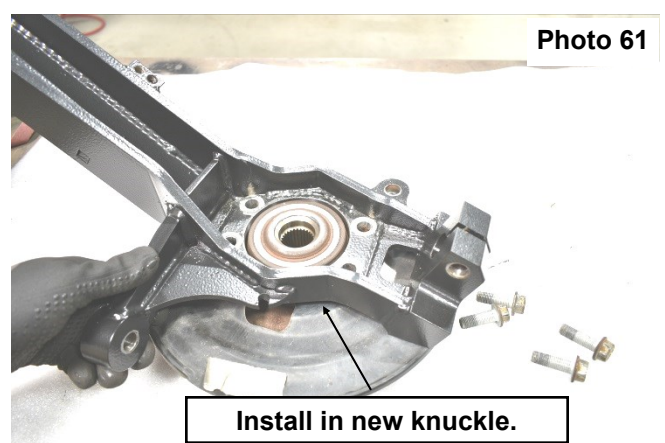
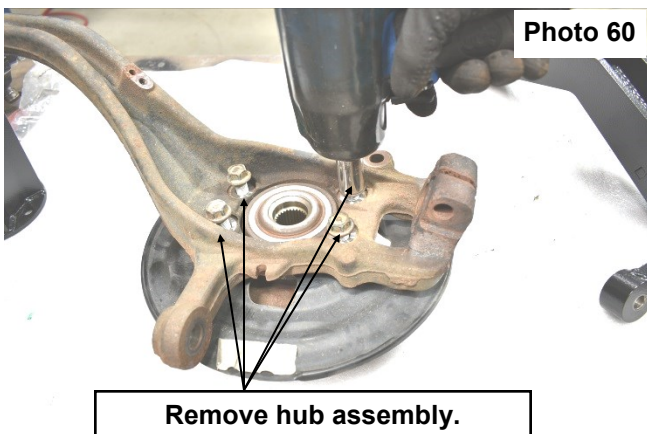

76. Using a 17mm socket, torque the hub bolts to the factory spec. **See Photo 62.**
77. Install the knuckle onto the lower and upper ball joints using the factory hardware, making sure to align the splines on the CV axle in the hub. **See Photo 63.**

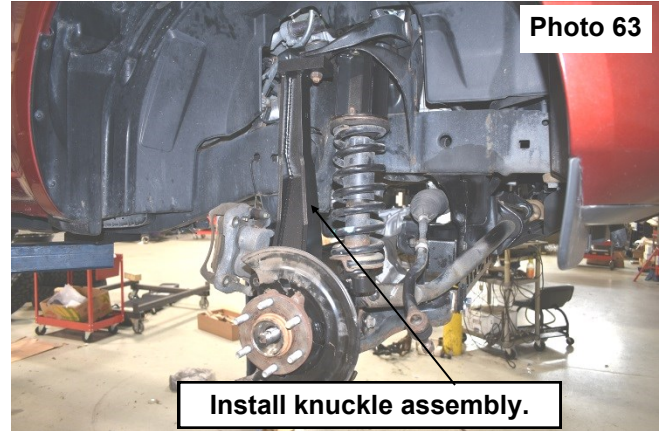
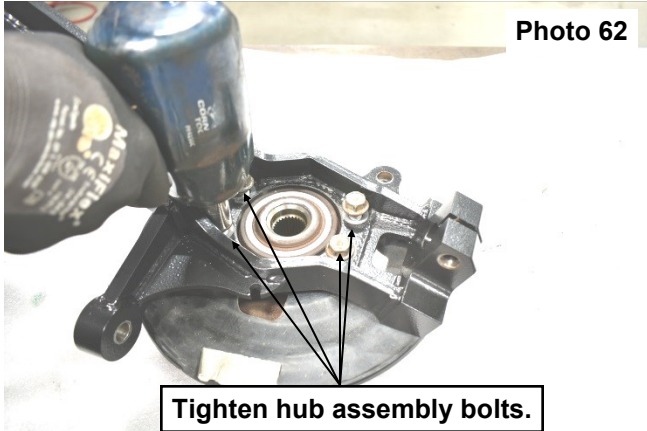

78. Tighten the upper ball joint nut using a 22mm wrench. Install new cotter pin. **See Photo 64.**
79. Tighten the lower ball joint pinch bolt using a 17mm wrench and 21mm socket. Torque to factory spec. **See Photo 65.**

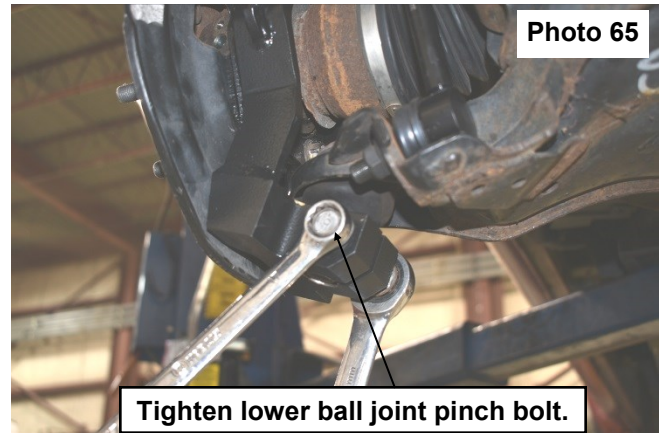
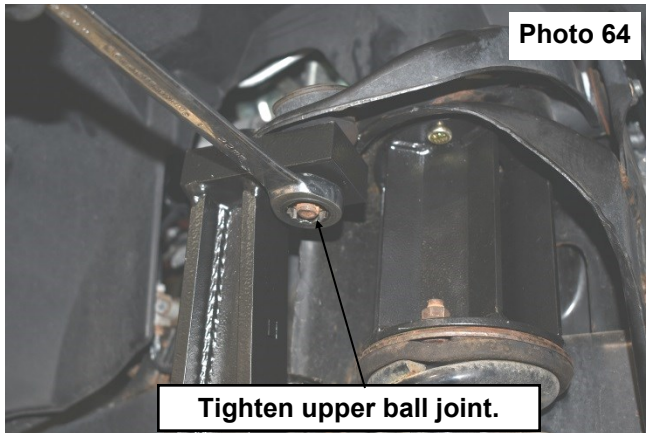

80. **2wd models, skip to step 81.** Install the axle nut using a 32mm socket. Torque to factory spec. Install new cotter pin. **See Photo 66.**
81. Install the ABS sensor in the hub using a 5mm Allen wrench. **See Photo 67.**

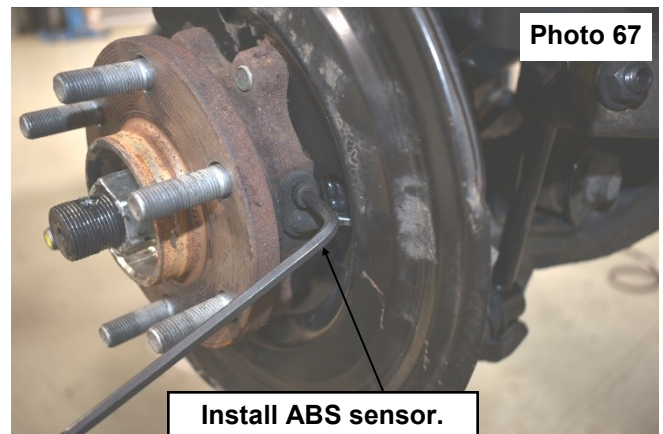
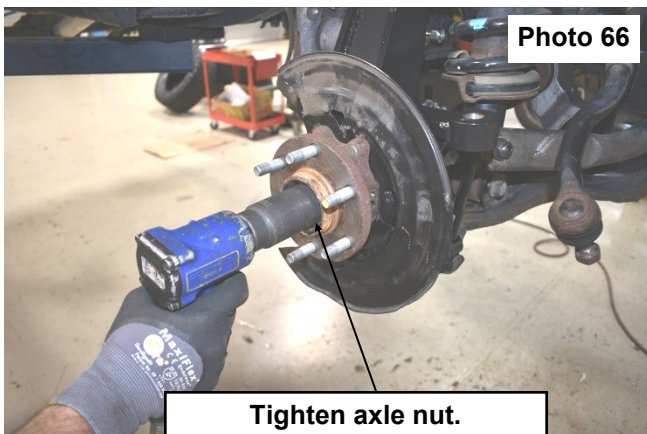

82. Mark the ABS wire bracket as shown in **Photo 68**.

83. Cut the brackets as shown in **Photo 69**.



Photo 68

Mark ABS brackets.

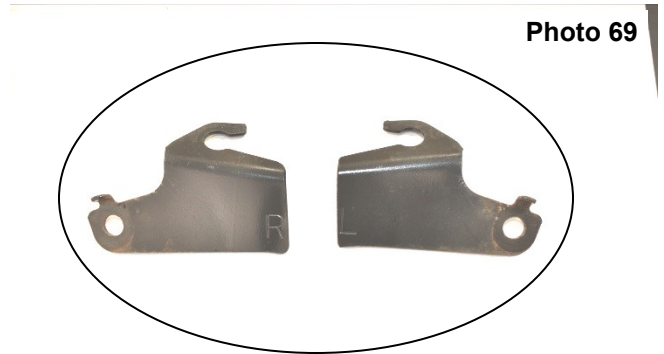

Photo 69

Cut ABS brackets.

84. Install the ABS wire bracket on the new knuckle using the factory hardware and a 10mm socket. **See Photo 70**.

85. Install the brake rotor. **See Photo 71**.

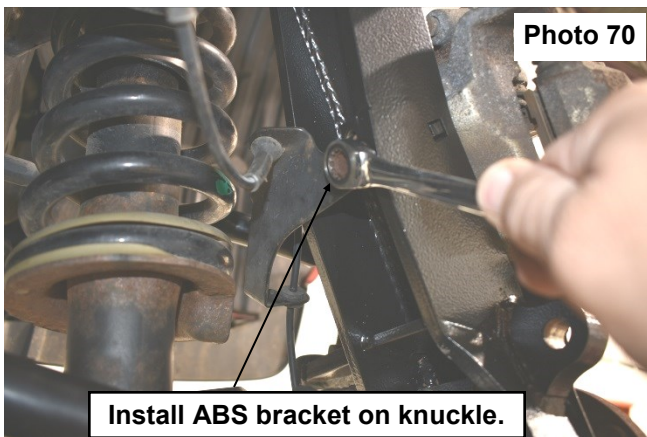

Photo 70

Install ABS bracket on knuckle.

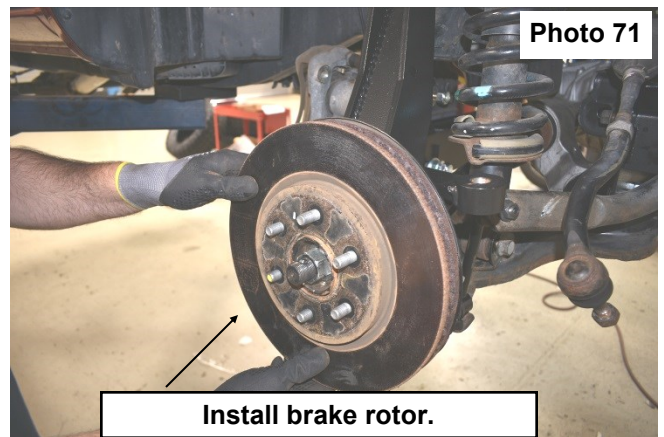

Photo 71

Install brake rotor.

86. On the factory bump stop bracket, measure from the bottom 1.625" and mark. **See Photo 72**.

87. Measure 2" from the inside of the truck and mark. **See Photo 73**.

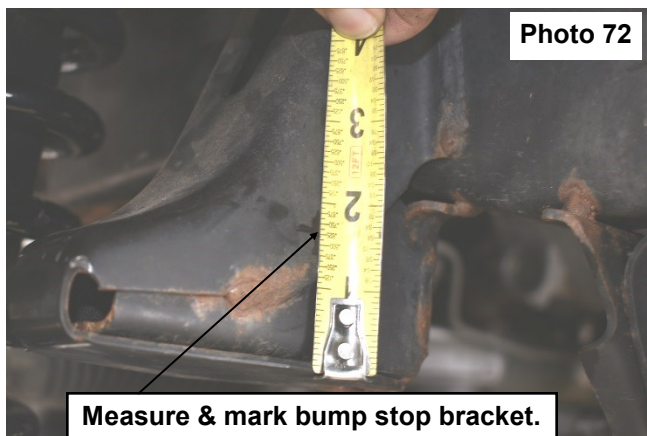

Photo 72

Measure & mark bump stop bracket.

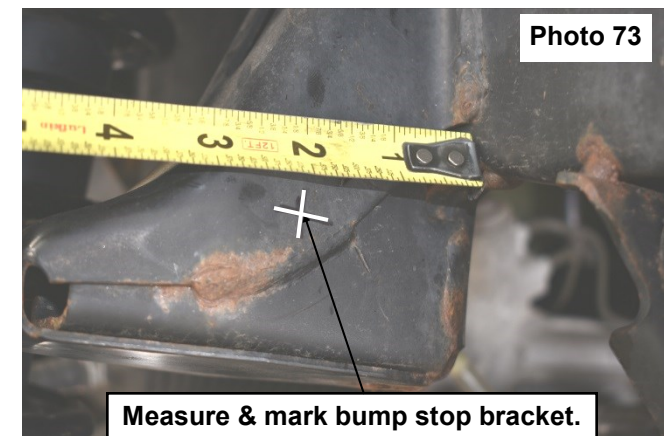
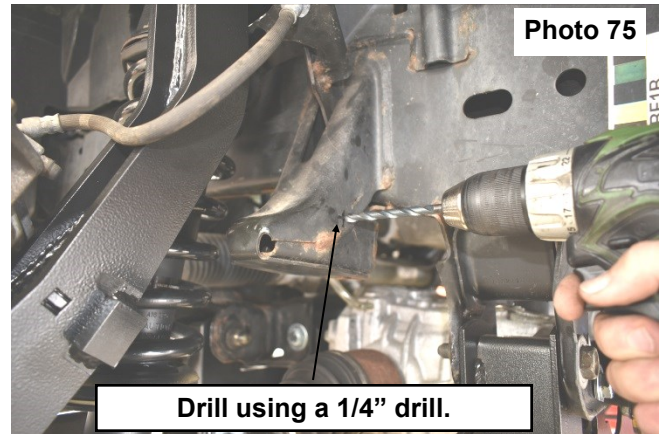
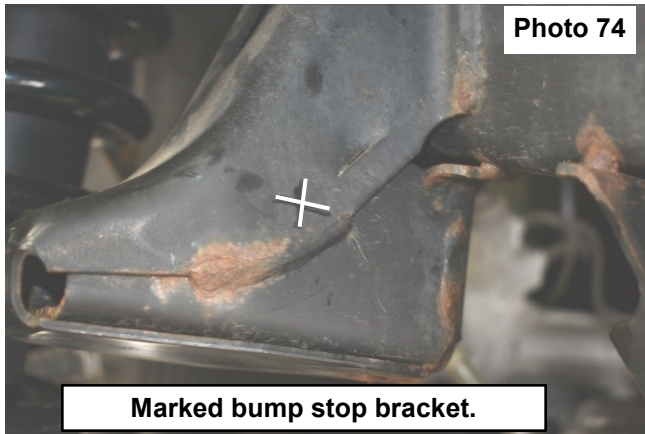

Photo 73

Measure & mark bump stop bracket.

88. Mark on the factory bump stop bracket. **See Photo 74.**
89. Center punch and drill using a 1/4" drill. **See Photo 75.**



90. Install the supplied brake line bracket (1879BAG4) using the supplied 5/16" self-tapping bolt (1879BAG2) and a 1/2" socket. **See Photos 76 & 77.**

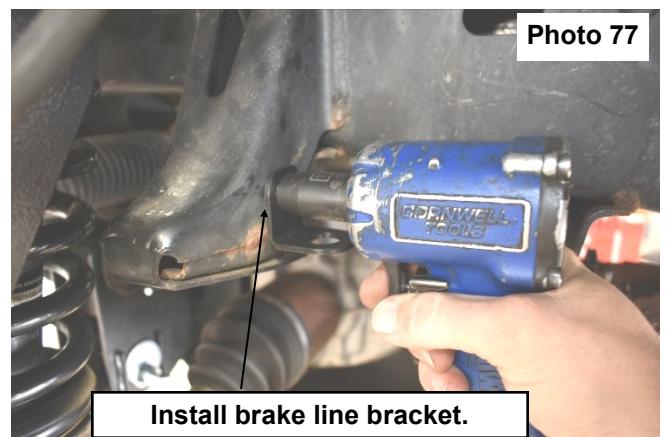
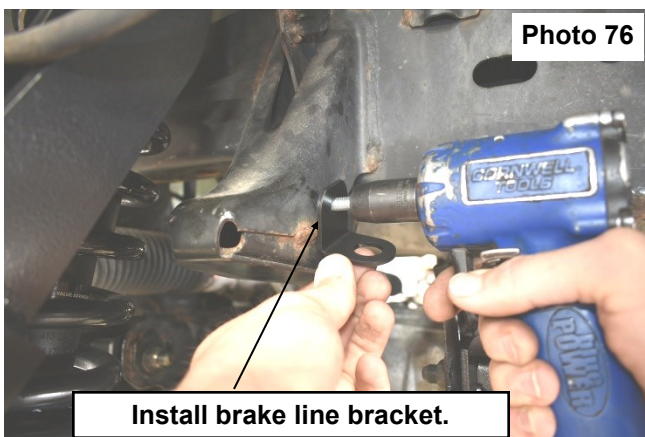

91. Using a 10mm wrench remove the factory hard brake line from the flexible line and the frame. **See Photos 78 & 79.**

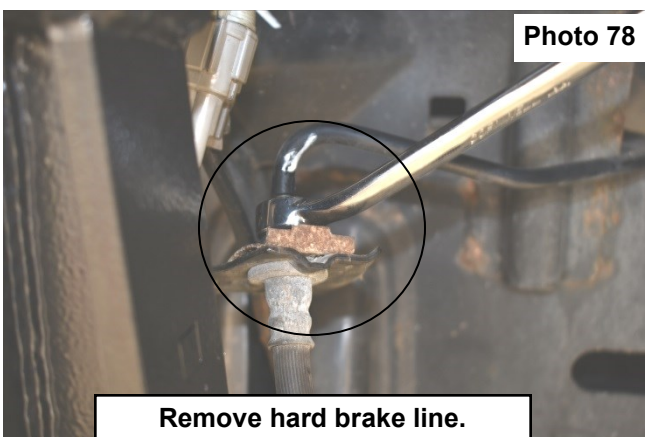

92. Using a pair of pliers, remove the brake line clip. **See Photos 80 & 81.**

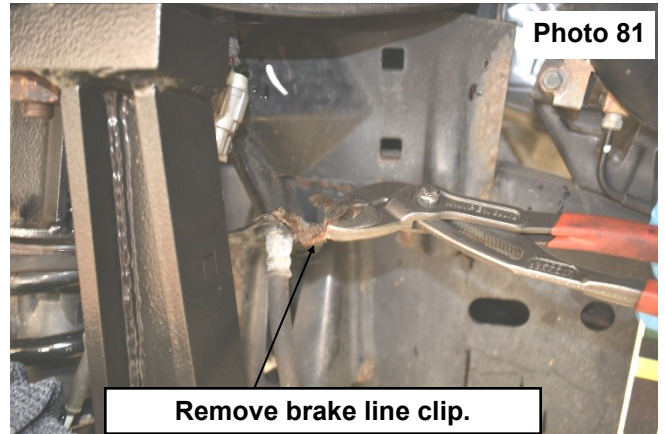
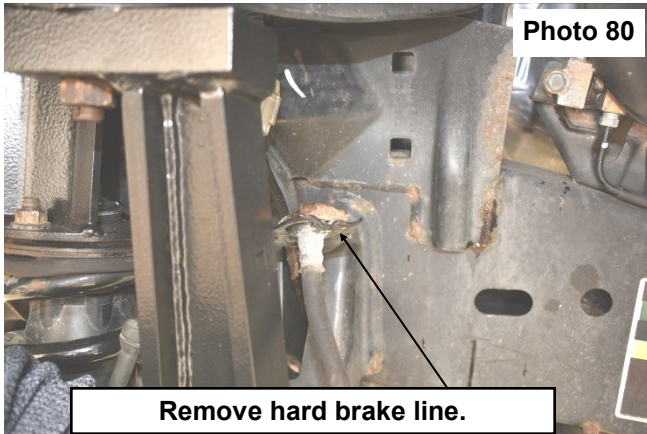

93. Remove the brake line from the bracket. **See Photo 82.**

94. Once the brake line is free from the bracket, install the brake caliper using the factory hardware. Torque to factory specs using a 19mm socket. **See Photo 83.**

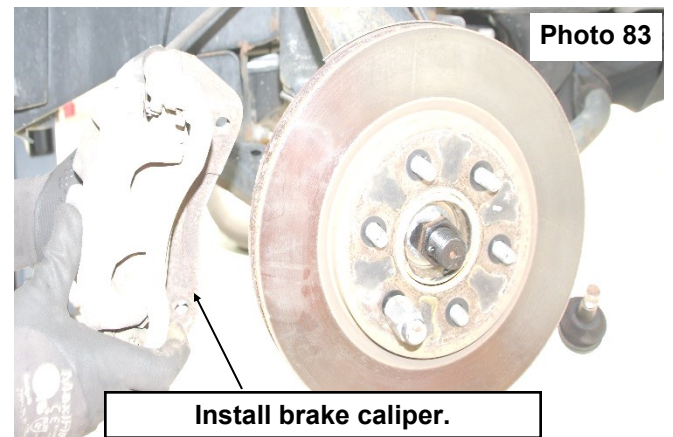
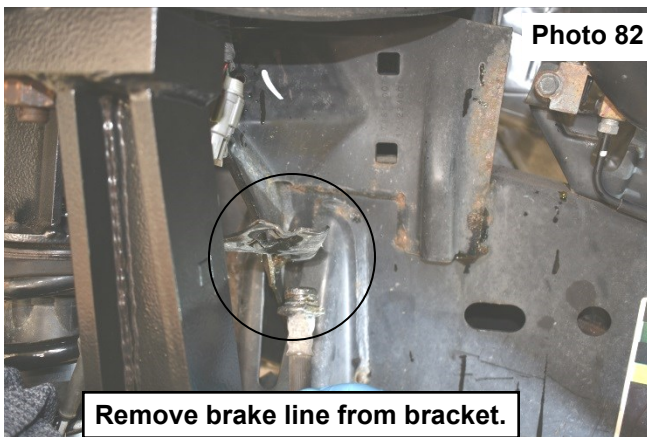

95. Install the supplied longer hard brake line in the upper frame mount. **See Photo 84.**

96. Install the flexible brake line into the new lower bracket using the factory clip. Install the hard line into the stock flexible line. **See Photo 85.**

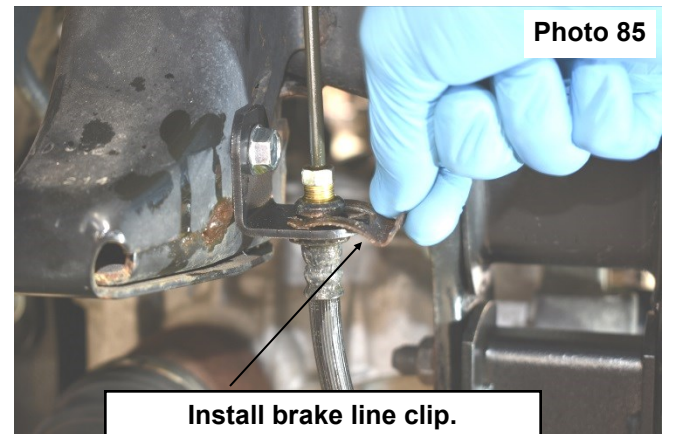
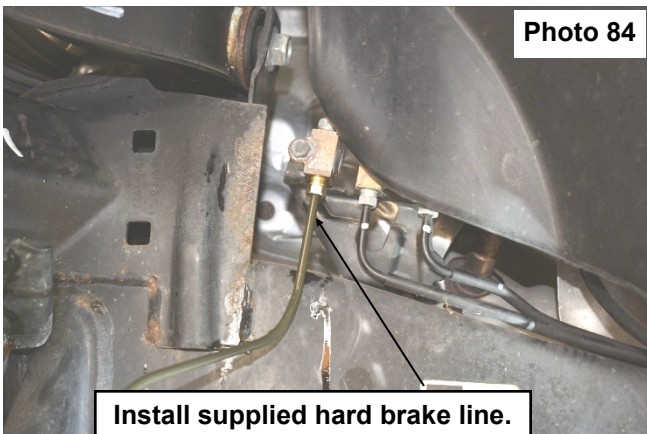

97. Tighten the brake line using a 10mm wrench. **See Photo 86.**

98. Using a reciprocating saw or cutoff wheel, cut the factory brake line mount off of the bump stop bracket. **See Photo 87.**

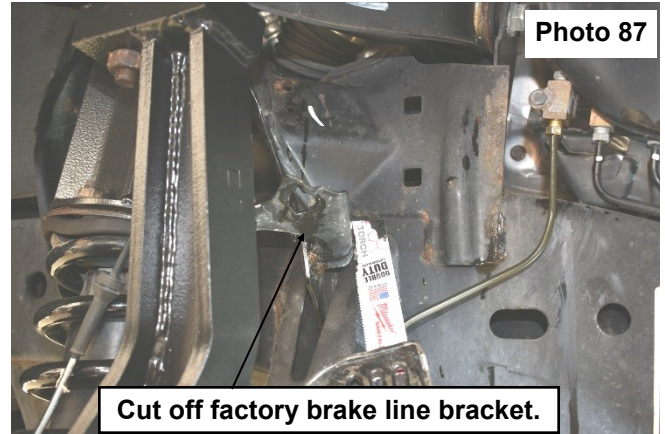
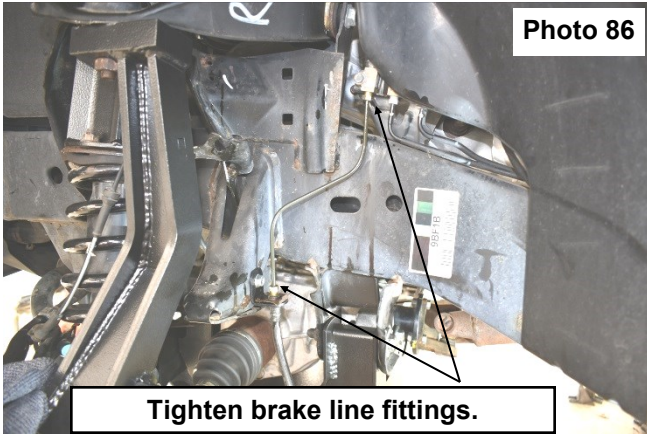

99. Remove any sharp edges and paint the bare area to prevent rust. **See Photo 88.**

100. Install the supplied flag nut (1879BAG4) into the factory bump stop bracket. **See Photo 89.**

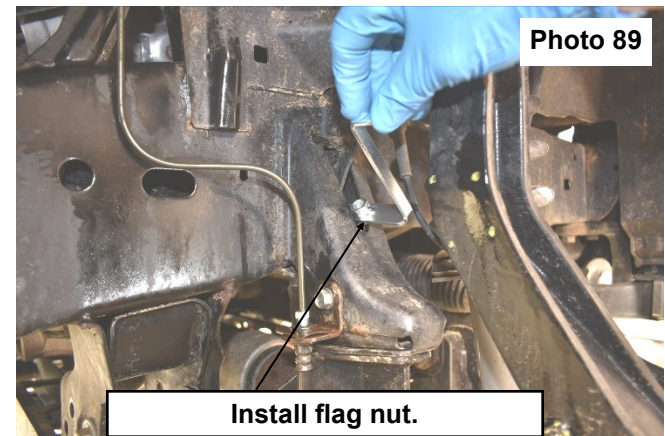
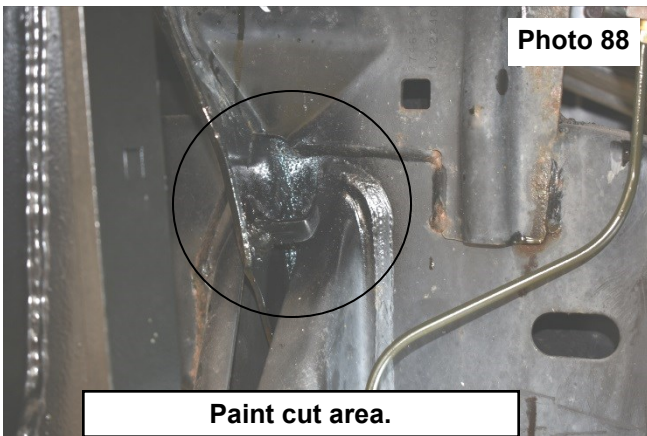

101. Install the supplied bump stop bracket, using a supplied 3/8" x 1.25" bolt, flat washer and lock washer (1879BAG2), onto the bottom of the factory bump stop bracket. **Do not tighten.** **See Photo 90.**

102. Attach the supplied bump stop bracket to the rear crossmember using the supplied 3/8" x 1.5" bolts, flat washers, and flange lock nuts (1879BAG2). **See Photo 91.**

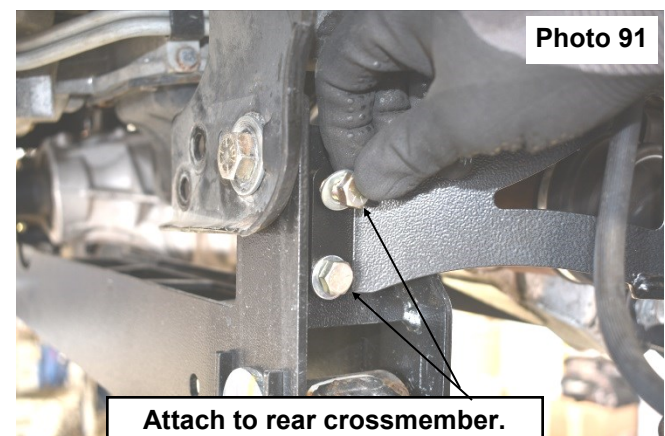
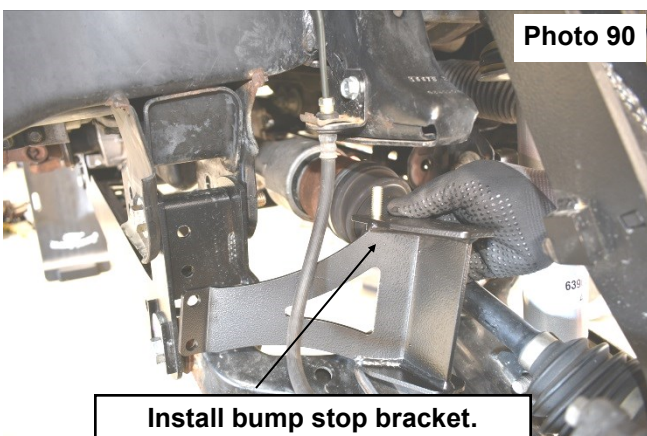

103. Tighten the bump stop bracket bolts using a 9/16" socket and wrench. Torque to 35ft/lbs. **See Photos 92 & 93.**

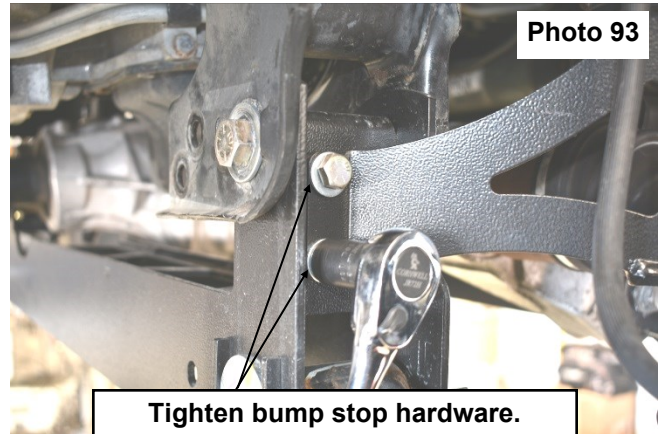
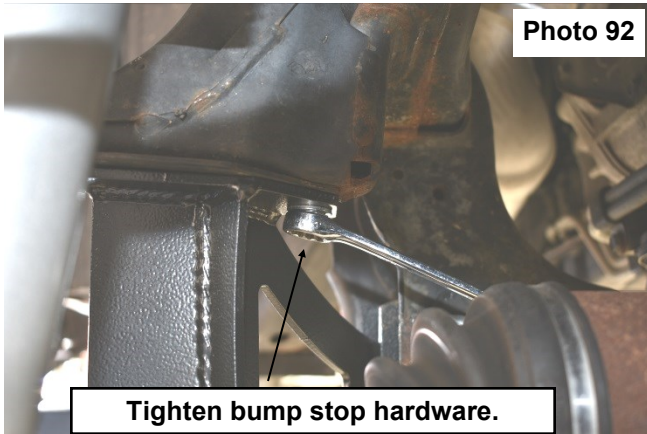

104. Remove the tie rod ends and swap driver side to passenger side and vice versa. Install using the factory hardware. Tighten using a 22mm wrench. Install new cotter pins. **See Photo 94.**

105. Install the differential skid plate using the supplied 3/8 x 1" bolts, flat washers, and lock washers. Torque to 30ft/lbs using a 9/16" socket. **See Photo 95.**

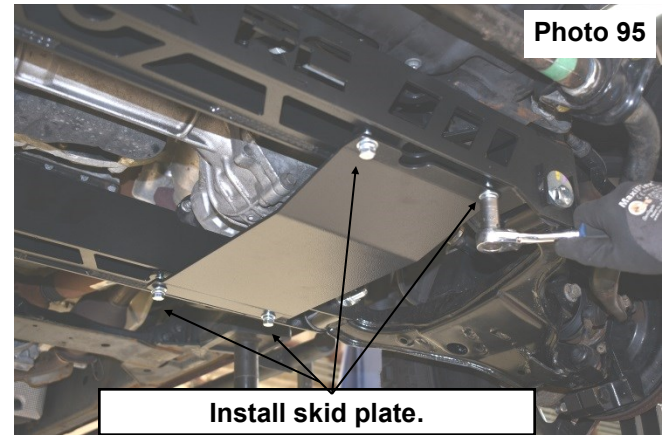

106. Plug the ABS wire up.

107. Install wheel and tires and lower the vehicle to the ground.

108. Center the lower control arm adjusting bolts and tighten using a 22mm wrench and socket.

109. Bleed the front brakes to ensure there is no air in the brake system.

REAR INSTALLATION INSTRUCTIONS

1. Chock the front tires.
2. Position a floor jack under the rear differential and jack up the vehicle.
3. Place jack stands under the frame rails just forward of the front leaf spring hangers and lower the frame on the jack stands.
4. Reposition the floor jack under the center of the differential and apply slight pressure for support, but do not raise the frame off the jack stands.
5. Remove the wheels and tires using a 21mm socket.
6. On the passenger side, unclip the brake line from the axle. **See Photo 1.**
7. Remove the brake line from the axle bracket. **See Photo 2.**

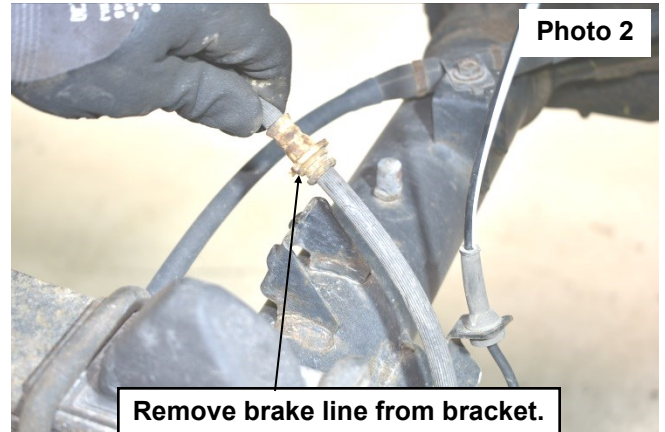
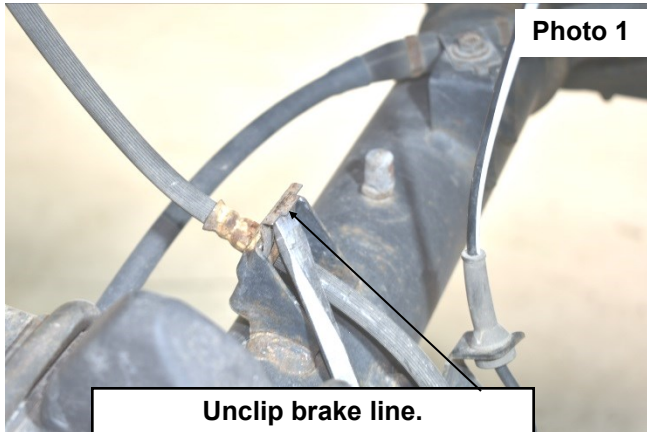

8. Using a 10mm, remove ABS bracket from the axle. Remove the ABS wire from the bracket and discard the bracket. **See Photo 3.**
9. On the driver side, unclip and remove the brake line from the axle bracket. **See Photo 4.**

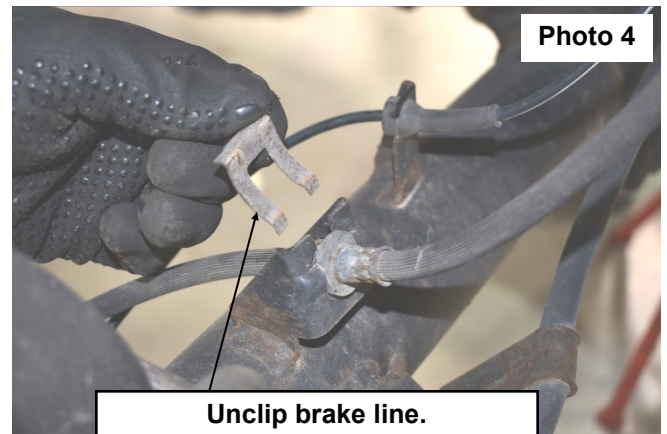
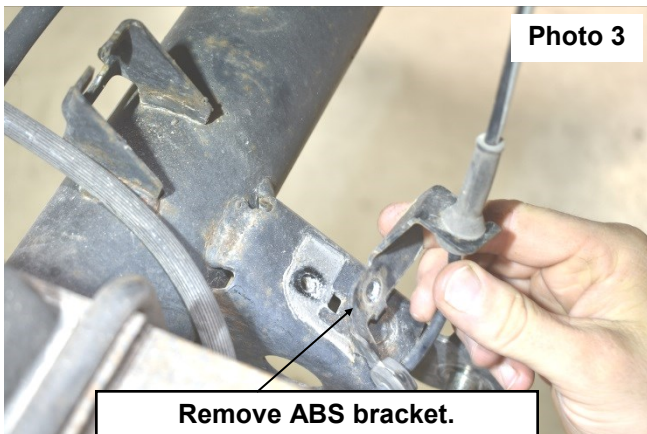

10. Remove the ABS wire from the axle bracket. **See Photo 5.**
11. Using 19mm wrenches, remove the lower shock mounting bolt and retain for reuse. **See Photo 6.**

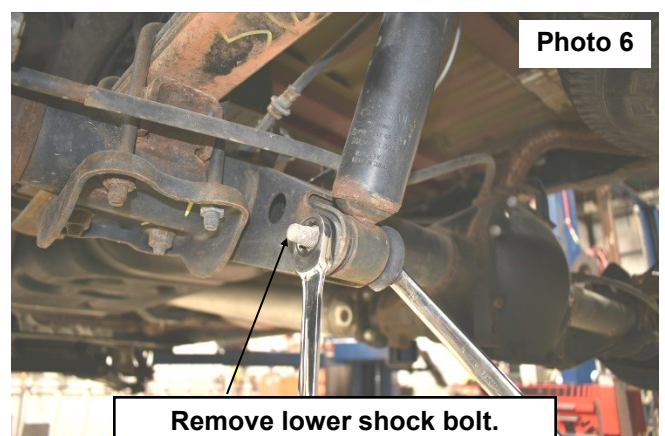
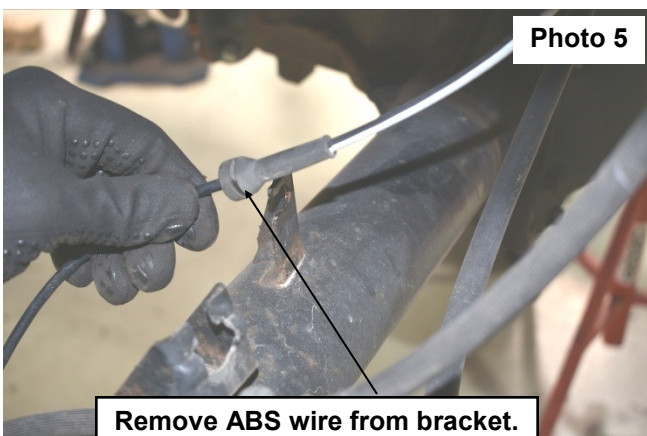

12. Using a 17mm wrench, remove the shock nut and retain for reuse. **See Photo 7.**

13. Using an 18mm socket remove the ubolt nuts. **See Photo 8.**

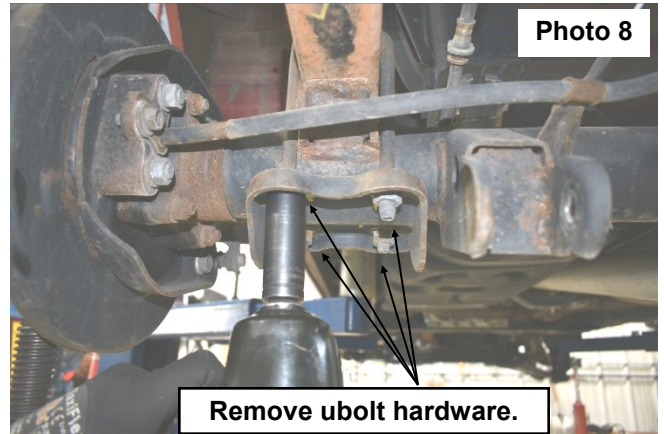
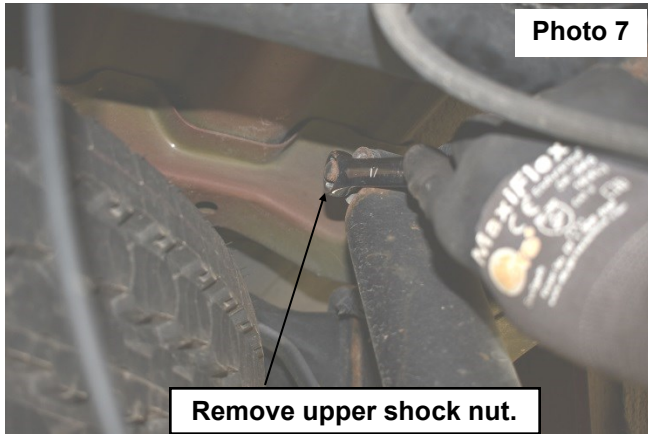

14. Place supplied lift block between the leaf spring and axle pad. **Thicker end of the block goes to the rear of the truck. See Photo 9.**

15. Install the supplied ubolts. **See Photo 10.**

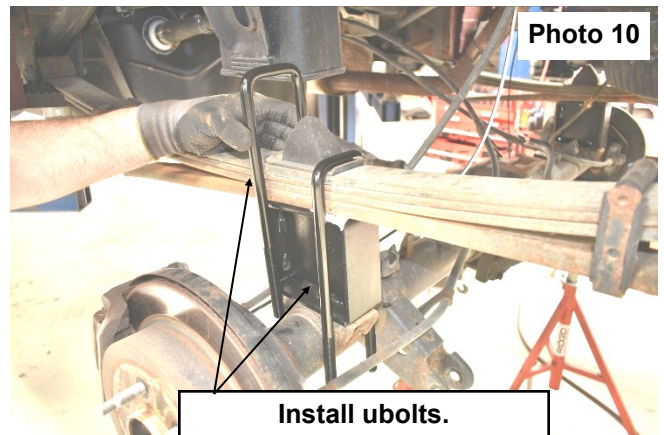
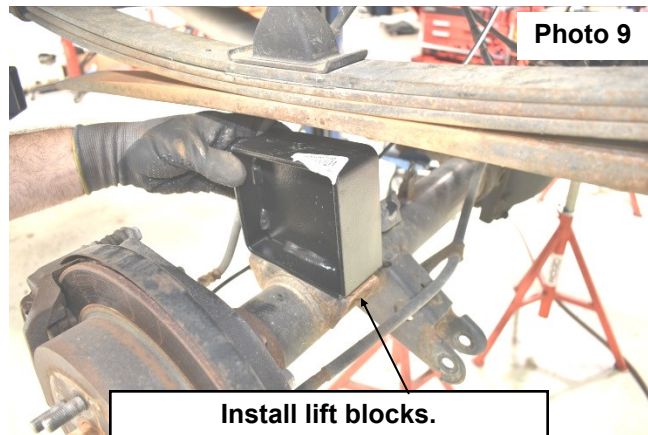

16. Using a 19/32" drill, drill the ubolt plates. **See Photo 11.**

17. Install the u-bolt plates and hardware (9/16BAG). Torque to 90ft/lbs using a 7/8" socket. **See Photo 12.**

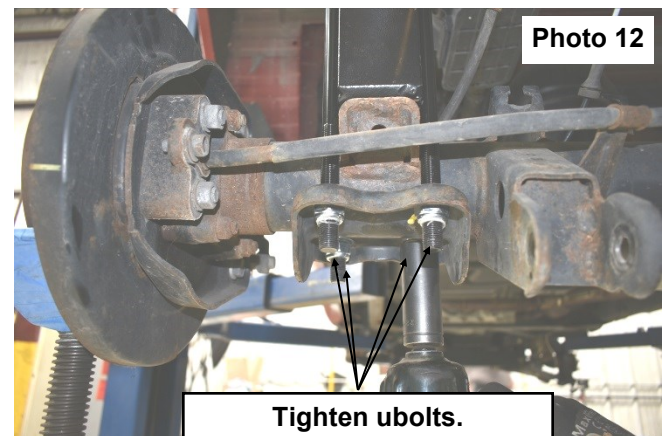
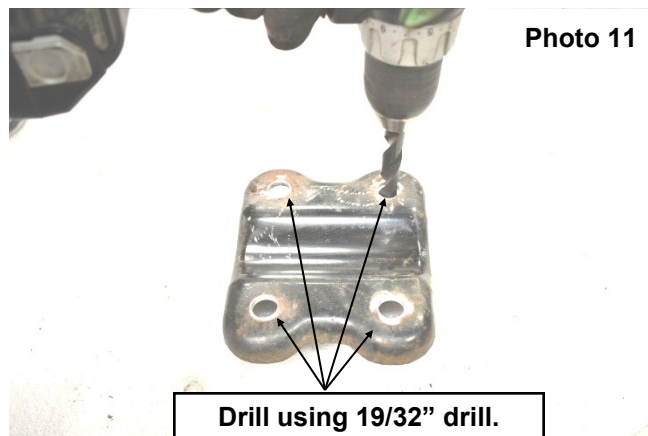

18. Install the supplied shock with the factory hardware and tighten using 17mm and 19mm wrench.
19. Using a 10mm socket, remove the emergency brake cable from the center bracket. Attach the supplied bracket (1879BAG4) using the supplied 5/16" x .75" bolt, washer, and flange lock nut (1879BAG4). Tighten using a 1/2" socket and wrench. Torque to 15ft/lbs. **See Photo 13.**
20. Using a 10mm socket, remove the emergency brake cable from the passenger bracket. Attach the supplied bracket (1879BAG4) using the supplied 5/16" x .75" bolt, washer, and flange lock nut (1879BAG4). Tighten using a 1/2" socket and wrench. Torque to 15ft/lbs. **See Photo 14.**

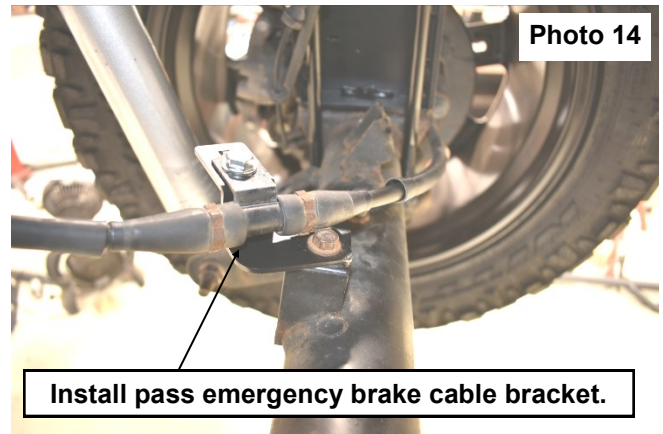
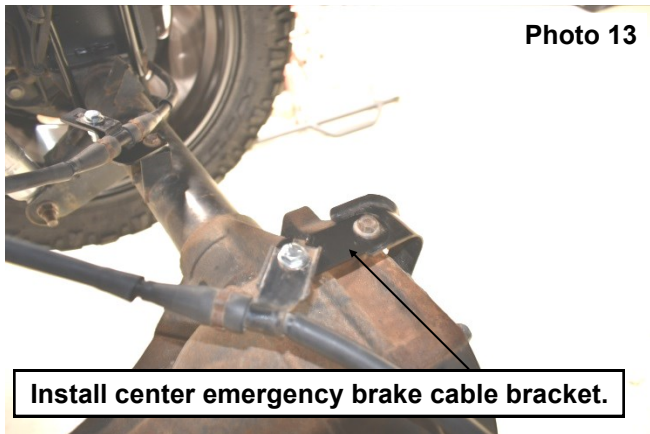

21. Using a cable tie, tie the dr brake line to the u-bolt. **See Photo 15.**
22. Remove the sway bar link using an 18mm wrench. **See Photo 16.**

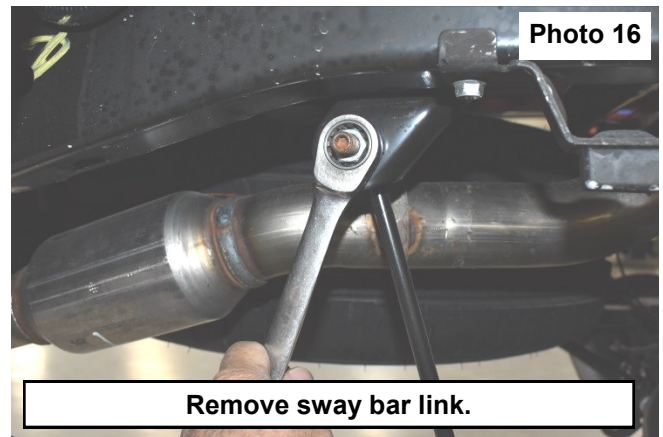
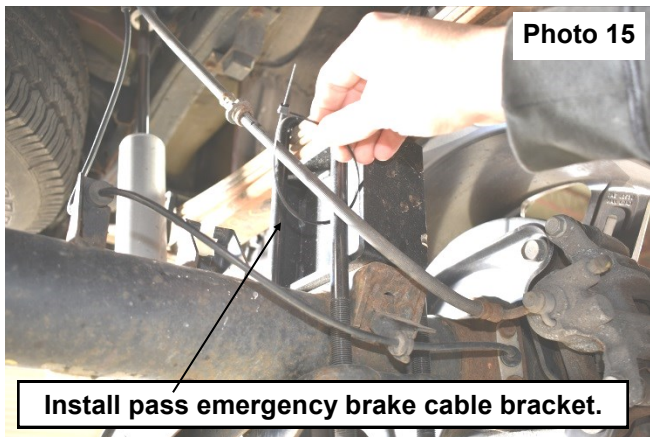

23. Install the supplied bushing sleeves in the new sway bar link. **See Photo 17.**
24. Install the new sway bar link in the stock location with the hardware in 1875bag5 using an 18mm and 19mm socket/wrenches. **See Photo 18.**



25. Install wheels and tires and lower the vehicle to the ground.
26. Tighten lug nuts to factory specifications.

POST INSTALLATION INSTRUCTIONS

1. Check all fasteners for proper torque. Check to ensure for adequate clearance between all rotating, mobile, fixed, and heated members. Verify clearance between exhaust and brake lines, fuel lines, fuel tank, floor boards and wiring harness. Check steering gear for clearance. Test and inspect brake system.
2. On some vehicles the front lower skirting will need to be trimmed if using certain wheel /tire combinations and with heavy offset wheels. Trim only as needed.
3. Activate four wheel drive system and check front hubs for engagement.
4. Have a qualified alignment center align the vehicle immediately. Realign to factory specifications. Have headlights adjusted to proper settings.
6. Perform head light check and adjustment to proper settings.
7. Check and retighten wheels at 50 miles and again at 500 miles.
8. Recheck lifted height and adjust torsion bar as necessary.
9. All kit components must be retightened at 500 miles and then every three thousand miles after installation. Periodically check all hardware for tightness.
10. Install "Warning to Driver" decal on sun visor.

Alignment Specs

Front			
Total Toe	+0.08°	+0.12°	+0.15°
Front Camber	-0.25°	+0.50°	+1.25°
Caster	+2.25°	+3.00°	+3.75°
King-Pin	_____	_____	_____
Incl. Angle	_____	_____	_____
Rear			
Total Toe	°	°	°
Rear Camber	°	°	°
Thrust Angle	-.025°	+0.00°	+0.25°



Thank you for choosing Rough Country for all of your suspension needs.

By purchasing any item sold by Rough Country, LLC, the buyer expressly warrants that he/she is in compliance with all applicable , State, and Local laws and regulations regarding the purchase, ownership, and use of the item. It shall be the buyers responsibility to comply with all Federal, State and Local laws governing the sales of any items listed, illustrated or sold. The buyer expressly agrees to indemnify and hold harmless Rough Country, LLC for all claims resulting directly or indirectly from the purchase, ownership, or use of the items.

