

CAN-AM 2012-21 Renegade Winch Plate

Thank you for choosing Rough Country for all your vehicle needs.

Please read instructions before beginning installation. Check the kit hardware against the kit contents shown below. Be sure you have all needed parts and know where they go.

If question exist, please call us @1-800-222-7023. We will be happy to answer any questions concerning this product. Check all fasteners for proper torque. Check to ensure for adequate clearance between all components. Periodically check all hardware for tightness.

KIT CONTENTS:

- Bumper Mount Plate x1
- Winch Bumper Face x1

TOOLS NEEDED:

- 10mm Socket/Wrench
- 13mm Socket/Wrench
- T30 Torx Bit
- T40 Torx Bit

HARDWARE INCLUDED:

- 10mm x 25mm Bolts x2
- 10mm Flat Washers x2
- 10mm Lock Nuts x2



Torque Specs:

Size	Grade 5	Grade 8	Size	Class 8.8	Class 10.9
5/16"	15 ft/lbs	20ft/lbs	6MM	5ft/lbs	9ft/lbs
3/8"	30 ft/lbs	35ft/lbs	8MM	18ft/lbs	23ft/lbs
7/16"	45 ft/lbs	60ft/lbs	10MM	32ft/lbs	45ft/lbs
1/2"	65 ft/lbs	90ft/lbs	12MM	55ft/lbs	75ft/lbs
9/16"	95 ft/lbs	130ft/lbs	14MM	85ft/lbs	120ft/lbs
5/8"	135ft/lbs	175ft/lbs	16MM	130ft/lbs	165ft/lbs
3/4"	185ft/lbs	280ft/lbs	18MM	170ft/lbs	240ft/lbs



INSTALLATION INSTRUCTIONS

1. Jack up the front of the ATV and place on jack stands. Remove the wheels.
2. Remove the lower and upper bolts for the stock bumper using a 13mm socket/wrench. **See Photo 1 and Photo 2.**

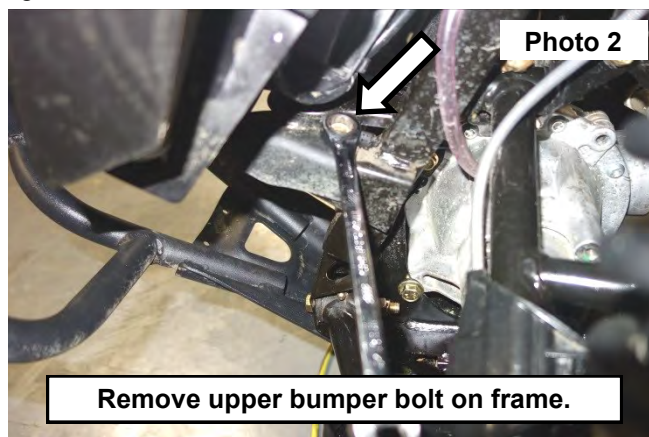
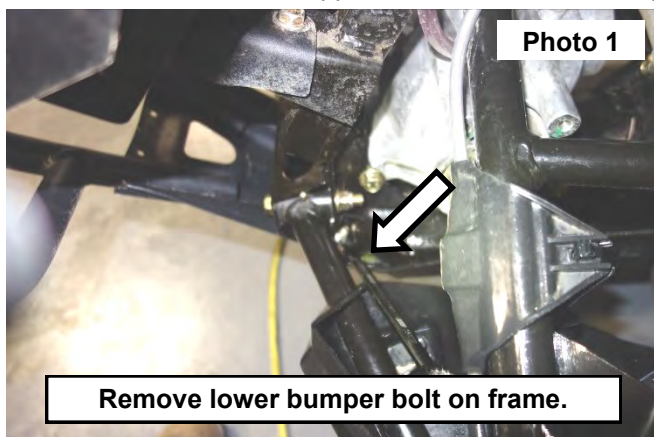

3. Remove the bolts from the bumper using a 13mm socket/wrench and a T40 Torx bit. **See Photo 3.**
4. Remove the bolt on the bumper support plate using 10mm socket/wrenches and remove the bumper from the ATV. **See Photo 4.**

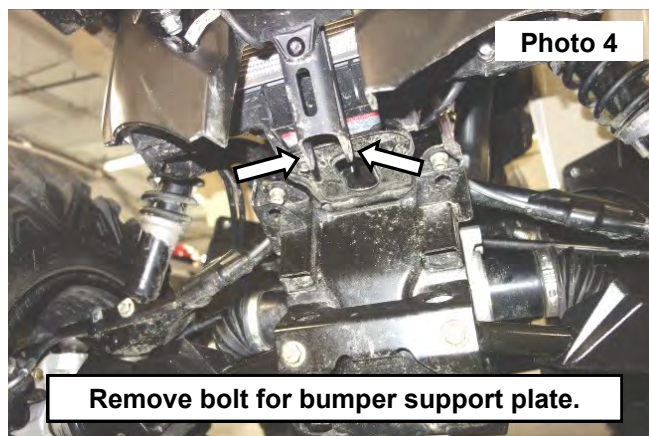
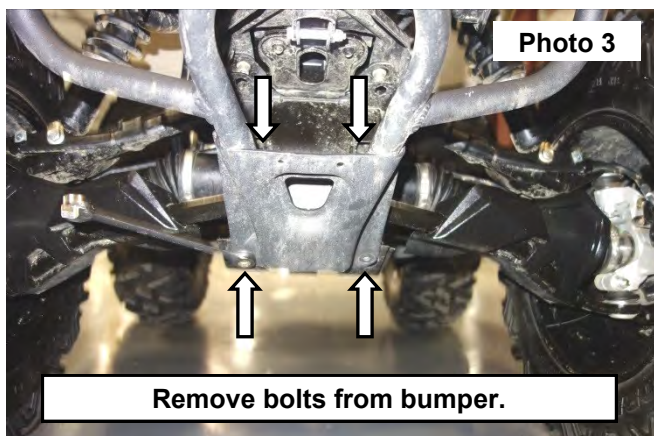

5. Remove the center bolt on the bumper mount using a 10mm socket/wrench and a T30 Torx bit. **See Photo 5.**
6. Remove the side bolt on the bumper mount using a 10mm socket/wrench. **See Photo 6.**

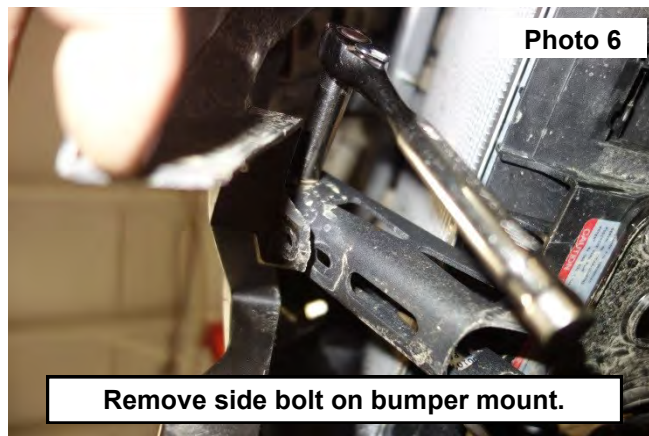
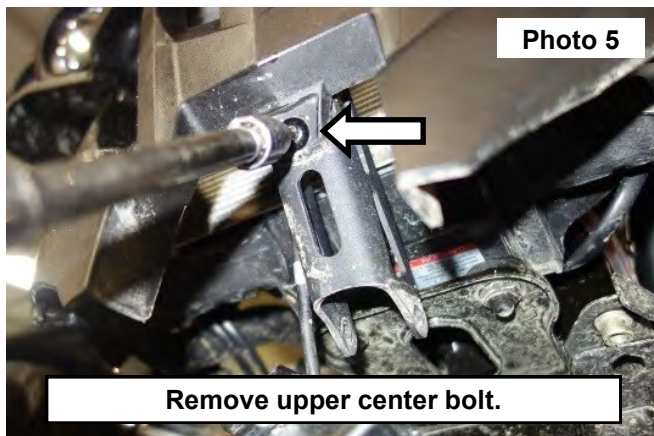

7. Install light bar in RC bumper using hardware supplied with the light. **See Photo 7.**
8. Install the RC bumper to the bumper mount plate using the 10mm hardware. **See Photo 8.**

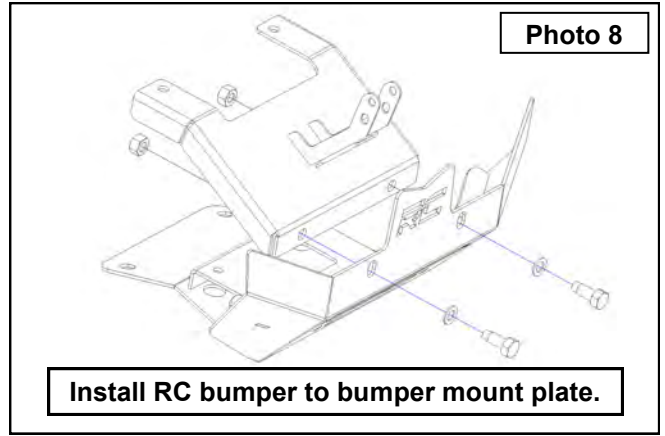
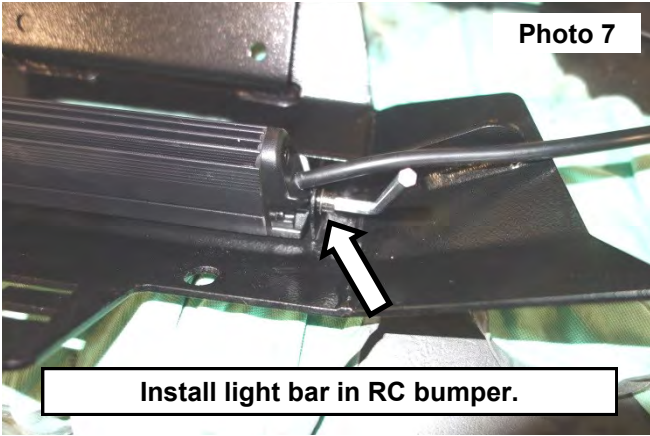

9. Install the hawse fairlead using the hardware supplied with the winch. **See Photo 9.**
10. Install the winch to the RC bumper using the hardware supplied with the winch. **See Photo 10.**

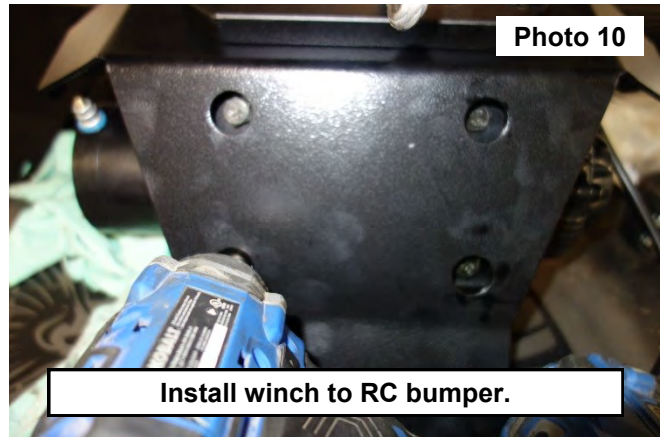

11. Install the winch bumper assembly to the UTV at the upper bumper mount using stock hardware. **See Photo 11 and Photo 12.**

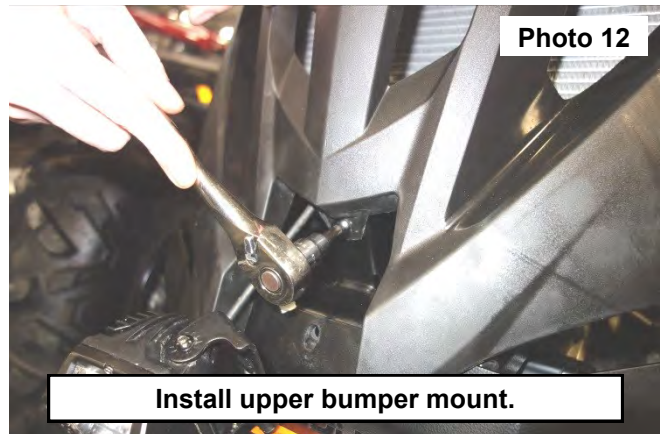
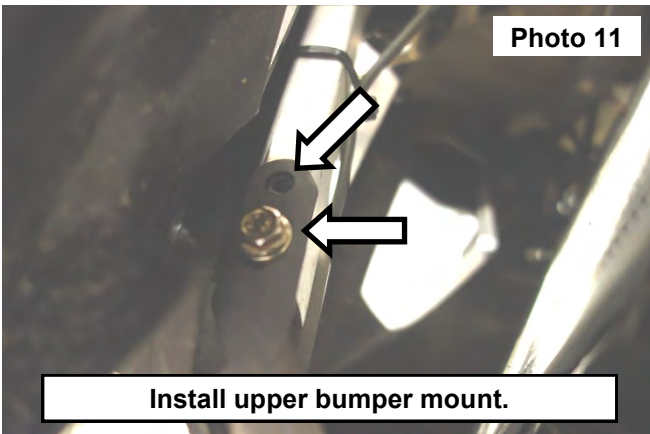

12. Install the bumper to the frame using the stock hardware. See Photo 13 and Photo 14.

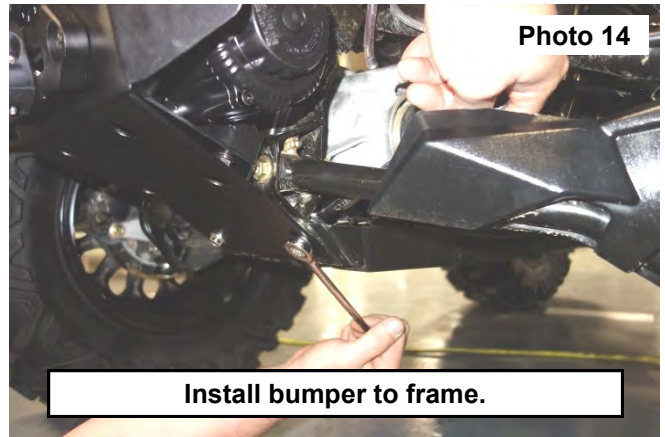
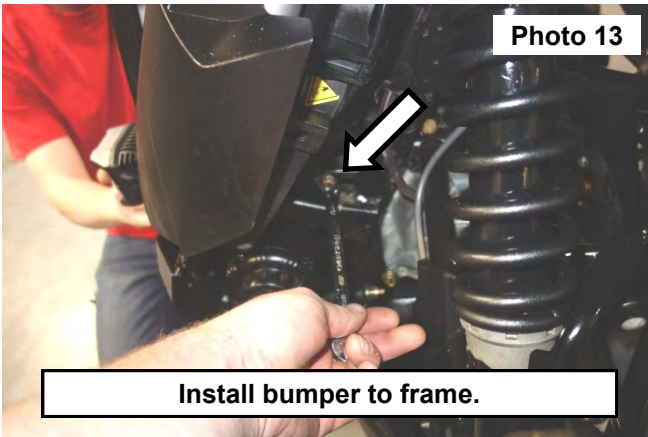

13. Connect the light bar to the ATV using the instructions with the light.



By purchasing any item sold by Rough Country, LLC, the buyer expressly warrants that he/she is in compliance with all applicable, State, and Local laws and regulations regarding the purchase, ownership, and use of the item. It shall be the buyers responsibility to comply with all Federal, State and Local laws governing the sales of any items listed, illustrated or sold. The buyer expressly agrees to indemnify and hold harmless Rough Country, LLC for all claims resulting directly or indirectly from the purchase, ownership, or use of the items.

