



INSTALLATION GUIDE

PART NUMBER: 15005/16005
LOWERING COILOVER
2WD: -1" TO -3" | 4WD: -1" TO -4"
RAM 1500 | 2019+
****NON-CLASSIC****

300 W. PONTIAC WAY. CLOVIS, CA 93612
PHONE: 800-445-3767 | EMAIL: INFO@BELLTECH.COM

THANK YOU

Thank you for choosing our high quality Belltech product. We have spent a great deal of time developing our line of products so that you will receive maximum performance with minimal difficulty during installation. Soon your vehicle will be on the road looking and feeling much improved.

Please take a moment to read all instructions and warnings prior to installation of your new Belltech product and before operating your vehicle. If you have any questions or concerns regarding any step in the installation process, please do not hesitate to call or email our customer support specialists who are trained to help you through any portion of this process.

Before You Begin:

It is of the utmost importance that you confirm all of the components listed on the parts list is in the kit. You can find this list located on the last page(s) of your instructions. Do not begin installation if any part is missing. Instead, please call our Belltech customer service specialists.

Belltech Customer Support:

Phone: 1-800-445-3767

Email: info@belltech.com

Safety Information:

Warning: Do not work under a vehicle supported only by a jack. Place support stands securely under the vehicle in the manufacturer's specified locations unless otherwise instructed.

Proper use of safety equipment and eye/face/hand protection is absolutely necessary when performing any of the following instructions.

We strive for an exceptional experience for all our valued customers. If for any reason you need assistance with your Belltech products, please do not return the product to the store you purchased from, but rather call our dedicated customer service experts, from 6am to 5pm PST.

We recommend that a qualified mechanic, at a properly equipped facility, perform this installation.

It is very helpful to have an assistant available during installation.

Before Driving Your Vehicle:

It is important to double check all brake hoses, cables, and other components to be sure there is no interference. You must also check for wheel/tire to chassis/body interference. If any issues are found, review your installation instructions to be sure no steps were missed and any problems are corrected.

Make sure your vehicle is aligned immediately following installation.

Check all hardware and re-torque at intervals for the first 10, 100, and 1000 miles.

Some of Belltech's products are designed to improve your vehicle's off-road performance. Leveling/lifting your vehicle may result in an altered center of gravity. It is crucial to use extreme care when operating your vehicle to prevent rollover and/or loss of control.

Any changes in your vehicle's suspension may result in transformed handleability. Please test-drive your vehicle in a remote location so you can become accustomed to the revised driving characteristics.

Perform headlight check and adjustment.

Failure to drive any modified vehicle in a safe manner may result in harm or death.

Never operate your modified vehicle under the influence of drugs, alcohol, or lack of adequate sleep.

Always wear your seatbelt.



DIFFICULTY:

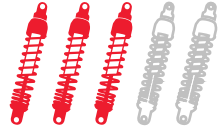

INSTALLATION TIME:

1-2 Hours
Per Coilover
+Alignment

RECOMMENDED TOOLS:

- Properly rated floor jack
- Wheel chocks
- Metric socket wrench set
- Metric wrench set
- Tape measure
- Marking Pen
- Dead blow hammer

SPECIALTY TOOLS:

- Torque wrench up to 200lbs
- Spring compressor
- Panel popping tool



Technician note:

Before making any adjustments to your new Belltech coilover, please be sure to loosen the set screw. Failure to do so will damage the threads. After the adjustments are made, you may then tighten the set screw to keep the settings in place.

INSTALLATION PREPARATION:

Before beginning the installation process, measure the hub to fender heights for your vehicle and record them in the “Before” section. After your vehicle has been modified, record the new measurements in the, “After” section. This way, you can compare the resulting height to the original. When taking the measurements, measure vertically from the center of the wheel to the inner edge of the fender.

Before:

LF: _____

RF: _____

LR: _____

RR: _____



After:

LF: _____

RF: _____

LR: _____

RR: _____

JACKING, SUPPORTING, AND PREPARING THE VEHICLE

1. Park your vehicle on a smooth, level, concrete or seasoned asphalt surface.
2. Block the rear wheels of the vehicle using wheel chocks. Make sure the vehicle's transmission is in "PARK" (automatic) or 1st gear (manual).
3. Activate the parking brake.
4. Loosen, but do not remove, the front wheel lug nuts.
5. Lift the front of the vehicle off the ground using a properly rated floor jack. Lift the vehicle so the front tires are approximately 6-8 inches off the ground.
6. Place support stands rated for the vehicles weight. The stands should be positioned in the factory specified locations. (Refer to owners manual). Prior to lowering the vehicle onto stands, make sure the support stands will contact the chassis. It is very important that the vehicle is properly supported to prevent any harm to ones self or to the vehicle.
7. Lower the vehicle slowly onto the stands.
8. Remove the front wheels.



Technician reminder:

Never work under a vehicle supported only by a jack. It is necessary to place support stands securely under the vehicle in the manufacturer's specified locations unless otherwise instructed.

OEM STRUT REMOVAL

9. Using a marking pen, mark all four alignment cams to reference placement later. Use a 24mm wrench to remove the four lower control arm bolts.

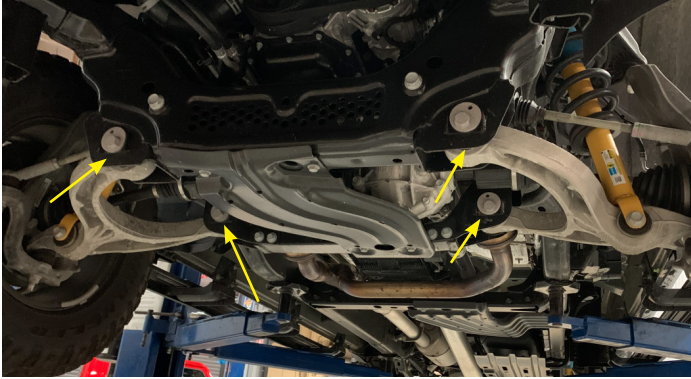

10. Use an 18mm socket to remove the sway bar end links.



11. Remove the bottom OE strut fork bolt using both a 21mm and a 24mm wrench.



12. Swing the control arm down and away from the strut.



OEM STRUT REMOVAL CONTINUED

- Using a panel popping tool, unclip the harness clip.



- Remove the three upper strut nuts using a 15mm wrench.
- Once all of the nuts have been unbolted, remove the strut from the vehicle.

STRUT DISASSEMBLY

- Mount the entire spring/strut assembly in the fixture. To ease the installation of the new strut, mark the position of the top mount in relationship to the upper spring isolator and strut body.
- Compress the spring until tension is relieved from the strut.



Technician note:

The installation photograph shown was taken at a professional installation shop. It is important to use a spring compressor to compress the spring before removing the top mount bolt. Failure to do so may result in serious injury.



- Remove top mount and upper rubber isolator. You will use these with your new Belltech coilover later.
- Remove the top mount, top spring perch, and dust boot.
- Remove the spring and strut from the fixture.

BELLTECH COILOVER HEIGHT SETUP AND ASSEMBLY

21. The coilover comes as shown below. Remove the nylock nut from the top of the Belltech coilover.

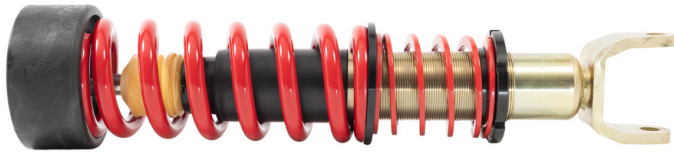

Technician note:

When lowering your Ram 1500 more than -1", OE camber may not be achievable. Ensure proper toe alignment to minimize tire wear.

When paired with Belltech's lowering spindles, set number 2652, OE alignment may be obtained, up to a -5" drop.

22. Using the tables below as reference, remove the main spring and slide the required packers onto the strut rod.

2019+ Ram 1500 2WD (Non Classic)		
Drop (Inches)	Perch height (milli-meters/inches)	15mm Packer
-1"	211mm/8.3in	1
-2"	193mm/7.6in	0
-3"	175mm/6.9in	0

2019+ Ram 1500 4WD (Non Classic)		
Drop (Inches)	Perch height (milli-meters/inches)	15mm Packer
-1"	229mm/9.0in	1
-2"	211mm/8.3in	1
-3"	193mm/7.6in	0
-4"	175mm/6.9in	0



Technician note:

Belltech uses packers to maintain the correct bump stop engagement at various height ranges. Using the appropriate packer will prevent excessive body roll. If a packer is needed, according to the above charts, please place the packer on top of the vent disc, channel side down, as shown by the image to the right of this text box.

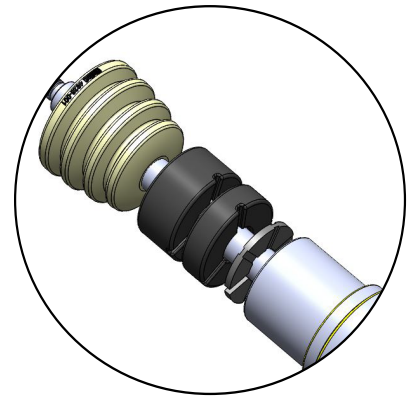

23. Confirm the vent disk is located on the strut, under the dust boot. If for any reason your vent disk is not present, please call our technical support staff before proceeding, as driving on the strut without it could cause the shock to fail.

24. Loosen the set screw on the spring perch.

25. Using the provided spanner wrench, turn the bottom spring perch to obtain desired spring perch height, measuring from the top of the perch to the center of the bushing. Find the appropriate spring perch height by referencing the tables above. We do not recommend adjusting beyond what is shown on the tables, as the performance of the shock may decrease greatly.

26. Tighten the set screw.

27. Push the OE top mount, with the rubber isolator, into the Belltech upper spring seat.

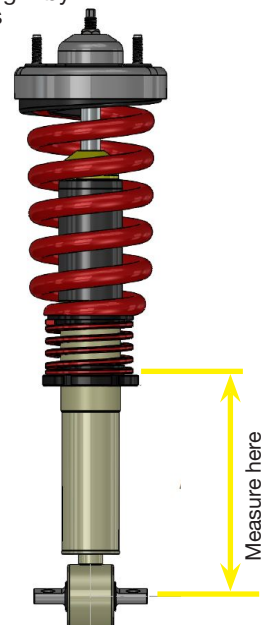
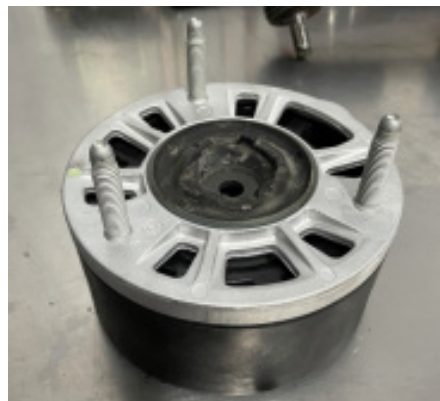

BELLTECH COILOVER HEIGHT SETUP AND ASSEMBLY CONTINUED

29. Assemble the helper spring, intermediate ring, main spring, upper spring seat, upper rubber isolator, and OE top mount onto the Belltech coilover.
30. Torque the supplied nylock nut onto the strut. Reference the OE strut markings and ensure the top mount is oriented in the same fashion it was before disassembly.

COILOVER INSTALLATION

31. Slide the Belltech coilover into the OE strut's original placement.
32. Using a 15mm wrench, tighten the upper strut nuts onto their correlating bolts.
33. Re-clip the harness clip.
34. Move the control arm back into place towards the coilover.
35. Using a 21mm and a 24mm wrench, reattach the OE strut fork blot.
36. Use an 18mm socket to reattach the sway bar end links.
37. Use a 24mm wrench to reattach the 4 lower control arm bolts.
38. Replace all four alignment cams by referencing the original marks you made with your marking pen. Tighten the cams with the full weight of the vehicle on the suspension.



Technician note:

Installation of your strut will be performed in the reverse order of removal. If it helps you to have photographs to reference, you may view the photographs from steps 9 through 15.

FINALIZING THE INSTALLATION

39. Re-install the wheels and tighten the lug nuts.
40. Lift the vehicle and remove the support stands.
41. Carefully lower the vehicle onto the flat ground.
42. Torque the lug nuts to manufacturer's specifications.
43. Check that all components and fasteners have been properly installed and torqued.
44. Re-read and perform all tasks in the "Before Driving Your Vehicle" section of page 1 of your instructions.



Technician note:

If you purchased the adjustable version of this coilover, part number 16005, please refer to the page 11 of this instruction. After all installation steps are complete, we suggest driving on your new coilovers at their factory settings before adjusting the knobs to your preferences.

THANK YOU FOR CHOOSING BELLTECH.

You are now a part of the Belltech family and we are eager to catch a glimpse of your newly modified vehicle. Give us a shout out and let us know how much you love our product. Don't forget, we offer other Belltech related merchandise for you and your vehicle on our website, www.belltech.com!

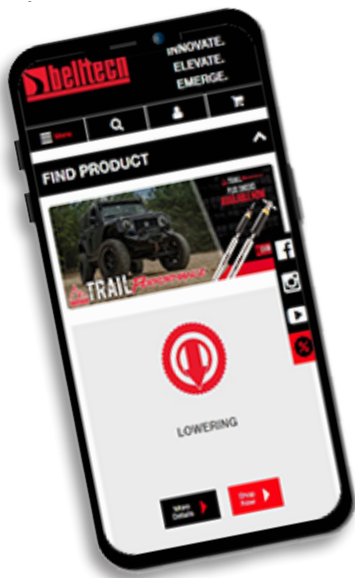

belltechsuspension



Belltech Suspension



@belltechsuspension

If you have any questions, concerns, or warranty related issues regarding your Belltech product, please call or email our experienced customer service specialists.

Belltech Customer Support:

Phone: 1-800-445-3767

Email: info@belltech.com

KIT CONTENTS (15005)



15005		
Part number	Description	Qty
15005-100	Belltech Coilover	2
68510039	Spanner Wrench	1

15005-100		
Part number	Description	Qty
15005-245	Coilover Damper	1
15105-003	Coilover Spring Adapter	1
4935-001	15mm Bump Stop Packer	2
65210799	Bump Stop	1
65210800	Dust Boot	1
15002105	Vent Disc	1
NUT	M12x1.25mm Flanged Nylock	1
68320103	M5x12 Set Screw	1
70150-240-993	Linear Spring	1
15000-003	Intermediate Ring	1
4001-001	Helper Spring	1
65050018	Spring Perch	1

KIT CONTENTS (16005)



16005		
Part number	Description	Qty
16005-100	Belltech V3 Coilover	2
68510039	Spanner Wrench	1
68525101	Adjustment Knob	1

16005-100		
Part number	Description	Qty
64128011	Belltech V3 Damper	1
15105-003	Coilover Spring Adapter	1
65210799	Bump Stop	1
65210800	Dust Boot	1
68320103	M5x12 Set Screw	1
70150-240-993	Linear Spring	1
15000-003	Intermediate Ring	1
4001-001	Helper Spring	1
65050018	Spring Perch	1
65210803	Vent Disc	1
65210021	Packer	2

REBOUND AND COMPRESSION KNOB ADJUSTMENT (16005 ONLY)

Before you begin, it is important to note that making changes to the rebound and compression valves will alter your vehicle's driving dynamics. Please adjust all settings safely and in small increments so you are able to get familiar with the new driving characteristics. Your shocks, both left and right should always mirror each others' settings.

Compression and rebound forces are increased when turning the corresponding knobs clockwise and decreased when turned counter-clockwise. Clicks are counted from zero, which is fully closed, upwards, to fully open.

When you receive your Belltech coilover, the rebound and compression will be preset. Rebound will be set to 9 clicks and compression will be set to 4 clicks.

To adjust the rebound, use the supplied knob.



Adjust the compression by turning the bottom, built-in knob clockwise or counter-clockwise.

