



INSTALLATION INSTRUCTIONS

153712 and 153713

6" - 8" LIFT KIT 4WD / 6" - 9" LIFT KIT 2WD

300 W. Pontiac Way Clovis, CA 93612 toll free: 1-800-445-3767 web: www.belltech.com

19+ RAM 1500 2WD/4WD ****Excludes classic and eTorque models****

Thank you for being selective enough to choose our high quality BELLTECH PRODUCT. We have spent many hours developing our line of products so that you will receive maximum performance with minimum difficulty during installation

Note: Confirm that all of the hardware listed in the parts list is in the kit. **Do not** begin installation if any part is missing. Read the instructions thoroughly before beginning this installation.

Warning: DO NOT work under a vehicle supported by only a jack. Place support stands securely under the vehicle in the manufacturer’s specified locations unless otherwise instructed.

Warning: DO NOT drive vehicle until all work has been completed and checked. Torque all hardware to specified values.

Reminder: Proper use of safety equipment and eye/face/hand protection is absolutely necessary when using these tools to perform procedures!

Note: It is very helpful to have an assistant available during installation.

Warning: Not all possible wheel sizes and backspacing can be tested. Cautiously check wheel assembly to spindle, suspension component, and fender/body clearance before tightening lug nuts and rotating the wheel assembly. Belltech is not responsible for any wheel, tire, suspension component, and/or body damage caused by failure to check for interference.

Exceptional Customer Experience Guarantee:

STOP! We strive for an exceptional experience for all of our valued customers. If, for any reason, you need assistance with your Belltech products, please do not return the products to the store or website you purchased from. Please call our dedicated experts at (1-800-445-3767) from 7am to 5pm PST.

RECOMMENDED TOOLS:

- Properly rated floor jack and support stands
- Wheel chocks
- Torque wrench up to 200 ft/lbs range
- Metric socket wrench set
- T-30 Torx bit
- 5mm hex key
- Metric wrench set
- Tape measure
- Dead blow hammer
- Marking pen
- Safety Glasses
- Reciprocating Saw and/or Angle grinder with Metal cutting



DIFFICULTY:



INSTALLATION TIME: 6-8hrs

Before you continue, please take a look under your vehicle's hood. If your vehicle contains a DC charger as shown, you have an eTorque model and our kit will not work with your truck. If this is the case, please contact the vendor you purchased your Belltech kit from to begin the return process.



1) KIT PREPERATION

- Minimum wheel specs: 18" diameter, 5" Backspacing
- Maximum recommended tire size: 37"x12.5" at 6" lift height with 5" wheel backspacing.
- Does NOT fit 2019+ "Classic" models (5 lug)

a) Before beginning the install process, measure the hub to fender heights for your vehicle so you can compare the resulting height to the original. Measure vertically from the center of the wheel to the inner edge of the fender. Reference **(PHOTO 1)** Record the results here:

Stock:

LF: _____ RF: _____ LR: _____ RR: _____

With 153712 Kit Installed:

LF: _____ RF: _____ LR: _____ RR: _____

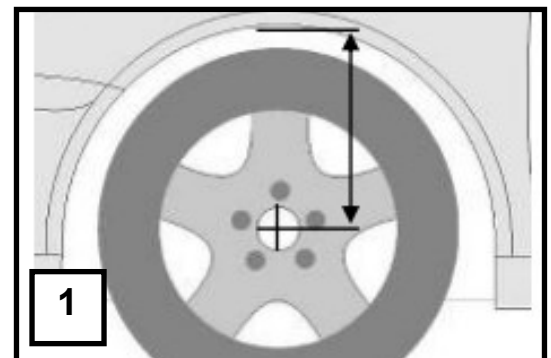

b) Park the vehicle on a smooth, level concrete or seasoned asphalt surface and activate the parking brake. Block the rear wheels of the vehicle with appropriate wheel chocks; making sure the vehicle's transmission is in 1st gear (manual) or " Park" (automatic).

! It is very important that the vehicle is properly supported during this installation to prevent personal injury and chassis damage. Make sure that the support stands are properly placed prior to performing the following procedures.

2) FRONT REMOVAL INSTRUCTIONS

- a) Jack up the front of the vehicle. Place jack stands under the frame rails and lower onto jack stands letting the front suspension hang.
- b) Undo the lug nuts and remove wheels.
- c) Remove the factory skid plate and plastic guards if equipped. **(PHOTO 2)**
- d) Remove the sway bar and end links from the vehicle. **(PHOTO 3)**
- e) Loosen the jam nuts on the tie rods. Remove the tie-rod nuts from spindles. **(PHOTO 4)** Strike the side of the mount with a hammer, or use a puller to dislodge the tie rod end. Remove outer tie rod from inner tie rod.
- f) Remove all mounting points for the brake line and ABS sensor wire from the upper control arm and spindle.
- g) Undo the brake caliper mounting bolts located at the back of the spindle. Hang the calipers on the frame to prevent stretching of the lines using large zip ties or hangers. **(PHOTO 5)**



- h) Remove the rotor using a T-30 Torx. **(PHOTO 6)**
- i) Remove the ABS sensor from the steering knuckle using a 5mm Allen. **(PHOTO 7)**
- j) (4WD only) Remove the axle nut from the hub. Dislodge the axle pin from the hub using a hub puller if needed. **(PHOTO 8)**
- k) Loosen but do not fully remove the upper ball joint nut. Strike the spindle on the designated bosses to help separate the upper control arm from the spindle. **(PHOTO 9)**
- l) Loosen but do not fully remove lower ball joint nut and strike it on the designated areas to separate from the lower control arm. **(PHOTO 10)**



- m. Remove the bottom OEM strut fork bolt. **(PHOTO 11)**
- n. Support the spindle, remove both ball joint nuts, and remove spindle from vehicle.
- o. Remove the lower control arm bolts and remove the control arms from the vehicle.
- p. Remove the OEM strut by loosening the top three bolts in the strut tower. **(PHOTO 12)**
- q. Remove the OEM axles. A hammer or pry bar may be needed to dislodge the axles from the differential. **(PHOTO 13)**

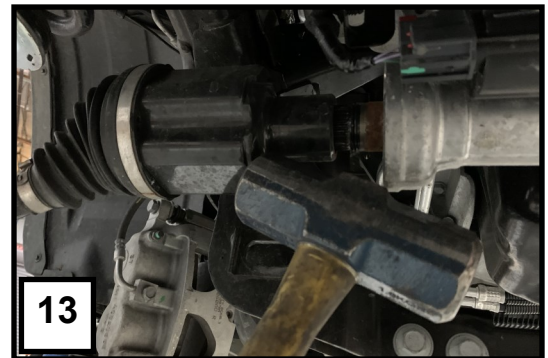

3) (4WD only) OEM DIFFERENTIAL REMOVAL

- a. Unbolt the four bolts on the rear crossmember near the front differential. remove the rear crossmember from between the mounting points. **(PHOTO 14)**
- b. Disconnect the electronics connected to the differential before unbolting or lowering it.
- c. Support the differential from below.
- d. Unbolt and disconnect the driveshaft from the differential.
- e. Locate all the bolts that mount the differential to the frame. 2 bolts are located on the passenger side. 2 more bolts are located above the differential; the last 3 bolts are located towards the back of the differential on the driver side.

- f. Remove the differential, being careful not to damage surrounding components.
- g. Using the outer edge of the OEM alignment tabs on the drivers rear lower control arm mount, measure 19.00mm (0.75") towards the center of the vehicle and mark vertically using a paint pen. Do this on the front and rear of the bracket, and connect the lines across the top **(PHOTO 15)**.
- h. Use a reciprocating saw or angle grinder to cut along the painted line.
- i. Once the cut is complete; grind any sharp edges and paint any exposed metal with spray paint to prevent future rust. **(PHOTO 16)**



4) (4WD only) INSTALLING BELLTECH 153712-104 DIFFERENTIAL BRACKETS (PHOTOS 17,18,19)

- a. Install the differential drop brackets to the vehicle. Use OE hardware for the front bracket, and the supplied hardware for the rear bracket. Keep bolts loose, allowing for slight movement in the brackets to ease with installing the differential.
- b. Lift the differential back into the vehicle and install it into the differential drop brackets using the supplied hardware for the front and OE hardware for the back mount.
- c. On the passenger side, flip and re install the OEM harness bracket onto the differential bracket and route the wires as shown. **(PHOTO 19)** Release harness retainer clips as needed to get proper slack in the wires. Tighten all the hardware connecting the differential to the bracket, then the brackets to the frame. Use OE torque spec for all differential hardware.
- d. Reconnect the differential electronics.

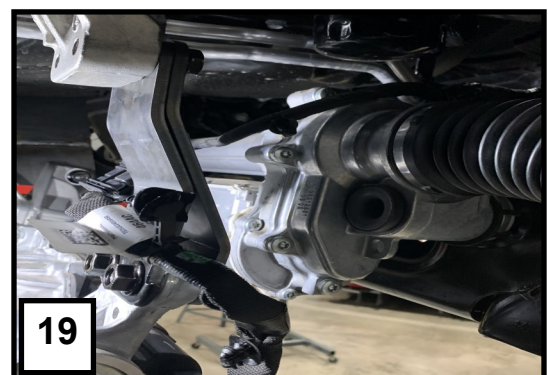

- e. Trim the plastic guard underneath the shift cable on the left side of the transmission for driveline clearance as shown. Sand to prevent sharp edges. **(PHOTO 20)**
- f. Using supplied hardware, install the supplied drive line spacer between the front differential and the front drive shaft. **(PHOTO 21)**



5) INSTALLING LIFT KIT

- a. Install the new front and rear crossmembers using the supplied hardware. Torque to 180 ft lbs. **(PHOTO 22)**
- b. Install the lower control arms into the crossmembers using OEM hardware. Hand tighten. do not torque yet. **(PHOTO 23)**



For Strut Spacer Installation:

Please refer to the included instructions for strut spacer 153712-120. All required hardware is provided.

For Trail Performance Strut or Coilover Installation:

Please refer to the instructions for 28020 or 15305.

For both instances, use the OE hardware to mount the strut to the vehicle.



- c. Mount the lower strut mount to the OEM lower control arms. **(PHOTO 24)**



- d. Transfer the hubs and brake backing plates from the OEM spindles into the lifting spindles. Be sure the backing plate and ABS port are installed in the right orientation. **(PHOTO 25)**
- e. (4WD only) Reinstall the CV axles into the differential. Push onto the splined shaft until you feel it pop into place.
- f. Slide the lifting spindle assembly back onto the CV axle (4wd only) and lower ball joint. Hang in place using the lower ball joint nut. **(PHOTO 26)**
- g. Attach upper control arm Ball joint to the spindle. A jack may help support the weight of the spindle. **(PHOTO 27)**
- h. (4WD only) Ensure that the axle has aligned correctly into the hub. Install and torque the Axle nut onto the CV axle. **(PHOTO 28)**
- i. Reinstall the ABS Line, Route the wire behind the brake backing plate and under the steering arm on the spindle. **(PHOTO 29)**

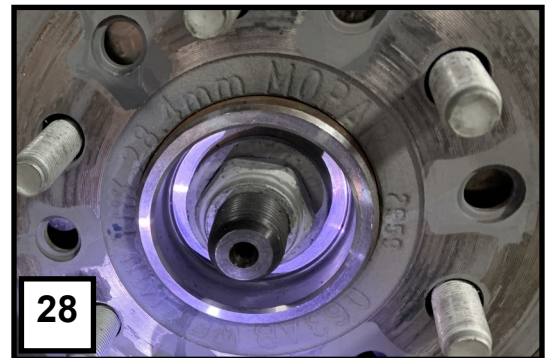
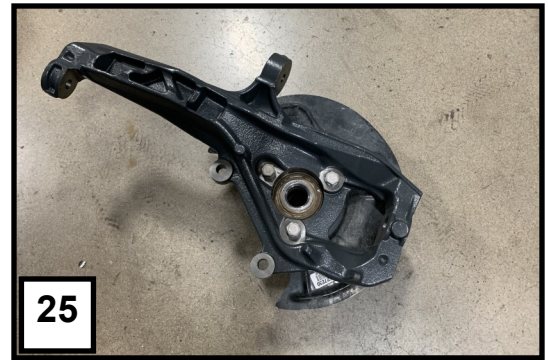

- j. Unbolt front brake line brackets from the frame. **(PHOTO 30)**
- k. Disconnect the soft brake line from the caliper and upper compression fitting. **Please follow proper safety precautions when removing brake lines. Brake fluid is highly corrosive and should be contained in any way possible.**
- l. There are 2 possible extended brake lines that may be included with your kit. **(PHOTO 31)** One uses a factory style mounting bracket and the OE bolt, and the other uses the included retaining clip. Install the new brake line onto the vehicle. If necessary, open the hole in the frame slightly.
- m. Install the rotors and brake calipers onto the lifting spindle. Install the rotor locating bolt.
- n. Using an angle grinder, cut 1/4" from the inner tie rods. It will be helpful to keep the jam nut on the threads and to run it back out over the cut threads to ensure the threads are aligned properly after cutting. **(PHOTO 32)**
- o. Install the new outer tie rods to the cut inner tie rods, then into the spindle. **(PHOTO 33)**



For sway bar or sway bar drop down bracket installation:

- Please refer to the included instructions for your selected sway bar kit. **9938 or 5437**
- If your kit came with **LK74000** (sway bar drop down brackets), and did NOT come with a Belltech sway bar, please reference the last page of this instruction for steps to install your OE sway bar using your new Belltech sway bar drop down brackets.

- p. Install skid plate using provided hardware. **(PHOTO 34)**
- q. Tighten all installed hardware to OEM specs.
- r. **IMPORTANT** Perform factory recommended brake bleeding procedure. The rear brakes will not be disconnected so a full bleed should be performed at this time. **Failure to properly bleed brakes will result in brake failure.**
- s. Reinstall the wheels and lower the vehicle to the ground. Torque control arms to factory spec. Torque lug nuts to factory spec.

6) REAR REMOVAL INSTRUCTIONS

- a) Jack up the rear of the vehicle. Place jack stands under the frame rails and lower onto jack stands letting the rear suspension hang.
- b) Disconnect brake line brackets from each side of the frame. **(PHOTO 1)**
- c) Disconnect ABS wire bracket from crossmember above the differential with a 10mm socket. **(PHOTO 2)**
- d) Using a pry tool, disconnect the 2 rear plastic clips on the hard brake line on either side to separate them from the frame, and allow them to move downward to accommodate for the lift. **(PHOTO 3)**
- e) Using an 8mm wrench, remove rear fender liners. **(PHOTO 4)**
- f) Supporting the differential with a floor jack, Remove Rear shocks. Lower hardware will be reused.
- g) Remove lower Track bar bolt and OE swaybar end links.
- h) Lower axle and remove both rear springs and rubber isolators.

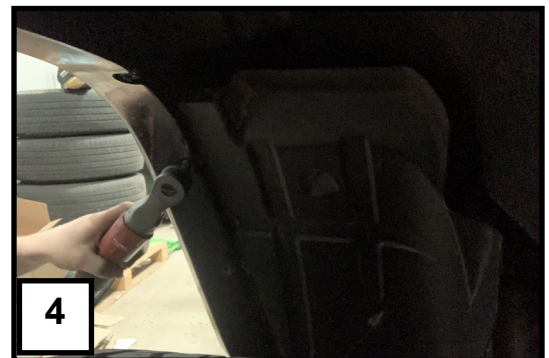
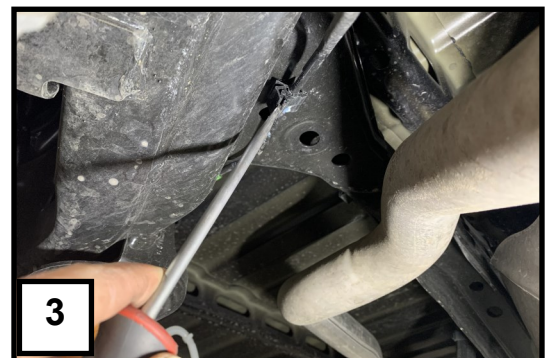
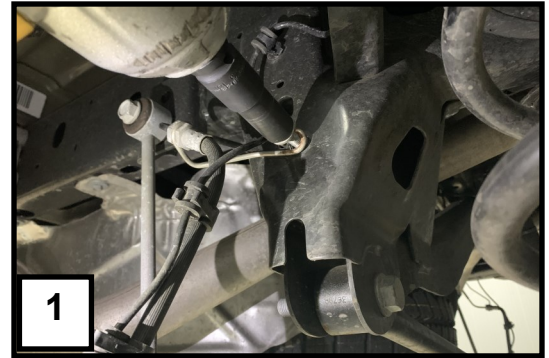

7) REAR INSTALL INSTRUCTIONS

Either support the axle with multiple stands, or work one side at a time for the rear control arm brackets.

- a) Loosen but do not remove axle-end control arm bolts. **(PHOTO 5)**
- b) Remove frame-end control arm bolts. These will not be reused.
- c) Install control arm drop bracket into frame with supplied M16 hardware and crush tubes. Do not tighten yet. **(PHOTO 6)**
- d) Install the supplied M14 bolt with washers through the hole in the front of the bracket and torque to 90ft Lbs.
- e) Torque both M16 bolts to 180 ft lbs.
- f) Install control arms into bracket using supplied M16 hardware. Do not tighten yet.
- g) Repeat steps a-f for other side if doing each side separately.



- h) (153712BK kit only) If using rear spring spacers, install them into the upper spring seats on the frame using supplied M8 nuts. **(PHOTO 7)**
- i) Lower the axle enough to install new rear springs with rubber isolators. (OE springs if using 153712BK kit)
- j) Raise the axle up and install new rear shocks with OE bolts on the bottom and provided hardware on the top.
- k) Install Rear brake line drop brackets to each side of the frame using OE hardware. Install brake lines to the brackets using supplied M8 hardware **(PHOTO 8, 9)**
- l) Install center ABS wire harness drop bracket to the frame with OE hardware. The bent locating tabs face toward the back of the truck with the 90 degree bend on the driver side. **(PHOTO 10)**
- m) Install the ABS wire harness to the lowering bracket using supplied M6 hardware

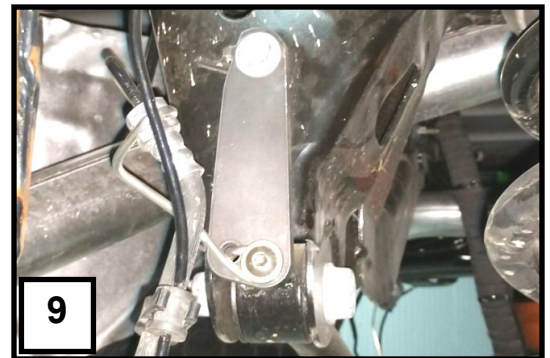
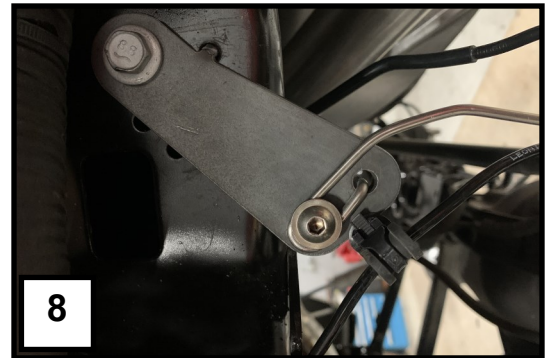

- n) Remove plastic wire retainer from the driver side of the track bar bracket on the axle. Drill the hole out with a 1/2" drill bit. **(PHOTO 11)**
- o) Install the track bar relocation bracket onto the axle. First install the M12 bolt with no washer on the head from the inside of the bracket through the hole you just drilled out in the previous step. Install the washer and nut on the M12 bolt. Loosely Install the provided M14 hardware and crush sleeve in the original track bar hole. **(PHOTO 12)**
- p) First, torque the M12 nut to 80 ft lbs, then torque the M14 bolt to 100 ft lbs
- q) Install the track bar to the bracket using OE hardware. It may help to bend the flag on the OE nut to allow it to hold onto the bracket and not spin. Do not torque yet.
- r) Install new sway bar end links using OE hardware up top, and the provided hardware on the bottom.
- s) Remove OE bump stops by pulling them out of their retaining cup.
- t) Install new bump stops and spacers with provided hardware as shown. Insert bolt from the bottom. **(PHOTO 13)**
- u) Install Wheels if removed and lower rear end onto the ground,
- v) Torque lug nuts, all control arm bolts, and track bar bolts to OE specs.
- w) Double check torque of all components and ensure no binding or pulling of brake lines and electrical cables.

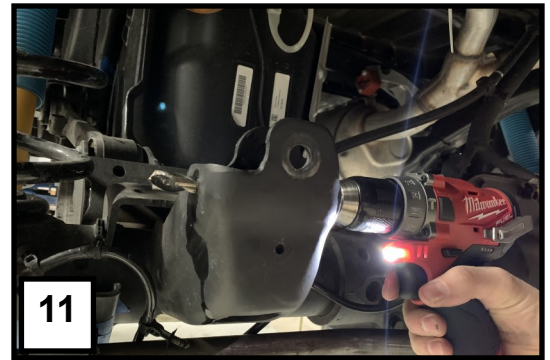

8) **Post Install**

- a) Check that all components and fasteners have been properly installed, tightened and torqued.
- b) Check brake hoses, and other components for any possible interference.
- c) Torque all lug nuts to OEM (factory) specifications.
- d) Test drive the vehicle in a remote location so that you can become accustomed to the altered driving characteristics and handling. Be aware that the vehicle will handle substantially different now that it has been modified.
- e) We recommend the vehicle be taken to a qualified wheel alignment facility to be realigned to factory specifications after completing the install.
- f) Installation is complete. Check ALL of the hardware and re-torque at intervals for the first 10, 100, 1000 miles.

KIT CONTENTS

LK71000		
153712A-777	Hardware Kit	1
153712-101-992	Front Crossmember	1
153712-102-992	Rear Crossmember	1

LK7001		
153712-205-99	Driver Rear Control Arm Drop	1
153712-206-99	Passenger Rear Control Arm Drop	1
153712-223-99	Track Bar Relocator	1
LK7001A	Sub Kit - A	1
153712-108-992	Skid Plate	1
153712-216	Rear Swaybar End Link	2

LK2652		
153712-103L	Driver Side Spindle	1
153712-103R	Passenger Side Spindle	1

LK7001A		
153712-110	Outer Tie Rod	2
4923-001	Bump Stop	2
153712-225-99	Brake Line Bracket	1
153712-226-99	Brake Line Bracket	1
153712-227-99	Brake Line Bracket	1
153712-203	Bump Stop Extension	2
153712-207-99	Control arm Bracket Crush Sleeve	4
153712C-777	Hardware Kit	1
153712D-777	Hardware Kit	1
153712E-777	Hardware Kit	1
153712F-777	Hardware Kit	1
153712G-777	Hardware Kit	1
153712H-777	Hardware Kit	1
153712-130	Front SS Brake Line Kit	1

LK30001 (4WD only)		
153712-104A-99	Main Differential Drop	1
153712-104B-99	Rear Differential Drop	1
153712-140-95	Drive Line Spacer	1
153712B-777	Hardware Kit	1

* The supplied shock, spring, and/or spacer sets will vary depending on the stage selection



HARDWARE KIT CONTENTS

HARDWARE KIT - 153712A-777		
110264	Bolt M18-2.5x140	4
110265	Nylon Lock Nut M18-2.5	4
153712-101W-99	Centering Washer M18	8

HARDWARE KIT - 153712B-777		
110225	Bolt M12-1.75x30	3
110282	Bolt M12-1.75x45	2
110243	Nylon Lock Nut M12-1.75	7
112151	Bolt M12x1.75	6
110228	Washer M12	18

HARDWARE KIT - 153712C-777		
110218	Bolt M16-2.0x120	8
110242	Nylon Lock Nut M16-2.0	8
110219	Washer M16	16
110283	Bolt Flanged M14-2.0x45	2
110222	Nylon Lock Nut M14-2.0	2
110223	M14 Washer	2

HARDWARE KIT - 153712D-777		
110246	Bolt M10-1.75x60	2
112292	Nylon Lock Nut M12-1.5	2
110228	Washer M12	4

LK74000		
153712I-777	Hardware Kit	1
153712-113L-99	Left Sway bar Drop Down	1
153712-113R-99	Right Sway Bar Drop Down	1

HARDWARE KIT - 153712E-777		
112103	Bolt M14-1.5x90	1
110292	Nylon Lock Nut M14-1.5	1
110223	Washer M14	2
110225	Bolt M12-1.75x30	1
110243	Nylon Lock Nut M12-1.75	1
110228	Washer M12	1

HARDWARE KIT - 153712F-777		
110232	Bolt M8-1.0x16	2
110233	Nylon Lock Nut M8-1.0	2
110245	Washer M8	4
110234	Bolt M6-1.0x16	1
110235	Nylon Lock Nut M6-1.0	1
110117	Washer M6	2

HARDWARE KIT - 153712G-777		
112142	Bolt Serrated Flanged M10-1.5x25	6

HARDWARE KIT - 153712H-777		
110287	Bolt Socket Head M10-1.5x130	2
110280	Nylon Lock nut M10-1.5	2
110239	Washer M10	2

HARDWARE KIT - 153712I-777		
110230	Bolt M10 x 1.25—25MM	4
110244	Nut (Nylock) M10-1.25	4
110239	Washer Flat M10	8

* The supplied shock sets will vary depending on the stage selection purchased.



SWAY BAR DROP DOWN BRACKET INSTALLATION
(FOR OE SWAY BAR ONLY):

1. Install the supplied sway bar drop brackets, with solid side facing outward, on the frame using the factory hardware. Do not yet tighten.
2. Install the sway bar assembly on the drop down brackets using the hardware in your 153712I-777 hardware kit. Torque all hardware to 30ft/lbs.
3. Reference back to step "P" of the main instructions.

