



INSTALLATION INSTRUCTIONS



**2014-2018 GM C/K1500
3" SYSTEM w/UNIBALL UPPER CONTROL ARMS
FOR USE WITH FACTORY ALUMINUM & STAMPED STEEL SUSPENSION
ONLY**

FTS21144 - SYSTEM w/PERFORMANCE SHOCKS

FTS21191 - SYSTEM w/STEALTH SHOCKS

FTS21206 - SYSTEM w/DIRT LOGIC SHOCKS

FTS21220 - SYSTEM w/DIRT LOGIC RESI SHOCKS

Fabtech Motorsports | 4331 Eucalyptus Ave. Chino, CA 91710

Tech Line: 909-597-7800 | Fax: 909-597-7185 | Web: www.fabtechmotorsports.com

- PARTS LIST -

	FTS21144	3" SYSTEM W/PERFORMANCE SHOCKS
1	FT20585BK	UCA (DRIVER)
1	FT20586BK	UCA (PASSENGER)
4	FT1500U	U-BOLT
2	FT20801	SHOCK SPACER
1	FT20625	DIFF MOUNT (DRIVER)
1	FT20626	DIFF MOUNT (PASSENGER)
1	FT20627BK	SKID PLATE
1	FT20589	HARDWARE KIT
1	FT20622	HARDWARE SUBASSEMBLY
1	FT90118	BUSHING KIT
2	FTBK15	BLOCK 1.5"
2	FTS7333	REAR PERFORMANCE SHOCK

	FTS21206	3" SYSTEM W/DIRT LOGIC SHOCKS
1	FT20585BK	UCA (DRIVER)
1	FT20586BK	UCA (PASSENGER)
4	FT1500U	U-BOLT
1	FT20625	DIFF MOUNT (DRIVER)
1	FT20626	DIFF MOUNT (PASSENGER)
1	FT20627BK	SKID PLATE
1	FT20589	HARDWARE KIT
1	FT20622	HARDWARE SUBASSEMBLY
1	FT90118	BUSHING KIT
2	FTBK15	BLOCK 1.5"
2	FT825282	FRONT DIRT LOGIC 2.5 COILOVER
2	FTS810152	REAR DIRT LOGIC 2.25 NON RESI SHOCKS
1	FT86043	HARDWARE KIT

	FTS21191	3" SYSTEM W/STEALTH SHOCKS
1	FT20585BK	UCA (DRIVER)
1	FT20586BK	UCA (PASSENGER)
4	FT1500U	U-BOLT
2	FT20801	SHOCK SPACER
1	FT20625	DIFF MOUNT (DRIVER)
1	FT20626	DIFF MOUNT (PASSENGER)
1	FT20627BK	SKID PLATE
1	FT20589	HARDWARE KIT
1	FT20622	HARDWARE SUBASSEMBLY
1	FT90118	BUSHING KIT
2	FTBK15	BLOCK 1.5"
2	FTS6333	REAR STEALTH SHOCK

	FTS21220	3" SYSTEM W/DIRT LOGIC RESI SHOCKS
1	FT20585BK	UCA (DRIVER)
1	FT20586BK	UCA (PASSENGER)
4	FT1500U	U-BOLT
1	FT20625	DIFF MOUNT (DRIVER)
1	FT20626	DIFF MOUNT (PASSENGER)
1	FT20627BK	SKID PLATE
1	FT20589	HARDWARE KIT
1	FT20716	HARDWARE SUBASSEMBLY
1	FT90118	BUSHING KIT
2	FTBK15	BLOCK 1.5"
1	FT820282D	FRONT DIRT LOGIC 2.5 COILOVER W/RESI
1	FT820282P	FRONT DIRT LOGIC 2.5 COILOVER W/RESI
2	FTS810152	REAR DIRT LOGIC 2.25 NON RESI SHOCKS
2	FT83368BK	RESI MOUNT

- PARTS LIST -

	FT20622	HARDWARE SUBASSEMBLY
4	FT147	MISALIGNMENT
2	FT94503	UNIBALL ADAPTER PIN
1	FT21144I	INSTRUCTIONS
1	FT916H	9/16" U-BOLT HARDWARE KIT
1	FTAS16	DRIVER WARNING DECAL
1	FTREGCARD	REGISTRATION CARD

	FT20716	HARDWARE SUBASSEMBLY
4	FT147	MISALIGNMENT
2	FT94503	UNIBALL ADAPTER PIN
1	FT21144I	INSTRUCTIONS
1	FT916H	9/16" U-BOLT HARDWARE KIT
1	FTAS16	DRIVER WARNING DECAL
1	FTREGCARD	REGISTRATION CARD
1	FT86049	HARDWARE KIT 49

	FT90118	BUSHING KIT
4	FTS1001	A-ARM BUSHING
4	FT1002	BUSHING UCA HALF
4	FT1500-6-101	SLEEVE .750 X .560 X 2.180
2	FTLUBE	URETHANE LUBE

	FT20589	HARDWARE KIT
2	1/2-20 C-LOCK NUT ZINC	Control Arm
2	1/2 SAE WASHER G5 ZINC	-----
2	3/4-16 C-LOCK NUT ZINC	-----
2	M12-1.75 X 70MM HEX BOLT G10.9	Driver side diff mount
2	1/4-20 X 1 HEX BOLT G5 ZINC	Brake line to control arm
4	1/4 SAE WASHER G5 ZINC	-----
2	1/4-20 NYLOCK NUT ZINC	-----
2	3/8-16 X 3/4 HEX SELF TAP ZINC	Skid plate
8	5/16-18 X 1 HEX BOLT G8 ZINC	Ball joint to control arm
16	5/16 SAE WASHER G5 ZINC	-----
8	5/16-18 C-LOCK NUT ZINC	-----
4	7/16-14 X 2-1/4 HEX BOLT G8 ZC	Shock to control arm
20	7/16 SAE WASHER G5 ZINC	-----
6	7/16 NYLOCK NUT ZINC	-----
4	7/16-14 C-LOCK NUT ZINC	Coil spacer
2	1/2-13 X 4 HEX BOLT G8 ZINC	Passenger side diff mount
4	1/2 SAE WASHER G8 ZINC	-----
2	1/2-13 C-LOCK NUT ZINC	-----
4	CLAMP 3/8X1/2W	Brake Line
1	THREAD LOCKING COMPOUND 1 MIL	-----
6	8" ZIP TIE	Brake Line
4	ZERK FITTING	Control arm

- PRE-INSTALLATION NOTES -

For technical assistance call: **909-597-7800** or e-mail: **info@fabtechmotorsports.com**

Read This Before You Begin Installation:

- WILL NOT WORK WITH FACTORY STEEL SUSPENSIONS
- Check all parts to the parts list above before beginning installation. If any parts are missing contact Fabtech at 909-597-7800 and a replacement part will be sent to you immediately.
- Read all instructions thoroughly from start to finish before beginning the installation. If these instructions are not properly followed severe frame, driveline and / or suspension damage may occur.
- Check your local city and state laws prior to the installation of this system for legality. Do not install if not legal in your area.
- Prior to the installation of this suspension system perform a front end alignment and record. Do not install this system if the vehicle alignment is not within factory specifications. Check for frame and suspension damage prior to installation.
- The installation of this suspension system should be performed by two professional mechanics.
- Installation of all fasteners requires the use of provided thread locking compound with proper torque values as indicated throughout the installation. Apply thread locking compound upon the final torque of the fastener.
- WARNING - Installation of this system will alter the center of gravity of the vehicle and may increase roll over as compared to stock.
- Vehicles that receive oversized tires should check ball joints, uniballs, tie rods ends, pitman arm and idler arm every 2500 5000 miles for wear and replace as needed.
- Verify differential fluid is at manufactures recommended level prior to kit installation. Installation of the kit will reposition the differential and the fill plug hole may be in a different position. (For example, if the manufacture recommends 3 quarts of fluid, make sure the diff has 3 quarts of fluid). Check your specific manual for correct amount of fluid.

Footnotes:

- OEM Wheels and tires cannot be used after the installation of this kit. Larger tire cannot be installed on the OEM wheels.
- Requires cutting of fenderwell sheetmetal for use with 33" tires.
- Suspension system will not work on vehicles equipped with factory auto ride suspension.

Recommend Tires and Wheels:

Use 295/70R17 tire w/ 17x8 wheels w/ 4-1/2" BS w/ minor trimming

Use 275/65R18 tire w/ 18x8 wheels w/ 4-1/2" BS w/ minor trimming

Use 285/55R20 tire w/ 20x9 wheels w/ 5" BS w/ minor trimming

- TOOL LIST -

Required Tools (Not Included)

Basic Hand Tools

Floor Jack

Jack Stands

Assorted Metric and S.A.E sockets, and Allen wrenches

Torque Wrench

Die Grinder w/ Cut Off Wheel

- INSTRUCTIONS -

FRONT SUSPENSION

1. Disconnect the negative terminal on the battery. Jack up the front end of the truck and support the frame rails with jack stands. **NEVER WORK UNDER AN UNSUPPORTED VEHICLE!** Remove the front tires.
2. Starting on the driver side of the truck, remove the bolt attaching the brake line tab to the spindle.
3. Follow the wheel speed sensor wire from frame rail plug. Separate the wire from the upper control arm. **SEE FIGURE 1**

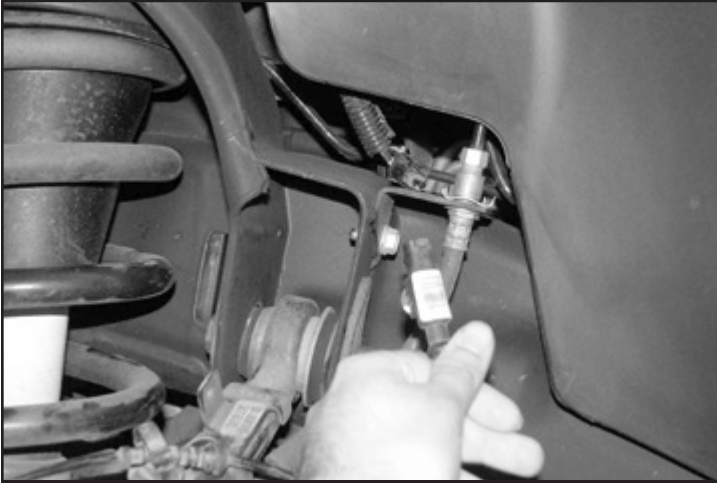

FIGURE 1

4. Remove the nuts securing the tie rod and upper arm ball joints to the spindle. Separate both joints from the spindle by striking the knuckle with a large hammer next to each joint on the knuckle to dislodge. **SEE FIGURE 2**

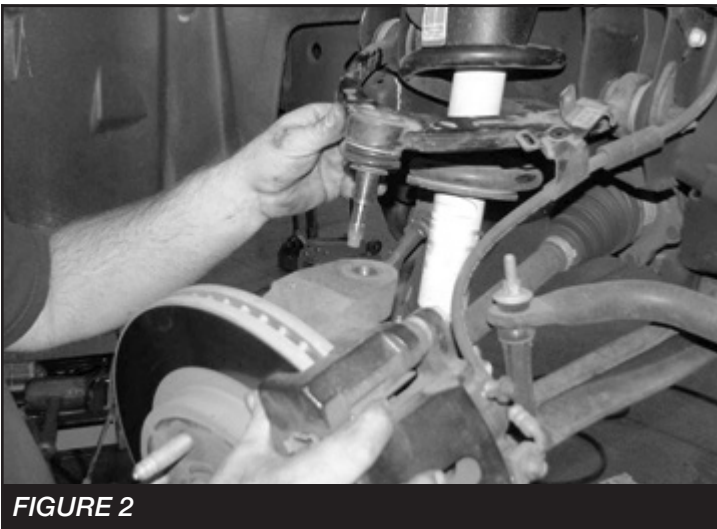

FIGURE 2

5. Remove the factory coil over and save.

6. Mark the location of the alignment cams on the frame of the upper control arm pocket. Remove the upper control arm from the vehicle and save the factory hardware. **SEE FIGURE 3**

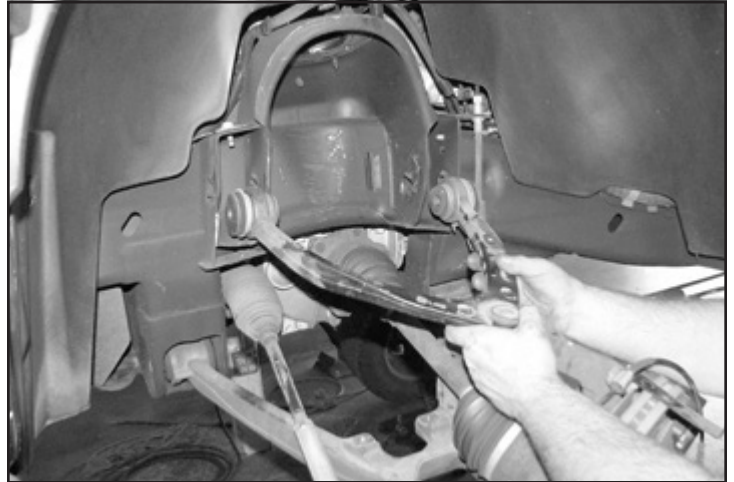

FIGURE 3

7. Remove the factory CV shaft from the differential drive flange. Retain Hardware. **SEE FIGURE 4**



FIGURE 4

8. Using a die grinder remove the factory droop stop off the control arm pocket. **SEE FIGURES 5-6**

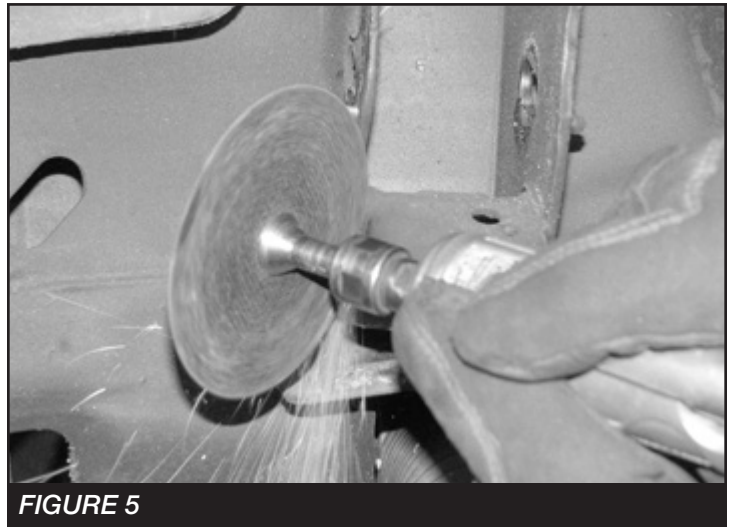

FIGURE 5

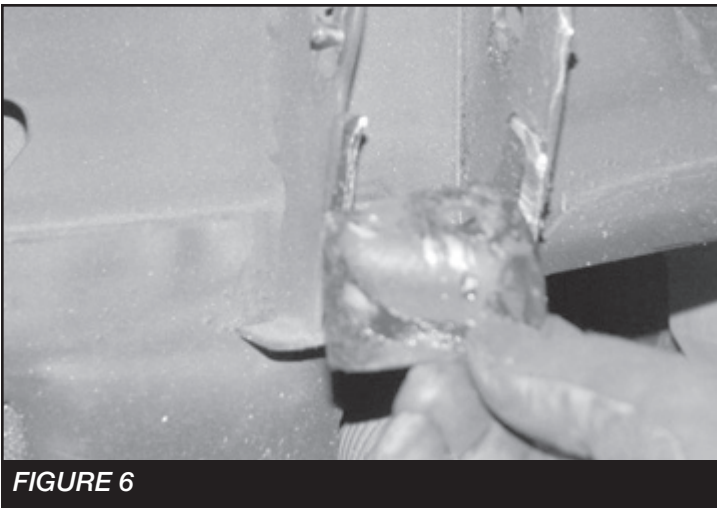

FIGURE 6

9. Using a die grinder, partially cut the brake line bracket. This will allow the bracket to be bent and removed from the brake line. Be careful not to damage brake hose.

- Repeat steps 2-9 on passenger side.

10. Remove the factory rear cross member and retain factory hardware. **SEE FIGURE 7**

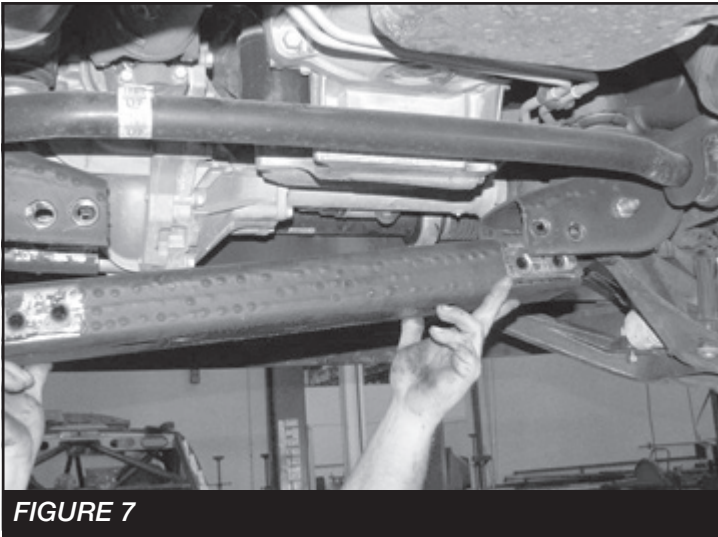

FIGURE 7

11. Due to vehicle variances, the steering will need to be removed and trimmed on the driver side where the wiring harnesses are located. **SEE FIGURE 8**

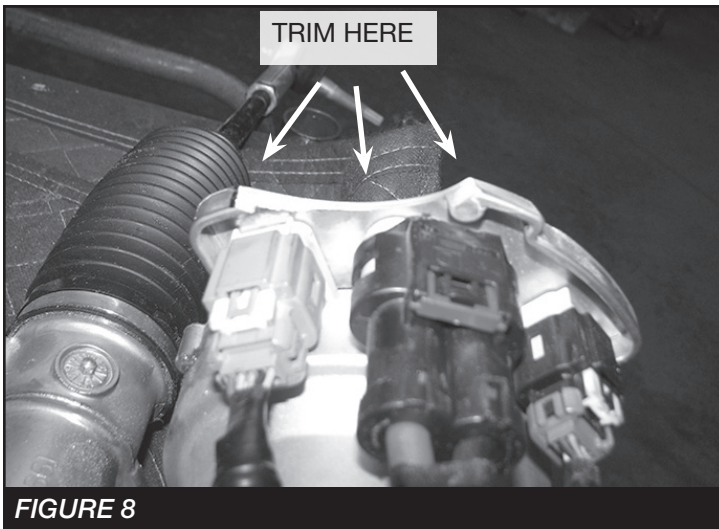

FIGURE 8

12. Disconnect the drive shaft from the front differential solenoid wiring. Disconnect the differential vent tube and remove the diff. Retain Hardware. **SEE FIGURE 9**

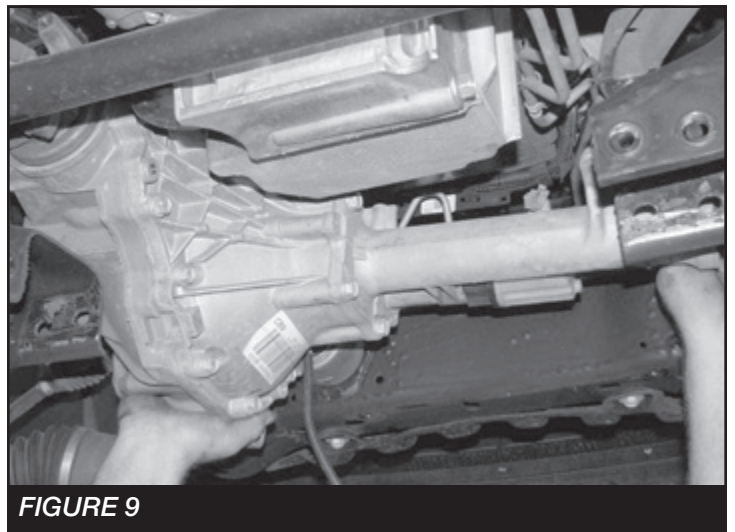

FIGURE 9

13. Locate the factory passenger side diff mount and remove. Retain Hardware. **SEE FIGURE 10**

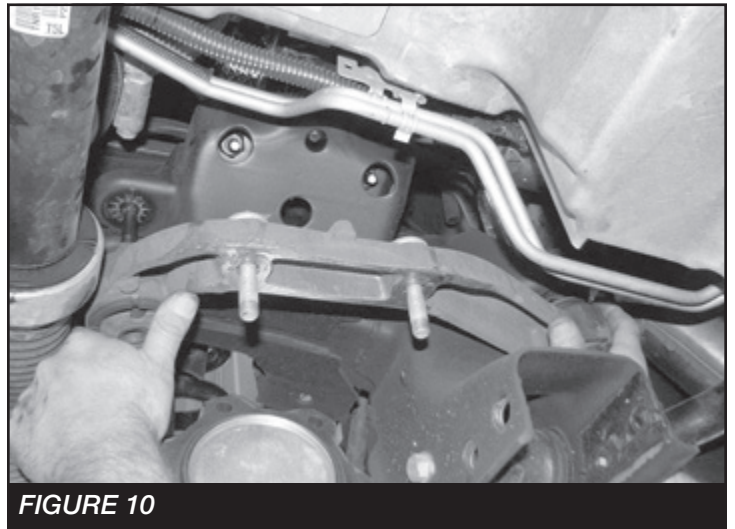

FIGURE 10

14. Remove the factory studs from the differential mount and discard. **SEE FIGURE 11**

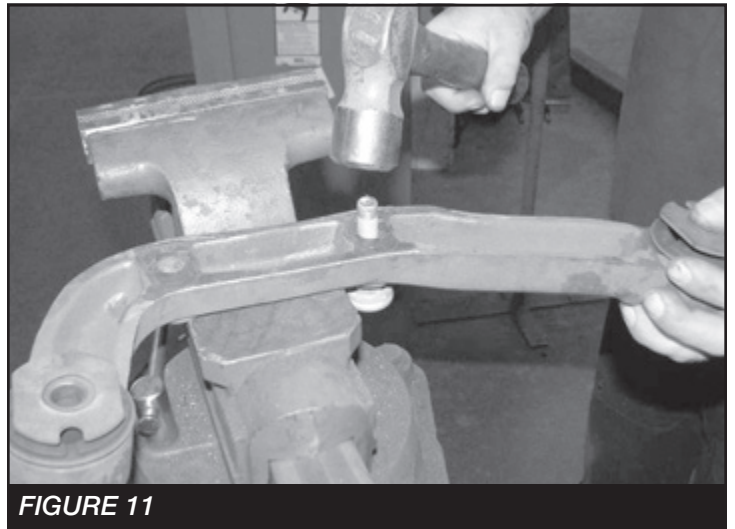

FIGURE 11

15. Locate the factory diff and cut off the driver side rear cooling fins. **SEE FIGURES 12-13**

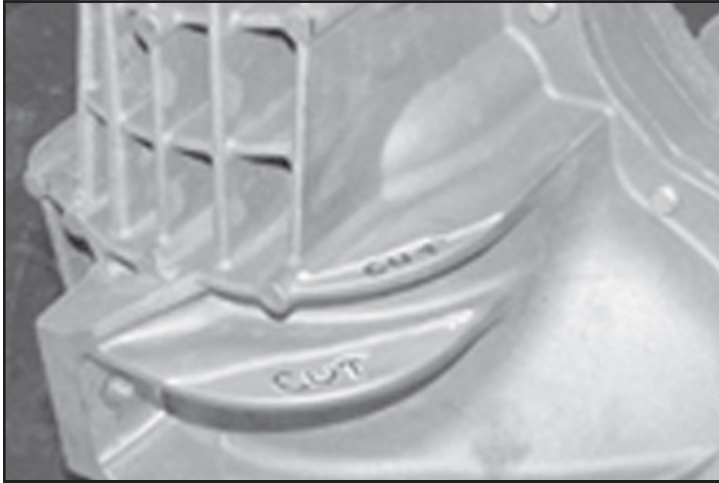

FIGURE 12



FIGURE 13

16. Locate the factory rear driver lower control arm pocket / cross member mount. Using a die grinder remove the material shown in the diagram below. **SEE FIGURES 14-15**

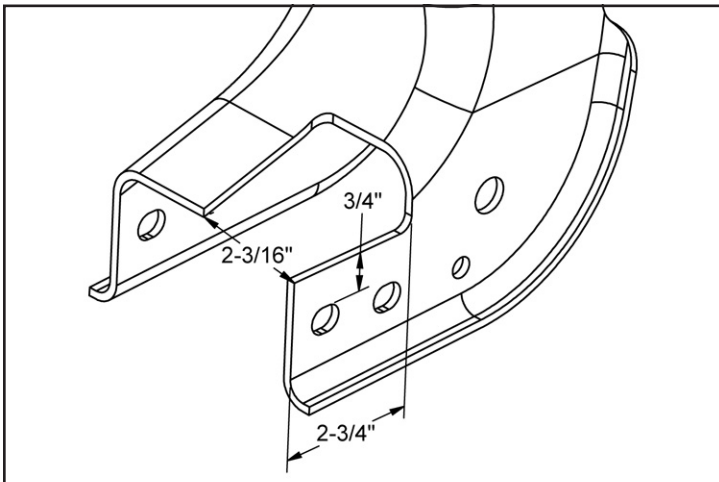

FIGURE 14

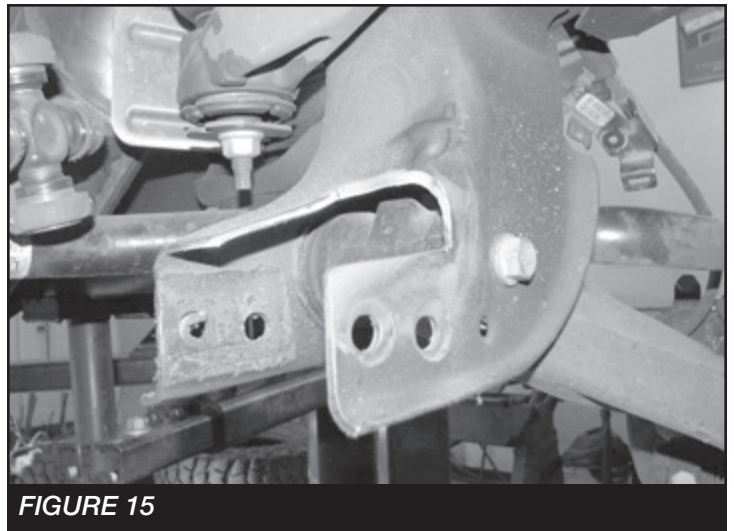

FIGURE 15

17. Locate the factory driver side Diff mount. Using a die grinder remove the locating pin from the mount. **SEE FIGURES 16-17**

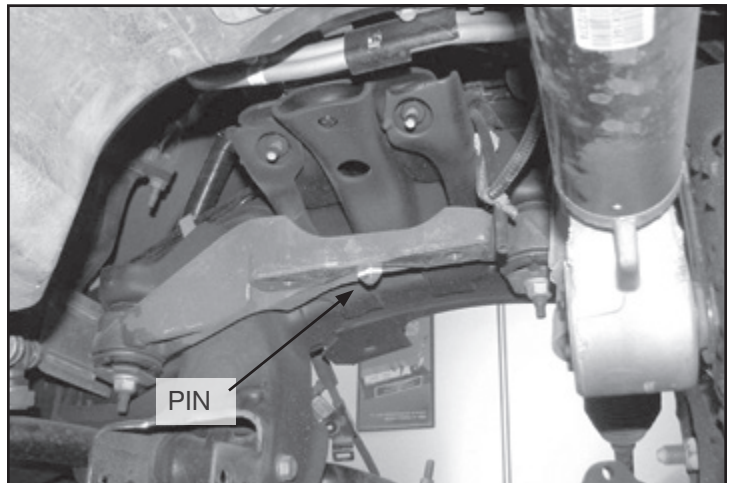

FIGURE 16

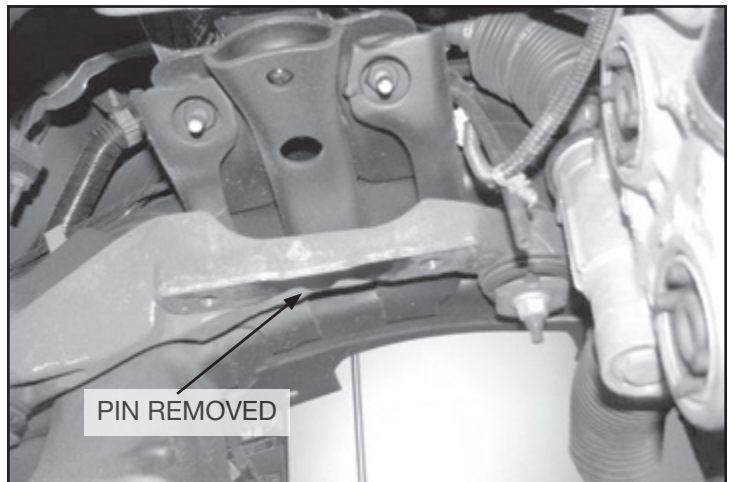

FIGURE 17

18. Locate the FT20625 driver side diff mount and the FT20626 passenger side diff mount. Starting on the driver side, remount the diff with two M12-1.75 x 70mm bolts. **SEE FIGURE 18**

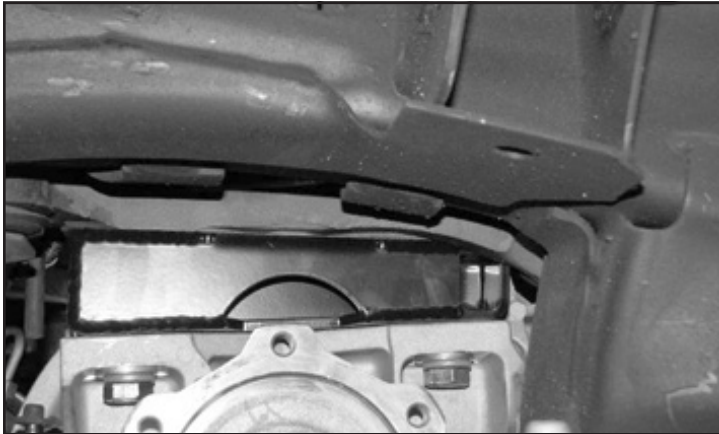

FIGURE 18

19. Using the passenger side differential mount, two 1/2"-13 x 4" bolts, nuts and washers, mount the passenger side of the differential. **NOTE: Run the bolts from the bottom up.** Torque the 1/2" bolts to 127 ft-lbs and the 12mm bolts to 100 ft-lbs. **SEE FIGURE 19**



FIGURE 19

20. Locate the factory rear cross member. Using a die grinder remove the material from the driver side. **SEE FIGURES 20-21**

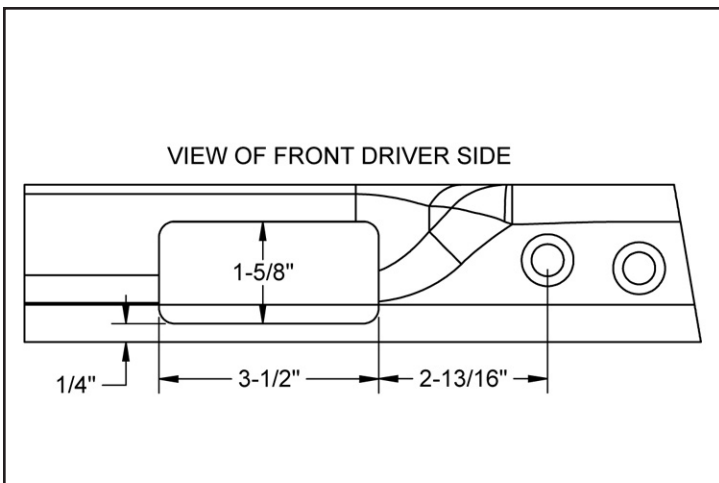

FIGURE 20

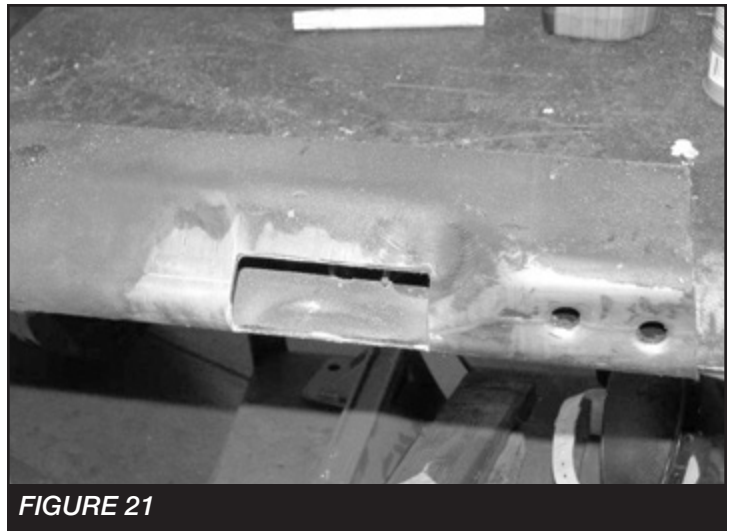

FIGURE 21

21. Reconnect the drive shaft, differential vent tube and solenoid with factory hardware. Torque to 17 ft-lbs.
22. Cut the front of the differential to clear the new skid plate. **SEE FIGURES 22-23**



FIGURE 22

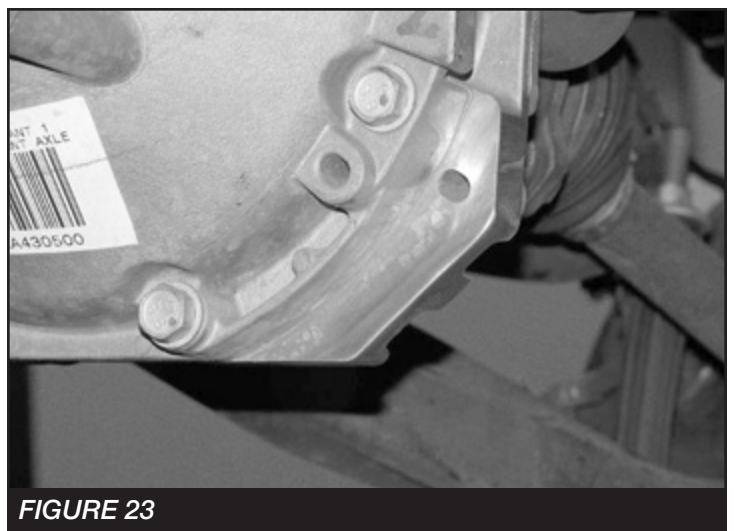

FIGURE 23

23. Locate the FT20627BK skid plate and the two 3/8" - 16x3/4" self tapping bolts. Mount the skid plate to the factory front cross member using two of the factory front bolts. With front of the skid plate mounted, use the back two holes in the skid plate for a drill guide. Drill two 5/16" pilot holes and install the two 3/8" self tapping bolts. Torque to 21 ft-lbs. Be careful not to over torque.

SEE FIGURE 24

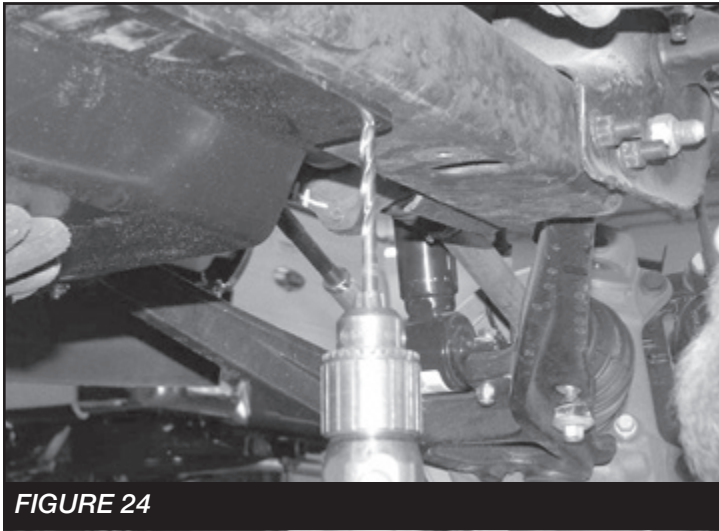

FIGURE 24

24. Locate the Fabtech driver's side control arm FT20585BK, two FT1002 bushings, two FTS1001 bushings, two grease zerks FT84, and two sleeves FT1500-6-101.

25. Install all these components in the control arm barrels.

SEE FIGURE 25

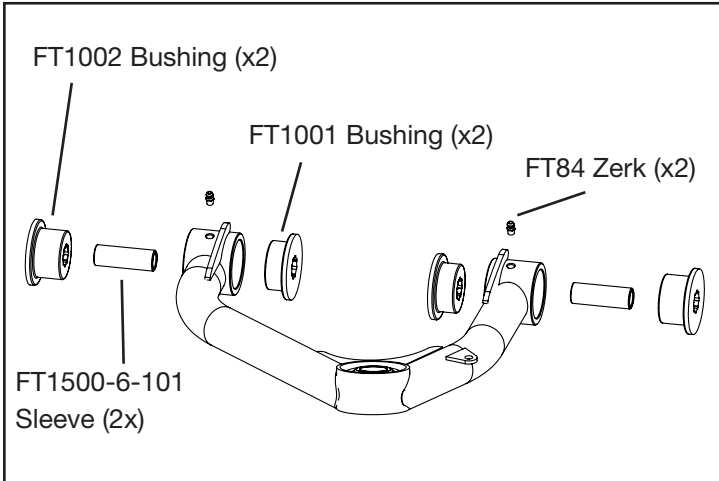

FIGURE 25

26. Install the new Fabtech upper control arm in the factory upper control arm pockets using the factory hardware at the previously marked alignment cam location. When installing the arm on the truck, make sure the barrel gussets are facing up. Torque to 160 ft-lbs.

SEE FIGURE 26

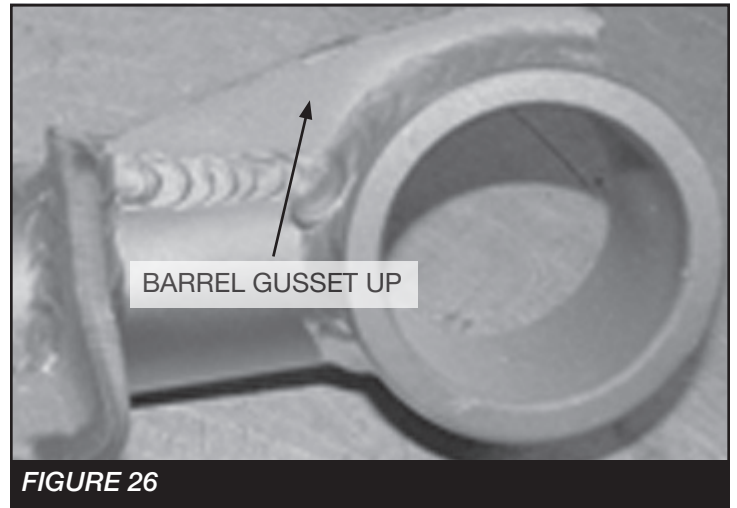

FIGURE 26

27. If installing Dirt Logic coilover, FTS825282 or FT820282D & P, do so at this time using hardware provided with that shock. **NOTE: See Figure 27 for resi mount orientation.** Otherwise, continue with Step 29 with the factory shock.

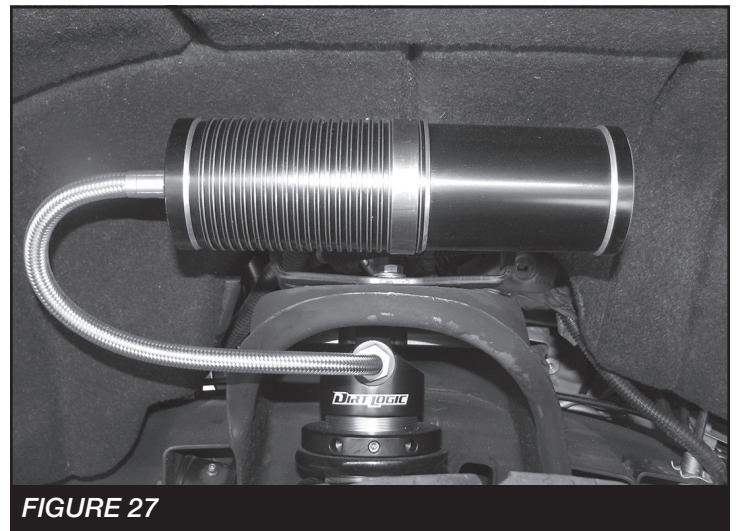

FIGURE 27

28. Locate the factory coil over and remove the sheet metal nut from the lower bar pin.

29. Cut a 1/4" off the studs on the top side of the coil over.
SEE FIGURES 28-29

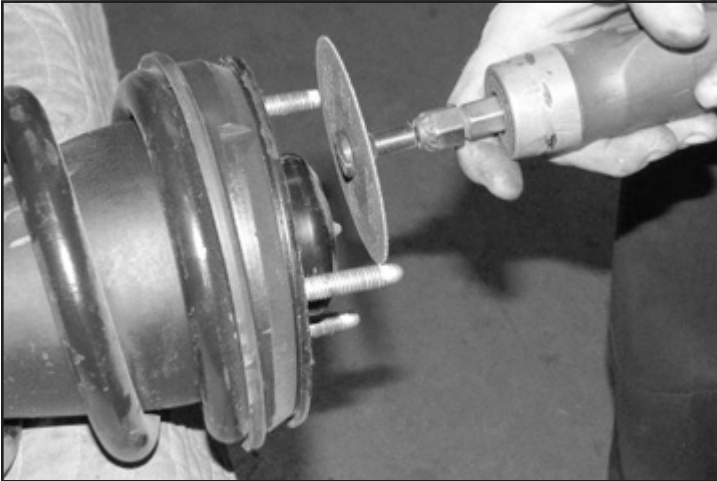

FIGURE 28



FIGURE 29

30. Install the FT20801 coil spacer using the factory nuts and torque to 58 ft-lbs. **SEE FIGURE 30**

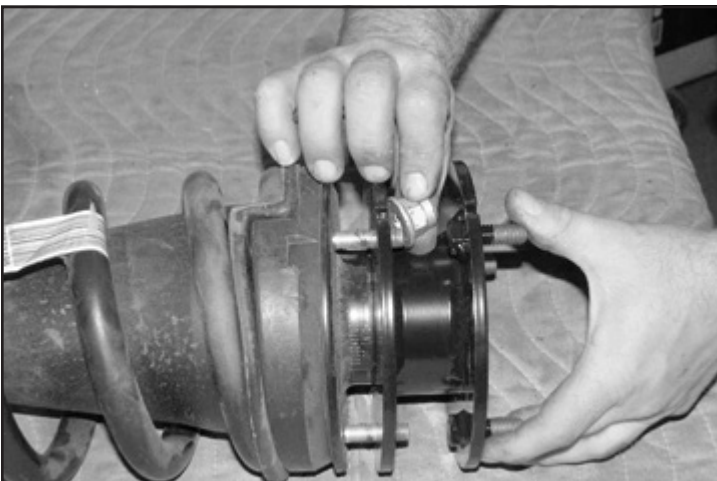

FIGURE 30

31. Locate the three 7/16" nylock nuts and install the coil over into the upper shock mount. Leave loose at this time.
SEE FIGURE 31

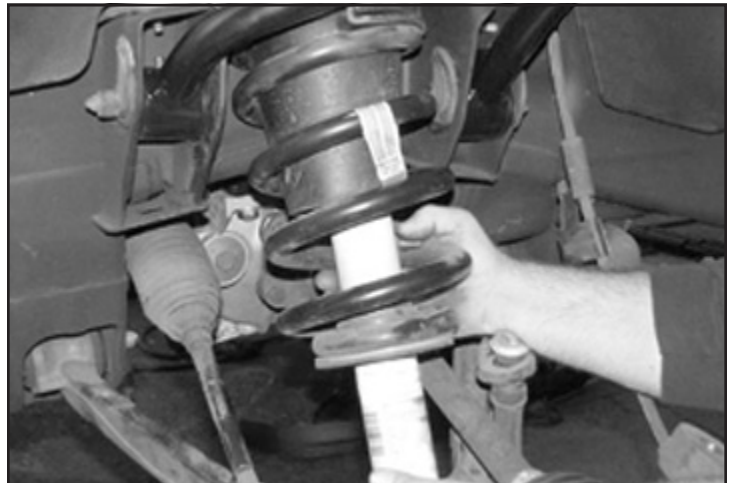

FIGURE 31

32. Locate the two 7/16"-14 x 2-1/4" bolts, nuts and washers and install the lower bar pin mount onto the lower control arm. Torque the upper and lower bolts to 83 ft-lbs.
SEE FIGURE 32



FIGURE 32

33. Locate FT94503 Uniball adapter pin, and two FT147 uniball misalignment spacers.

SEE FIGURE 33 FOR STEPS 34 - 38

34. Insert the uniball pin into the factory knuckle upper ball joint taper. Install the 1/2 -20 lock nut with thread lock compound and flat washer onto the bottom side of the pin. This will lock the pin into the knuckle. Torque to 127 ft-lbs.
35. Install one FT147 uniball misalignment spacer on to the pin.
36. Swing the control arm down, slide the pin into the uniball on the control arm seating the lower FT147 spacer in the control arm.
37. Install the upper FT147 uniball misalignment spacer onto the pin.

38. Install the 3/4" -16 lock nut on the top side of the pin with thread lock compound and torque to 150 ft-lbs.

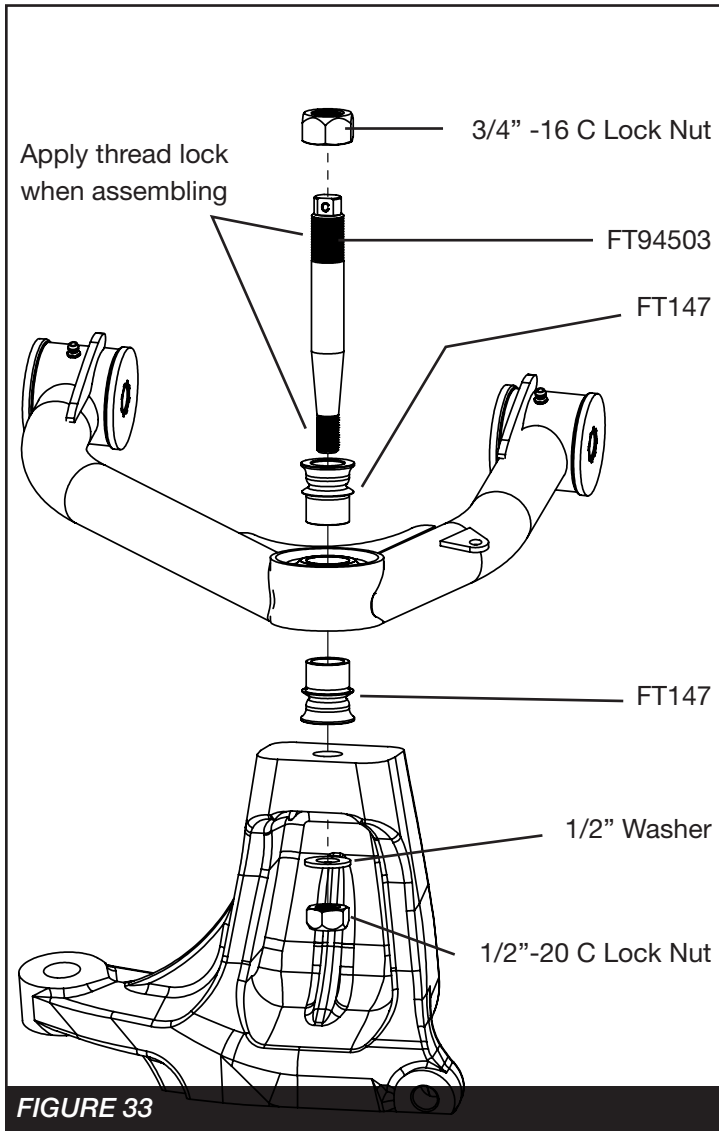

FIGURE 33

39. Reinstall the CV shaft and torque to 58 ft-lbs.
 40. Locate Factory brakeline and wheel speed sensor wire.
 41. Install the FTCLAMP on top of the spindle to hold the wheel speed sensor wire. **SEE FIGURE 34**



FIGURE 34

42. Attach the brakeline to the small tab on the control arm using the FTCLAMP, 1/4"-20 x 1" bolts, nuts and washers. **SEE FIGURE 35**

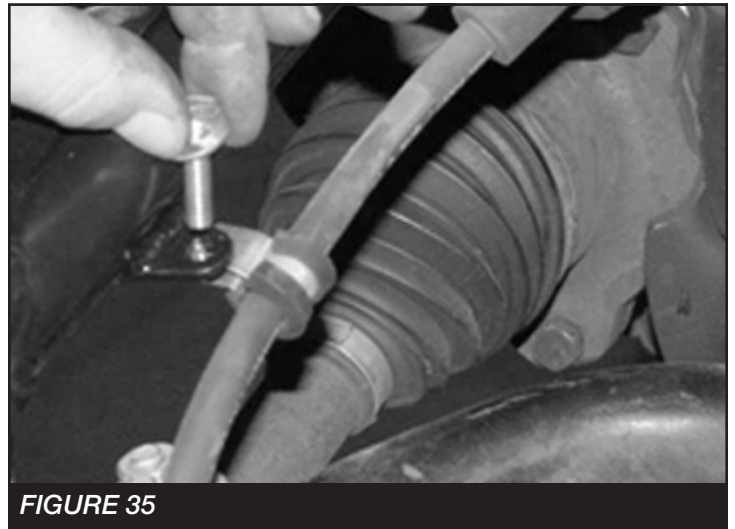

FIGURE 35

43. Reconnect the wheel speed sensor and zip tie to the brake line. **SEE FIGURE 36**

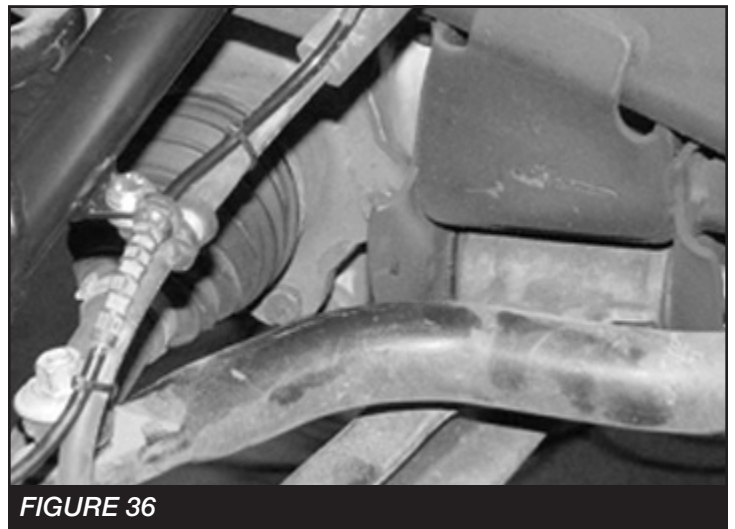

FIGURE 36

44. Repeat steps 25-44 on the passenger side of the vehicle where applicable.

REAR SUSPENSION

45. Locate the FTBK15 blocks and the four FT1500U u-bolts. With the stock u-bolts removed and the rear axle clear of the leaf spring, make sure the block will fully seat onto the leaf spring and the spring pad of the rear axle housing with the wide end of the block to the rear of the vehicle. On the leaf spring make sure the center pin head will seat fully into the hole in of the block allowing the top surface of the block to rest against the leaf spring. Install the new u-bolts with washers and nuts from the FT916H hardware kit and torque to 184 ft-lbs. **Note – The Vehicle's stance will be level with the Fabtech block. To achieve a higher rear stance stack both factory and Fabtech blocks. NOTE: For FTS21157 install FTBK3 (3" Block).**

46. Install rear shocks using FTS7333 Performance shocks, FTS6333 Stealth Shocks or FTS810152 Dirt Logic shocks with factory hardware. Torque to 100 ft-lbs.
47. Install tires and wheels and torque lug nuts to wheel manufacturer's specifications. Turn front tires left to right and check for appropriate tire clearance. **Note - Some oversized tires may require trimming of the front bumper & valance.**
48. Check front end alignment and set to factory specifications. Readjust headlights.
49. Recheck all bolts for proper torque.
50. Recheck brake hoses, ABS wires and suspension parts for proper tire clearance while turning tires fully left to right.
51. Check the fluid in the front and rear differential and fill if needed with factory specification differential oil. **Note - some differentials may expel fluid after filling and driving. This can be normal in resetting the fluid level with the new position of the differential/s.**
52. Install Driver Warning Decal. Complete product registration card and mail to Fabtech in order to receive future safety and technical bulletins on this suspension.

Vehicles that will receive oversized tires should check ball joints, uniballs and all steering components every 2500-5000 miles for wear and replace as required.

**RETORQUE ALL NUTS, BOLTS AND LUGS
AFTER 50 MILES AND PERIODICALLY
THEREAFTER.**

For technical assistance call: **909-597-7800**

- Product Warranty and Warnings -

Fabtech provides a Limited Lifetime Warranty to the original retail purchaser who owns the vehicle, on which the product was originally installed, for defects in workmanship and materials.

The Limited Lifetime Warranty excludes the following Fabtech items; bushings, bump stops, ball joints, tie rod ends, limiting straps, cross shafts, heim joints and driveshafts. These parts are subject to wear and are not considered defective when worn. They are warranted for 60 days from the date of purchase for defects in workmanship.

Dirt Logic and Performance Coilover take apart shocks are considered a serviceable shock with a one year warranty on leakage only. Service seal kits are available separately for future maintenance. All other shocks are covered under our Limited Lifetime Warranty.

Fabtech does not warrant any product for finish, alterations, modifications and/or installation contrary to Fabtech's instructions. Alterations to the finish of the parts including but not limited to painting, powder coating, plating and/or welding will void all warranties. Some finish damage may occur to parts during shipping, which is considered normal and is not covered under warranty.

Fabtech products are not designed nor intended to be installed on vehicles used in race applications or for racing purposes or for similar activities. (A "RACE" is defined as any contest between two or more vehicles, or any contest of one or more vehicle against the clock, whether or not such contest is for a prize). This warranty does not include coverage for police or taxi vehicles, race vehicles, or vehicles used for government or commercial purposes. Also excluded from this warranty are sales outside of the United States of America.

Installation of most suspension products will raise the center of gravity of the vehicle and will cause the vehicle to handle differently than stock. It may increase the vehicle's susceptibility to a rollover, on road and off road, at all speeds. Extreme care should be taken to operate the vehicle safely at all times to prevent rollover or loss of control resulting in serious injury or death. Fabtech front end Desert Guards may impair the deployment or operation of vehicles equipped with supplemental restraining systems/air bag systems and should not be installed if the vehicle is equipped as so.

Fabtech makes every effort to ensure suspension product compatibility with all vehicles listed on the website, but due to unknown auto manufacturer's production changes and/or inconsistencies by the auto manufacturer, Fabtech cannot be responsible for 100% compatibility, including the fitment of tire and wheel sizes listed. The Tire and Wheel sizes listed in Fabtech's website are only a guideline for street driving with noted fender trimming. Fabtech is not responsible for damages to the vehicle's body or tires. Fabtech is not responsible for premature wear of factory components due to the installation of oversized tires and wheels.

Fabtech's obligation under this warranty is limited to the repair or replacement, at Fabtech option, of the defective product only. All costs of removal, installation or re-installation, freight charges, incidental or consequential damages are expressly excluded from this warranty. Fabtech is not responsible for damages and/or warranty of other vehicle parts related or non related to the installed Fabtech product. This warranty is expressly in lieu of all other warranties expressed or implied. This warranty shall not apply to any product that has been subject to accident, negligence, alteration, abuse or misuse as determined by Fabtech.

Fabtech suspension components must be installed as a complete system including shocks as shown on our website. All warranties will become void if Fabtech parts are combined and/or substituted with other aftermarket suspension products. Combination and/or substitution of other aftermarket suspension parts may cause premature wear and/or product failure resulting in an accident causing injury or death. Fabtech does not warrant products not manufactured by Fabtech.

Depending on the condition of the factory suspension components retained after the installation of a Fabtech suspension not all vehicles may have the same ride stance front to rear as described in the website. The blue color of suspension components shown in all Fabtech photographs are for display purposes only. Majority of all Fabtech components will be black specifically where noted with part numbers ending in BK.

Installation of Fabtech product may void the vehicles factory warranty; it is the consumer's responsibility to check with their local vehicle's dealer for warranty disposition before the installation of the product. Some state laws may prohibit modification of suspension to a vehicle in whole or in part. It is the responsibility of the installer and consumer to consult local laws prior to the installation of any Fabtech suspension product to comply with such written laws.

It is the responsibility of the distributor and/or the retailer to review all warranties and warnings of Fabtech products with the consumer prior to purchase.

Fabtech reserves the right to super cede, discontinue, change the design, finish, part number and/or application of parts when deemed necessary without written notice. Fabtech is not responsible for misprints or typographical errors within the website or price sheet. For the most recent Product Warranty and Warnings visit our website www.fabtechmotorsports.com