



## FORD 2021 - 2023 F-150 3" Suspension Kit

Thank you for choosing Rough Country for all your suspension needs.

Rough Country recommends a certified technician install this system. In addition to these instructions, professional knowledge of disassembly/reassembly procedures as well as post installation checks must be known. Attempts to install this system without this knowledge and expertise may jeopardize the integrity and/or operating safety of the vehicle.

**▲ NOTICE** Please read instructions before beginning installation. Check the kit hardware against the parts list on the next page. Be sure you have all needed parts and know where they go. Also, please review tools needed list and make sure you have the needed tools.

### PRODUCT USE INFORMATION

**▲ WARNING** As a general rule, the taller a vehicle is, the easier it will roll. Seat belts and shoulder harnesses should be worn at all times. Avoid situations where a side rollover may occur. Generally, braking performance and capability are decreased when larger/heavier tires and wheels are used. Take this into consideration while driving. Do not add, alter, or fabricate any factory or after-market parts to increase vehicle height over the intended height of the Rough Country product purchased. Mixing component brands is not recommended. Rough Country makes no claims regarding lifting devices and excludes any and all implied claims. We will not be responsible for any product that is altered. If questions exist we will be happy to answer any questions concerning the design, function, and correct use of our products.

This suspension system was developed using a 34" or 295/70R18-295/60R20, tire on 9" wheels with a +12 offset. Factory wheels and tires can be used. If using a larger tire on the factory wheel, wheel spacers are required. **Note** if wider tires are used, offset wheels will be required and trimming will be required.

**▲ WARNING** This vehicle will require the EPAS (Electronic Power Assist Steering) plugs to be disconnected prior to beginning installation of this kit. See installation instructions. Failure to disconnect these plugs may result in damage to the EPAS module resulting in an error message being displayed, which will require replacement of the EPAS module.

### DEALER AND VEHICLE OWNER

**▲ NOTICE** Any vehicle equipped with any Rough Country product should have a "Warning to Driver" decal installed on the inside of the windshield or on the vehicle's dash. The decal should act as a constant reminder for whoever is operating the vehicle of its unique handling characteristics.

INSTALLING DEALER - it is your responsibility to install the warning decal and forward these installation instructions on to the vehicle owner for review. These instructions should be kept in the vehicle for its service life.

**▲ NOTICE** Note to installer : Before installation begins we recommend that a test drive be performed. While driving check for uncommon sounds and/or vibrations . What you feel and hear during the test drive will only magnify once lift kit is installed. Advise you to discuss possible issues identified from drive with customer before proceeding to install this kit.



**Kit Contents: 41430**

**41400BAG1**  
**569BAG1 x1**  
**N3 Rear Shock (660771) x2**  
**1" Rear Block x2**  
**Dr. Upper Control Arm x1**  
**Pass. Upper Control Arm x1**  
**9/16 Bag x1**  
**U-bolts x4**  
**10mm Studbag-2 x1**  
**Strut Spacer Side (A) x2**  
**Preload Spacer x4**  
**RCK6696P2BAG x2**

**41400BAG1:** For upper control arm  
Headlight Sensor Bracket x2  
6mm x 14mm Bolts x4  
6mm Lock Nut x2

**9/16 Bag:** For U-bolts.  
9/16 Flat Washers x8  
9/16-18 Nylock Nut x8

**10mm STUDBAG-2:** For upper strut spacers.  
1/2-20 Jam Nut x1  
10mm-1.25 Hex Nut x1  
10mm-1.25 Strut Spacer Stud x6  
10mm-1.25 Serrated Flange Nut x6

**RCK6696P2BAG**  
Ball Joint Hardware Bag

**Kit Contents: 41431**

**41400BAG1**  
**3" N3 Loaded Strut x2**  
**N3 Rear Shock (660771) x2**  
**1" Rear Block x2**  
**Dr. Upper Control Arm x1**  
**Pass. Upper Control Arm x1**  
**9/16 Bag x1**  
**U-bolts x4**  
**RCK6696P2BAG x2**

**9/16 Bag:** For U-bolts.  
9/16 Flat Washers x8  
9/16-18 Nylock Nut x8

**RCK6696P2BAG**  
Ball Joint Hardware Bag

**41400BAG1:** For upper control arm  
Headlight Sensor Bracket x2  
6mm x 14mm Bolts x4  
6mm Lock Nut x2

**Kit Contents: 41450**

**41400BAG1**  
**Dr. Vertex 3" Coilover x1**  
**Pass. Vertex 3" Coilover x1**  
**Rear Vertex 2" Shock x2**  
**1" Rear Block x2**  
**Dr. Upper Control Arm x1**  
**Pass. Upper Control Arm x1**  
**9/16 Bag x1**  
**U-bolts x4**  
**RCK6696P2BAG x2**

**9/16 Bag:** For U-bolts.  
9/16 Flat Washers x8  
9/16-18 Nylock Nut x8

**RCK6696P2BAG**  
Ball Joint Hardware Bag

**41400BAG1:** For upper control arm  
Headlight Sensor Bracket x2  
6mm x 14mm Bolts x4  
6mm Lock Nut x2

**Kit Contents: 41457**

**41400BAG1**  
**Dr. Vertex 3" Coilover x1**  
**Pass. Vertex 3" Coilover x1**  
**Rear V2 Monotube Shock x2**  
**1" Rear Block x2**  
**Dr. Upper Control Arm x1**  
**Pass. Upper Control Arm x1**  
**9/16 Bag x1**  
**U-bolts x4**  
**RCK6696P2BAG x2**

**9/16 Bag:** For U-bolts.  
9/16 Flat Washers x8  
9/16-18 Nylock Nut x8

**RCK6696P2BAG**  
Ball Joint Hardware Bag

**41400BAG1:** For upper control arm  
Headlight Sensor Bracket x2  
6mm x 14mm Bolts x4  
6mm Lock Nut x2





**Torque Specs:**

Size	Grade 5	Grade 8	Size	Class 8.8	Class 10.9
5/16"	15 ft/lbs	20ft/lbs	6MM	5ft/lbs	9ft/lbs
3/8"	30 ft/lbs	35ft/lbs	8MM	18ft/lbs	23ft/lbs
7/16"	45 ft/lbs	60ft/lbs	10MM	32ft/lbs	45ft/lbs
1/2"	65 ft/lbs	90ft/lbs	12MM	55ft/lbs	75ft/lbs
9/16"	95 ft/lbs	130ft/lbs	14MM	85ft/lbs	120ft/lbs
5/8"	135ft/lbs	175ft/lbs	16MM	130ft/lbs	165ft/lbs
3/4"	185ft/lbs	280ft/lbs	18MM	170ft/lbs	240ft/lbs



## INSTALLATION INSTRUCTONS

1. Jack up the front of the vehicle and support the vehicle with jack stands, so that the front wheels are off the ground. Next, remove the front tires/wheels, using a 21mm deep well socket.
2. Using a 15mm socket remove the front skid, if the truck is equipped with a full front skid.
3. Disconnect the EPAS (Electronic Power Assist Steering) Plugs as shown located on the steering assembly by the front differential. **See Photo 1 & 2. This must be done BEFORE installation is started.**

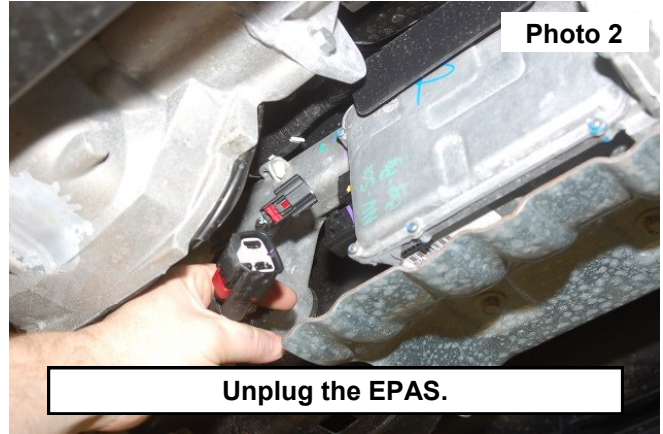
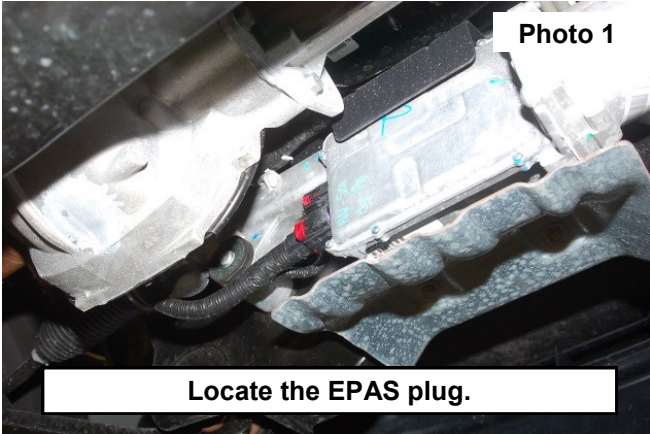

4. Using a 21mm wrench remove the nut from the tie rod on the knuckle. Using a tie rod/ball joint puller, remove the tie rod from the knuckle. Push linkage forward to make room for installation. Retain factory hardware. **See Photo 3.**
5. Using a 8mm socket remove the ABS bracket from the knuckle and also remove the brake line bracket with a 10mm socket. **See Photo 4.**

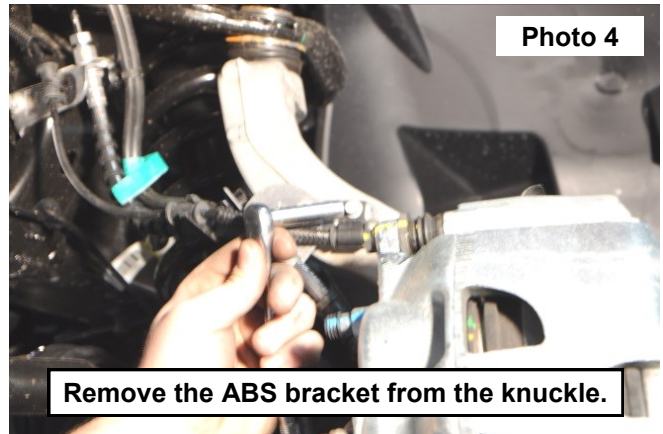
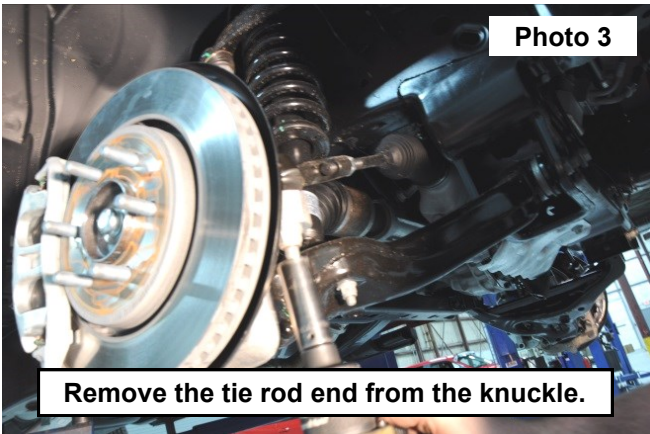

6. Next remove the caliper bolts with a 18mm socket as shown in **Photo 5** and the dust shield bolts with a 8mm socket. Remove the ABS wire from the knuckle with a 5mm Allen wrench.
7. Use a pair of pliers to pull off the axle dust cap and remove the axle nut with a 15mm socket. **See Photo 6.**

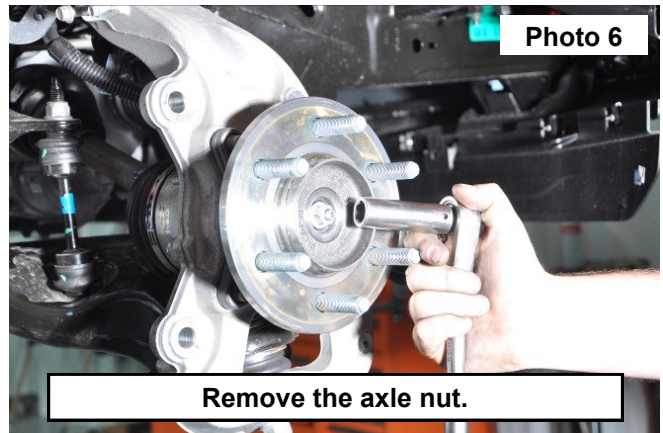
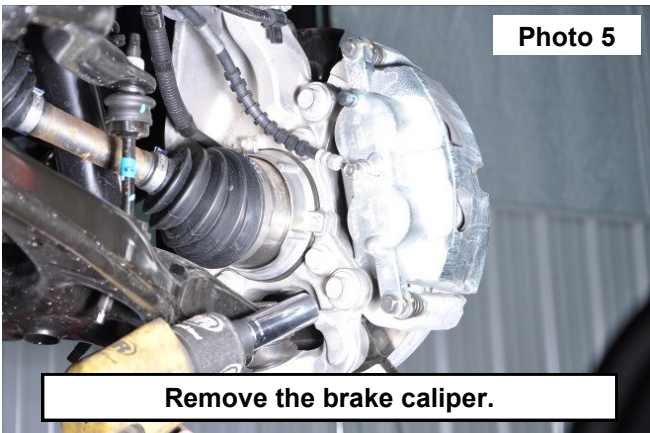

8. Using a 21mm wrench and a 1 1/16" socket loosen the lower control arm bolts. Do not remove the bolts just loosen them so you can later swing the lower control arm down.
9. Remove the sway bar nut from the knuckle using a 18mm socket. Retain factory hardware. **See Photo 7.**
10. Place jack stand under the lower control arm for support. Loosen the upper ball joint nut using a 18mm wrench. Unseat the upper ball joint taper from the knuckle using a hammer, striking the knuckle. Then remove the upper ball joint nut and remove the upper ball joint from the knuckle. **See Photo 8.**
11. Do not allow the knuckle to pull out far enough that it pulls the shaft out of the differential.

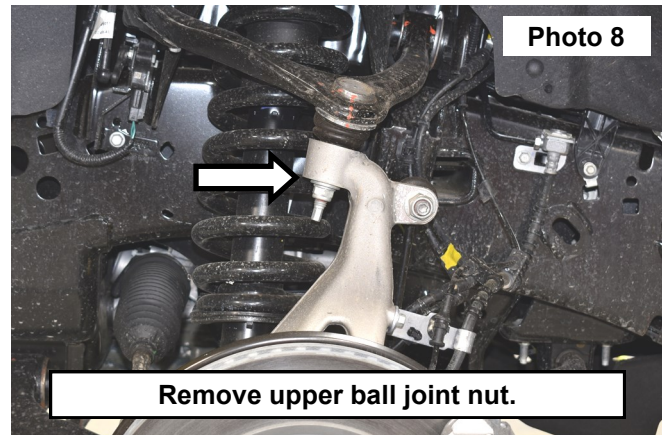
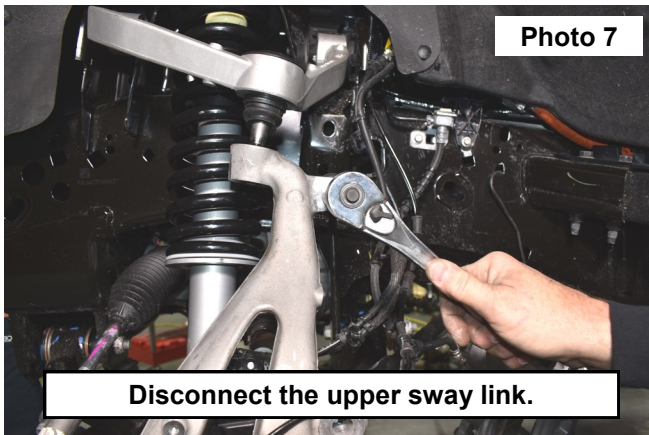

12. Remove the lower strut nuts using a 18mm socket for 21 models. **See Photo 9.** Retain hardware for reuse.
13. Using a 18mm wrench, remove the nuts on the upper strut tower that holds the assembly in place. **See Photo 10.**
14. Lower the jack to let the lower control arm and knuckle swing down so the strut can be removed.

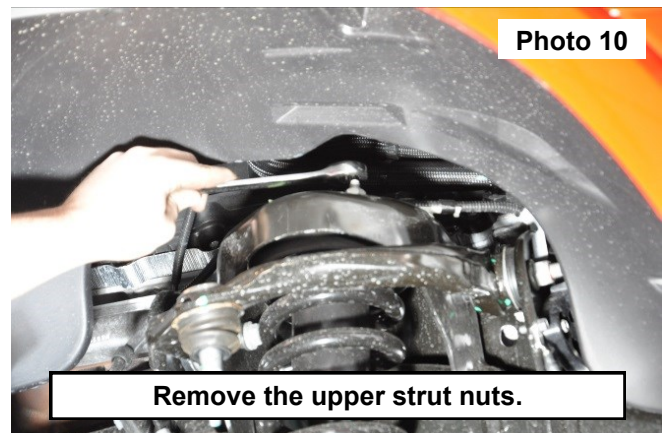
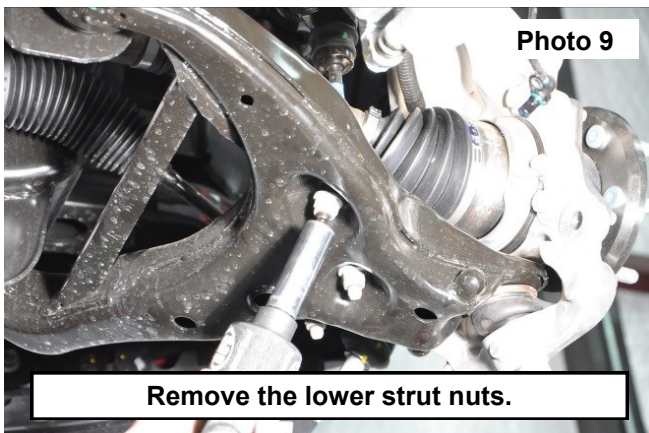

**▲ NOTICE** We recommend using OE instructions for disassembly and assembly of IWE actuator, the following instructions are for reference only.

15. Using a 8mm wrench, remove the (3) bolts securing the actuator to the knuckle. **See Photo 11.**
16. Push CV axle inward allowing the knuckle to pivot outward to allow for more clearance to remove the strut.  
**NOTE: If installing N3 Loaded Struts, V2 Monotube Shocks, or Vertex Coilovers, refer to the instructions provided with those kits and skip to step 26.**
17. Make an alignment mark on the strut through the top hat, coil spring and the strut. **See Photo 12.**

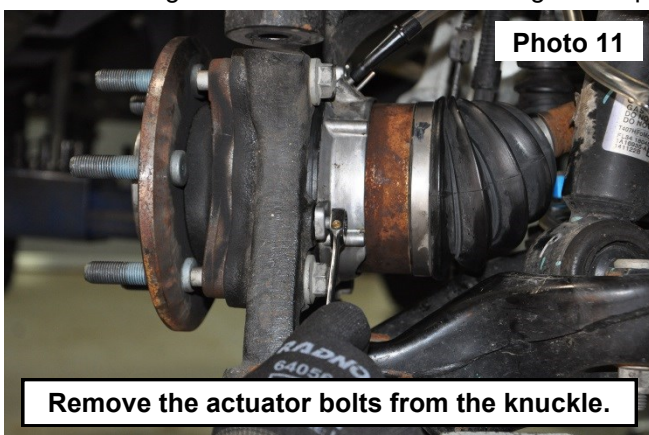

18. Compress the strut in the strut compressor. Then use a 15mm socket to remove the nut from the top of the strut, remove the strut. **See Photo 13.**
19. Remove the top hat from the rubber isolator leaving the rubber isolator on the coil spring. **See Photo 14.**

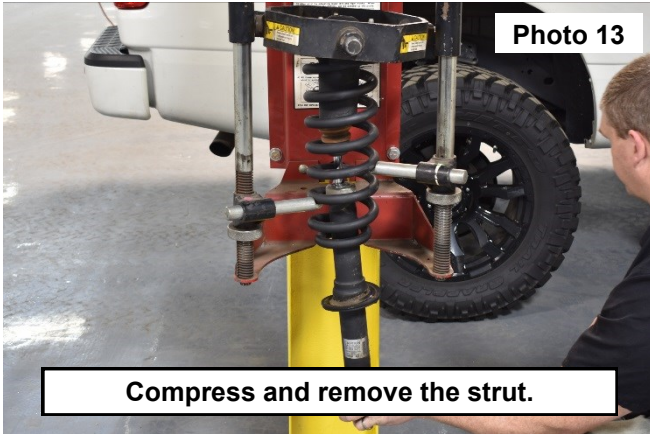

20. Place the (2) preload spacers onto the isolator and install the top hat. **See Photo 15.**
21. Line up the marks made on each part and install onto the coils spring. **See Photo 16.**

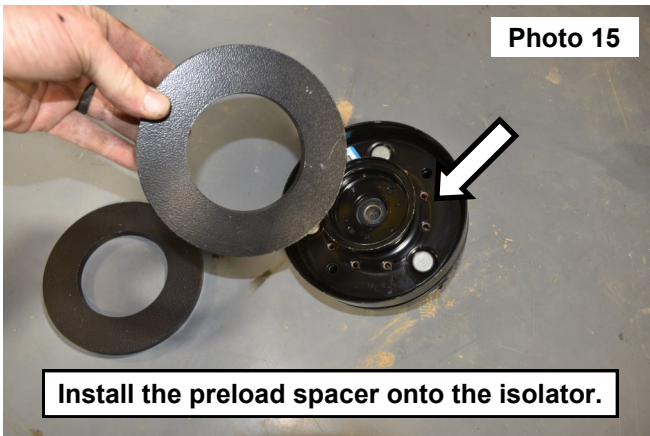

22. Install the strut lining the marks up and tighten using a 15mm socket. **See Photo 17.**
23. Insert the stud through the back side of the spacer. Use the supplied washers and nut to pull the stud into place. **See Photo 18.**



24. For 2021 Looking at the strut spacer make sure you have two (A) spacers as shown below in the CAD drawing. When installing the spacers both sides will have the RC logo to the outside.

**2021 F-150 Strut Spacers**  
**Insert studs into both A spacers**

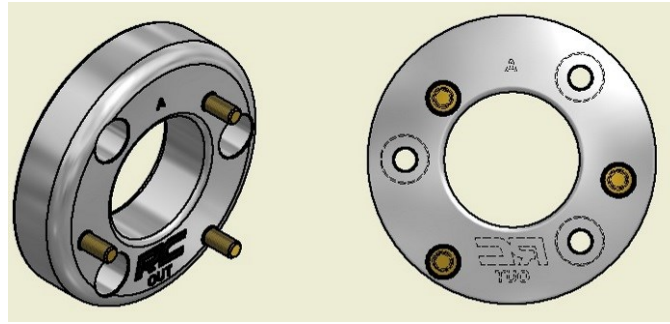

25. Install the new strut spacer on the strut use supplied 10mm nuts and 17mm socket from 569bag1. Torque to 30 ft/lbs. **See Photo 19.**
26. If equipped with the automatic adjusting headlamp sensor. Remove the ball stud nut from the upper control arm using an 8mm wrench. Retain hardware. **See Photo 20.**

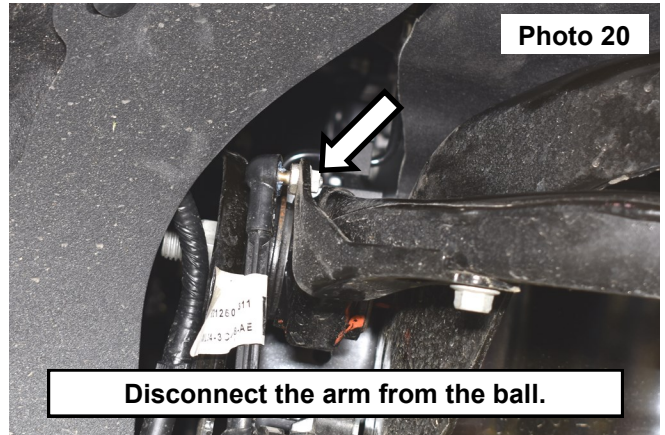
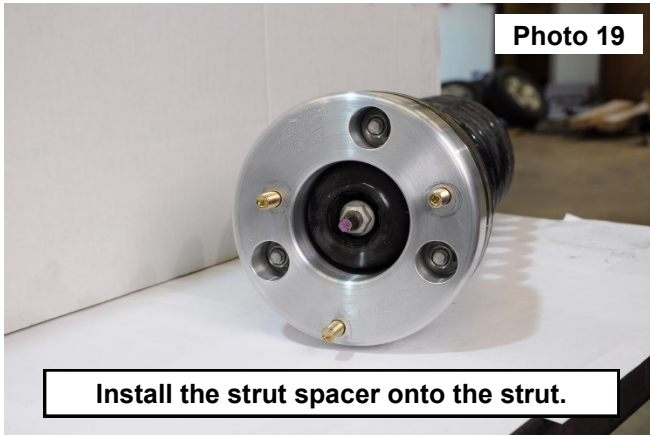

27. Remove the upper control arm using a 21mm and 22mm wrench. Retain hardware for reuse. **See Photo 21.**
28. Install the supplied headlamp adjusting bracket (**41400BAG1**) to the forged aluminum control arm using the supplied 6mm x 14mm button head bolts (**41400BAG1**). Tighten using a 4mm Allen. 2023 models - Repeat process on passenger side upper control arm. **See Photo 22.**

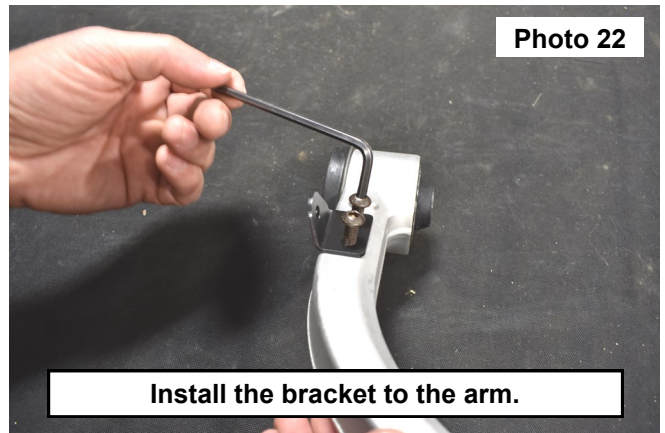
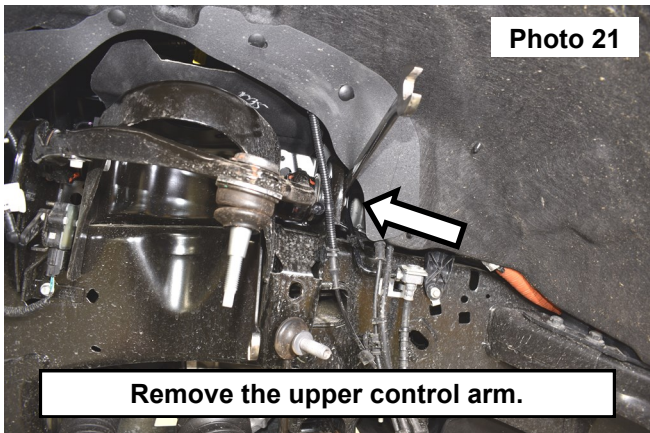

29. Install the new forged upper control arm using the factory hardware. Do not tighten at this time. **See Photo 23.**  
 30. Install the strut into upper mount using the 10mm nut, lock washer and flat washer from 569bag1. **See Photo 24.**

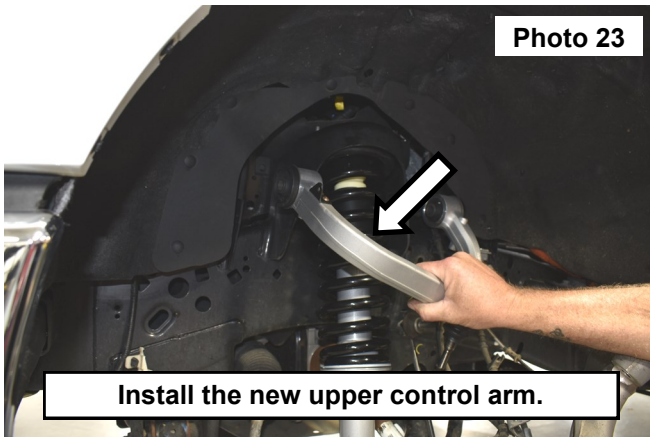

Photo 23

Install the new upper control arm.

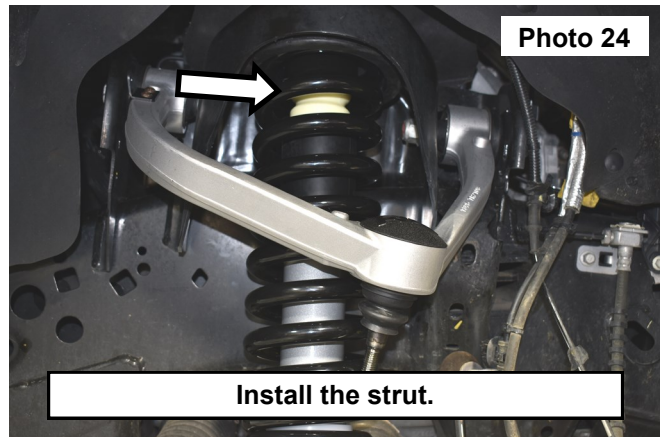

Photo 24

Install the strut.

31. Spin and align the lower mount of the strut with the lower control arm mount. Install the factory studs back into the barpin on the lower mount of the strut. It may be necessary to hit the top of the studs with a hammer to seat the splines before tightening the factory nuts with a 18mm. **See Photo 25.**  
 32. **▲ NOTICE** Make sure the actuator splines line up to the splines on the CV shaft. **See Photo 26.**

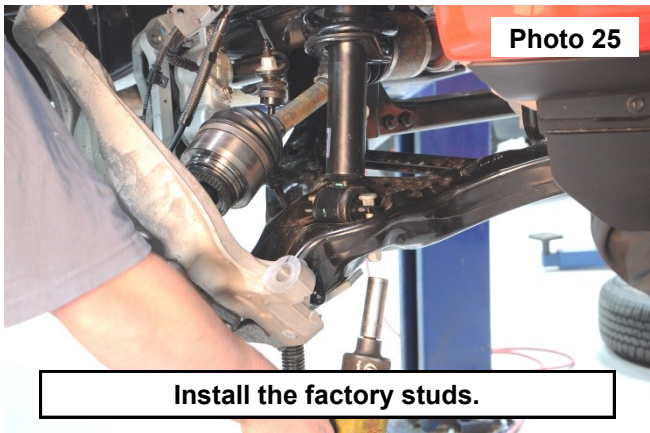

Photo 25

Install the factory studs.

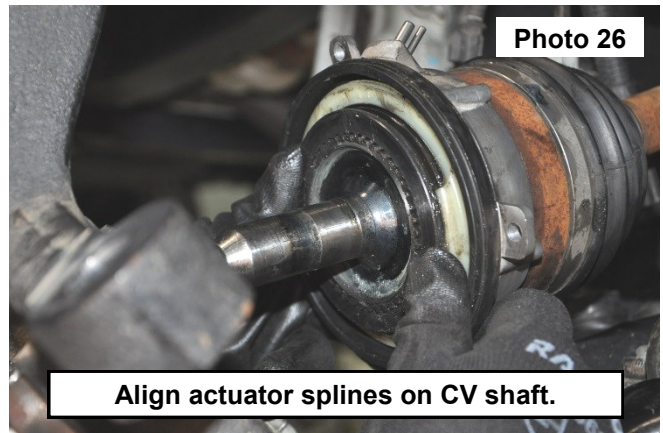

Photo 26

Align actuator splines on CV shaft.

33. Install CV shaft into the knuckle assembly. **See Photo 27.**  
 34. Using a floor jack, raise the lower control arm and connect the upper ball joint on the upper control arm to the knuckle. **See Photo 28. Ball joint must be greased before use and checked every 3000 miles.**

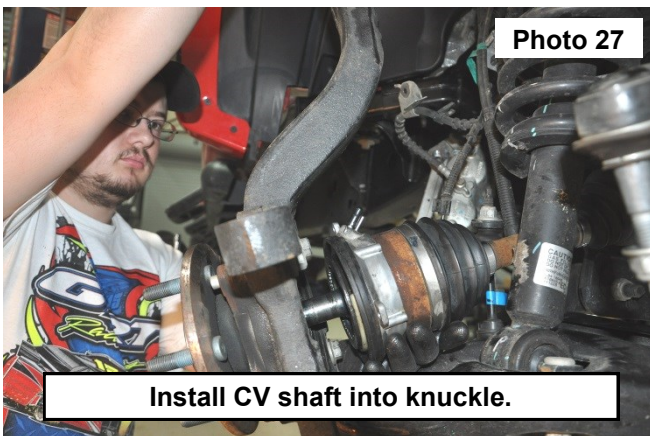

Photo 27

Install CV shaft into knuckle.

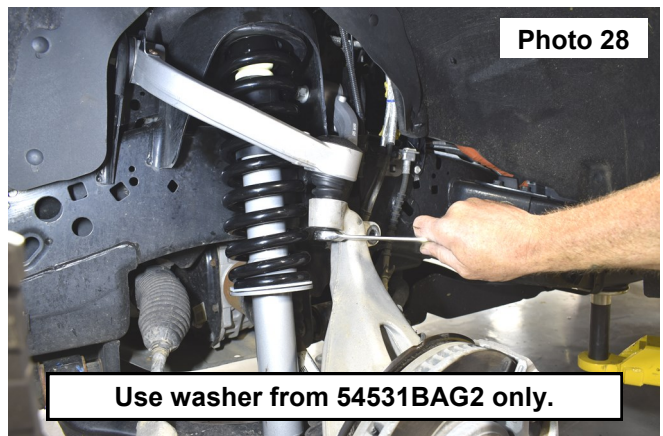
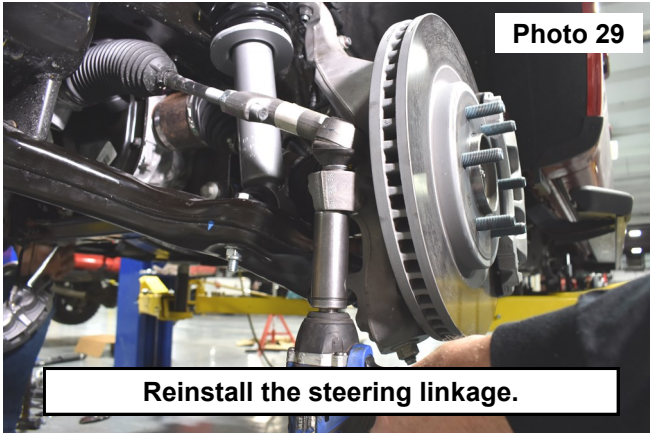

Photo 28

Use washer from 54531BAG2 only.



35. Reinstall the steering linkage nut using a 21mm wrench. **See Photos 29.**
36. Install the sway link into the knuckle using the OE nut. Tighten using a 18mm socket. **See Photo 30.**



**Reinstall the steering linkage.**

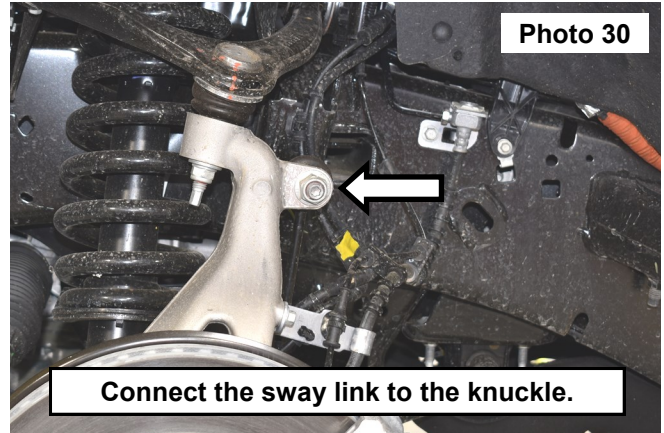

**Connect the sway link to the knuckle.**

37. Install the (3) bolts securing the actuator to the knuckle and tighten using an 8mm wrench. **See Photo 31.**
38. Measure the depth of the CV shaft threads protruding through the hub bearing. If **minimum 15.5mm or .61"** is not achieved, rotate the hub several times to eliminate binding of the splines and ensure proper seating of the CV. **See Photo 32.**
39. Install axle nut and tighten to 30 ft/lbs. **▲ NOTICE Do Not Use an impact**, caution must be taken or damage to shaft may occur.

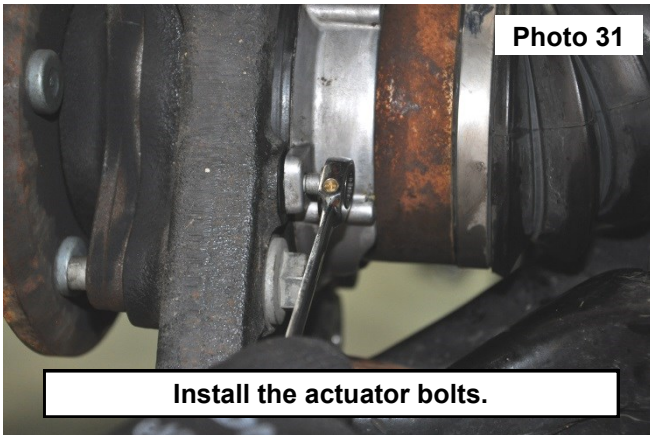

**Install the actuator bolts.**

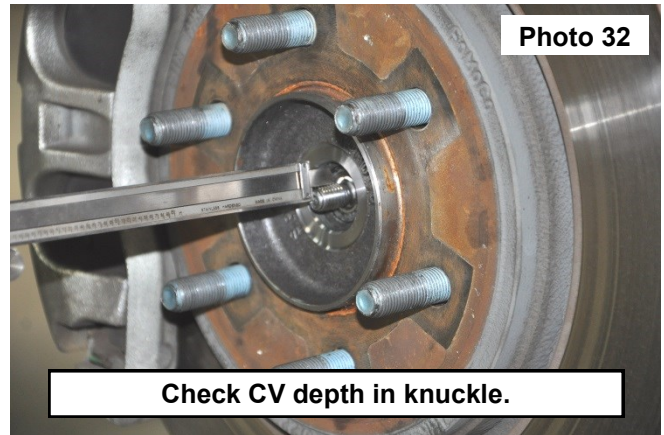

**Check CV depth in knuckle.**

40. Next slide on the brake rotor and install the brake caliper with the factory hardware and a 18mm socket.
41. Install the ABS line to the knuckle.
42. Verify free rotation of the hub with **NO** CV shaft rotation. No clicking or grinding noise should be present.
43. Activate actuator via the 4wd selector in the cabin of the vehicle. Rotate the hub to engage the actuator. You may hear/feel the actuator engage.
44. Verify that the hub and CV rotate together. Disengage the 4wd.
45. Repeat steps 4-44 on opposite side of vehicle.
46. Using a 18mm wrench, reinstall sway bar using factory hardware. Torque to factory specs.
47. Install the wheels / tires, using a 21mm deep well socket.
48. Reconnect the EPAS plugs.
49. Jack up the vehicle and remove the jack stands. Lower the vehicle to the floor and torque all bolts to factory specifications.
50. Tighten the upper control arms using a 21mm and 22mm socket.
51. Vehicle will have to have a front-end alignment.
52. If the rear block kit & shocks were ordered with the kit please proceed to the next section.

## REAR INSTALLATION INSTRUCTIONS

1. Chock the front wheels.
2. Jack up the rear of the vehicle and place jack stands underneath the frame rail.
3. Remove the tires and wheels.
4. Remove rear shocks using a 15mm, and 18mm wrench. Retain stock hardware. **See Photo 1.**
5. Place the floor jack underneath the axle and remove the stock u-bolts. **See Photo 2.**

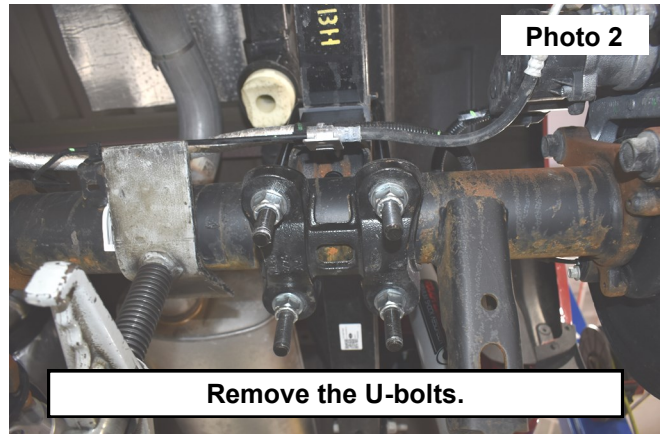
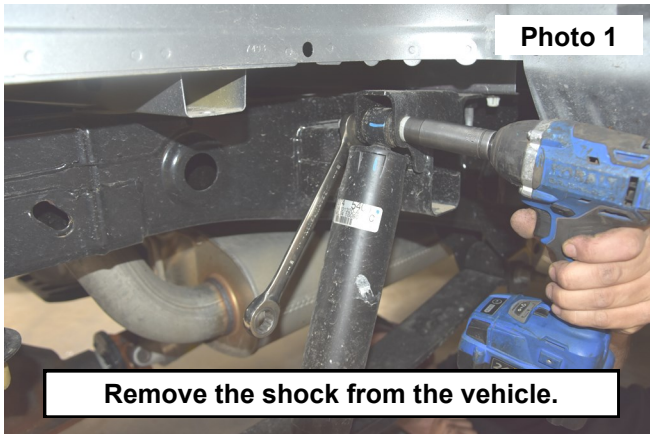

6. Lower the axle and install the new blocks on top of the OE block between the spring and the axle perch. **See Photo 3.**

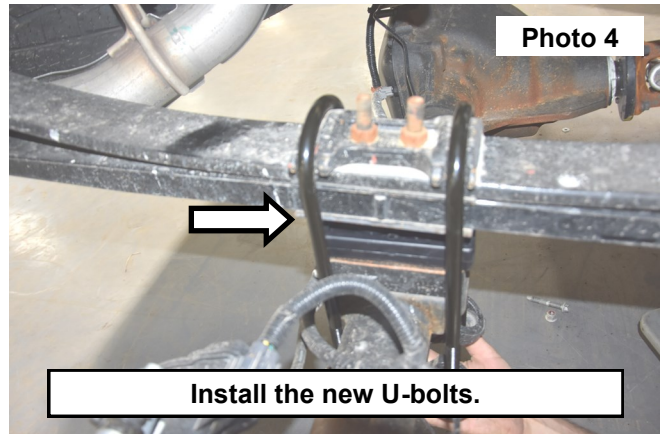
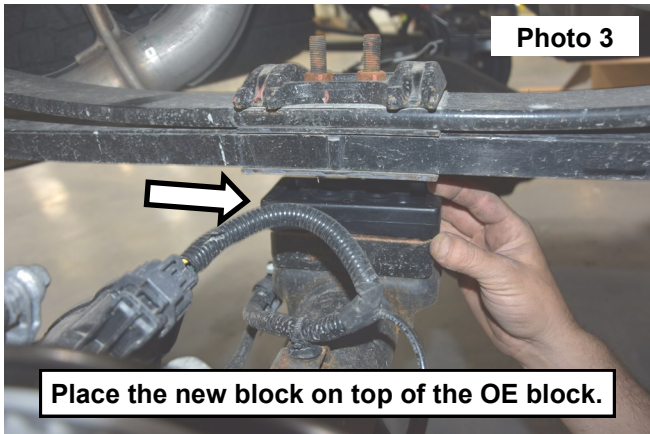

7. Install the new u-bolts and secure with fasteners provided. Tighten using a 22mm socket. **See Photo 4.**
8. Install the supplied rear shocks in the stock position with stock hardware, using a 15mm and 18mm wrench. **See Photos 5 and 6. Note: N3 shock absorbers are designed to run with the body of the shock absorber on the**

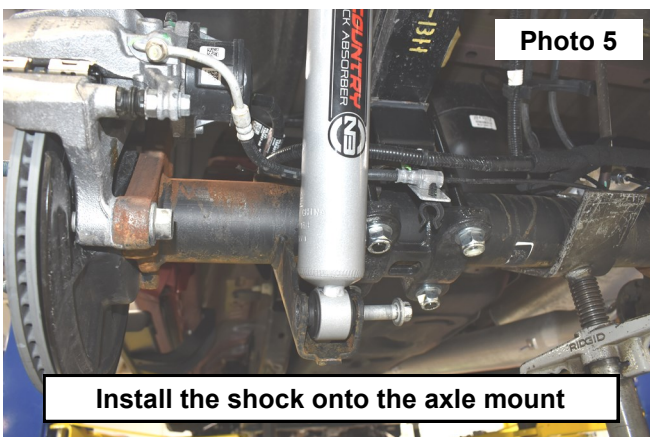

9. Install the wheels and tires
10. Using a jack. Raise the rear up and remove the jack stands, then lower onto the ground.

**⚠ WARNING** For 2015-21 Do not cut or remove factory crash bar if equipped.

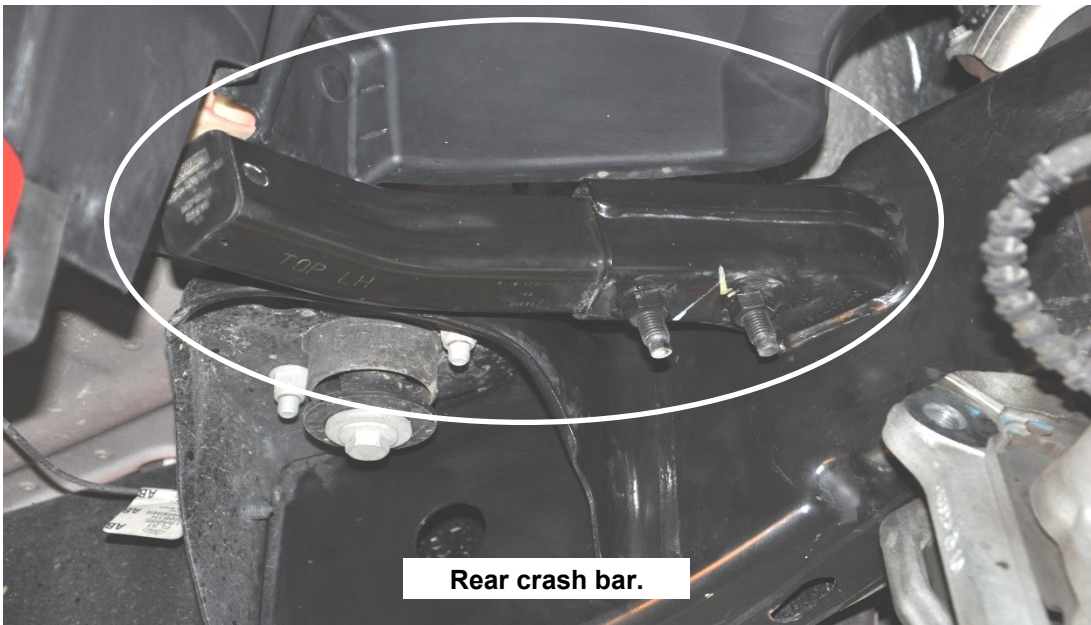
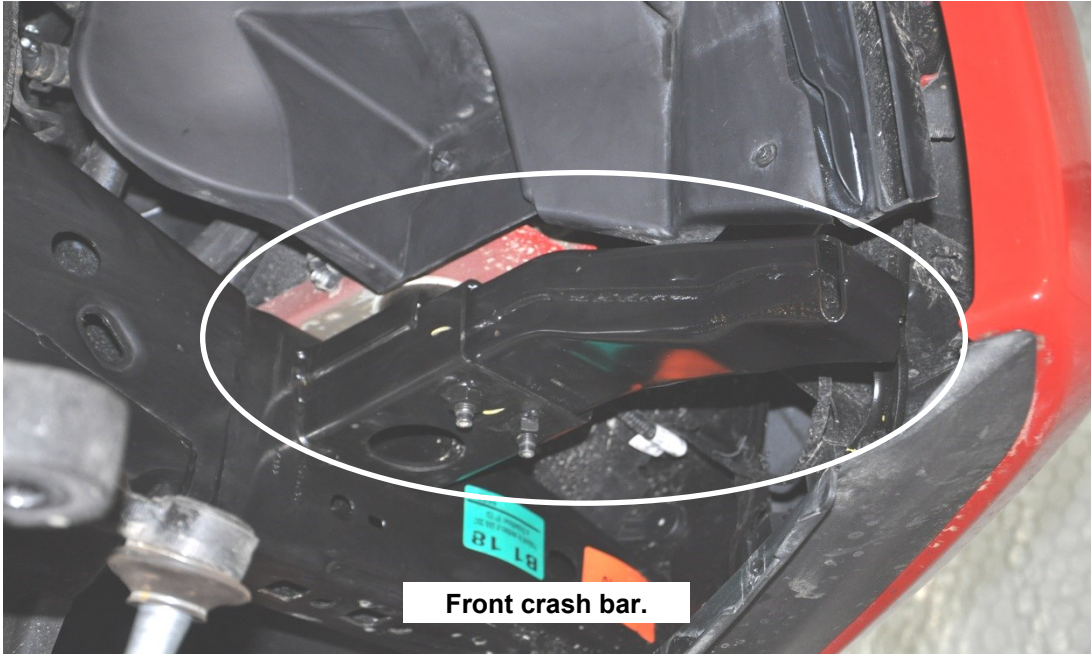

## POST INSTALLATION INSTRUCTIONS

1. Check all fasteners for proper torque. Check to ensure there is adequate clearance between all rotating, mobile, fixed and heated components. Check steering for interference and proper working order. Test brake system.
2. Perform steering sweep. The distance between the tire sidewall and the brake hose must be checked closely. Cycle the steering from full turn to full turn to check for clearance. Failure to perform inspections may result in component failure.
3. Re-torque all fasteners after 500 miles. Visually inspect components and re torque fasteners during routine vehicle service.
4. Readjust headlights to proper settings.

## MAINTENANCE INFORMATION

It is the ultimate buyers responsibility to have all bolts/nuts checked for tightness after the first 500 miles and then every 1000 miles. Wheel alignment steering system, suspension and driveline systems must be inspected by a qualified professional mechanic at least every 3000 miles

Upper control arm orientation.



**Thank you for purchasing a Rough Country Suspension System.**

By purchasing any item sold by Rough Country, LLC, the buyer expressly warrants that he/she is in compliance with all applicable, State, and Local laws and regulations regarding the purchase, ownership, and use of the item. It shall be the buyers responsibility to comply with all Federal, State and Local laws governing the sales of any items listed, illustrated or sold. The buyer expressly agrees to indemnify and hold harmless Rough Country, LLC for all claims resulting directly or indirectly from the purchase, ownership, or use of the items.

