

**ROUGH COUNTRY**  
SUSPENSION SYSTEMS®

92569000D



**569BAG3**

27.11  
[688.7 mm]

## 2014-21 Ford F150 2" Suspension Kit

Thank you for choosing Rough Country for all your suspension needs.

Rough Country recommends a certified technician install this system. In addition to these instructions, professional knowledge of disassemble/reassembly procedures as well as post installation checks must be known. Attempts to install this system without this knowledge and expertise may jeopardize the integrity and/or operating safety of the vehicle.

**▲ NOTICE** Please read instructions before beginning installation. Check the kit hardware against the parts list on the next page. Be sure you have all needed parts and know where they go. Also please review tools needed list and make sure you have the needed tools.

### PRODUCT USE INFORMATION

**▲ WARNING** As a general rule, the taller a vehicle is, the easier it will roll. Seat belts and shoulder harnesses should be worn at all times. Avoid situations where a side rollover may occur. Generally, braking performance and capability are decreased when larger/heavier tires and wheels are used. Take this into consideration while driving. Do not add, alter, or fabricate any factory or after-market parts to increase vehicle height over the intended height of the Rough Country product purchased. Mixing component brands is not recommended. Rough Country makes no claims regarding lifting devices and excludes any and all implied claims. We will not be responsible for any product that is altered. If questions exist we will be happy to answer any questions concerning the design, function, and correct use of our products.

**▲ NOTICE** This suspension system was developed on a **2014** model using a 35X12.50X18, tire with factory wheels. **We suggest a 33X12.50 on 2015 & up models.** Note if wider tires are used, offset wheels will be required and trimming will be required.

**▲ WARNING** This vehicle will require the EPAS (Electronic Power Assist Steering) plugs to be disconnected prior to beginning installation of this kit. See installation instructions. Failure to disconnect these plugs may result in damage to the EPAS module resulting in an error message being displayed, which will require replacement of the EPAS module.

### DEALER AND VEHICLE OWNER

**▲ NOTICE** Any vehicle equipped with any Rough Country product should have a "Warning to Driver" decal installed on the inside of the windshield or on the vehicle's dash. The decal should act as a constant reminder for whoever is operating the vehicle of its unique handling characteristics.

INSTALLING DEALER - it is your responsibility to install the warning decal and forward these installation instructions on to the vehicle owner for review. These instructions should be kept in the vehicle for its service life.

**▲ NOTICE** Note to installer : Before installation begins we recommend that a test drive be performed. While driving check for uncommon sounds and/or vibrations . What you feel and hear during the test drive will only magnify once lift kit is installed. Advise you to discuss possible issues identified from drive with customer before proceeding to install this kit.



**Kit Contents:**

- 2-Front Strut Extensions
- 1-Kit Bag that includes
- 6-10mm Washers
- 6-10mm Lock Nuts

**2015 Models**

1-569Bag1



**Tools Needed**

- 15mm Wrench
- 15mm Socket
- 29mm Socket
- 1 1/16" Wrench
- 21mm Wrench
- 16 mm Wrench
- 21 mm Wrench
- 3/8" mm Wrench
- 9/16" Wrench
- 9/16" Socket
- Hammer
- Floor Jack
- Jack Stands
- 18mm Socket

**Torque Specs:**

Size	Grade 5	Grade 8
5/16"	15 ft/lbs	20 ft/lbs
3/8"	30 ft/lbs	35 ft/lbs
7/16"	45 ft/lbs	60 ft/lbs
1/2"	65 ft/lbs	90 ft/lbs
9/16"	95 ft/lbs	130 ft/lbs
5/8"	135 ft/lbs	175 ft/lbs
3/4"	185 ft/lbs	280 ft/lbs
	Class 8.8	Class 10.9
12MM	55ft/lbs	75ft/lbs
14MM	85ft/lbs	120ft/lbs
16MM	130ft/lbs	165ft/lbs
18MM	170ft/lbs	240ft/lbs



## INSTALLATION INSTRUCTIONS

1. Jack up the front of the vehicle and support the vehicle with jack stands, so that the front wheels are off the ground. Next, remove the front tires/wheels, using a 21mm deep well socket.
2. Using a 15mm socket remove the front skid, if the truck is equipped with a full front skid.
3. Remove the EPAS (Electronic Power Assist Steering) Plugs as shown located on the steering assembly by the front differential. **See Photo 1 & 2. This must be done BEFORE installation is started.**

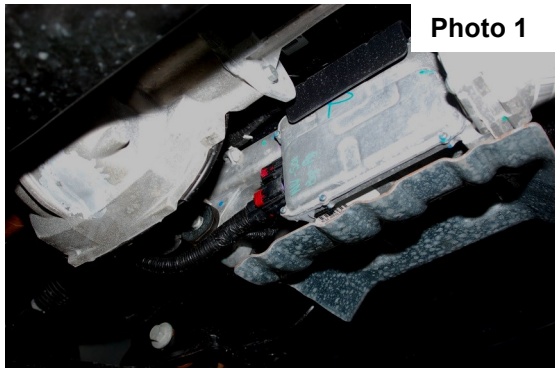

4. Using a 21mm wrench remove the nut from the tie rod on the knuckle. Using the appropriate tool, remove the tie rod from the knuckle. Push linkage forward to make room for installation. Retain factory hardware. **See Photo 3.**
5. Using a 8mm socket remove the ABS bracket from the knuckle and also remove the brake line bracket with a 10mm socket. **See Photo 4.**

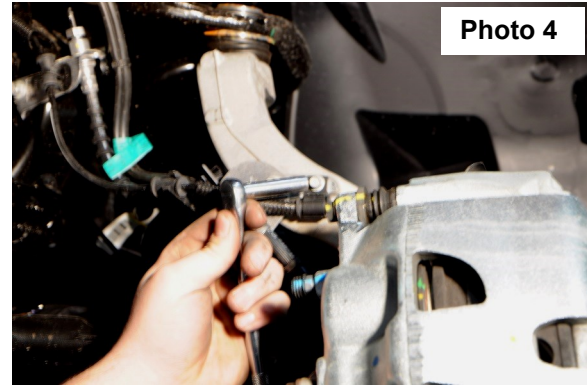
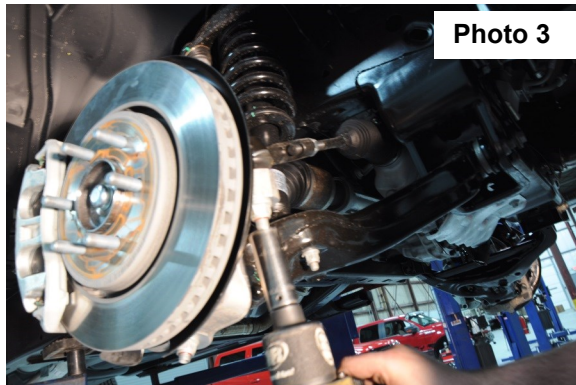

6. Next remove the caliper bolts with a 18mm socket as shown in **Photo 5** and the dust shield bolts with a 8mm socket. Remove the ABS wire from the knuckle with a 5mm Allen wrench.
7. Use a pair of pliers to pull off the axle dust cap and remove the axle nut with a 15mm socket. **See Photo 6.**

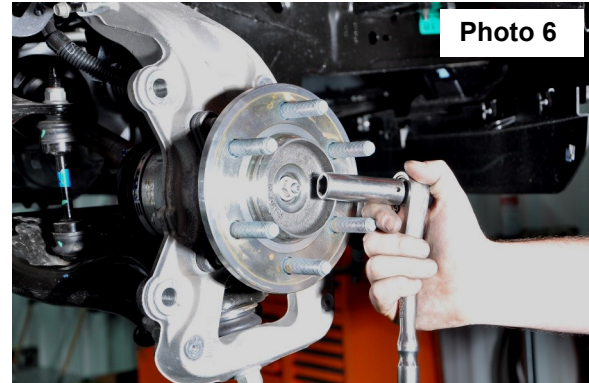
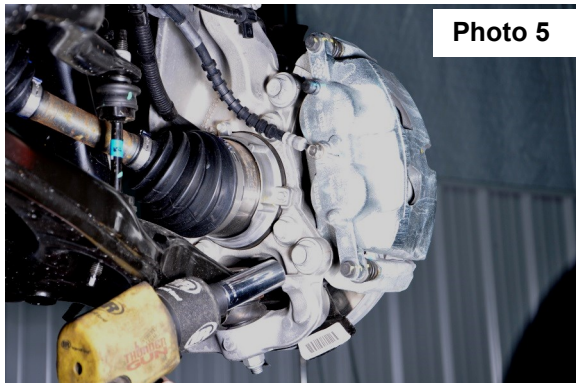

8. Remove the sway bar nut using a 18mm wrench. Retain factory hardware.
9. Using a 21mm wrench and a 1 1/16" socket loosen the lower control arm bolts. Do not remove the bolts just loosen them so you can later swing the lower control arm down.



10. Place jack stand under the knuckle for support. Remove upper control arm nut, using a 18mm wrench. Using the appropriate tool remove the ball joint to separate from the upper control arm. Do not allow the knuckle to pull out far enough that it pulls the shaft out of the differential. **\*\*Note\*\* Use caution when removing the CV axle from the knuckle. Damage to CV actuator seal will affect 4wd operation. See Photo 7.**
11. Use a 18mm socket to remove the lower strut nuts from the bottom of the control arm. **See Photo 8.** Retain factory hardware.

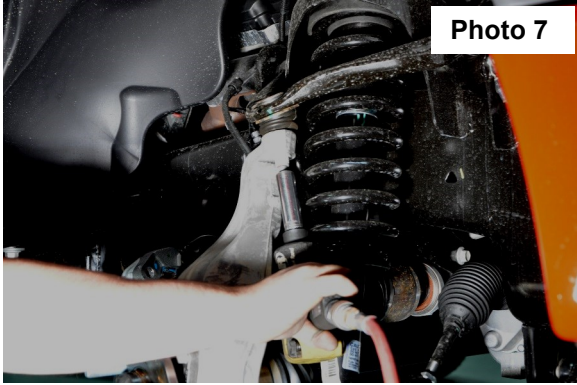

Photo 7

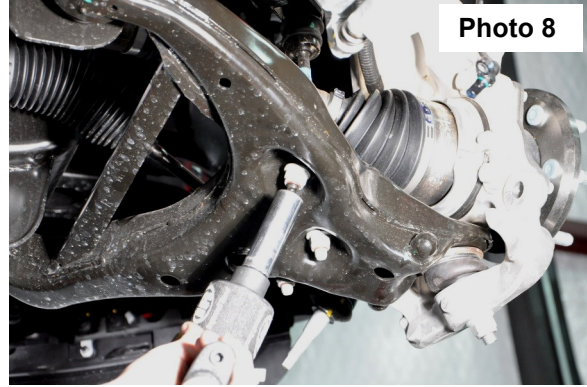

Photo 8

12. Using a 18mm wrench, remove the nuts on the upper strut tower that holds the assembly in place. **See Photo 9.**
13. Lower the jack to let the lower control arm and knuckle swing down so the strut can be removed. Place the bar pin of the lower strut mount into a vise and hand start the nuts. Next use a hammer and knock the studs out of the bar pin. Retain factory hardware for reuse. **See Photo 10.**



Photo 9

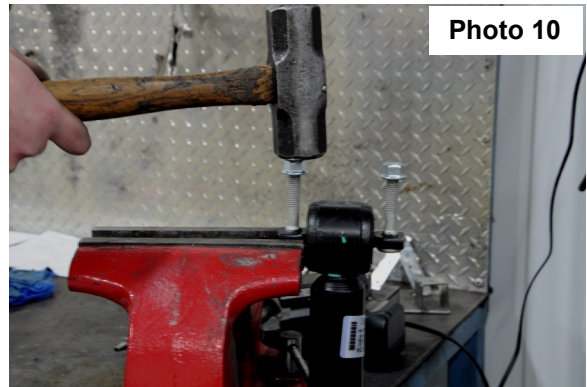

Photo 10

**▲ NOTICE** We recommend using OE instructions for disassembly and assembly of IWE actuator, the following instructions are for reference only.

14. Disconnect vacuum tubes from the actuator. **See Photo 11.**
15. Using a 8mm wrench, remove the (3) bolts securing the actuator to the knuckle. **See Photo 12.**

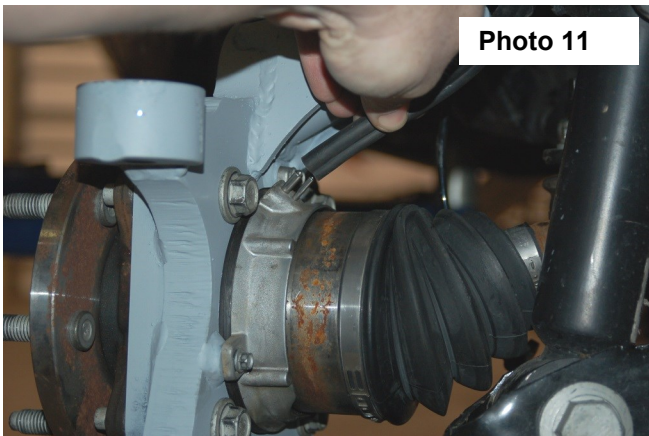

Photo 11

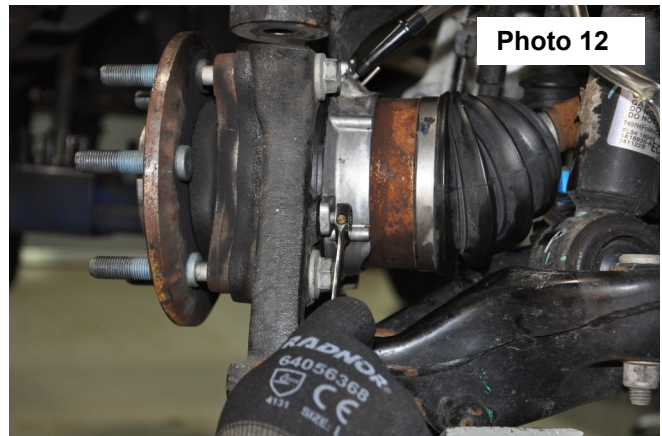
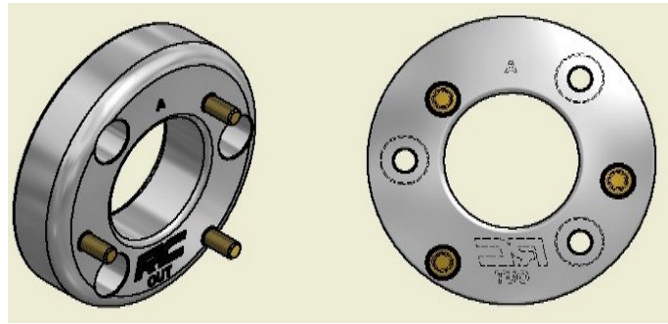

Photo 12

16. Push CV axle inward allowing the knuckle to pivot outward to allow for more clearance to remove the strut.

17. Looking at the strut spacer make sure you have two “A” spacers as shown below in the CAD drawing. Insert the stud through the back side of the spacer. Use washers and nut to pull the stud into place.

**2014-21 F-150 Strut Spacers**  
**Insert studs into both A spacers**



18. Install the new strut spacer on the strut, 2014 will use stock hardware and 9/16” socket and 2015-up will use supplied 10mm nuts and 17mm socket from 569bag1. Torque to 30 ft/lbs. **See Photo 13.**
19. Install the “A” spacer on the strut with the supplied 10mm lock nuts, make sure you have the RC logo to the outside. **See Photo 13.** Tighten with a 17mm wrench.

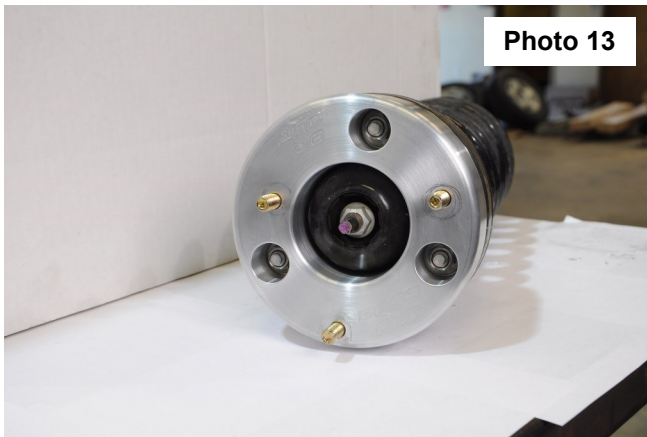

Photo 13



Photo 14

20. Spin and align the lower mount of the strut with the lower control arm mount. Install the factory studs back into the barpin on the lower mount of the strut. It may be necessary to hit the top of the strut with a hammer to seat the splines before tightening the factory nuts with a 18mm. **See Photo 15.**



Photo 15



21. **▲ NOTICE** Make sure the actuator splines line up to the splines on the CV shaft. See photo 16.

22. Install CV shaft into the knuckle assembly. See Photo 17.

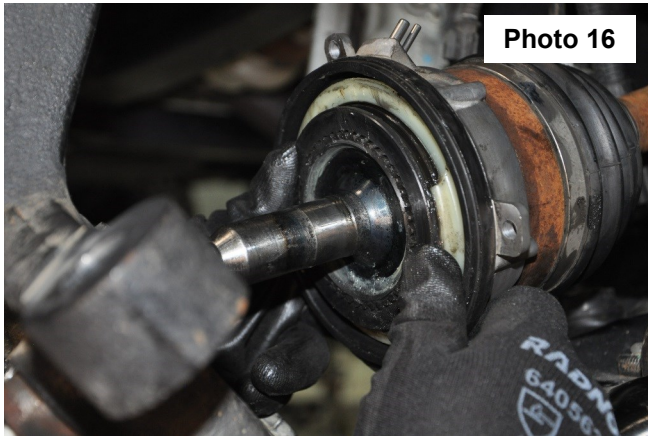

Photo 16



Photo 17

23. Using a floor jack, raise the lower control arm and connect the upper ball joint on the upper control arm to the spindle. Using a 21mm wrench, torque to manufacturer specs. If ball joint turns while tightening, use a 3/8" wrench to hold the ball joint.

24. Reinstall the steering linkage nut using a 21mm wrench.

25. Using a hand vacuum pump, apply and hold 24inHG of vacuum to the actuator through the large port. See Photos 18 and 19.

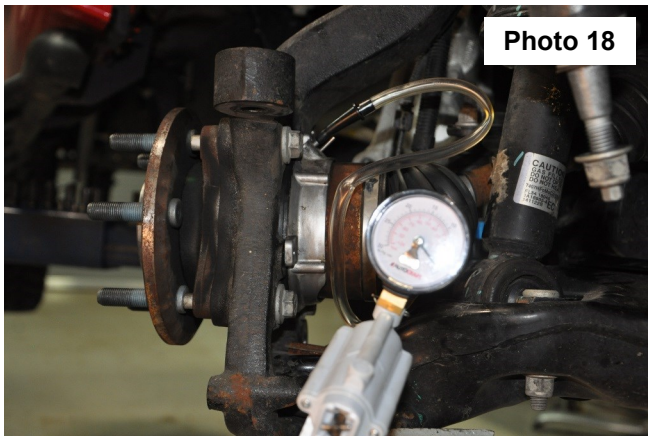

Photo 18

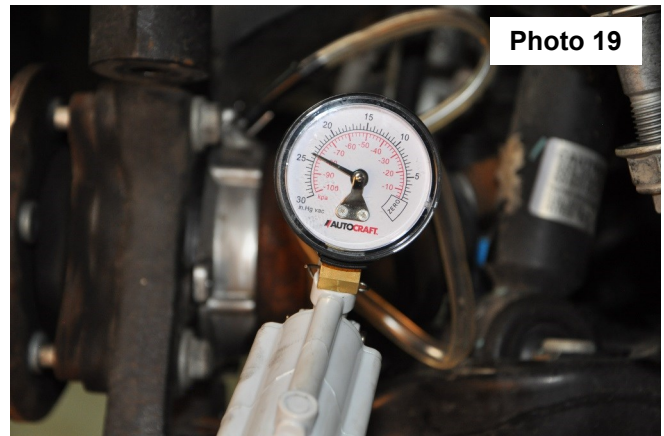

Photo 19

26. Install the (3) bolts securing the actuator to the knuckle and tighten using an 8mm wrench. See Photo 20.

27. **▲ NOTICE** With vacuum still applied to actuator. Measure the depth of the CV shaft threads protruding through the hub bearing. If **minimum 15.5mm or .61"** is not achieved, rotate the hub to eliminate binding of the splines. See Photo 21.

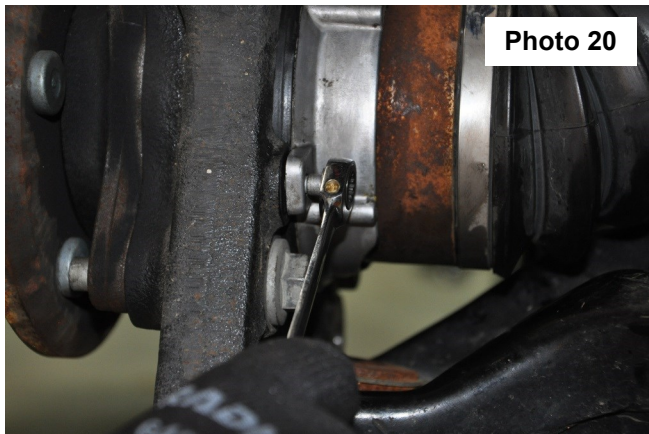

Photo 20

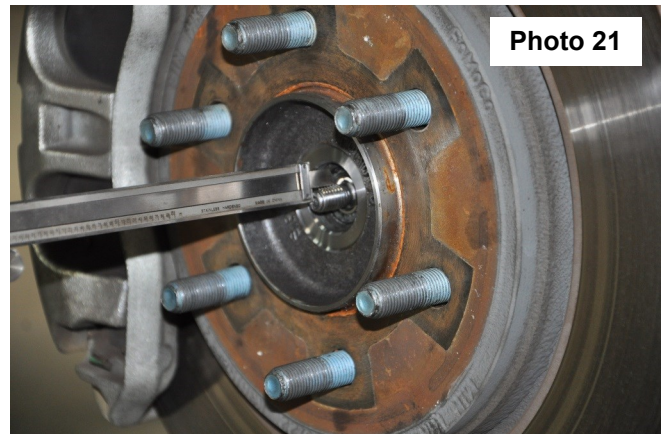

Photo 21

28. Install axle nut and tighten to 30 lb.ft. **▲ NOTICE Do Not Use an impact**, caution must be taken or damage to shaft may occur.
29. Verify free rotation of the hub with **NO** CV shaft rotation. No clicking or grinding noise should be present
30. Release the vacuum from the actuator and rotate the hub to engage the actuator. You may hear/feel the actuator engage.
31. Verify that the hub and CV rotate together. Reconnect the vacuum lines to the actuator.
32. Next slide on the brake rotor and install the brake caliper with the factory hardware and a 18mm socket.
33. Install the ABS line to the knuckle.
34. Repeat steps 4-33 on opposite side of vehicle.
35. Using a 18mm wrench, reinstall sway bar using factory hardware. Torque to factory specs.
36. Install the wheels / tires, using a 21mm deep well socket.
37. Reconnect the EPAS plugs.
38. Jack up the vehicle and remove the jack stands. Lower the vehicle to the floor and torque all bolts to factory specifications.
39. Vehicle will have to have a front-end alignment.
40. If the rear block kit & shocks were ordered with the kit please proceed to the next section.

## REAR INSTALLATION INSTRUCTIONS

1. Chock the front wheels.
2. Jack up the rear of the vehicle and place jack stands underneath the frame rail. Lower the
3. Remove the tires and wheels.
4. Remove rear shocks using a 15mm, and 18mm wrench. Save the stock hardware it will be used later.
5. Place the floor jack underneath the axle and remove the stock u-bolts. Lower the axle down to allow the blocks to be installed in between the stock block and the spring perch. Install the new u-bolts and secure with fasteners provided.
6. Install rear shocks in the stock position with stock hardware, using a 15mm and 18mm wrench. **Note: N3 shock absorbers are designed to run with the body of the shock absorber on the axle mount and the piston rod on the frame end.**





**⚠ WARNING** Do not cut or remove factory crash bar if equipped.

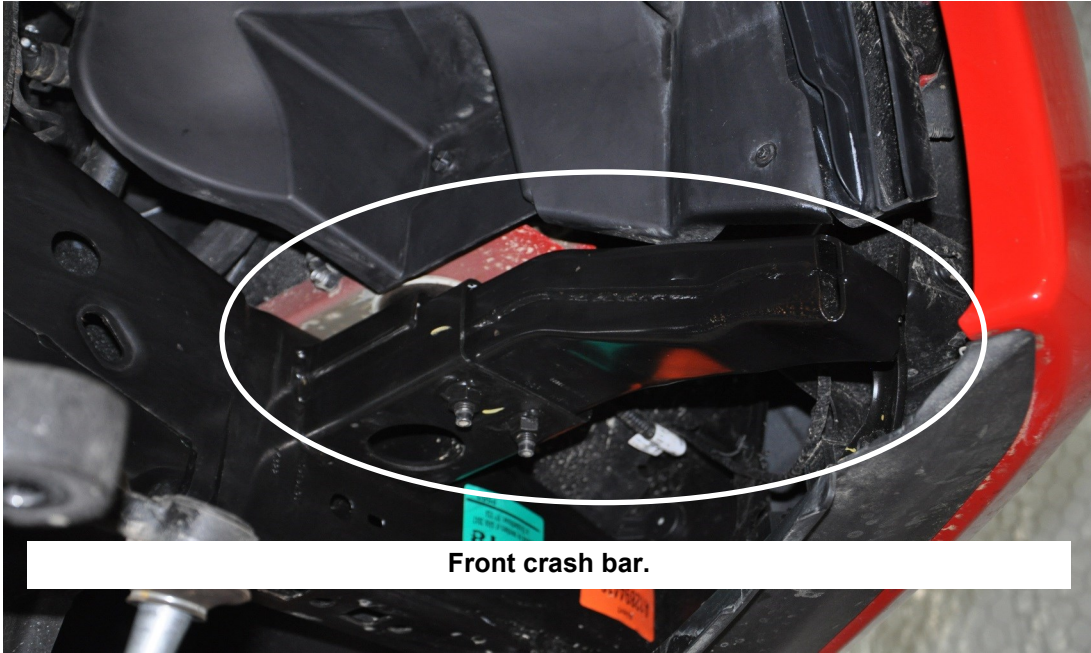



## POST INSTALLATION INSTRUCTIONS

1. Check all fasteners for proper torque. Check to ensure there is adequate clearance between all rotating, mobile, fixed and heated members. Check steering for interference and proper working order. Test brake system.
2. Perform steering sweep. The distance between the tire sidewall and the brake hose must be checked closely. Cycle the steering from full turn to full turn to check for clearance. Failure to perform inspections may result in component failure.
3. Re torque all fasteners after 500 miles. Visually inspect components and re torque fasteners during routine vehicle service.
4. Readjust headlights to proper settings.

## MAINTENANCE INFORMATION

It is the ultimate buyers responsibility to have all bolts/nuts checked for tightness after the first 500 miles and then every 1000 miles. Wheel alignment steering system, suspension and driveline systems must be inspected by a qualified professional mechanic at least every 3000 miles



By purchasing any item sold by Rough Country, LLC, the buyer expressly warrants that he/she is in compliance with all applicable, State, and Local laws and regulations regarding the purchase, ownership, and use of the item. It shall be the buyers responsibility to comply with all Federal, State and Local laws governing the sales of any items listed, illustrated or sold. The buyer expressly agrees to indemnify and hold harmless Rough Country, LLC for all claims resulting directly or indirectly from the purchase, ownership, or use of the items.

