



baja designs[®]
THE SCIENTISTS OF LIGHTING

44-8153, 44-8157 Universal S1 Hitch Light Kit



2950 Norman Strasse Rd. • San Marcos • CA • 92069

Phone 760-560-2252x3 • Fax 760-560-0383

info@bajadesigns.com • www.bajadesigns.com



baja designs[®]
THE SCIENTISTS OF LIGHTING

LIMITED LIFETIME WARRANTY

Baja Designs proudly offers a LIFETIME WARRANTY against manufacturer's defect on all the products that we manufacture.

These are comprehensive warranties; other than the exclusions below – you're covered. If your LED or HID bulb burns out, you're covered. Additionally, cutting off our connector or changing your lenses does not automatically void your warranty.

Exclusions:

Installation errors, abuse, misuse or crash damage. You must be the original owner of the product and can supply proof of purchase.

Baja Designs manufactures its own products as well as resells products manufactured by others. Baja Designs makes no express or implied warranties on products not manufactured by Baja Designs including without limitation any warranties or merchantability and fitness for a purpose. We will, however, pass on all warranties made by the manufacturer, who has sole responsibility for performing such warranties.

Baja Designs will pay the freight if your product is less than 90 days old, otherwise defective products must be returned to Baja Designs, Inc., freight prepaid. At our option, we will repair or replace items in question and return them at no charge. If the identical product is no longer available, we will replace with a similar product of equal value. Baja Designs Inc. will not be responsible for any indirect or consequential damages in connection with defective merchandise.

Items purchased through a Baja Designs authorized dealer must be returned through the dealer. Only available on LED auxiliary lights and product must be in sellable condition at MSRP. Product that has been damaged in any way after the original purchase date will be excluded from this guarantee.

Indemnification:

Buyer hereby acknowledges off-roading, racing and driving at night are dangerous activities and that the products and/or supplies purchased from Baja Designs are used in an inherently dangerous activity that may endanger life and limb; and in no event shall the seller, or seller's heirs and assigns, be held liable for consequential damages, nor shall seller's liability on any claim for damages arising out of or connected with the sale, delivery, or use of purchased products and/or supplies exceed the purchase price of the products and/or supplies

Tools Required

- * 2.5mm allen key
- * Step-drill bit
- * Marking pen

1. Make sure the vehicle is parked on level ground and the ignition is off. Hold the included hitch mount adapter such that the two bolt holes on the side are on the bottom.

2. fully slide your hitch mount adapter into the hitch receiver. Using a sharpie, mark each side of the hitch mount adapter where the holes of the hitch pin align.

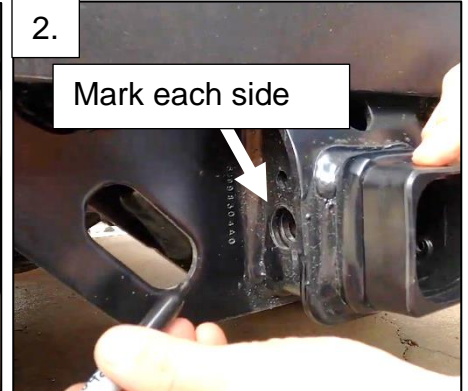
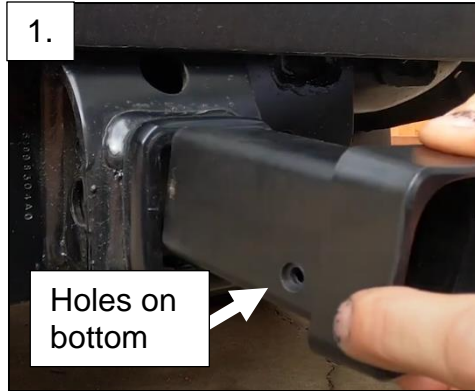

3. Using a step bit, drill out holes in the hitch mount adapter on each side.

4. Using a 2.5mm Allen key and parts bag, assemble your included S1 light onto the hitch mount adapter as shown in the accompanying image. Make sure that the side bolts are completely flush with the hitch mount adapter so that they do not prevent it from fully sliding into the hitch. Also, make sure you pull the Baja designs light completely through the tow hitch.

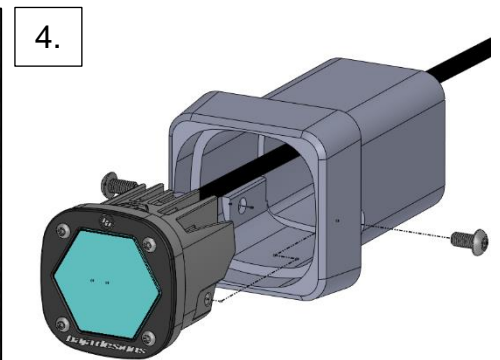
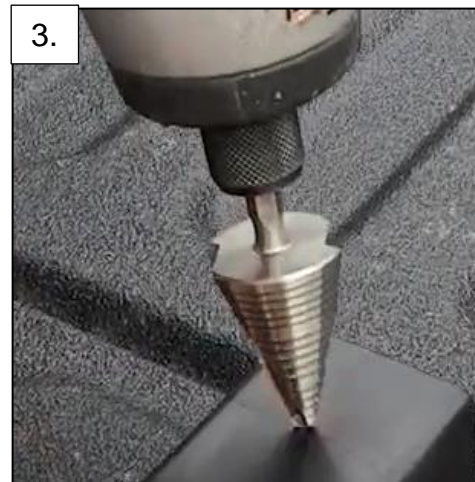

5. Insert the hitch pin completely through the hitch receiver and the hitch mount adapter. Then lock the pin on the other side using a cotter pin so that the light does not come out.



NOTE* If you purchased the reverse trigger harness (44-8153), then follow steps 6,7, 8 and 10, skip step 9.
 If you purchased the Toggle switch harness (44-8157), then follow steps 9 and 10, skip steps 6,7 and 8.

6. Now, from underneath your vehicle, find the hitch plug. It will be directly behind the plug that you plug your trailer hitch into. Unplug the connector on the back of the truck.

7. Using the provided plug and play wiring harness in the kit, plug the opposite side of the connector into your vehicles OEM wiring harness. Then, install the other side of your provided wiring harness back into the hitch plug.

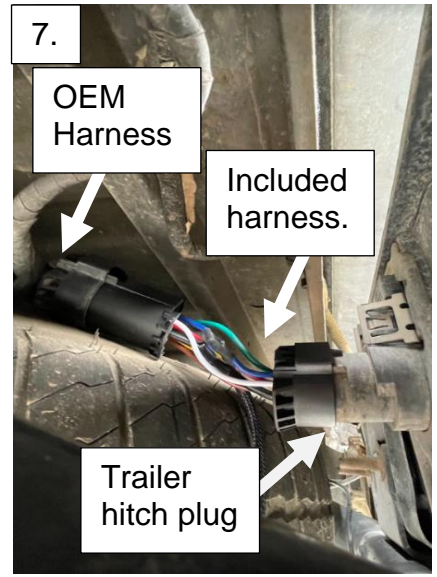

8. NOTE* - Some vehicles have a plastic ring around the connector that prevents the included reverse harness from seating correctly. If you don't hear or feel a "click" when mating the harness to the connector, simply grab some pliers and pull the extra connector component off the stock connector. This piece is especially apparent on Ford vehicles.

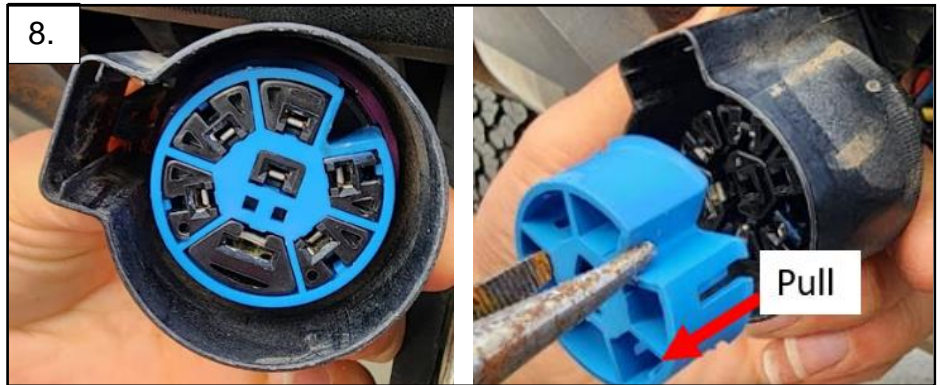

9. The toggle switch harness is powered off the battery of your vehicle. Please refer to the following wiring diagram for a basic overview of how to wire the vehicle.

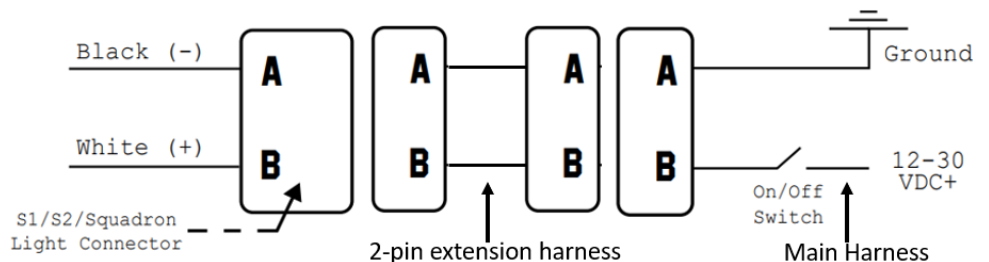
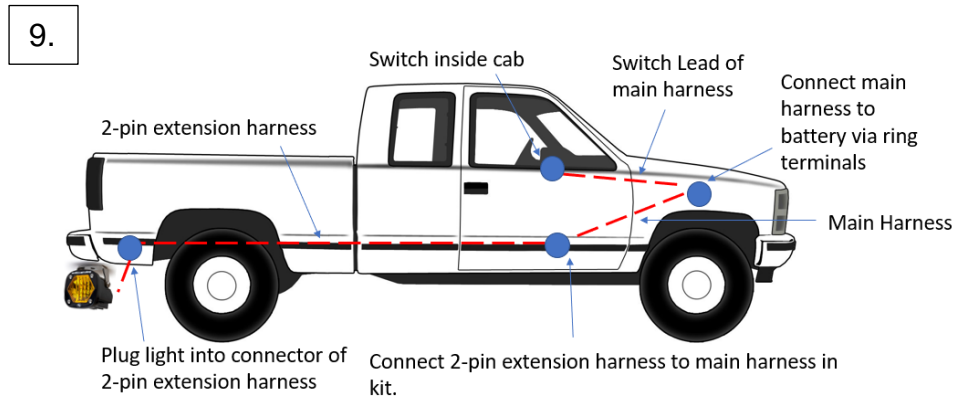

10. Now, plug in the Baja Designs S1 plug into the included wiring harness lead. Zip tie all wires so that they do not interfere with any objects and can't break free. The light should turn on when the vehicle is on and in reverse if you purchased 44-8153, otherwise if you purchased 44-8157 then the light should turn on when the vehicle is on and the toggle switch is on.



*Tie all wires away from sharp, hot, and/or rotating components.

* Re-torque all the fasteners after 100 miles.

*Your install is now complete! Thank you for choosing Baja Designs.