

2021+ FORD F150 XB LED HEADLIGHTS INSTALL GUIDE

WARNING: By reading this document, you agree it is only to be used as an educational guide. Morimoto Lighting nor its dealers make guarantees on any finished results, nor are they to be held responsible for any damage, misuse, or personal injuries. If you are unable to clearly understand and adapt the information below, professional installation is recommended.

PACKAGE CONTENTS



**2X HEADLIGHT ASSEMBLIES
(WHITE OR AMBER)**



1 X DRL HARNESS

OPTIONAL COMPONENTS



2 X LIN BUS MODULE



1 X CROSSOVER HARNESS



1 X BATTERY HARNESS

IMPORTANT: If your vehicle is equipped with anything but OEM turn signals (full assemblies, LED bulbs, or otherwise) in the tail lights or elsewhere: You may experience a hyper flash and/or problem with the sequential signal setting on these headlights. This is not a defect in the headlight, and caused by un-matched impedance with your original vehicle settings.

2021+ FORD F150



TABLE OF CONTENTS

- INSTALLATION PROCESS	PAGE 3
- VERTICAL HEADLIGHT AIMING	PAGE 13
- DISABLE DRL IN FOG LIGHT	PAGE 13
(FOR LED TRUCKS)	

REQUIRED TOOLS

- | | |
|---------------|--|
| - RATCHET | - PICK TOOL |
| - 7MM SOCKET | - FLAT HEAD SCREWDRIVER OR TRIM REMOVAL TOOL |
| - 8MM SOCKET | - PHILIPS HEAD SCREWDRIVER |
| - 10MM SOCKET | - NEEDLE NOSE PLIERS |
| - 11MM SOCKET | |

INSTALLATION PROCESS

1. Remove the fourteen (14) plastic clips holding on the grille cover. Remove the grille cover off of the truck.

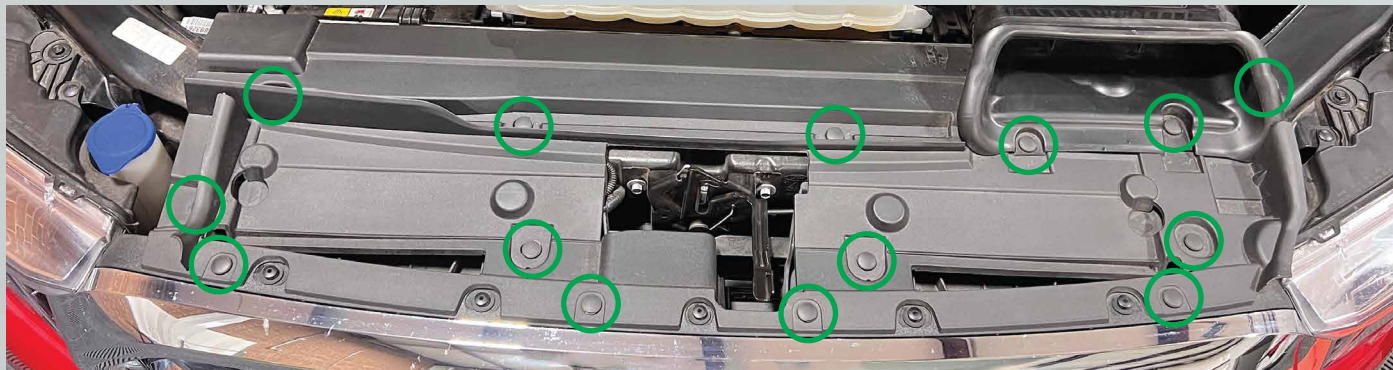

2. Remove four (4) 10mm bolts and two (2) plastic clips holding the top of the grille.



3. At the top of the grille, disconnect the grille flap motor (IMAGE 1). Disconnect the front camera wire (IMAGE 2), and release the camera washer fitting by pressing the two edges in and sliding the fitting out. Also release the camera washer hose from the holder (IMAGE 3)

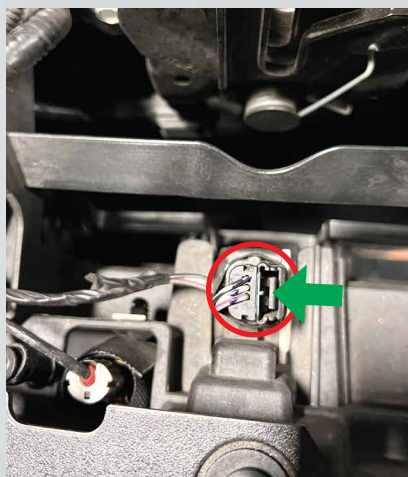

IMAGE 1



IMAGE 2

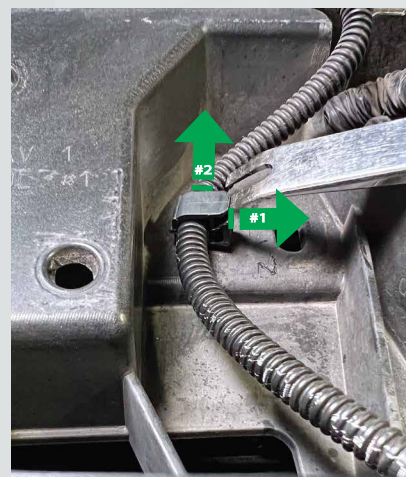

IMAGE 3

4. Remove the two (2) 7mm screws holding the bumper trim (IMAGE 4). Pry out the bumper trim away from the fender (IMAGE 5). Repeat this on the other side of the vehicle.



IMAGE 4



IMAGE 5

5. Release the bumper trim from the grille by pulling it forward away from the truck. Remove the bumper trim off of the truck.



6. Remove the two (2) 8mm screws (one on each side) holding the bottom of the grille (IMAGE 6). Pull the grille forward away from the truck (IMAGE 7). Remove the grille off of the truck.

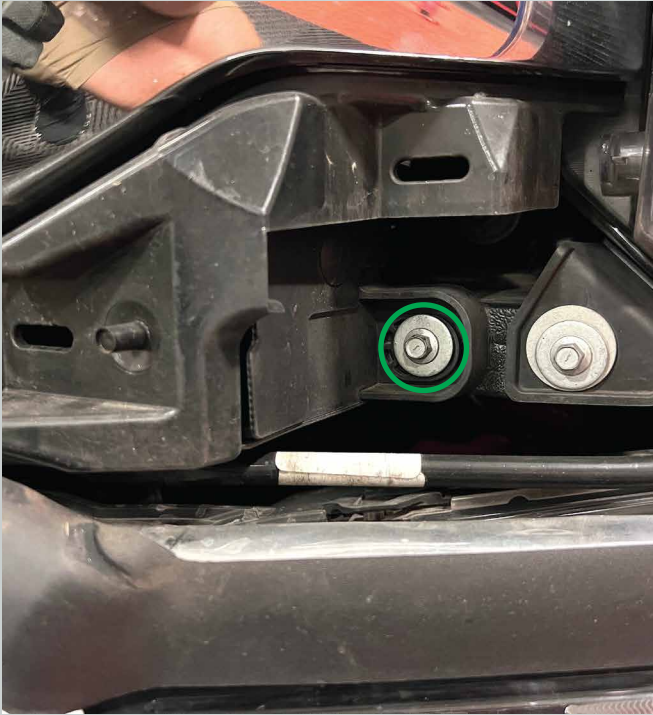

IMAGE 6

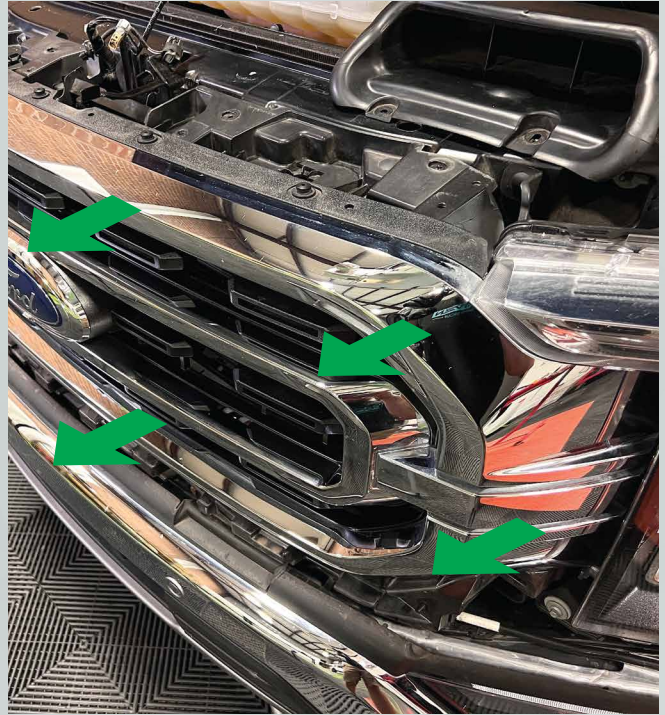

IMAGE 7

7. Remove the one (1) 8mm screw and one (1) 10mm nut holding the bottom of the headlight (IMAGE 8). Remove two (2) 10mm screws and one (1) plastic clip holding the top on the headlight (IMAGE 9).

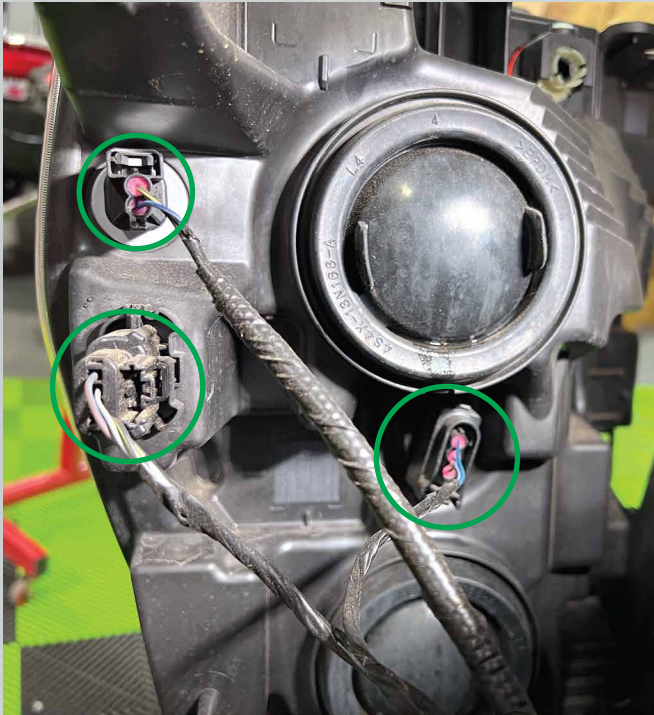

IMAGE 8

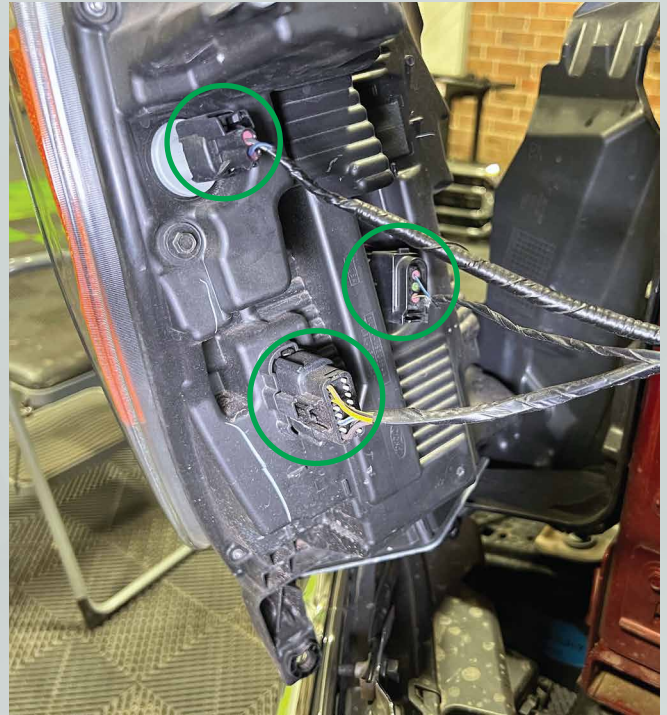

IMAGE 9

8. To remove the headlight, first slide it forward away from the truck, then unplug the three (3) connectors on the back. If you have a halogen truck see (IMAGE 10). If you have an OEM LED reflector truck see (IMAGE 11). Repeat this on the other side of the truck.



OEM HALOGEN
IMAGE 10



OEM LED REFLECTOR
IMAGE 11

9. Locate the fuse box under the hood on the passenger side, by the firewall and remove fuse #25. Find the included fuse tap harness and plug it in place of the fuse you just removed. Route one end of the harness to the passenger side headlight area and the other end to the driver side headlight area.

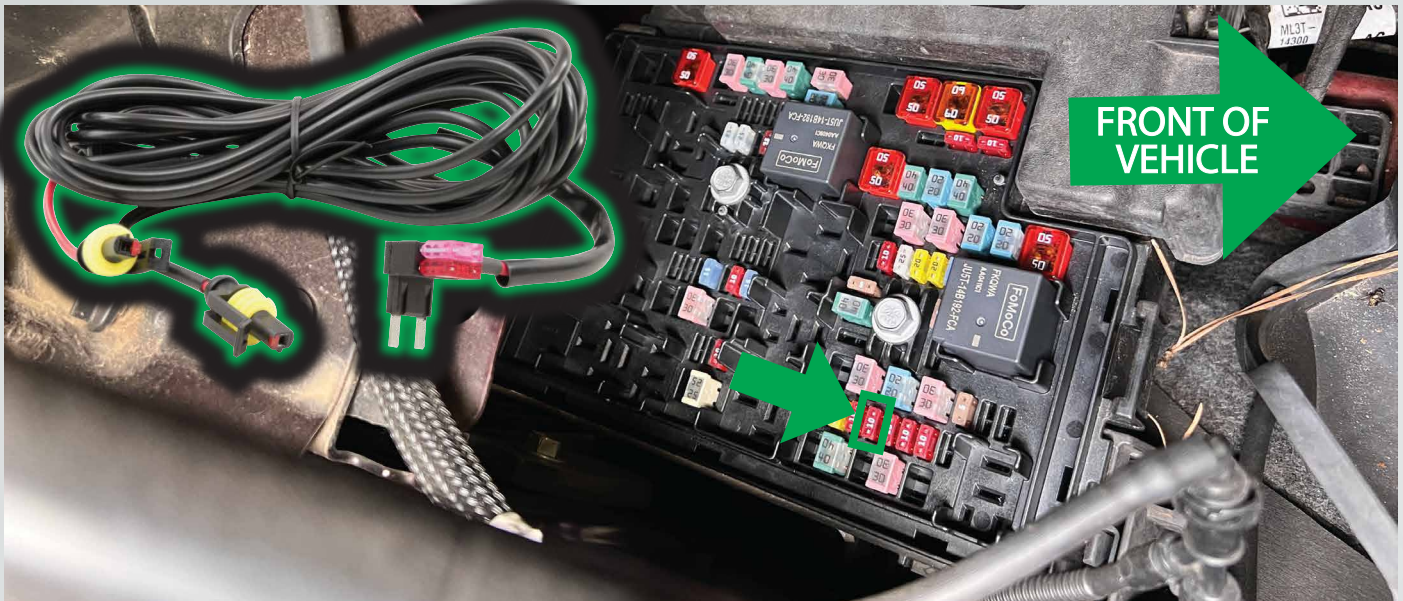

OEM HEADLIGHT IDENTIFIER



OEM LED REFLECTOR (PROCEED TO PAGE 8)



OEM HALOGEN (PROCEED TO PAGE 13)

10. -Locate the included Battery Harness, go to the battery and remove the 11mm nut on the positive terminal. Install the positive lead (red wire) onto the stud on the positive terminal, and reinstall the 11mm nut.
-Install the negative lead from the Battery Harness (black wire). Remove the 10mm nut on the negative terminal, install the negative lead (black wire) and reinstall the 10mm nut.
-Run the other end of the Battery Harness to the passenger side headlight opening.

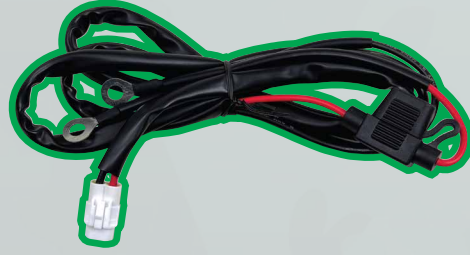

(HARNES ROUTING)

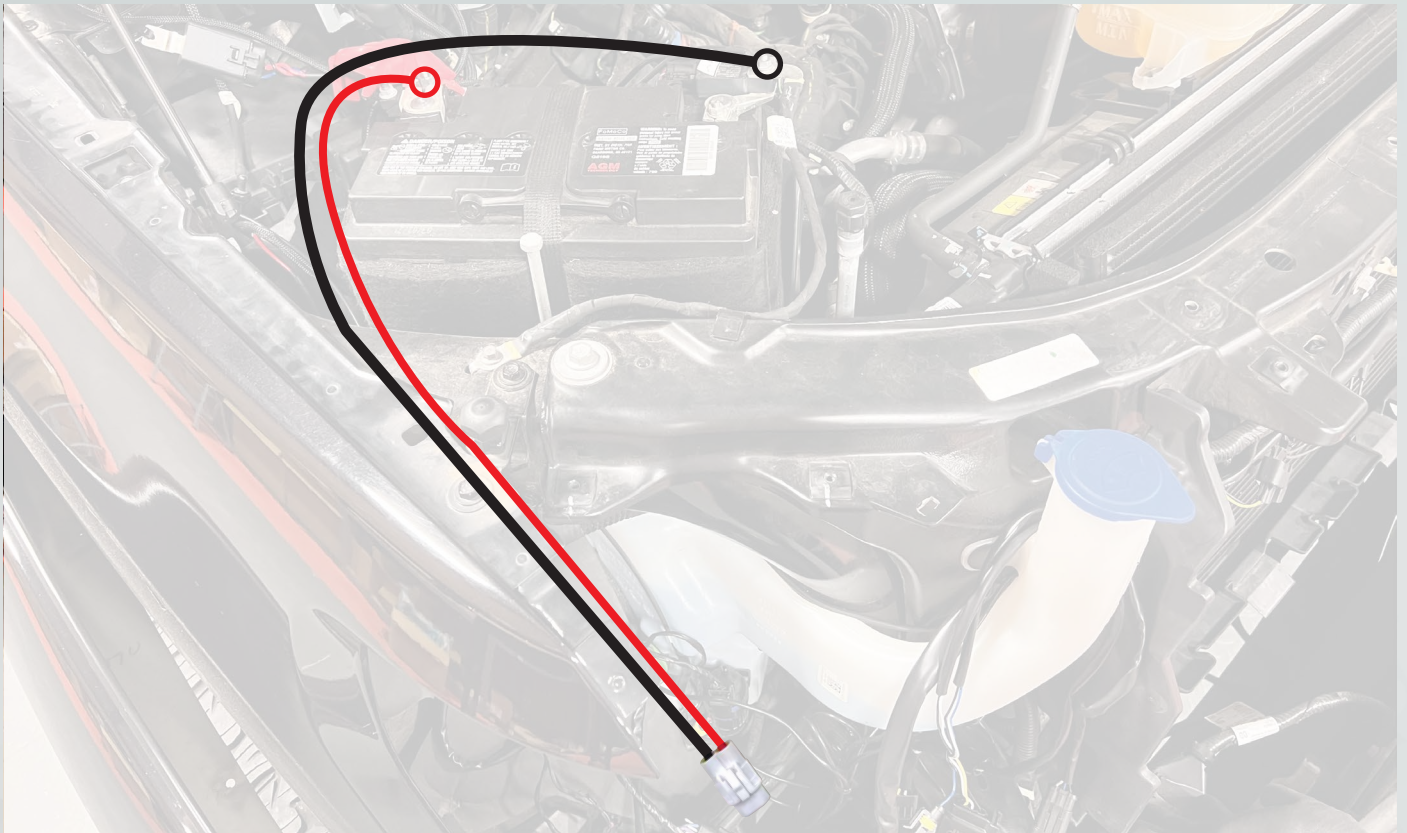

11. Locate the included Crossover Harness.

- Starting on the passenger side of the vehicle, place the end of the harness, that has 2 connectors, in the passenger headlight opening.
- Then route the other side of the harness to the driver side headlight opening.

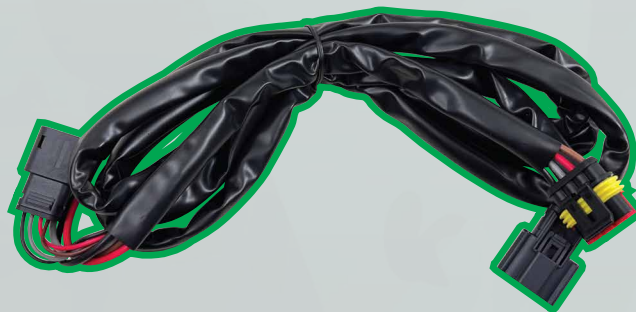

(HARNESS ROUTING)

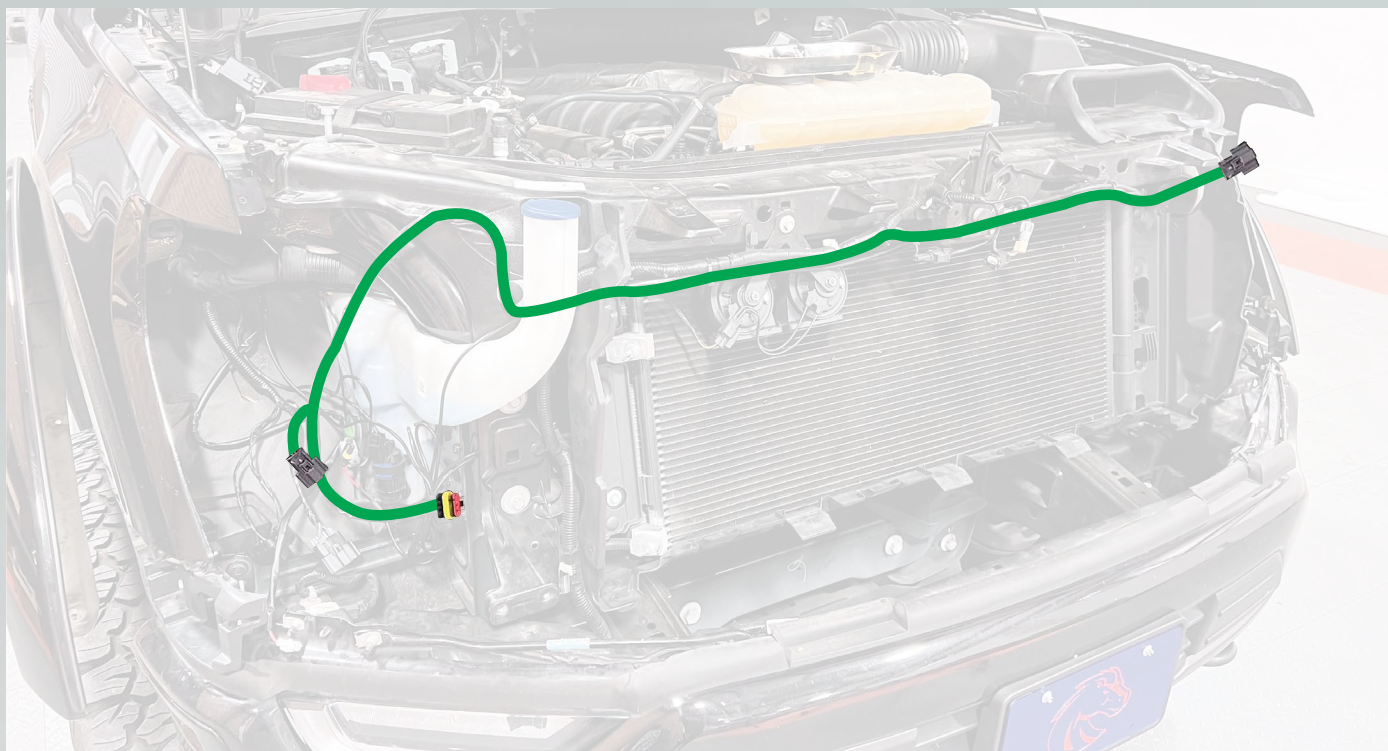

12. Unbox your Morimoto headlights and set them face down on a soft surface to not damage the lenses. First cut this ziptie holding the wires together and unplug the two (2) connectors (IMAGE 12). Next plug the two (2) connectors into each other (IMAGE 13). You will not need the capacitor that you removed.



IMAGE 12

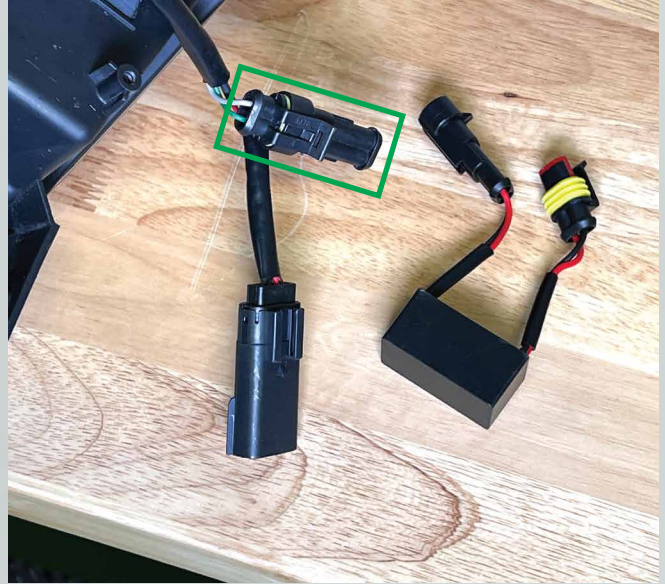

IMAGE 13

13. Locate the included Lin Bus Modules and screws. Install the Module labeled RH on the passenger side headlight in the location picture in (IMAGE 14) and secure it with two (2) philips head screws. Install the Module labeled LH on the driver side headlight in the location picture in (IMAGE 15) and secure it with two (2) philips head screws.

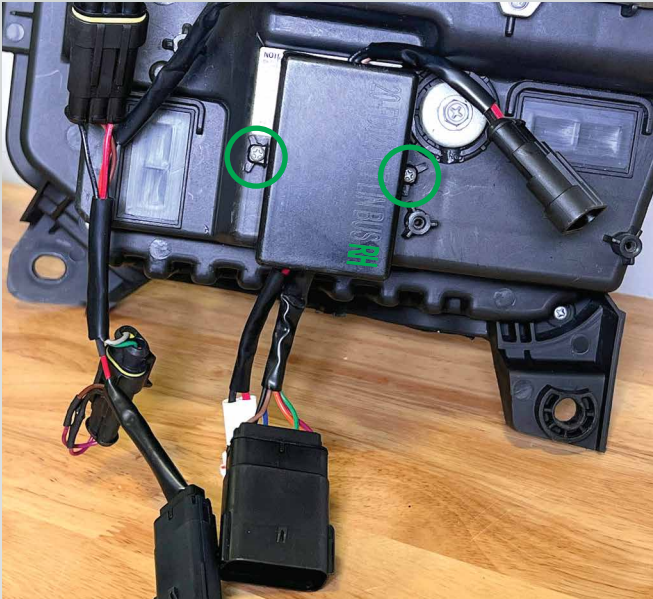

IMAGE 14

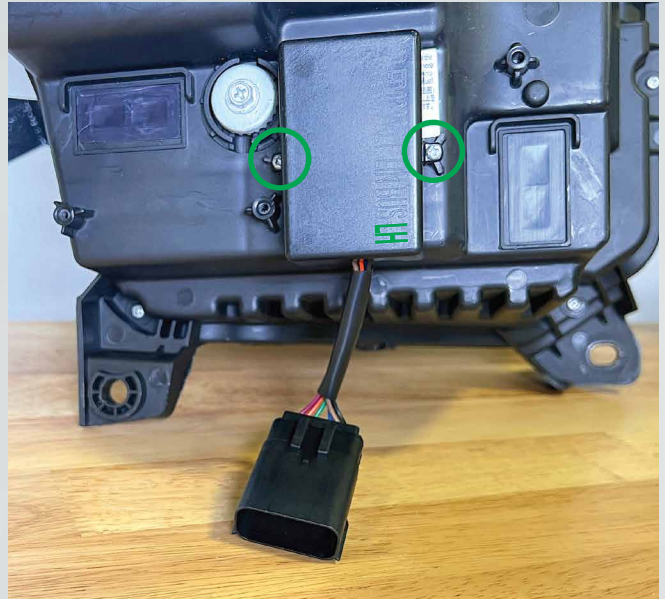

IMAGE 15

14. If you want to disable the parking light from lighting up in the fog light go to page 17. This can easily be done with the headlights removed, but can be done after from the fender well area.
15. Get the passenger side Morimoto headlight and take it to the truck. Start by plugging in these three (3) connectors (IMAGE 16). Select if you want a solid or sequential (scrolling) turn signal with the connector in (IMAGE 17). Leaving it plugged in will make it sequential, leaving it unplugged will make it flash solid.

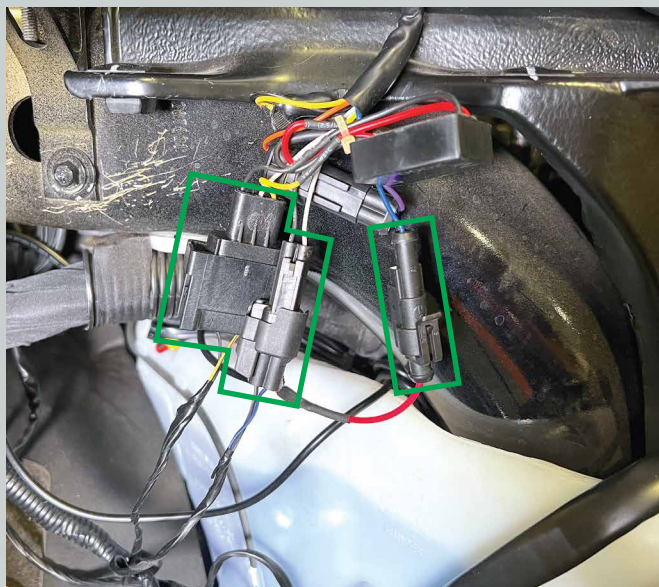

IMAGE 16

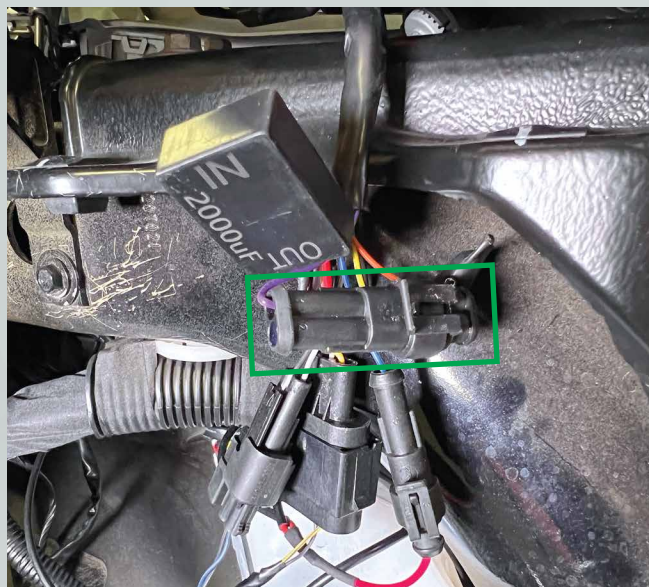

IMAGE 17

16. Plug in the two (2) Crossover Harness connectors (IMAGE 18). Next plug in the multi pin connector, and the Battery Harness connector (IMAGE 19).

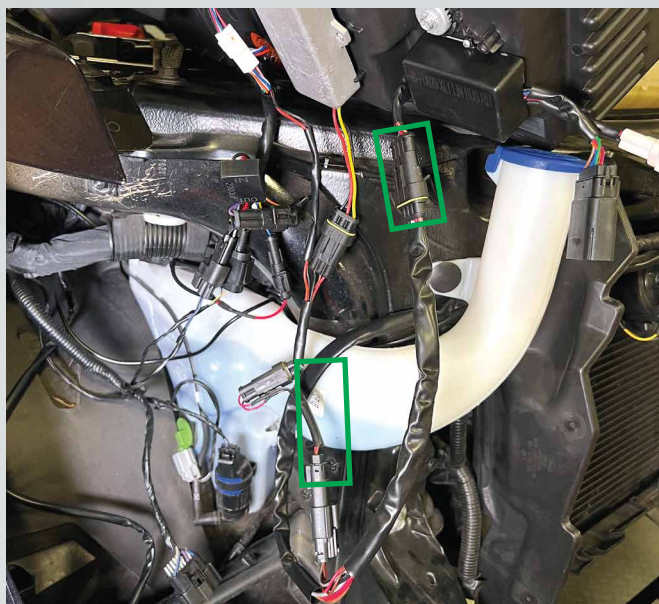

IMAGE 18

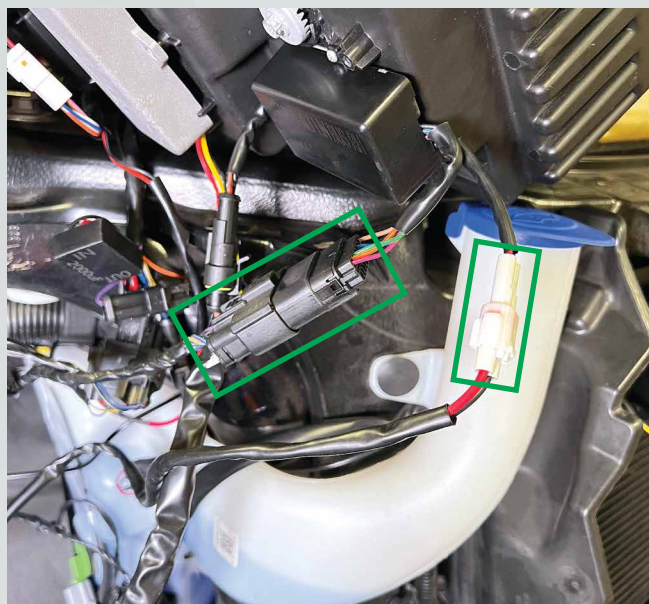

IMAGE 19

17. Slide the headlight into its mounting location making sure none of the wiring in the rear is getting pinched. Thread in the top bolts by hand.

18. Get the driver side Morimoto headlight and take it to the truck. Start by plugging in these three (3) connectors (IMAGE 20). Select if you want a solid or sequential (scrolling) turn signal with the connector in (IMAGE 21). Leaving it plugged in will make it sequential, leaving it unplugged will make it flash solid.

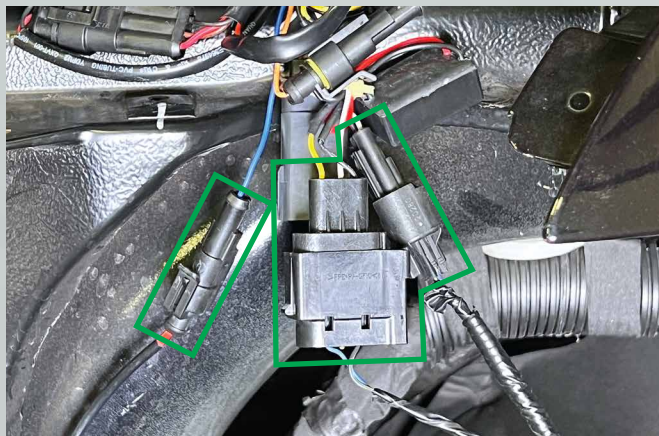

IMAGE 20

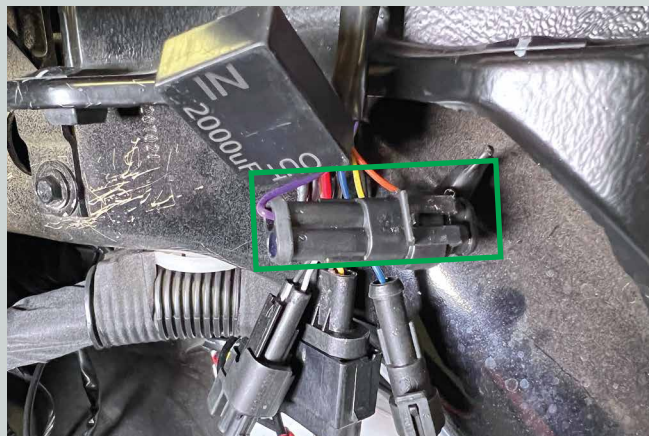

IMAGE 21

19. Plug in the Crossover Harness connector (IMAGE 22). Next plug in the multi pin connector (IMAGE 23).

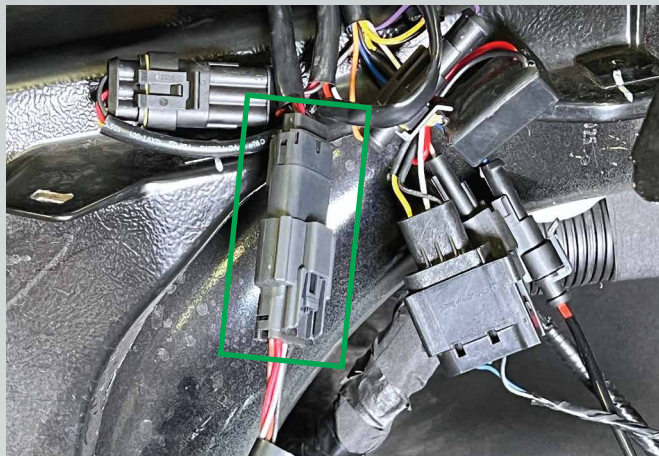

IMAGE 22

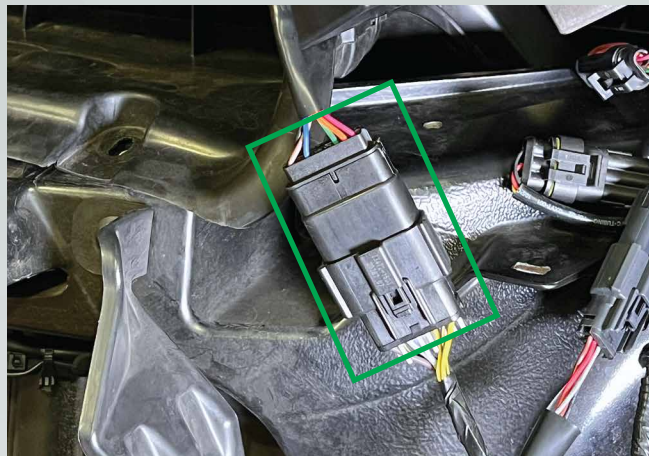

IMAGE 23

20. Place headlight in mounting position and thread in the top bolts by hand.

21. Turn the truck on and go through all of the functions.

22. Reassemble the truck in the reverse order that you took it apart.

PROCEED TO PAGE 15 FOR AIMING INSTRUCTIONS

23. Get the passenger side Morimoto headlight and take it to the truck. Start by plugging in these four (4) connectors (IMAGE 24). Select if you want a solid or sequential (scrolling) turn signal with the connector in (IMAGE 25). Leaving it plugged in will make it sequential, leaving it unplugged will make it flash solid.

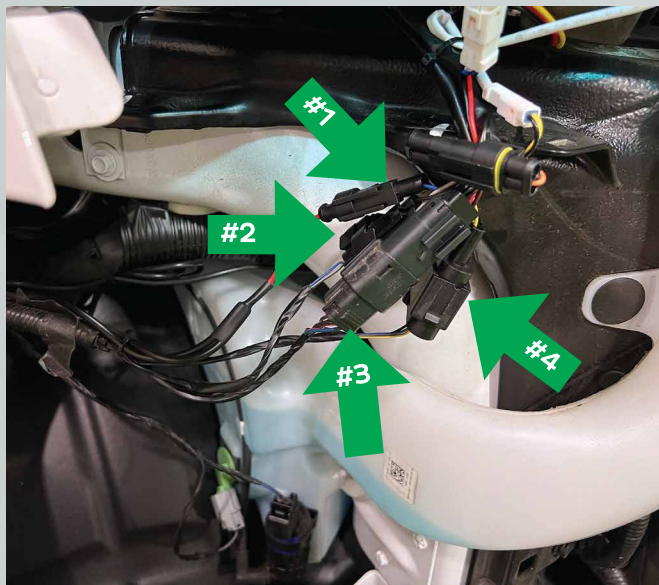

IMAGE 24

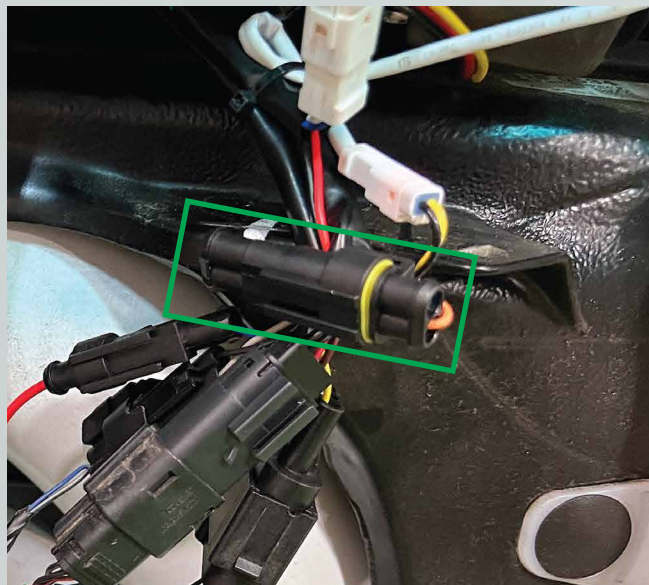

IMAGE 25

24. Place headlight in mounting position and thread in the top bolts by hand.

25. Repeat steps 23-24 on the other side of the truck.

26. Turn the truck on and go through all of the functions.

27. Reassemble the truck in the reverse order that you took it apart.

28. Follow these instructions to disable the OEM DRL. On your infotainment screen first press SETTINGS, then press GENERAL (IMAGE 20). Next scroll down then select LIGHTING (IMAGE 21).

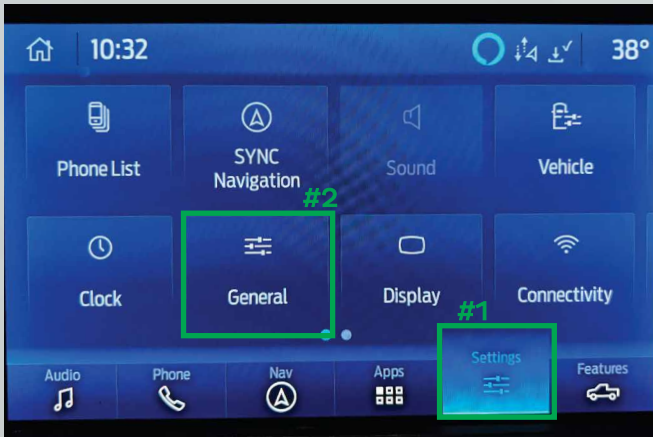

IMAGE 20



IMAGE 21

29. In the LIGHTING menu click the toggle beside DAYTIME RUNNING LIGHTS (IMAGE 22). To confirm the setting is off the screen will show DAYTIME RUNNING LIGHTS OFF at the top of the screen for a few seconds.



IMAGE 22



IMAGE 23

VERTICAL HEADLIGHT AIMING

27. To adjust the low beam, slide a philips head screwdriver into this slot and turn the screwdriver counter clockwise to move the beam up and turn clockwise to move the beam down.

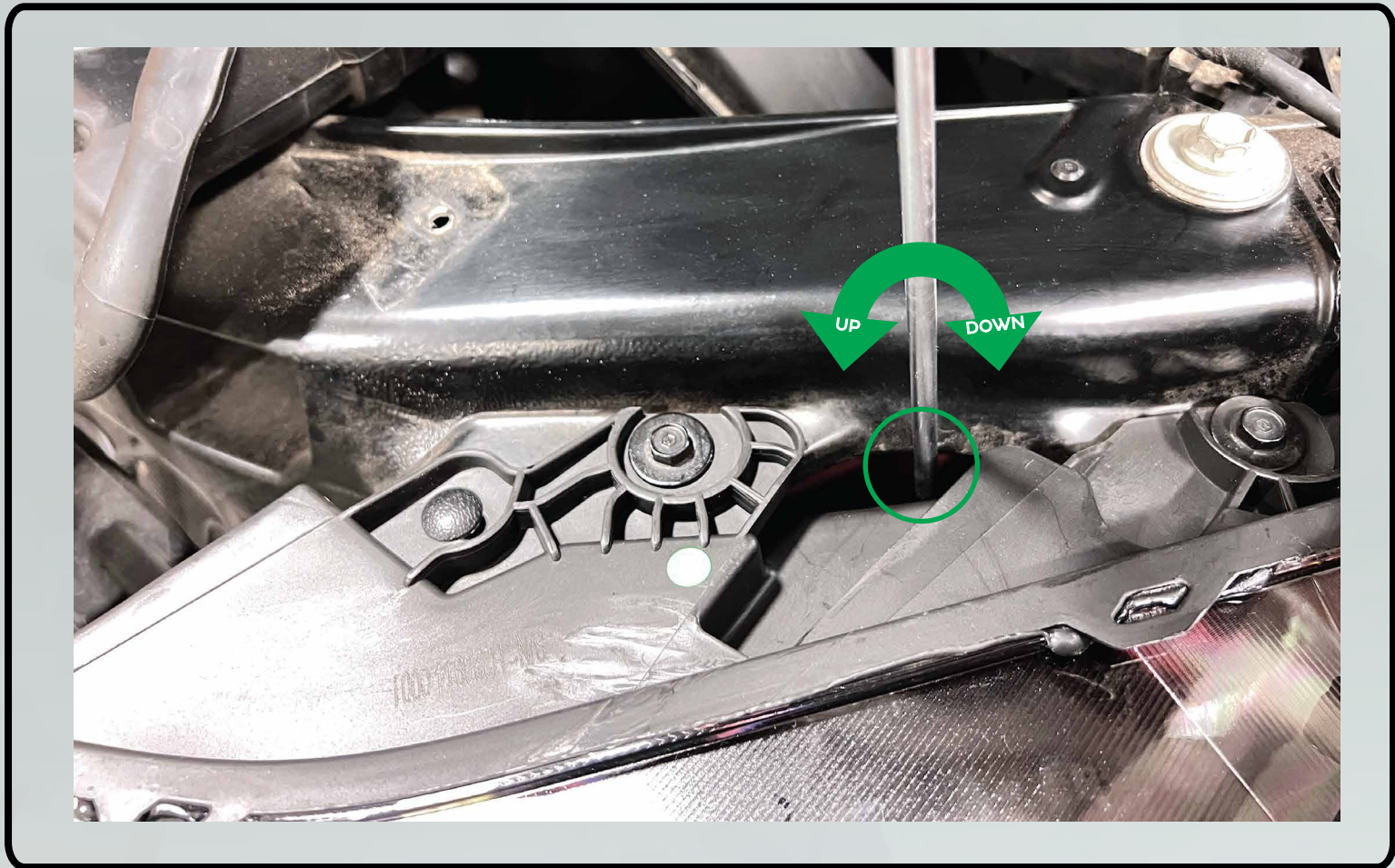

- Please refer to the aiming standards below when adjusting your headlight beam.

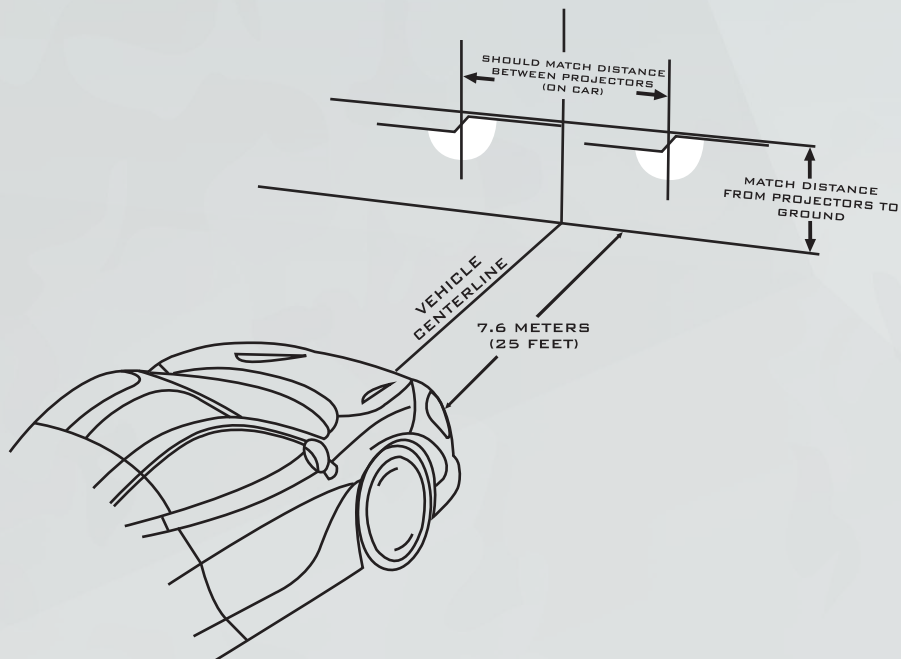

ENJOY YOUR NEW MORIMOTO XB HEADLIGHTS!

DISABLE DRL IN FOG LIGHT

(THIS PROCEDURE IS OPTIONAL)



BEFORE



AFTER

- Remove two (2) 7mm screws and a plastic clip in the fender liner and pull back the fender liner (IMAGE 24). Unplug the fog light (IMAGE 25).



IMAGE 24



IMAGE 25

- To depin the connector, get a straight pick and remove the white insert by prying it out of the connector via the slot (IMAGE 26).
- Stick the straight pick in the connector and pry the release tab up. While prying the release tab up, pull the wire from the back (IMAGE 27).
- Reinstall the white insert, and wrap the pin you just pulled out with electrical tape (IMAGE 28).



IMAGE 26

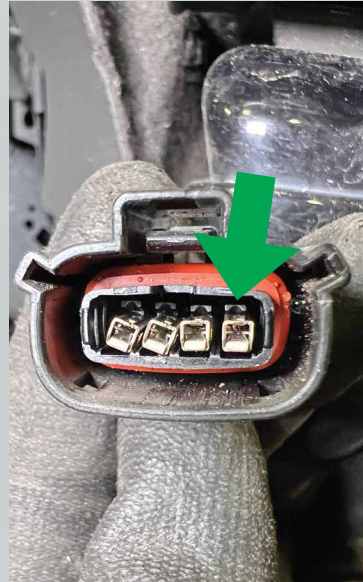

IMAGE 27

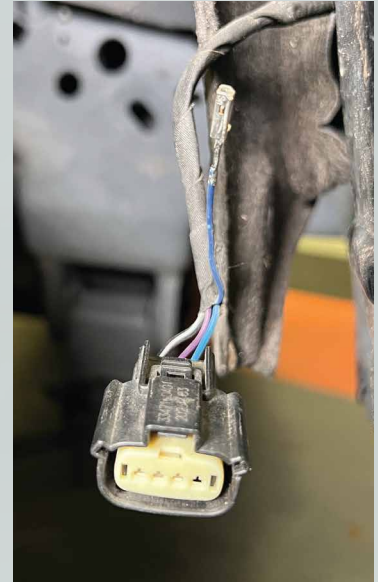

IMAGE 28

- Repeat the previous two steps on the other side of the truck.
- Turn the truck on and go through all of the functions.
- Reassemble the truck in the reverse order that you took it apart.