



THE AUTOMOTIVE LIGHTING BENCHMARK

# 2020-22 SUPERDUTY XB LED GRILLE INSTALL GUIDE

**WARNING:** By reading this document, you agree it is only to be used as an educational guide. Morimoto Lighting nor its dealers make guarantees on any finished results, nor are they to be held responsible for any damage, misuse, or personal injuries. If you are unable to clearly understand and adapt the information below, professional installation is recommended.

## PACKAGE CONTENTS

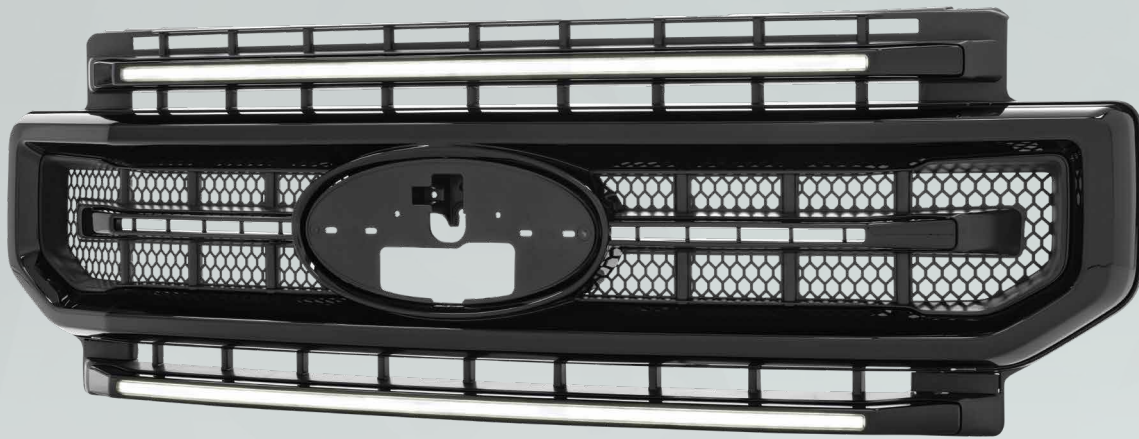

1X XBG GRILLE



1 X FUSE TAP / DRL HARNESS



1X HALOGEN ADAPTER HARNESS



1 X 15A FUSE



2 X BOLT COVERS



1X OEM LED ADAPTER HARNESS



6 X EMBLEM DAMPENERS



2 X 10MM NUTS

# 2020-2022 FORD SUPERDUTY



## TABLE OF CONTENTS

- VERTICAL HEADLIGHT AIMING PROCEDURE .....	PAGE 3
- GRILLE AND HEADLIGHT REMOVAL .....	PAGE 4
- OEM HEADLIGHT IDENTIFIER .....	PAGE 12
- INSTALL ON A HALOGEN TRUCK .....	PAGE 13
- INSTALL ON A OEM LED TRUCK W/ MORIMOTO HEADLIGHTS .....	PAGE 17
- INSTALL ON A OEM LED TRUCK W/ OEM LED HEADLIGHTS .....	PAGE 24

## REQUIRED TOOLS

- |               |  |
|---------------|--|
| - RATCHET     | - FLAT HEAD SCREWDRIVER OR TRIM REMOVAL TOOL |
| - 10MM SOCKET | - PHILIPS HEAD SCREWDRIVER                   |
| - 13MM SOCKET | - NEEDLE NOSE PLIERS                         |
| - PICK TOOL   | - TAPE MEASURE                               |

# VERTICAL HEADLIGHT AIMING PROCEDURE

- First park your truck on a level surface 25 feet from a wall.
- Then with a tape measure, measure the distance between the ground and your headlight beam (picture below).
- Write down this measurement.
- Once you install your Morimoto headlights, park the same way as you did with your previous headlights
- Aim your Morimoto headlights to shine as high as your previous headlight (measure ment you too above).
- The general rule is to then drive the truck around and look at surrounding vehicles to make sure your headlight beam isn't directly in their eyes, if it is then lower your headlights. (this may vary depending on how high your truck is from the ground)

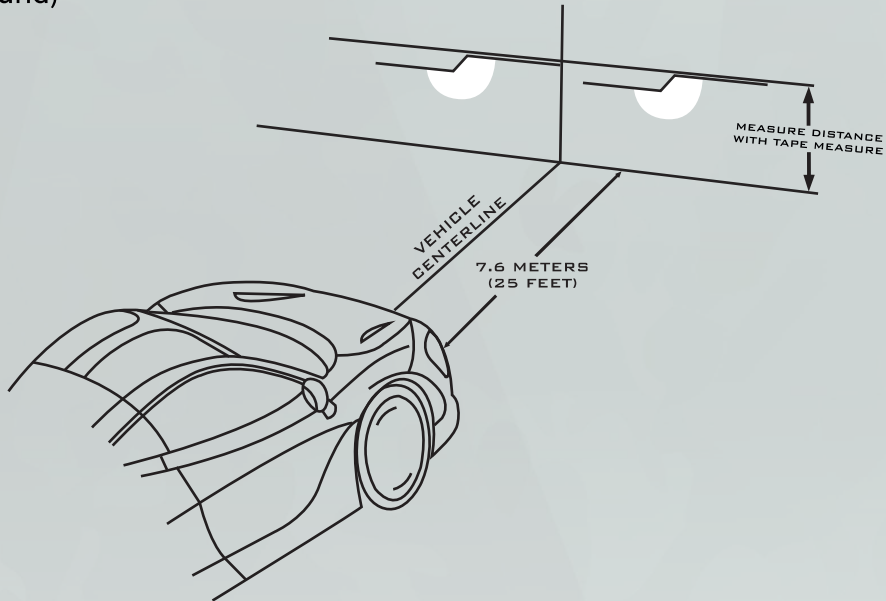

- To adjust the low beam, slide a philips head screwdriver into this slot and turn the screwdriver counter clockwise to move the beam up and turn clockwise to move the beam down.



# INSTALLATION PROCESS

1. Remove the fourteen (14) plastic clips holding on the grille cover. Then remove the cover off the truck.



2. Remove the six (6) 10mm bolts holding the top of the grille.

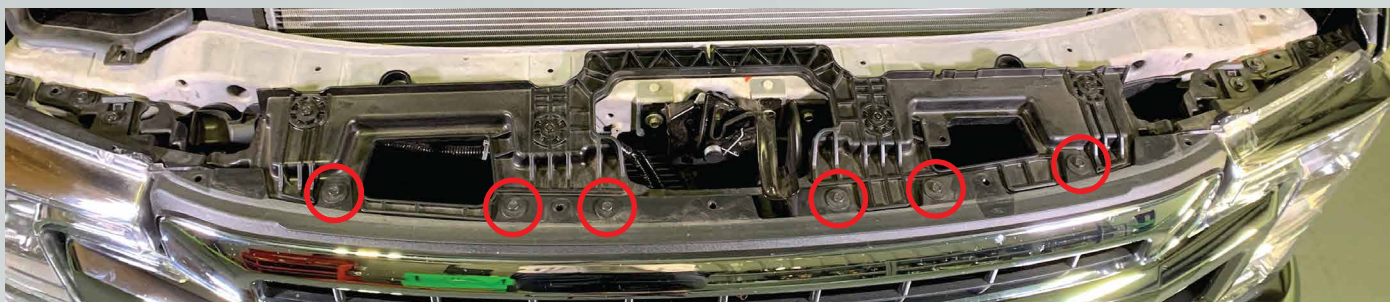

3. Remove one (1) 10mm nut holding the grille to the headlight. Repeat on the other side of the grille.



4. To remove the bottom chrome trim piece on the grille, grab a pick and pry down on these locking tabs. While releasing the locking tabs slowly start prying out on the trim piece so it doesn't lock back into place. Repeat on the other side of the grille.

**(IF YOU DO NOT HAVE THIS KIND OF GRILLE SKIP TO PAGE 7 FOR FURTHER INSTRUCTION)**



5. With a plastic pry tool carefully pry the chrome trim away from the grille to release all of the clips.



- Here is a top view picture of the chrome trim piece off of the truck, so you can reference all of the clips.



6. Remove these two (2) 10mm bolts that secure the bottom of the grille.



If you have this style of grille, complete the following steps. If not then skip to step #9.



7. Take a pry tool, and pry this flap towards the middle of the grille. Repeat this on the other side of the grille.



8. Once the flap is off, remove the 10mm bolt. Repeat this on the other side of the grille.



9. Pry the grille forward in this spot to release the clips.

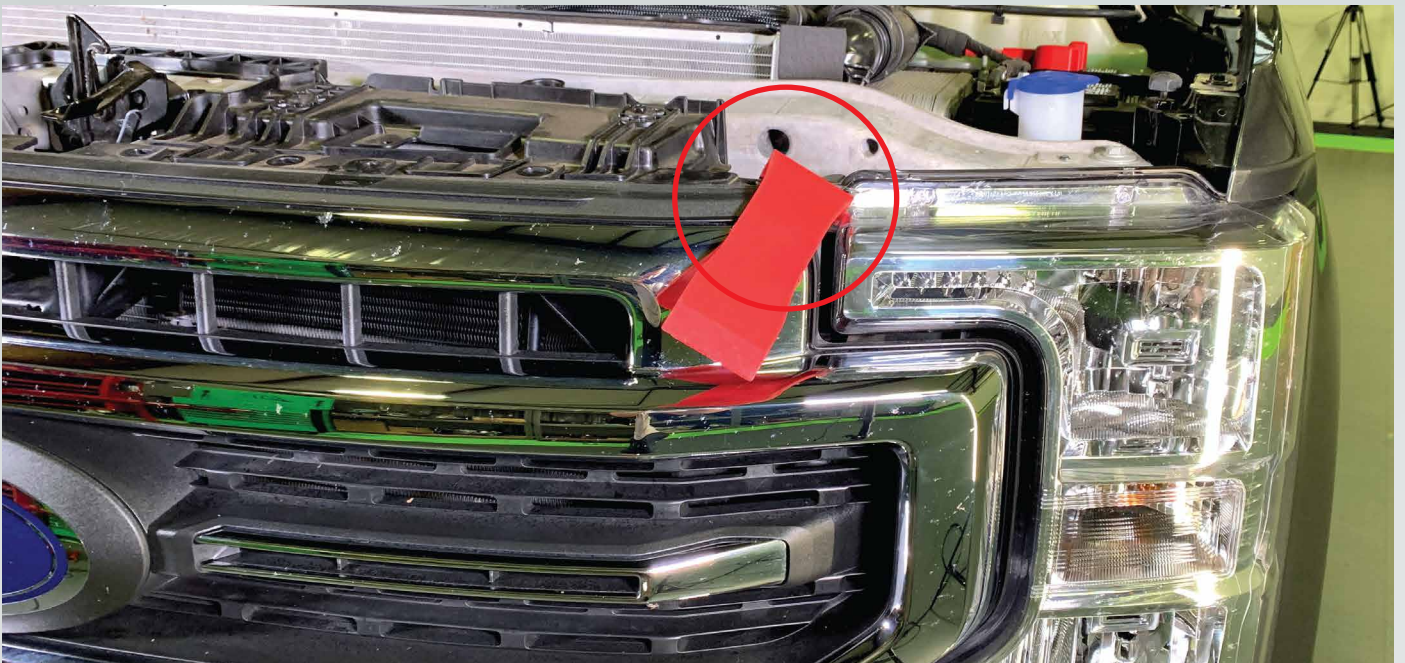



10. Pry the grille forward in this spot to release the clips.



11. Repeat step #9-10 on the other side of the grille.

12. With the grille angled forward, take a flat screwdriver and press these four (4) metal clips down to release the bottom of the grille. Now you can remove the grille off of the truck.

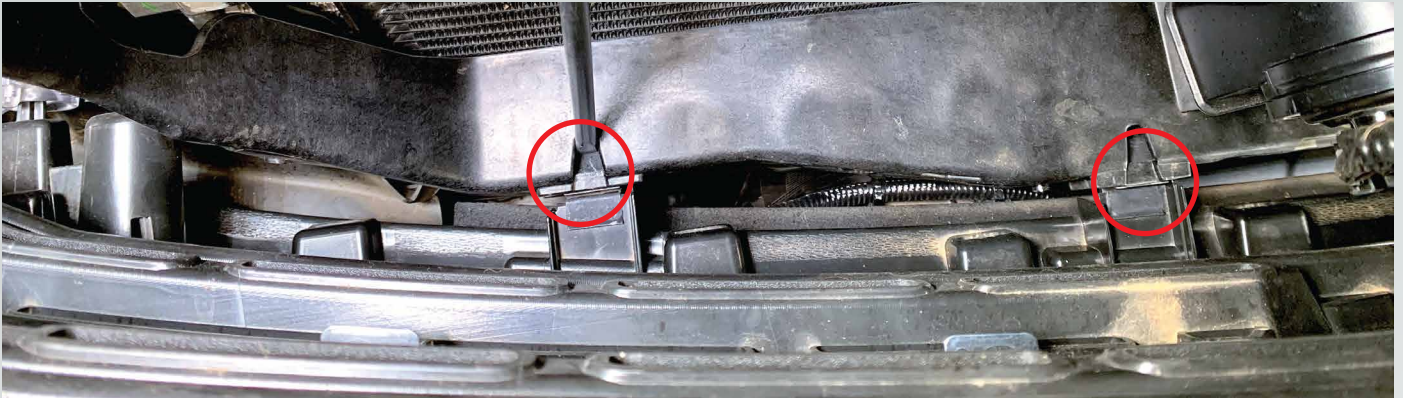

13. If you have a front camera, unplug the connector on the camera by pressing the release tab and sliding the connector off. Then disconnect the washer fluid hose fitting by prying up on one side of the locking collar then slide the hose fitting off (A few drops of washer fluid may come out.). Now pull the grille off of the truck and set it aside.



14. Remove one (1) 13mm bolt holding the bottom tab of the passenger side headlight to the fender (IMAGE 1). Remove two (2) 10mm bolts holding the top of the headlight (IMAGE 2).

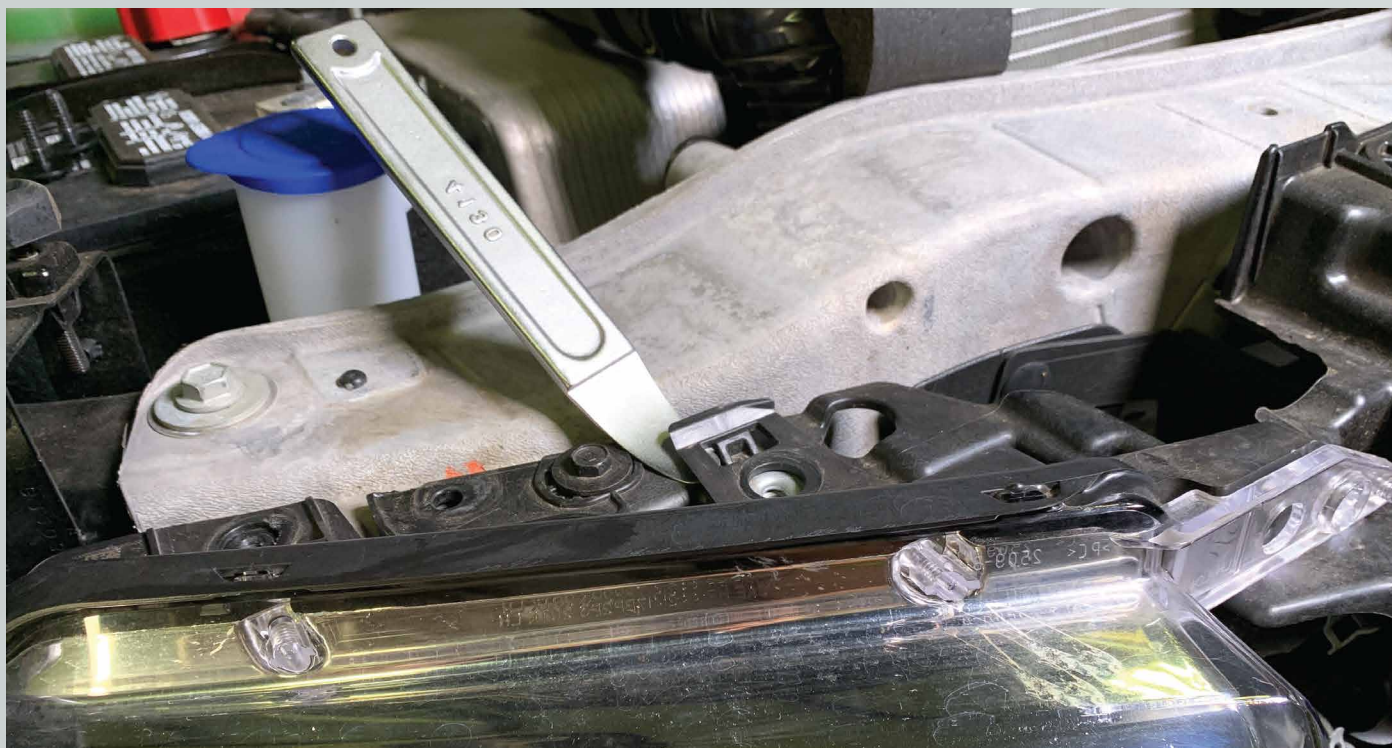

IMAGE 1

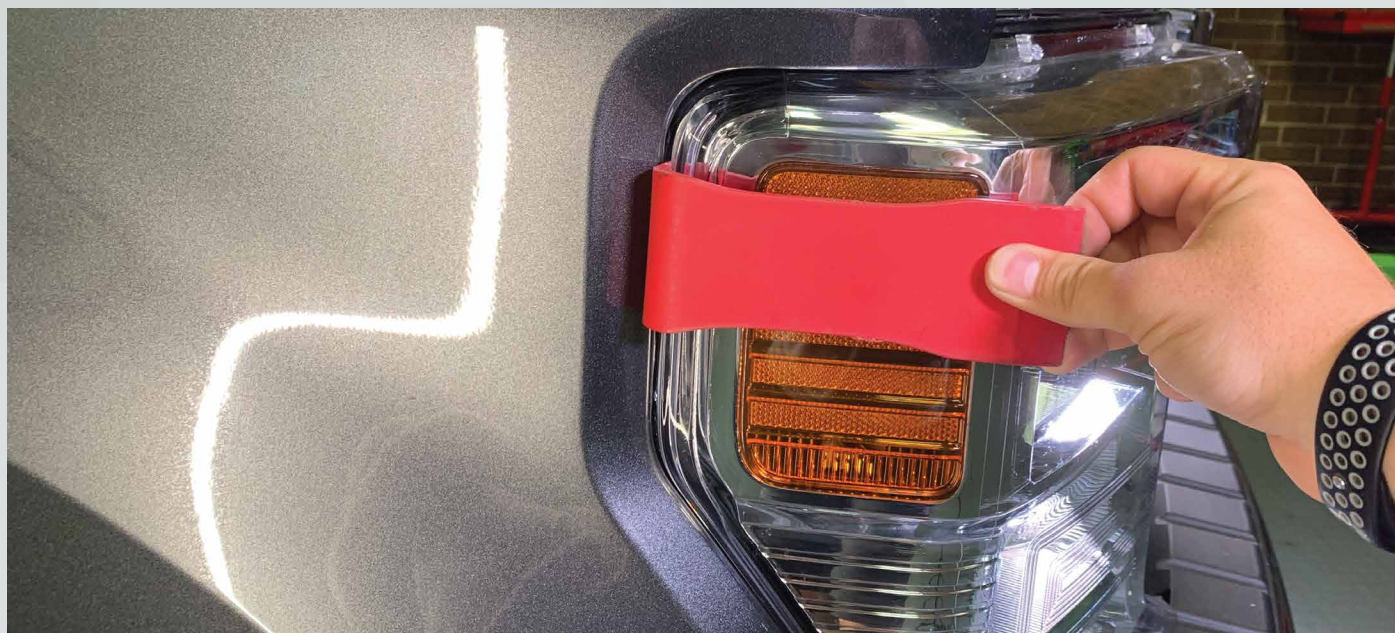

IMAGE 2

15. Pry up on this tab to release the top of the headlight.



16. With a plastic pry tool, pry the side of the headlight away from the fender to release it.



# OEM HEADLIGHT IDENTIFIER



OEM HALOGEN (PROCEED TO PAGE 13)



OEM LED (PROCEED TO PAGE 17)

17. Slide the headlights forward. Unplug the four (4) connectors (IMAGE 17.a). Locate the included Fuse Tap DRL harness (the one included with the headlight) and remove the 10A fuse shown in IMAGE 17.b. Replace that fuse with the 15A fuse included with your Morimoto grille (IMAGE 17.c).

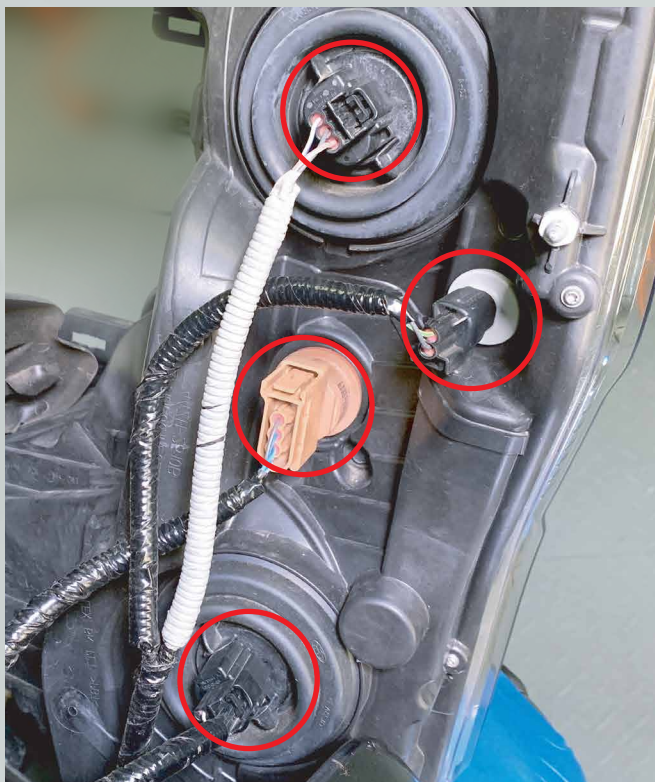

IMAGE 17.a

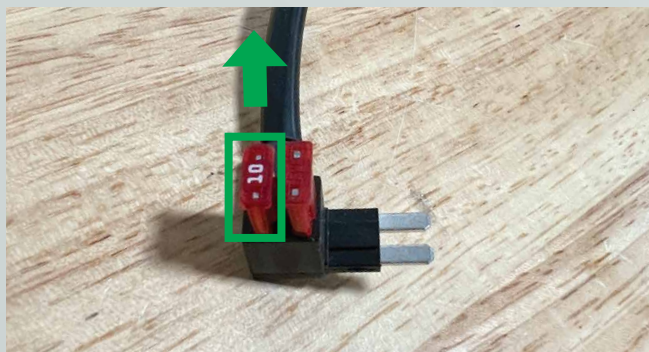

IMAGE 17.b

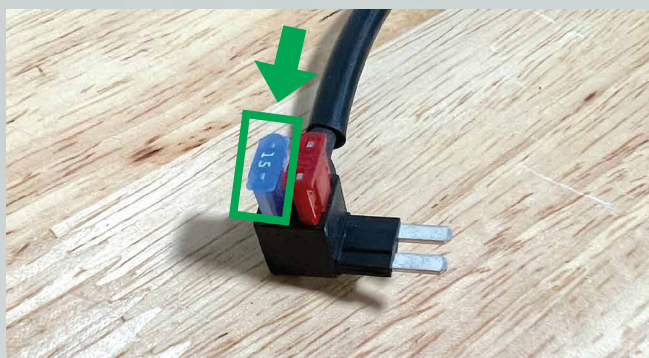
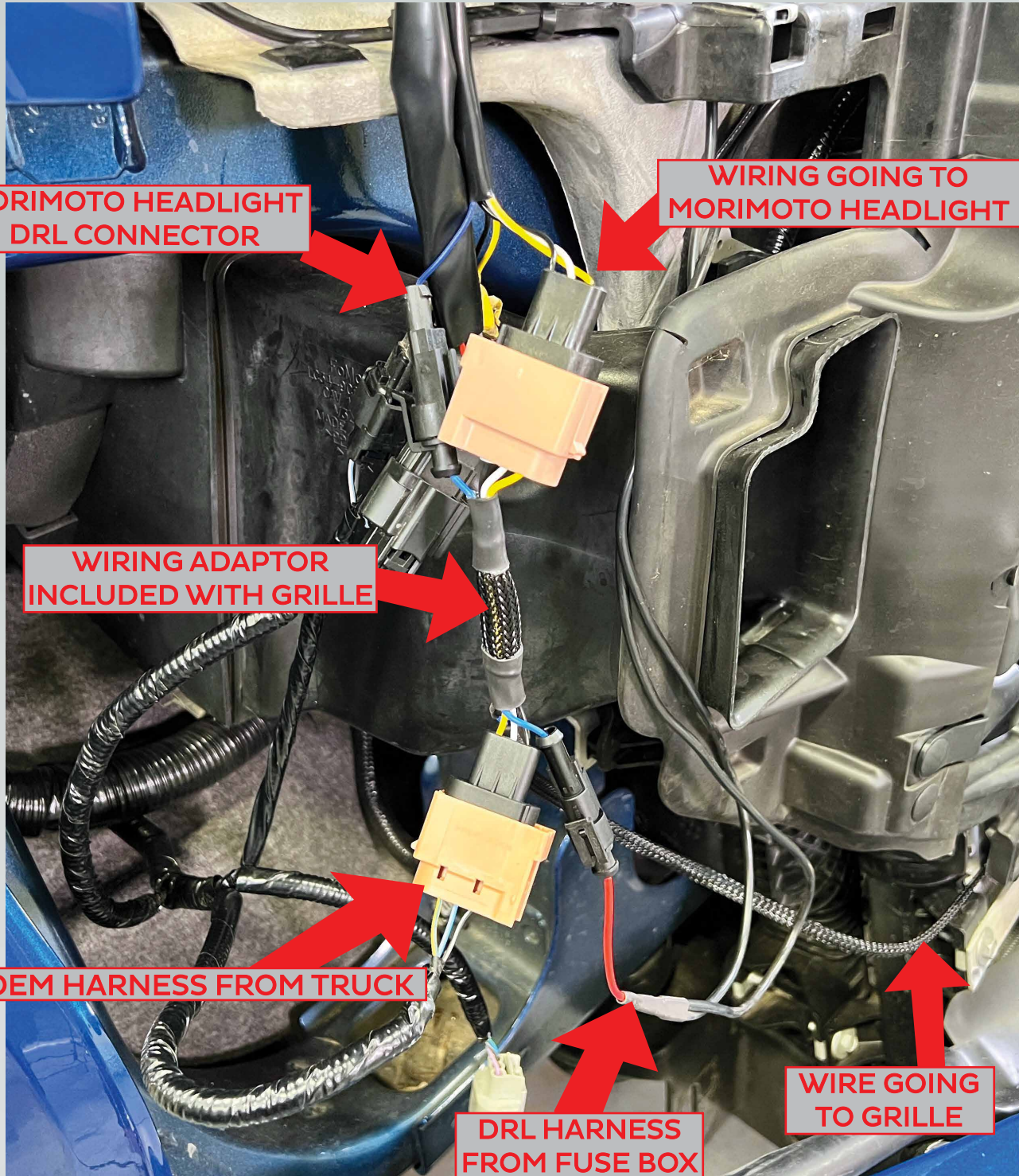

IMAGE 17.c

18. Locate the under hood fuse box located by the firewall on the passenger side of the truck and remove the cover. Remove fuse #16. Get the DRL harness from the previous step. Plug in the fuse side of the harness into fuse slot #16. Run the short side of the harness to the passenger headlight area and run the long side to the driver headlight area.



19. Locate the Halogen Adaptor Harness that is included with the grille.
- On the passenger side of the truck, plug in the adaptor into your truck wiring and the DRL harness.
  - Route the grille wiring toward the center of the grille.
  - Plug in the passenger side Morimoto XB headlight into the Halogen Adaptor Harness.



**OEM HALOGEN TRUCK USING MORIMOTO XB HEADLIGHTS**

20. Plug in the other two (2) connectors, coming from your Morimoto headlight, into the truck wiring.

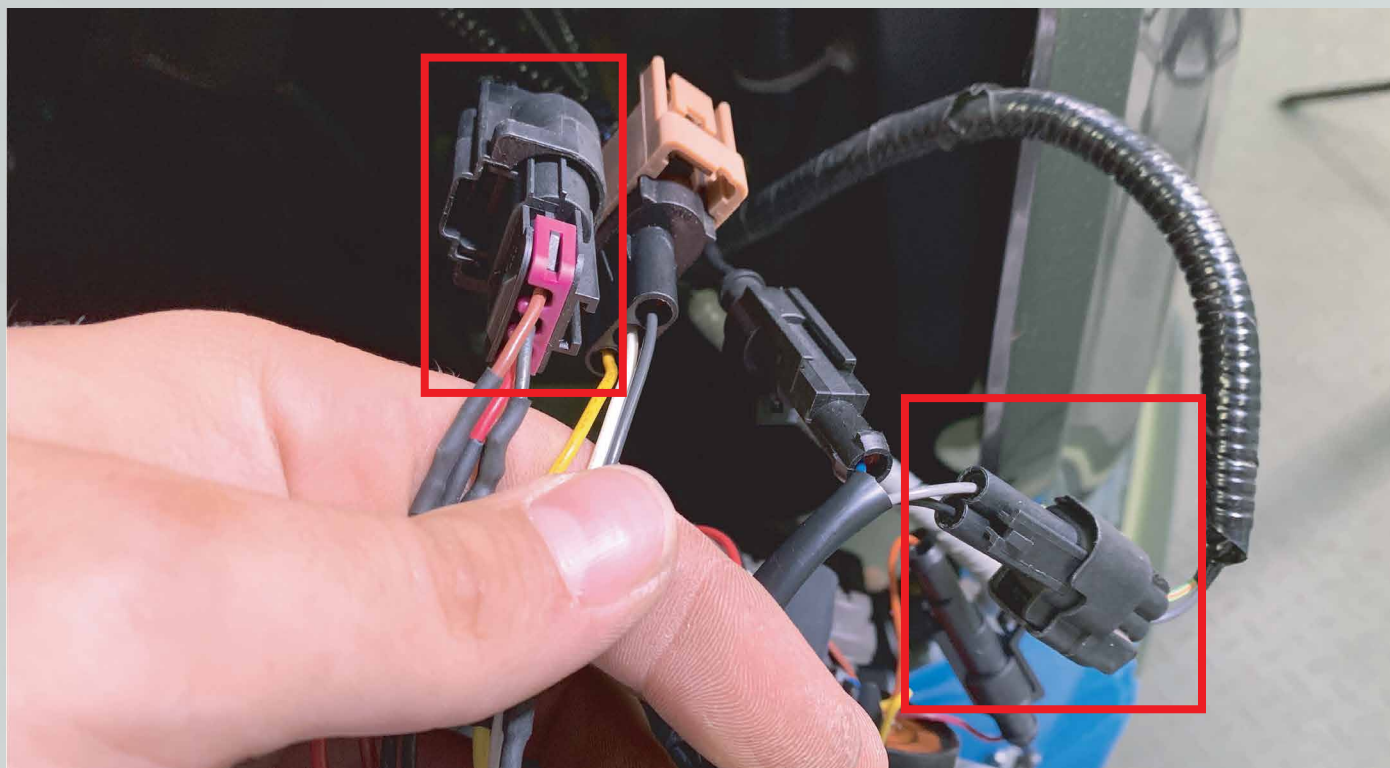

21. Toggle between standard and sequential turn signal with this connector. Leave the connectors plugged in for a sequential turn signal. Leave the connectors unplugged for a standard turn signal.

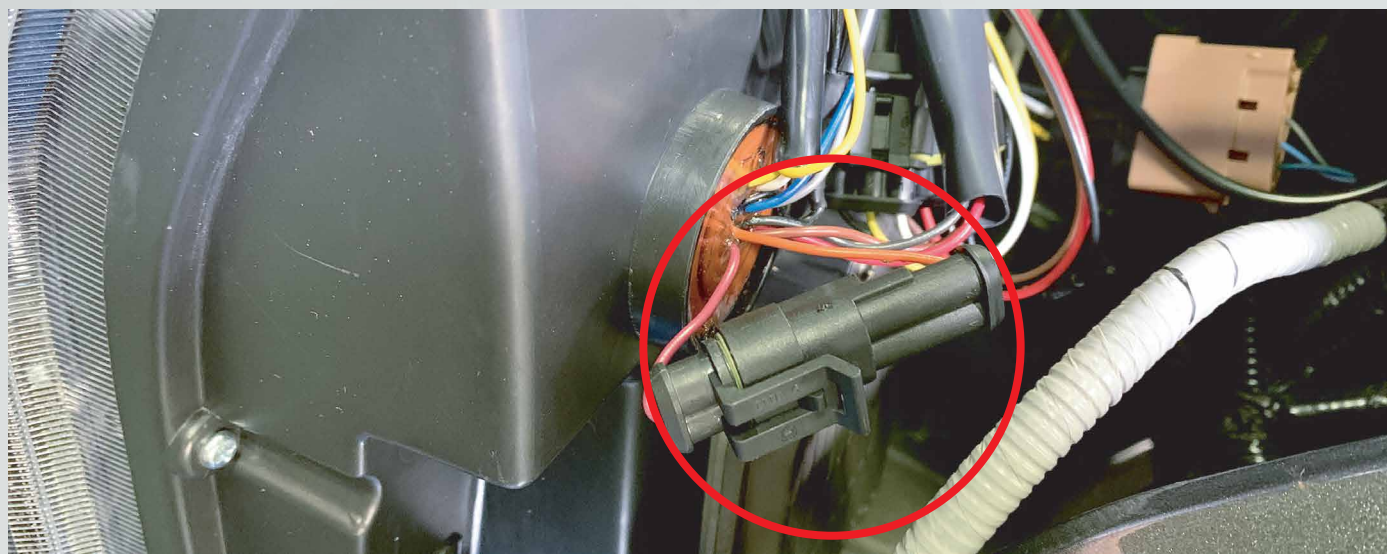

22. Place the headlight in it's place on the truck and thread in the bolts.

23. Repeat step# 14-17 on the driver side of the truck.

24. Get your driver side Morimoto XB headlight and make these four (4) connection between the headlight and the vehicle harness.

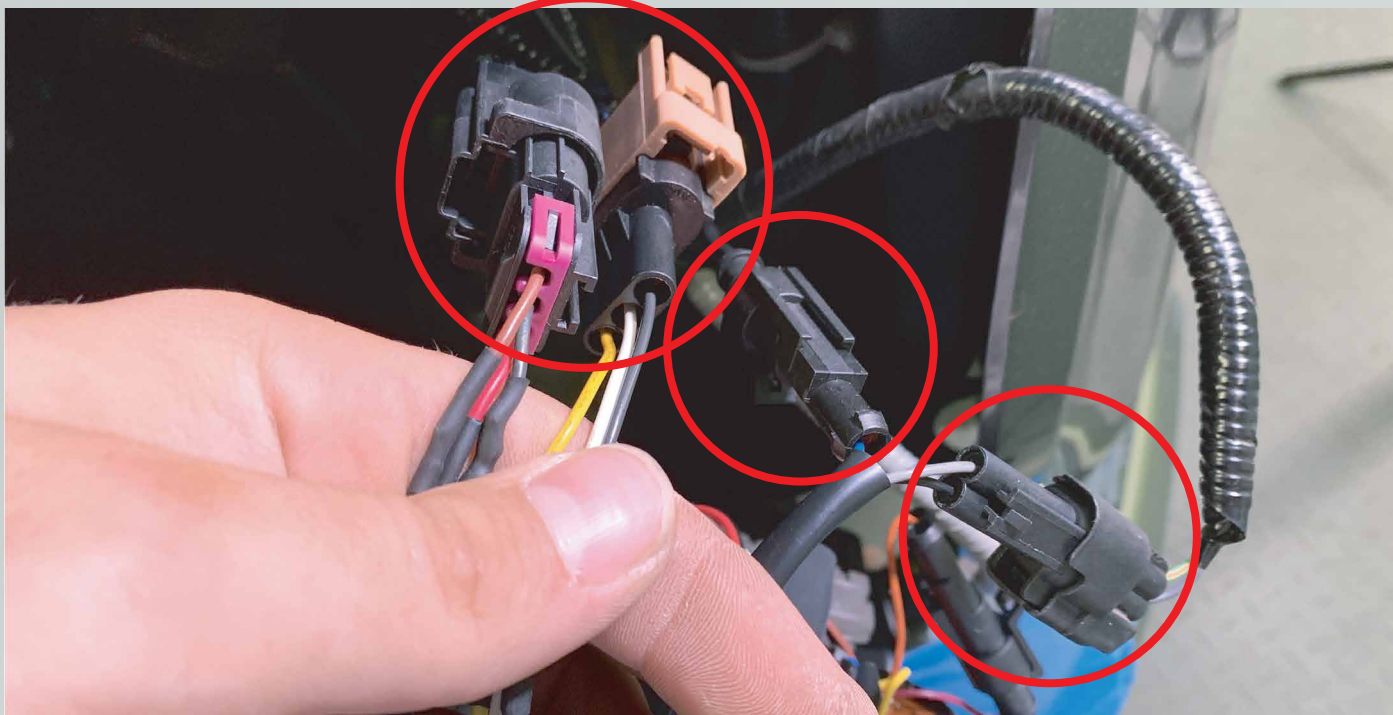

25. Toggle between standard and sequential turn signal with this connector. Leave the connectors plugged in for a sequential turn signal. Leave the connectors unplugged for a standard turn signal.

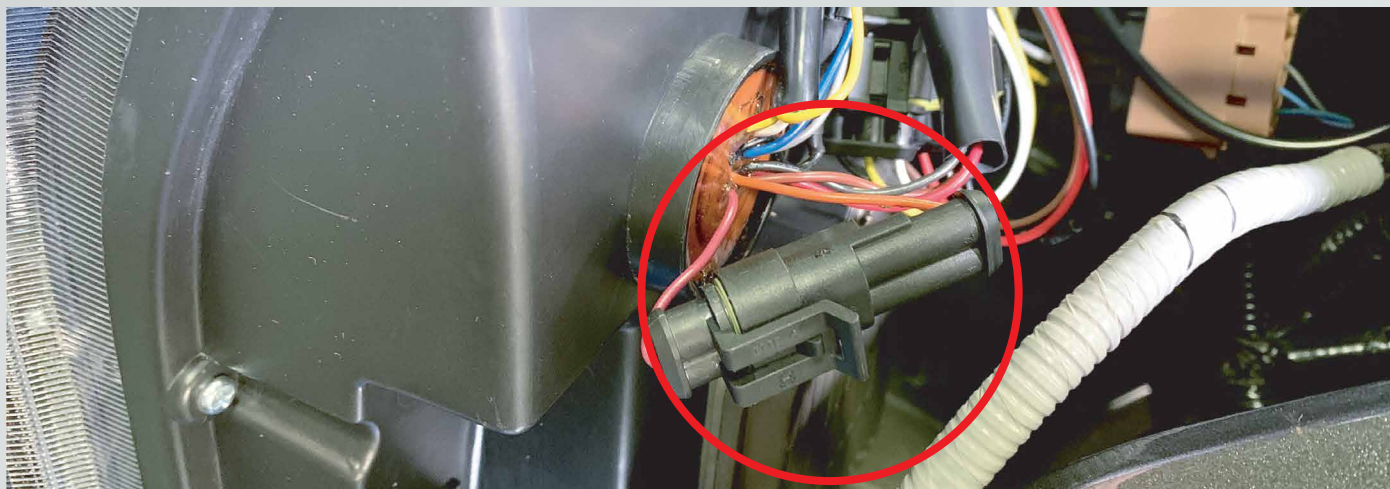

26. Place the headlight in it's place on the truck and thread in the bolts.

**SKIP TO PAGE 26 TO CONTINUE THE INSTALL**



# INSTALL ON OEM LED TRUCK W/ MORIMOTO XB HEADLIGHTS



## PACKAGE CONTENTS (IF ORDERED OPTIONAL LF508H-LED HARNESS)



2 X LIN BUS MODULE



1 X CROSSOVER HARNESS



1 X BATTERY HARNESS

INSTALL ON OEM LED TRUCK WITH KEEPING YOUR  
OEM LED HEADLIGHTS SKIP TO PAGE 24

27. Complete steps #1-16. Slide the passenger headlight forward. Unplug the multi pin connector (IMAGE 27.a), and repeat on the other side of the truck. Locate the included Fuse Tap DRL harness (the one included with the headlights) and remove the 10A fuse shown in IMAGE 27.b. Replace that fuse with the 15A fuse included with your Morimoto grille (IMAGE 27.c).

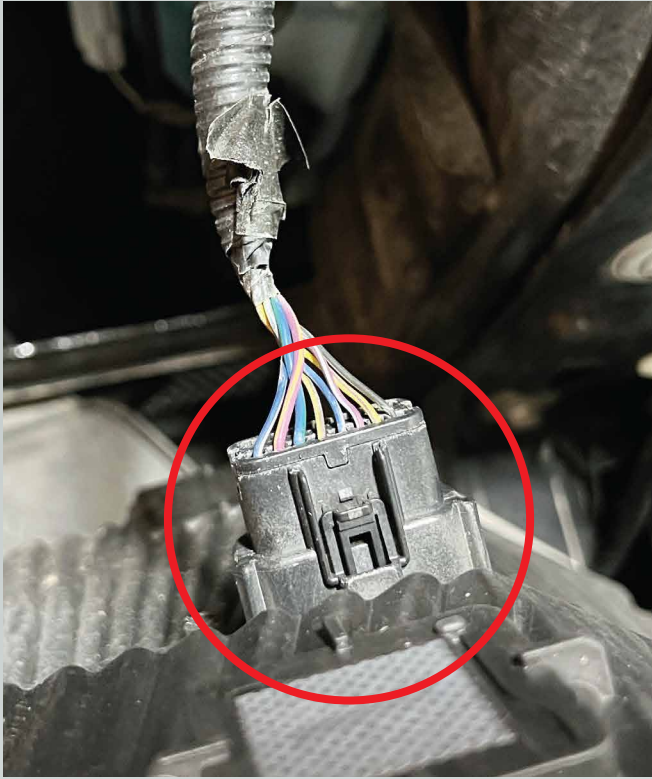

IMAGE 27.a

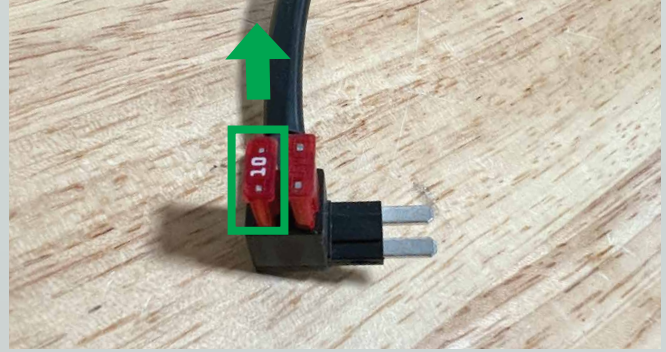

IMAGE 27.b

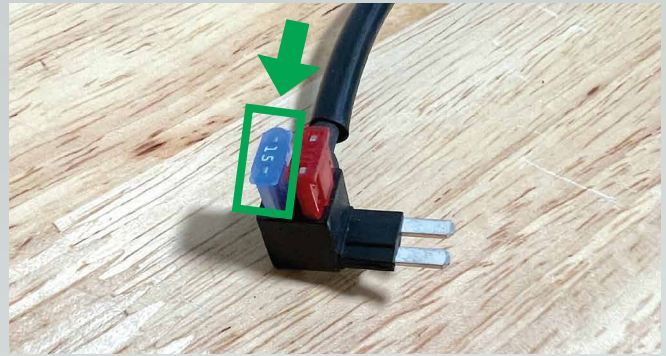
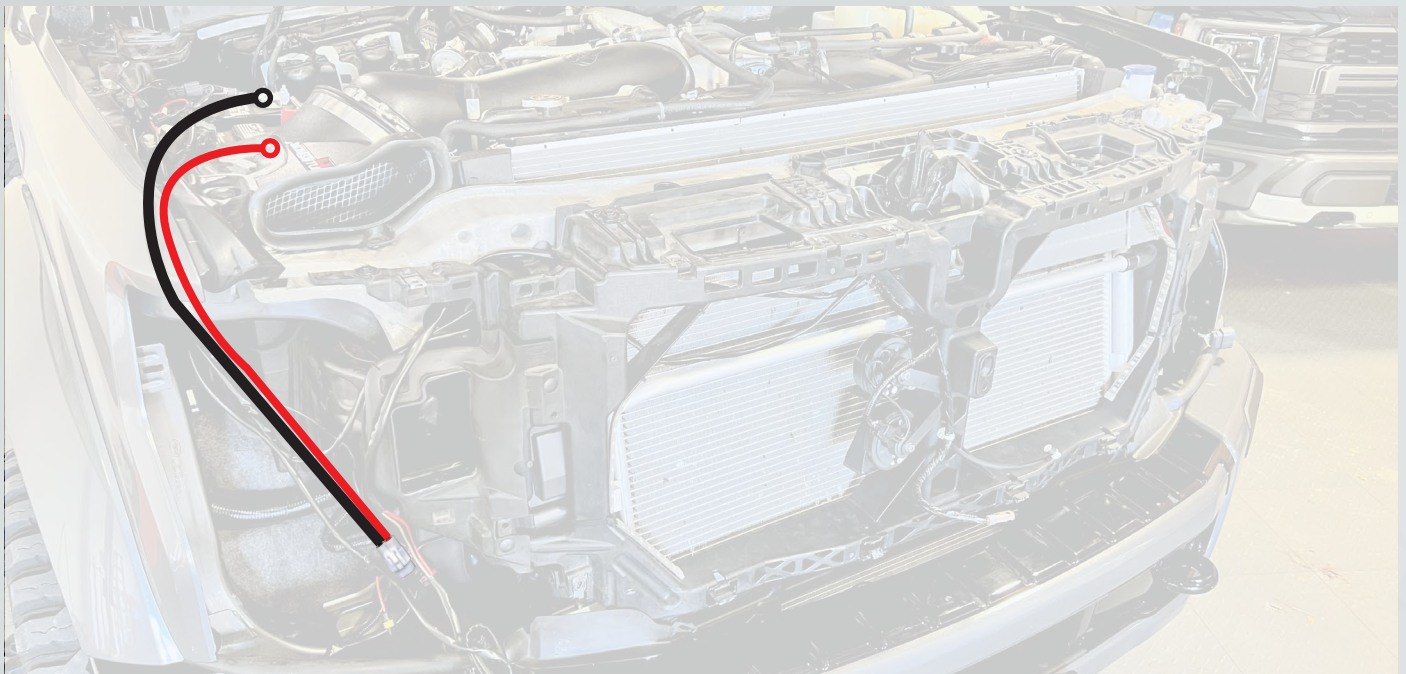
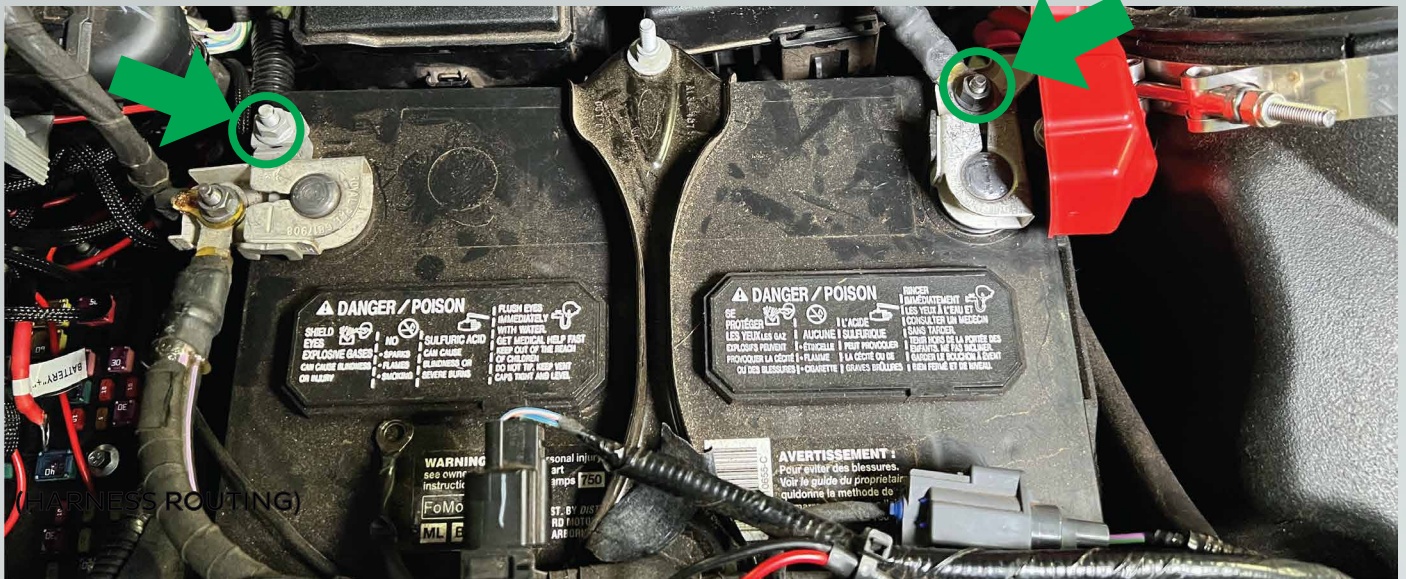
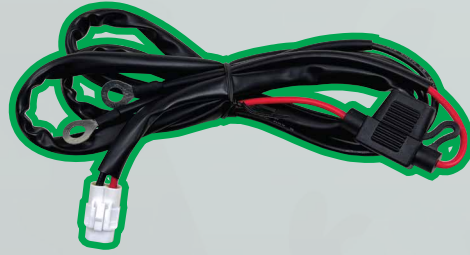

IMAGE 27.c

28. Locate the under hood fuse box located by the firewall on the passenger side of the truck and remove the cover. Remove fuse #16. Get the DRL harness from the previous steep. Plug in the fuse side of the harness into fuse slot #16. Run the short side of the harness to the passenger headlight area and run the long side to the driver headlight area.



29. -Locate the included Battery Harness, go to the battery and remove the 10mm nut on the positive terminal. Install the positive lead (red wire) onto the stud on the positive terminal, and reinstall the 10mm nut.  
-Install the negative lead from the Battery Harness (black wire). Remove the 10mm nut on the negative terminal, install the negative lead (black wire) and reinstall the 10mm nut.  
-Run the other end of the Battery Harness to the passenger side headlight opening.



30. Locate the included Crossover Harness.

- Starting on the passenger side of the vehicle, place the end of the harness, that has 2 connectors, in the passenger headlight opening.
- Then route the other side of the harness to the driver side headlight opening.



**(HARNESS ROUTING)**

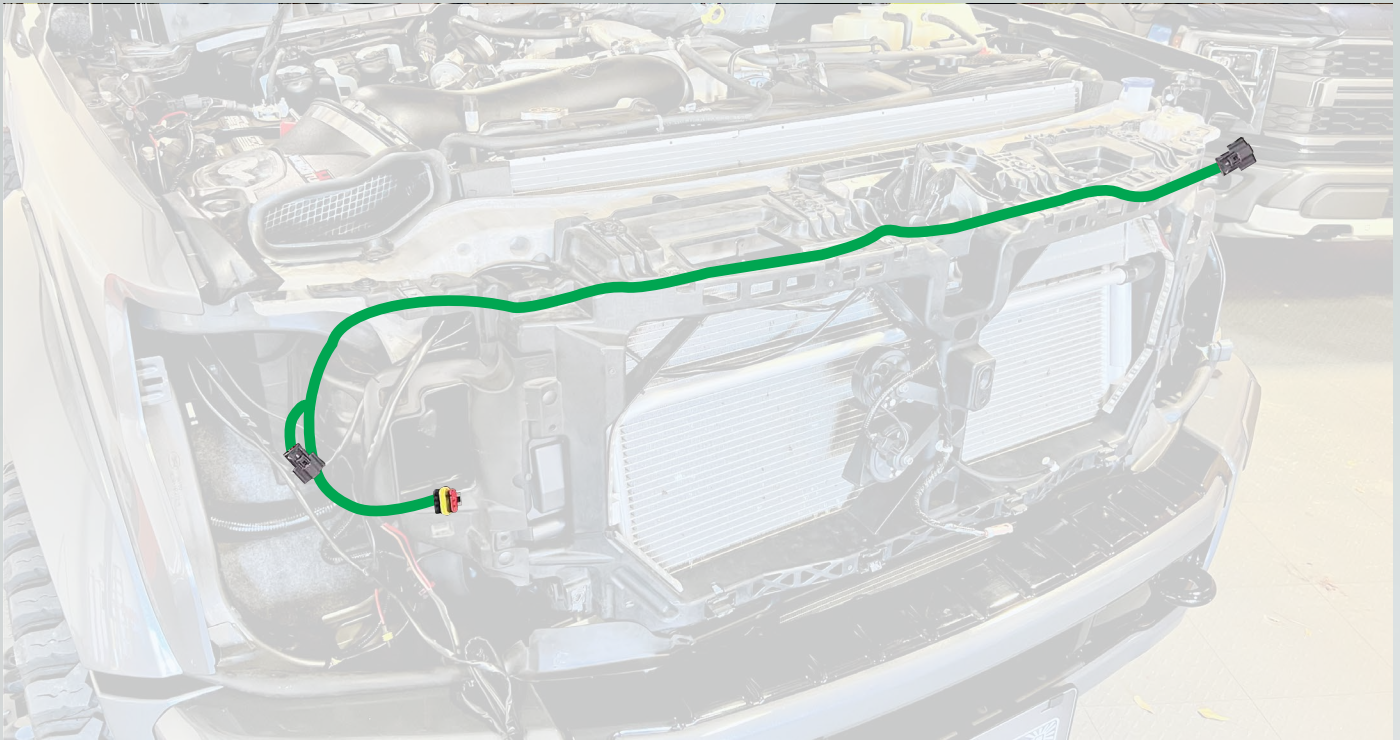

31. Locate the LED Adaptor Harness that is included with the grille.
- On the passenger side of the truck, plug in the adaptor into your truck wiring and the DRL harness.
  - Route the grille wiring toward the center of the grille.

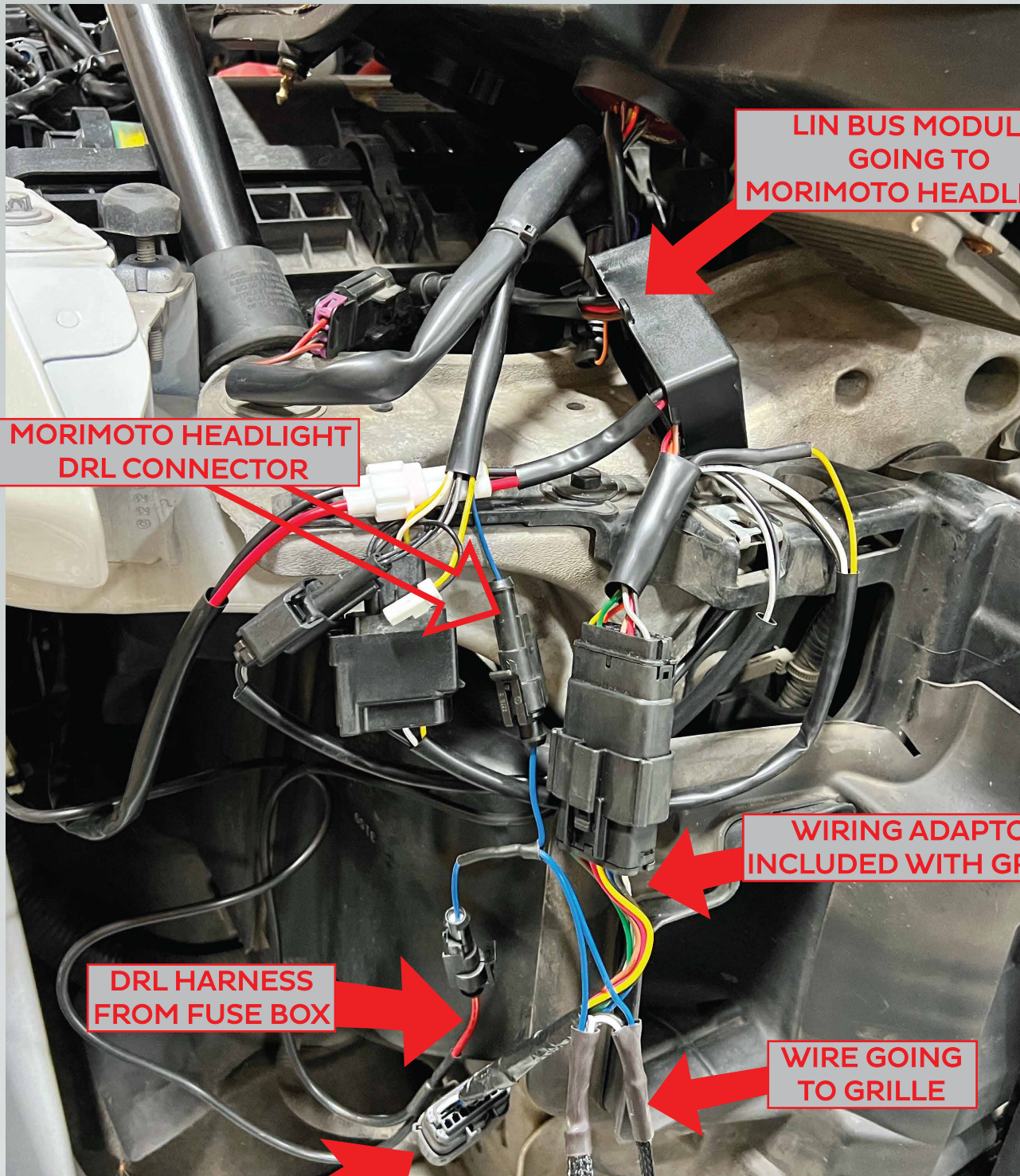

**LIN BUS MODULE  
GOING TO  
MORIMOTO HEADLIGHT**

**MORIMOTO HEADLIGHT  
DRL CONNECTOR**

**WIRING ADAPTOR  
INCLUDED WITH GRILLE**

**DRL HARNESS  
FROM FUSE BOX**

**WIRE GOING  
TO GRILLE**

**OEM HARNESS FROM TRUCK**

**OEM LED TRUCK USING  
MORIMOTO XB HEADLIGHTS**

32. Get the passenger side included Lin Bus module. Start by plugging in these two (2) connectors (IMAGE 3). Plug in the Crossover Harness into the Lin Bus module (IMAGE 4).

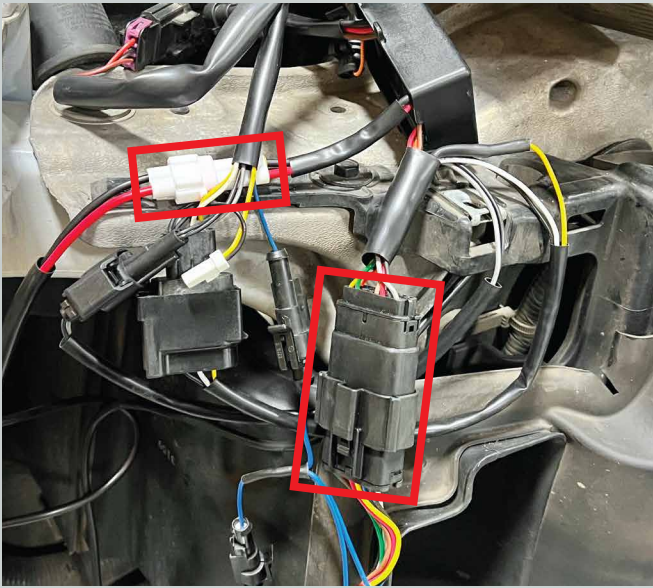

IMAGE 3

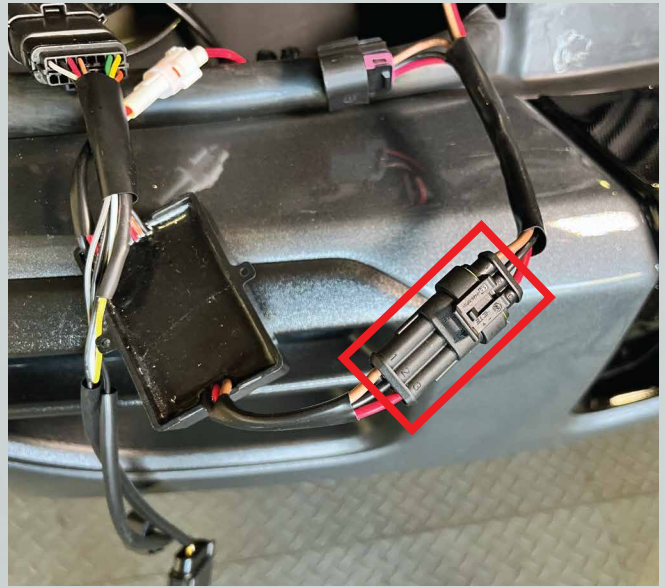

IMAGE 4

33. Grab your passenger side Morimoto headlight, bring it to the truck and plug in these two (2) connectors (IMAGE 5). Next plug in the DRL harness and the Crossover harness to the headlight (IMAGE 6).

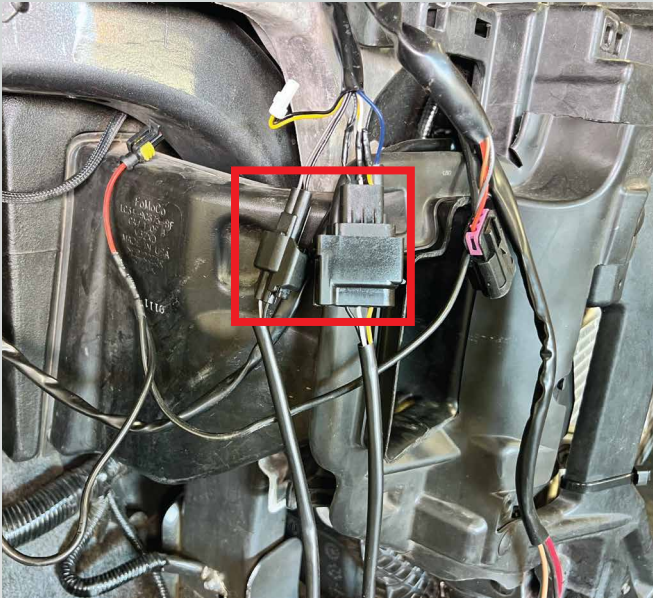

IMAGE 5

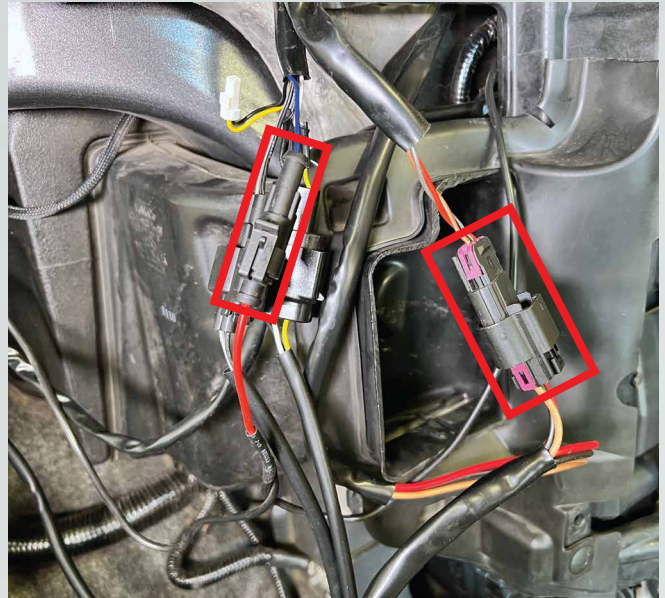
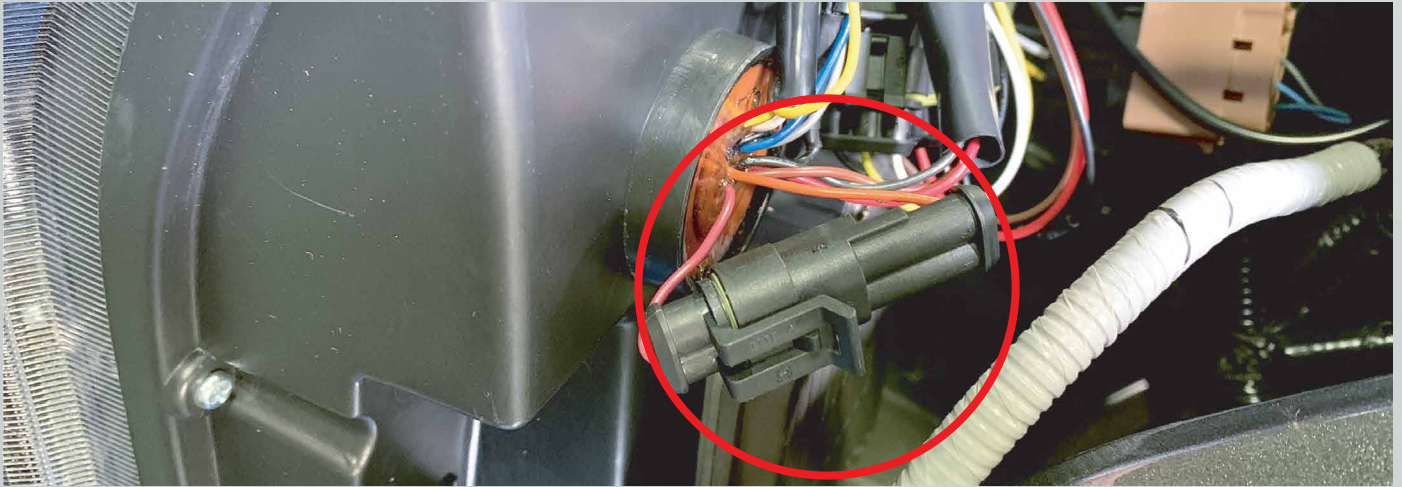

IMAGE 6

34. Slide the headlight into its mounting location making sure none of the wiring in the rear is getting pinched. Thread in the top bolts by hand.

35. Toggle between standard and sequential turn signal with this connector. Leave the connectors plugged in for a sequential turn signal. Leave the connectors unplugged for a standard turn signal.



36. Get the driver side included Lin Bus module and take it to the truck. Start by plugging in the multi pin connector (IMAGE 7). Get your driver side Morimoto headlight and plug in these two (2) connectors (IMAGE 8). Plug in the Crossover Harness and DRL harness into the Lin Bus module (IMAGE 9).



IMAGE 7

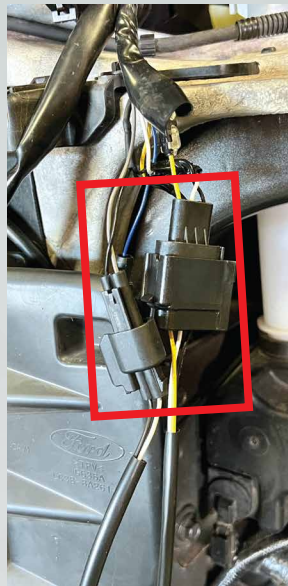

IMAGE 8



IMAGE 9

37. Slide the headlight into its mounting location making sure none of the wiring in the rear is getting pinched. Thread in the top bolts by hand.

**SKIP TO PAGE 26 TO CONTINUE THE INSTALL**

# INSTALL ON OEM LED TRUCK W/ OEM HEADLIGHTS



38. Complete steps #1-16. Slide the headlight forward. Unplug the multi pin connector, to do so press the release tab and pull the connector off.





39. Locate the fuse box under the hood on the passenger side, by the firewall and remove fuse #16. Find the included fuse tap harness and plug it in place of the fuse you just removed. Route the end of the harness to the passenger side headlight area.

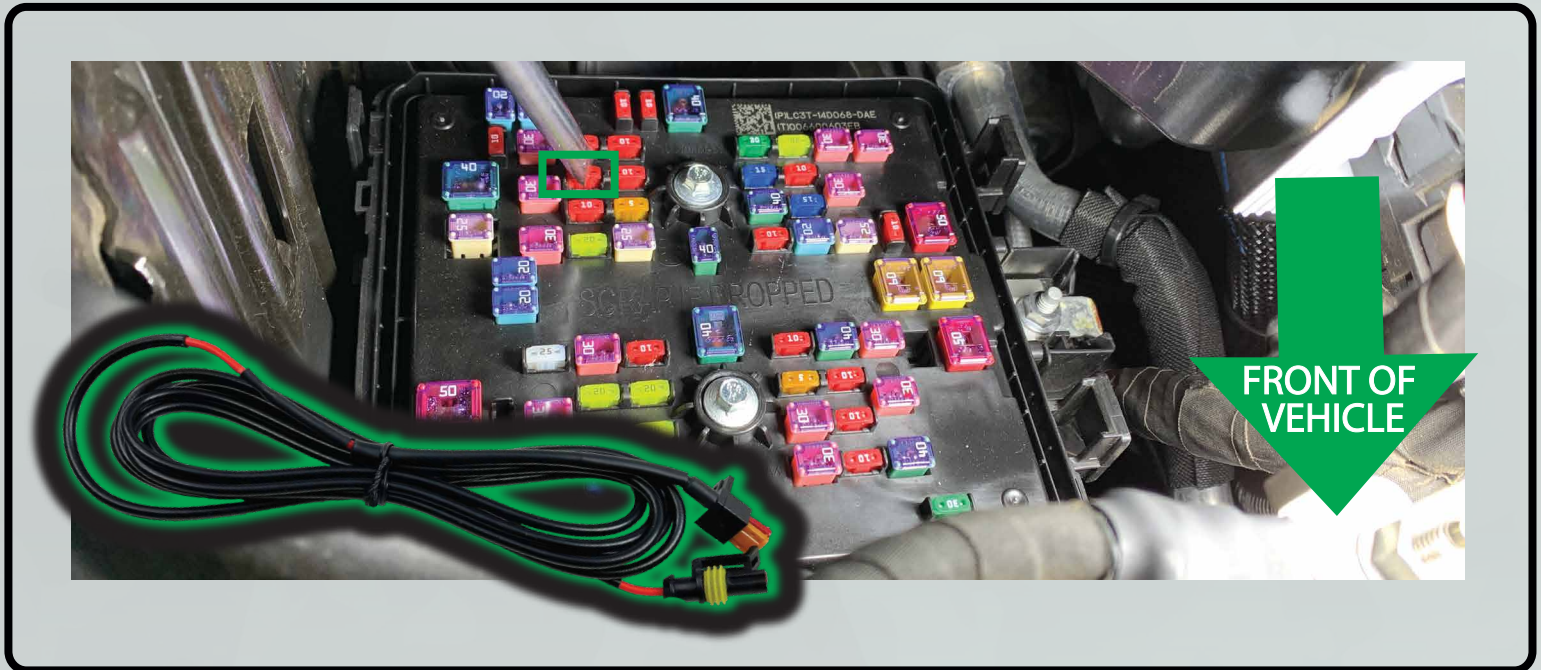

40. Locate the LED Adaptor Harness that is included with the grille.  
- On the passenger side of the truck, plug in the adaptor into your truck wiring and the DRL harness.  
- Route the grille wiring toward the center of the grille.

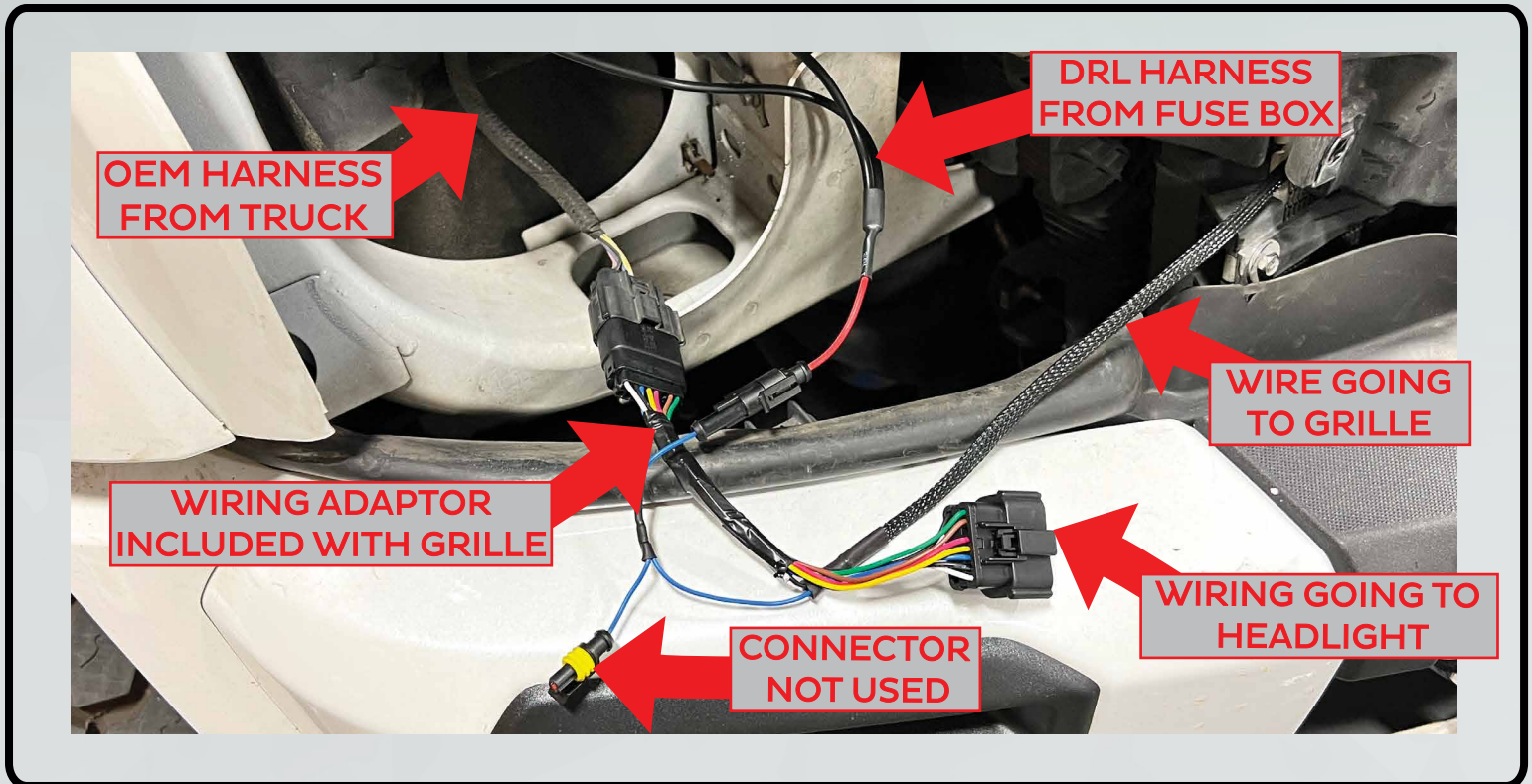

41. Get your oem headlight and plug the LED Adaptor harness into the headlight.  
42. Slide the headlight into its mounting location making sure none of the wiring in the rear is getting pinched. Thread in the top bolts by hand.

43. Get your oem grille and remove the three (3) 10mm holding the back of the emblem, slide the emblem away from the grille to remove it (IMAGE 10). Also remove the yellow plastic clip by sliding it down (image 10). Pry away and remove the four (4) metal clips on the bottom of the grille (IMAGE 11).

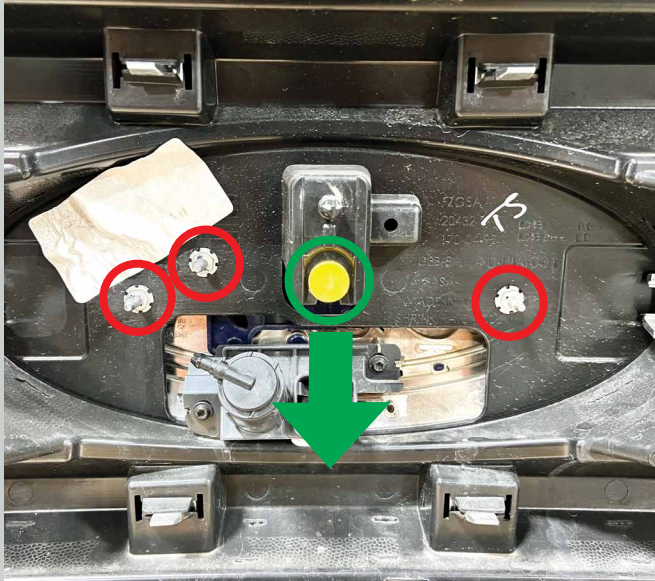

IMAGE 10



IMAGE 11

44. Locate the included Emblem Dampeners (IMAGE 12). (Note: thinner ones are to be used on OEM emblems, and the thicker ones are to be used on aftermarket emblems). Install the appropriate Emblem Dampeners on to the three (3) studs of your emblem (IMAGE 13).



IMAGE 12



IMAGE 13

45. Transfer the four (4) metal clips, one (1) plastic clip to your Morimoto grille (IMAGE 14). Also transfer the emblem and hand tighten the three (3) 10mm nuts. Next plug in the wires between the control box and the LED bars (IMAGE 15). When plugging in make sure to line up the arrows between the connectors, then thread on the locking nut.

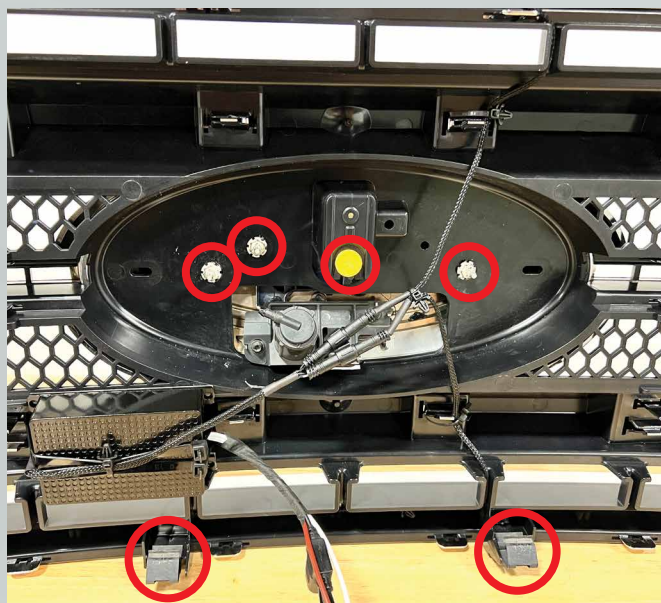

IMAGE 14

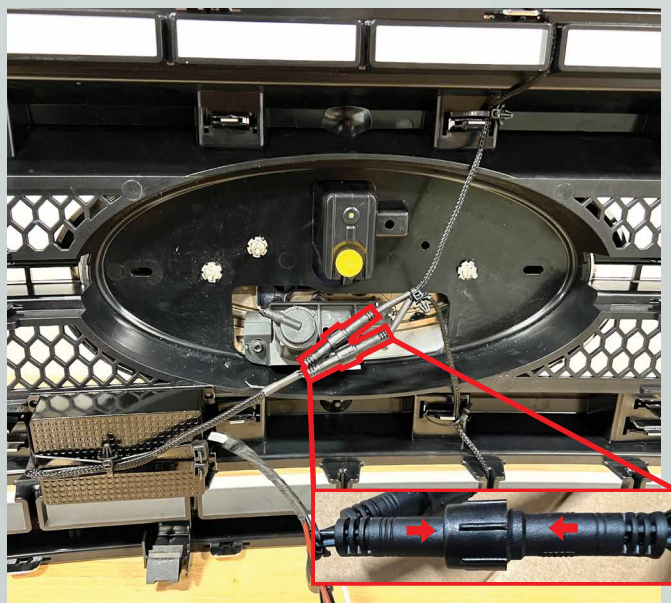
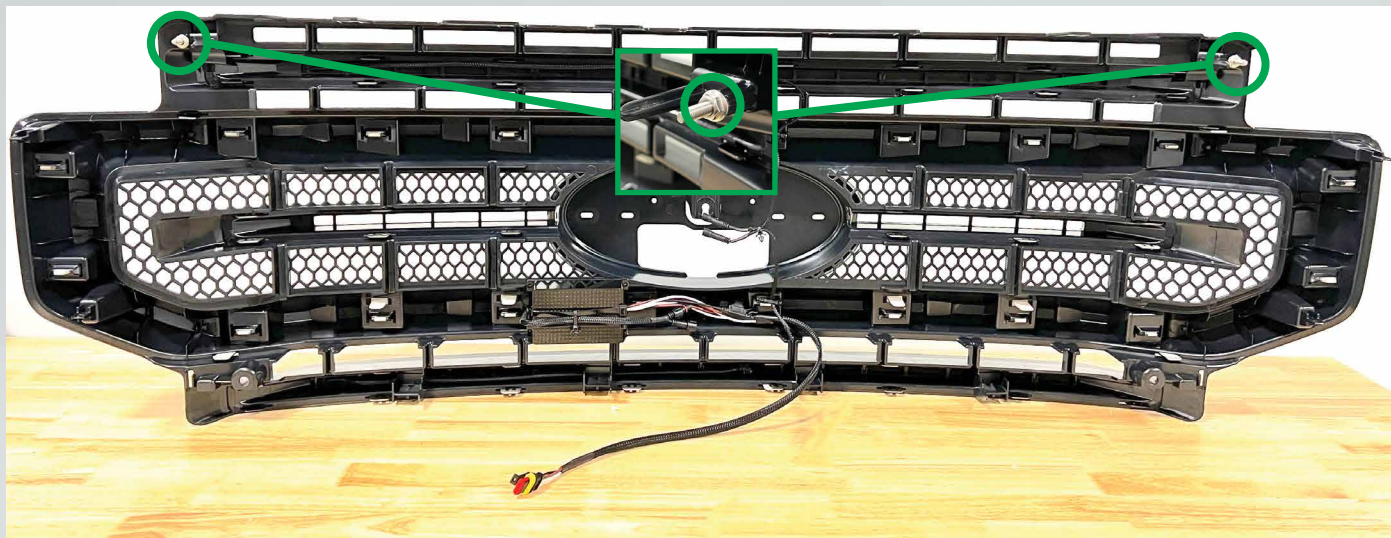
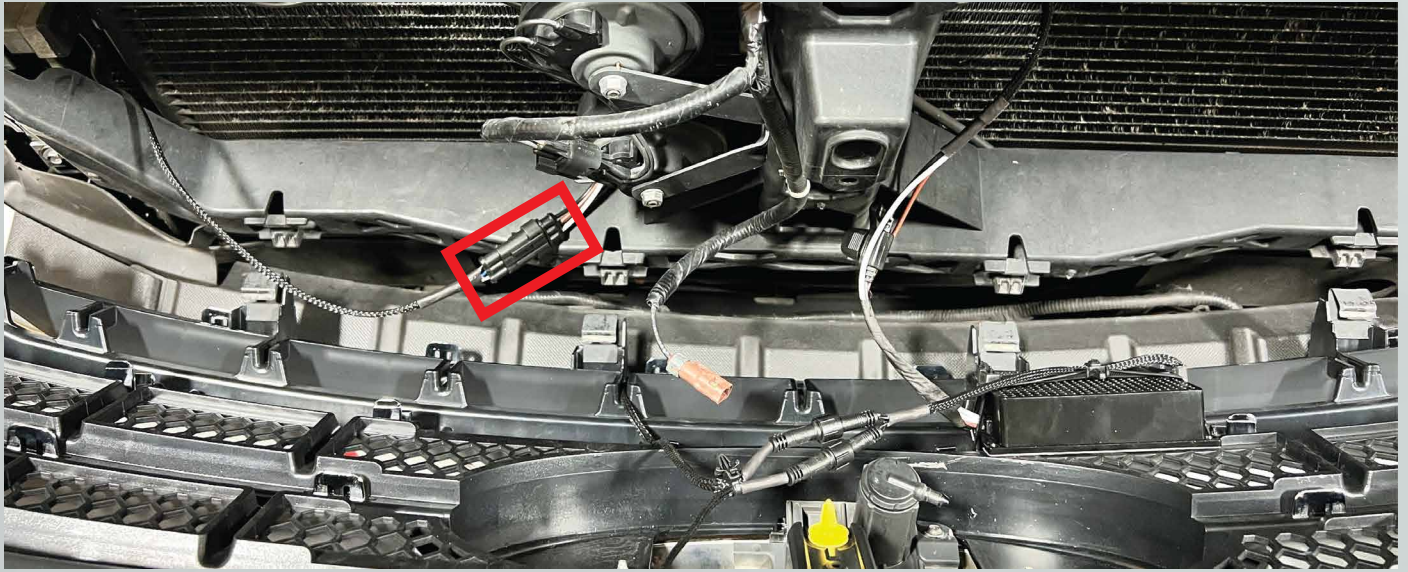

IMAGE 15

46. Remove the two (2) 10mm nuts at the top of your grille.



47. Take your Morimoto grille to the truck and plug in the grille wiring into the grille adaptor harness. Place the grille into its place and thread in two (2) top bolts to hold it in place.



48. Turn the truck on and test all of the functions to make sure everything works.

49. Reassemble the truck in the reverse order that you took it apart.

50. Install the included two (2) Plastic Flaps over the bottom grille bolts.



**PROCEED TO PAGE 3 FOR HEADLIGHT AIMING  
INSTRUCTIONS**