



# FORD 2021 Bronco 5" Lift Kit

**Thank you for choosing Rough Country for all your vehicle needs.**

Rough Country recommends a certified technician install this system. In addition to these instructions, professional knowledge of disassemble/reassembly procedures as well as post installation checks must be known. Attempts to install this system without this knowledge and expertise may jeopardize the integrity and/or operating safety of the vehicle.

Please read instructions before beginning installation. Check the kit hardware against the parts list. Be sure you have all needed parts and know where they go. Also please review tools needed list and make sure you have needed tools. If question exist, please call us @1-800-222-7023. We will be happy to answer any questions concerning this product. Check all fasteners for proper torque. Check to ensure for adequate clearance between all components. Periodically check all hardware for tightness.

### PRODUCT USE INFORMATION

**▲WARNING** The taller a vehicle is, the easier it will roll. We strongly recommend, because of rollover possibility that seat belts and shoulder harnesses should be worn at all times. Avoid situations where a side rollover may occur.

**▲WARNING** Generally, braking performance and capability are decreased when larger/heavier tires and wheels are used. Take this into consideration while driving. Do not add, alter, or fabricate any factory or after-market parts to increase vehicle height over the intended height of the Rough Country product purchased. Mixing component brands is not recommended.

Rough Country makes no claims regarding lifting devices and excludes any and all implied claims. We will not be responsible for any product that is altered. If questions exist we will be happy to answer them concerning the design, function, and correct use of our products.

The suspension system was developed using a 37 x 12.5 tires with 17 x 8.5 wheel with +34mm offset and 37 x 12.5 tires with 17 x 9 wheel with +27mm offset. The lifts were designed to lift the front to level the vehicle. Due to manufacturing, dimension variances, and inflation all tire and wheel combinations should be tested prior to installation on all oversized / wider then stock tires.

### ▲NOTICE DEALER AND VEHICLE OWNER

Any vehicle equipped with any Rough Country product should have a "Warning to Driver" decal installed on the inside of the windshield or on the vehicle's dash. The decal should act as a constant reminder for whoever is operating the vehi-

#### Torque Specs:

Size	Grade 5	Grade 8	Size	Class 8.8	Class 10.9
5/16"	15 ft/lbs	20ft/lbs	6MM	5ft/lbs	9ft/lbs
3/8"	30 ft/lbs	35ft/lbs	8MM	18ft/lbs	23ft/lbs
7/16"	45 ft/lbs	60ft/lbs	10MM	32ft/lbs	45ft/lbs
1/2"	65 ft/lbs	90ft/lbs	12MM	55ft/lbs	75ft/lbs
9/16"	95 ft/lbs	130ft/lbs	14MM	85ft/lbs	120ft/lbs
5/8"	135ft/lbs	175ft/lbs	16MM	130ft/lbs	165ft/lbs
3/4"	185ft/lbs	280ft/lbs	18MM	170ft/lbs	240ft/lbs

#### Alignment Specs

Front	
Caster	3.18° ± 0.60°
Camber	0.12° ± 0.50°
Toe	0.1°0 ± 0.15°



## Kit Contents

### 41100BOX1

- 1 - Pass Knuckle
- 1 - Dr Knuckle

### 41100BOX2

- 1 - Fr Crossmember
- 1 - Rr Crossmember

### 41100BOX4

- 1 - Fr Dr Strut Spacer
- 1 - Fr Pass Strut Spacer
- 2 - Rear Strut Spacers
- 4 - Fr Lower Strut Spacers
- 2 - 10MMSTUDBAG-2
- 6 - 10mm Stud
- 6 - 10mm Flange Nuts
- 1 - 10mm Nut
- 1 - 1/2" Jam Nut

### Tools Needed:

- |                    |                       |
|--------------------|-----------------------|
| 8mm Socket/Wrench  | 1/2" Socket/Wrench    |
| 10mm Socket/Wrench | 9/16" Socket/Wrench   |
| 13mm Socket/Wrench | 15/16" Socket/Wrench  |
| 15mm Socket/Wrench | 1-1/16" Socket/Wrench |
| 16mm Socket/Wrench | Screw Driver          |
| 17mm Socket/Wrench | Drill                 |
| 18mm Socket/Wrench | 13/32" Drill Bit      |
| 21mm Socket/Wrench | Coil Compressor       |
| 24mm Socket/Wrench | T45 Torx Bit          |
| 36mm Socket/Wrench | Sawzall               |

### 41100BOX3

- 1 - 41100BAG1 Front Kit Bag
- 5 - 10mm Lock Nuts
- 12 - 10mm Flat Washers
- 4 - 10mm x 25mm Bolts
- 4 - 12mm x 80mm Bolts
- 8 - 12mm Flat Washers
- 4 - 12mm Lock Nuts
- 4 - 16mm x 120mm Bolts
- 10 - 16mm Flat Washers
- 6 - 16mm Lock Nuts
- 7 - 3/8" x 1-1/4" Bolts
- 6 - 3/8" Flat Washers
- 1 - 3/8" Lock Nut
- 6 - 3/8" Lock Washers
- 2 - 9/16" x 2" Bolts
- 2 - 9/16" Flat Washers
- 2 - 9/16" Lock Nuts
- 1 - Dr Rr Diff Bracket
- 1 - Rr Brake Line Bracket
- 1 - Rr Axle Brake Line Bracket

### 1 - 41100BAG2 Rear Kit Bag

- 1 - 5/16" x 3/4" Bolt
- 2 - 5/16" Flat Washers
- 1 - 5/16" Flange Lock Nut
- 1 - 3/8" x 1.25"
- 2 - 3/8" Flat Washers
- 1 - 3/8" Lock Nut
- 1 - 5/8" x 4" Bolt
- 2 - 5/8" Flat Washers
- 1 - 5/8" Lock Nut
- 1 - 505BAG3 Cam Bolt Bag
- 4 - 16mm Cam Bolts
- 8 - 16mm Cam Washers
- 4 - 16mm Lock Nuts
- 6 - Cam Block Off Plates
- 1 - Dr Sway Bar Drop Bracket
- 1 - Pass Sway Bar Drop Bracket
- 1 - Rr Track Bar Bracket
- 1 - QR Code for Instructions
- 1 - Skid Plate
- 1 - Dr Diff Bracket
- 1 - Dr Diff Brace



## FRONT INSTALLATION INSTRUCTIONS

1. Jack up the front of the vehicle and place on jack stands. Remove the front wheels.
2. Remove the skid plates using a 15mm socket/wrench. **See Photo 1 and Photo 2.**

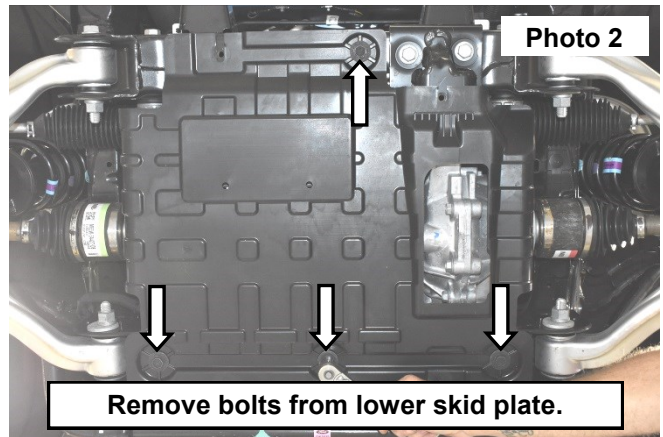
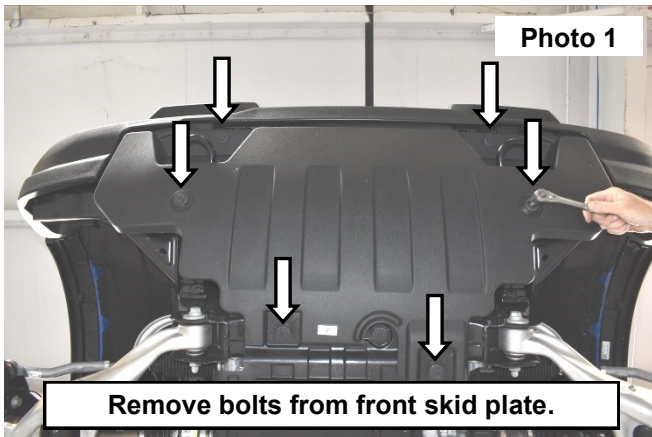

3. Unplug the rack and pinion. **See Photo 3.**
4. Remove the tie rod end using a 21mm socket/wrench. Strike the knuckle with a hammer if needed to remove the tie rod end. **NOTE: Strike from the outside in to prevent over stretching components. See Photo 4 and Photo 5.**

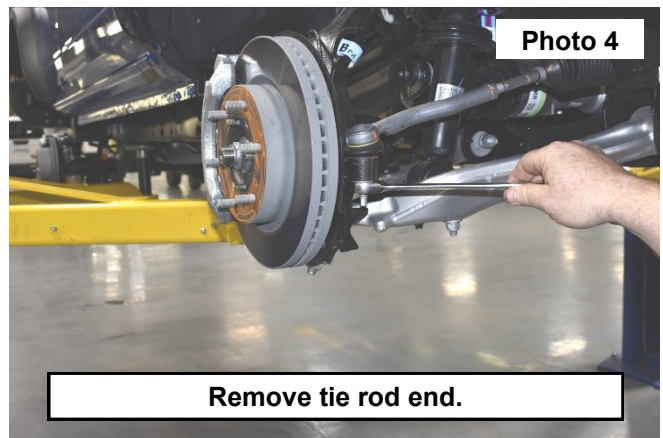
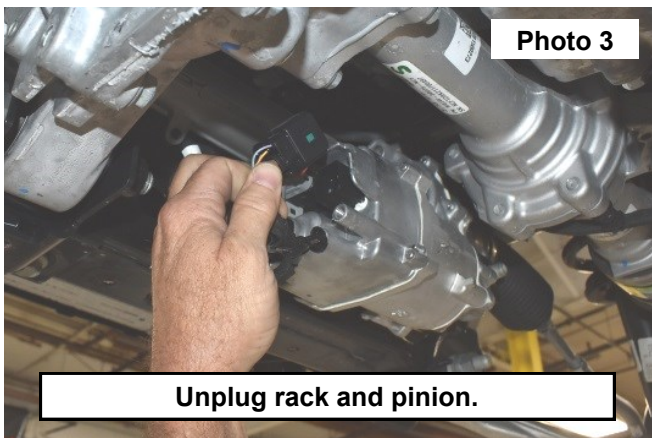

5. Remove the ABS wire and brake line from the knuckle using a 10mm socket/wrench. **See Photo 6.**

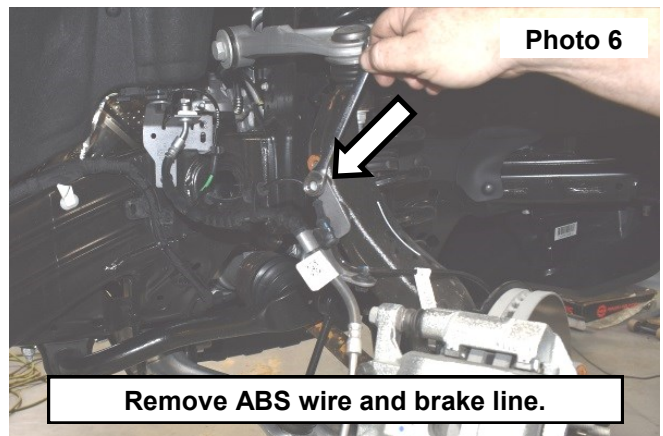
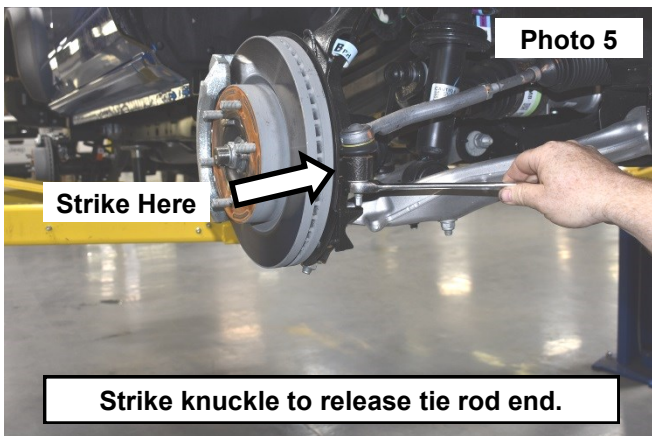



6. Remove upper ball joint just using an 18mm socket/wrench. Strike knuckle with a hammer if needed. **See Photo 7.**
7. Remove the lower sway bar nut using a 21mm socket/wrench. **See Photo 8.**

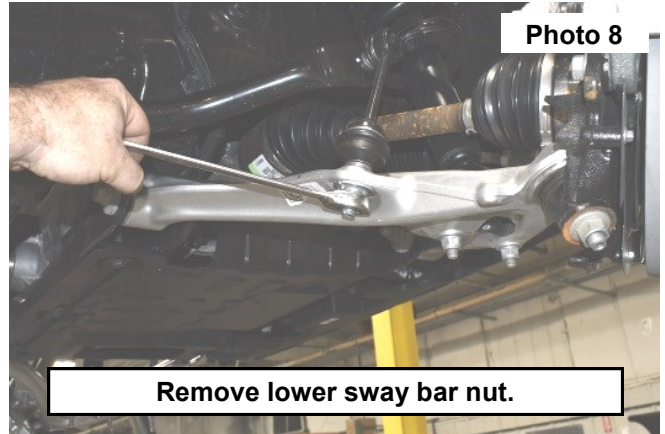
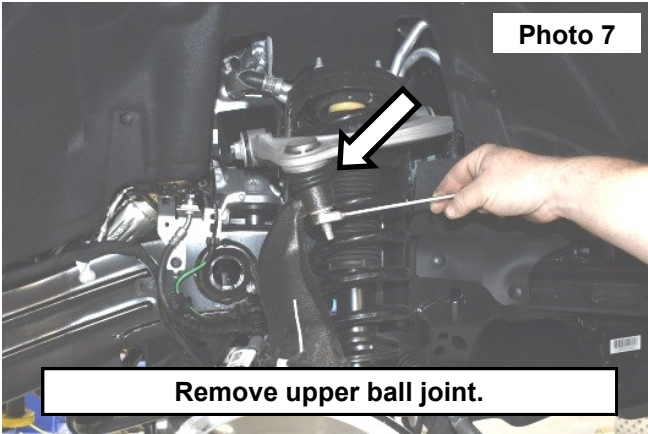

8. Remove the lower strut bolts using an 18mm socket/wrench. **See Photo 9.**
9. Remove the upper strut nuts using a 15mm socket/wrench. **See Photo 10.**

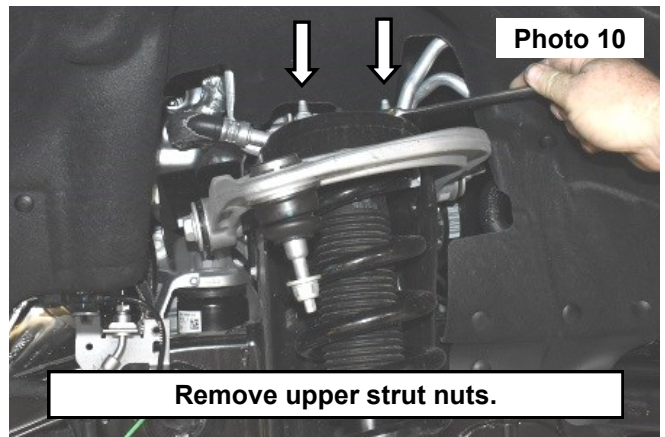
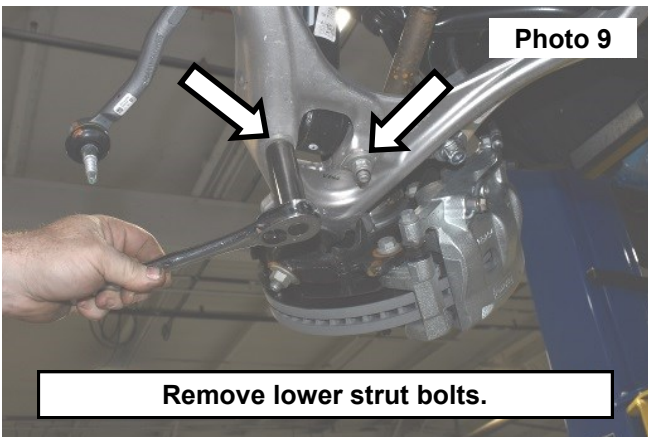

10. Remove the axle nut using a 36mm socket/wrench. Strike with hammer to loosen if needed. **NOTE: Take care not to damage the threads. See Photo 11.**
11. Remove the strut from the vehicle. **See Photo 12.**

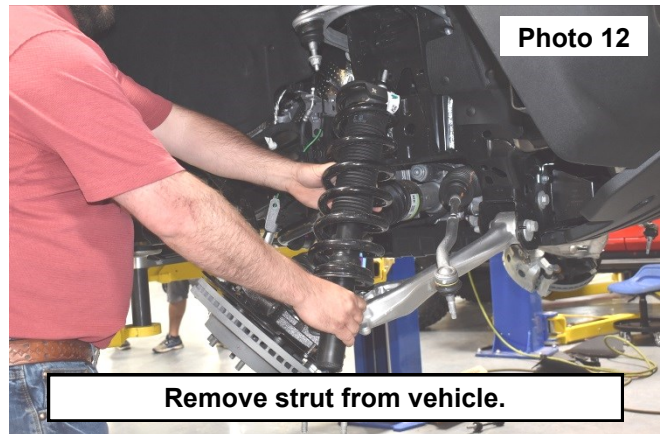
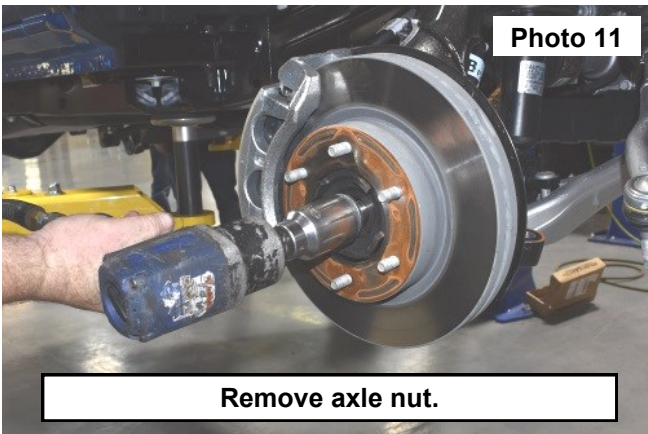



12. Using a paint pen, mark a straight line on the drive shaft and the yoke. **See Photo 13.**  
 13. Using a T45 Torx, remove the 6 bolts from the drive shaft. **See Photo 14.** Retain hardware for reuse.

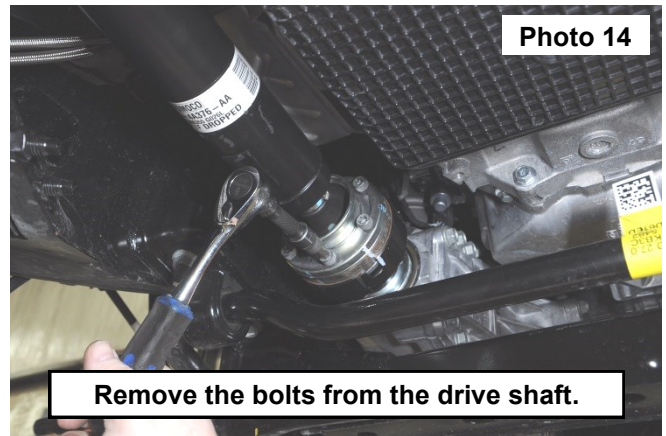
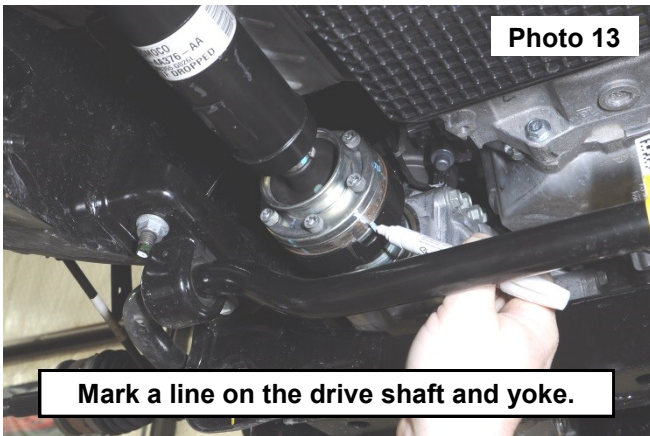

14. Remove the 2 bolts and 2 nuts on each side of the sway bar mount to the frame, using an 18mm socket. **See Photo 15.** Retain sway bar and hardware for reuse.  
 15. Support the diff. using a jack.  
 16. Remove the passenger side rear diff bolt, using a 13mm socket. Retain bolt for reuse. **See Photo 16.** Remove the flag nut as shown in **Photo 16A.**

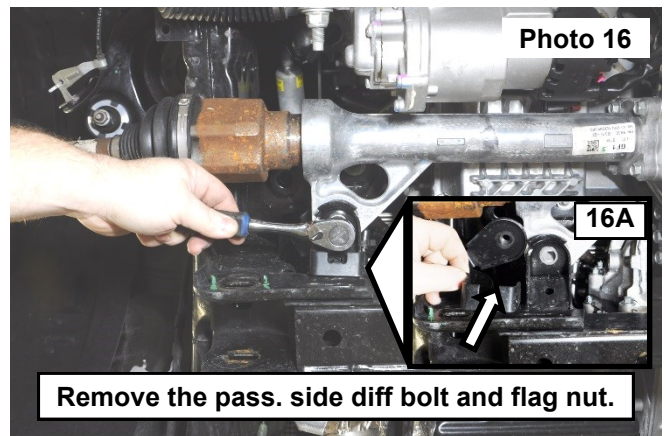
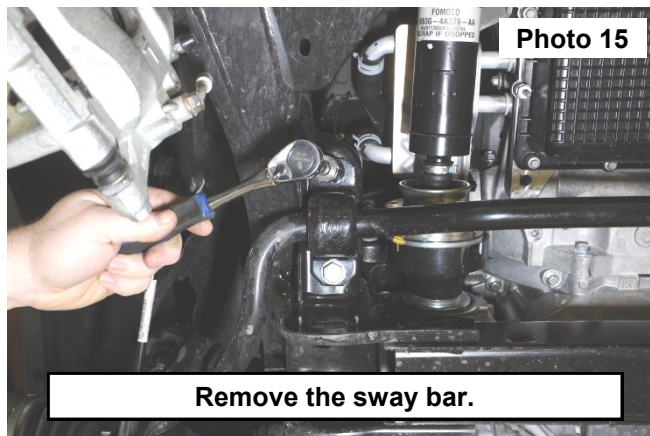

17. Remove the 2 rear driver side diff bolts, located above the yoke. Use a 18mm socket. Retain hardware. **See Photo 17.**  
 18. Remove the bolt in the front of the diff, using a 21mm socket. **See Photo 18.** Retain hardware for reuse.  
**NOTE: The nut is welded into the removeable diff mount plate.**

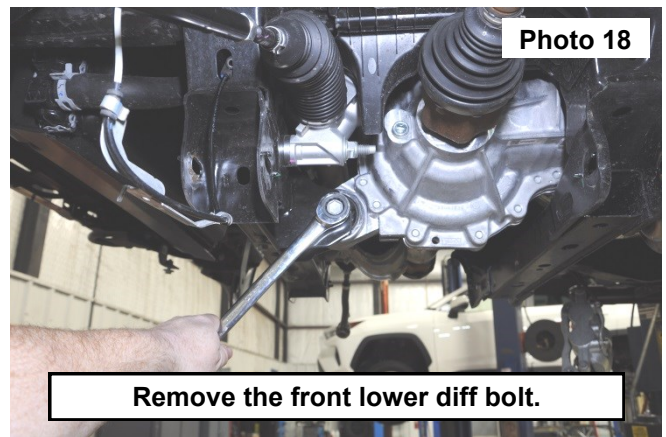
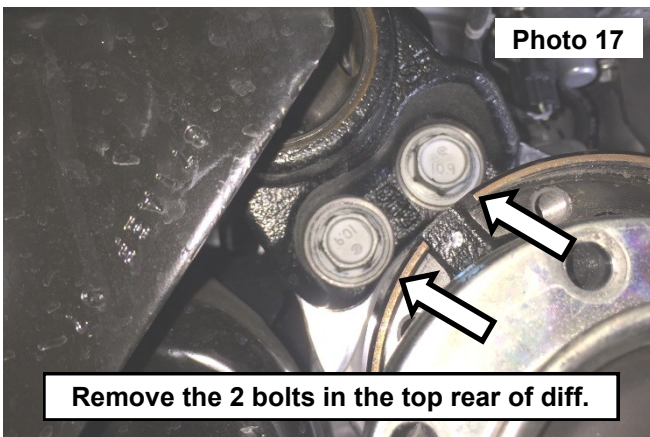



19. Remove the diff mounting plate, using an 18mm socket. **See Photo 19.** Retain hardware for reuse.
20. Remove diff by rotating the pinion up while lowering diff down.
21. Use the supplied template on the rear crossmember. Use a paint pen to mark the cut line on all 4 corners of the cross member. **See Photos 20 and 21.**

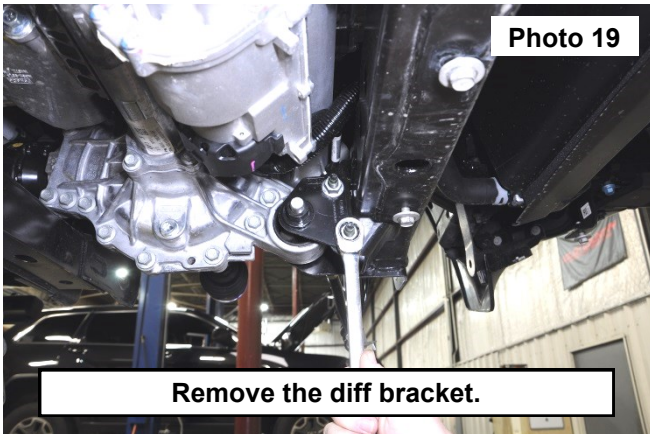

**Remove the diff bracket.**

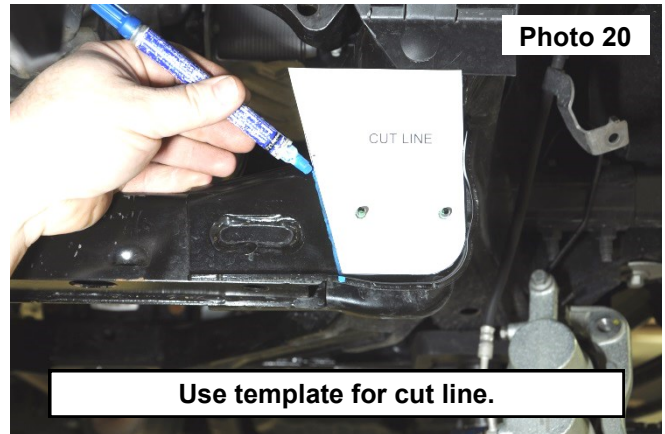

**Use template for cut line.**

22. Use a reciprocating saw to trim the lines made on the crossmember, remove the center of the rear crossmember. **See Photo 22.**

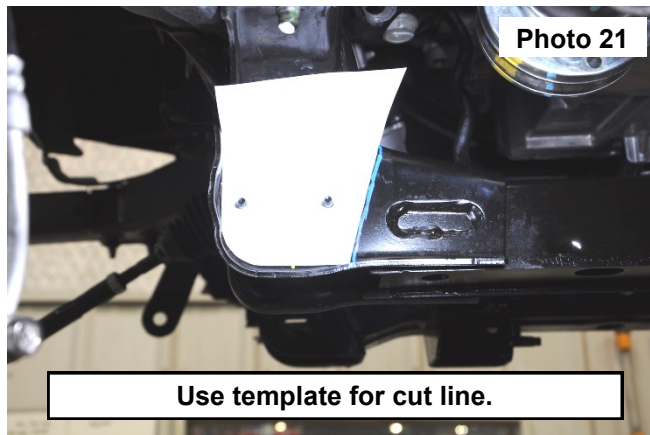

**Use template for cut line.**

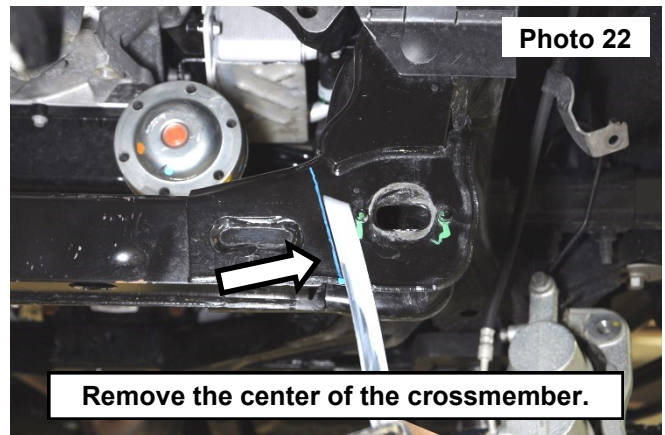

**Remove the center of the crossmember.**

23. Remove the center of the crossmember. **See Photo 23.**
24. Locate the supplied template, fold the dotted lines to fit onto the profile of the control arm mount and trim the holes to fit over the alignment tabs. **See Photo 24.**

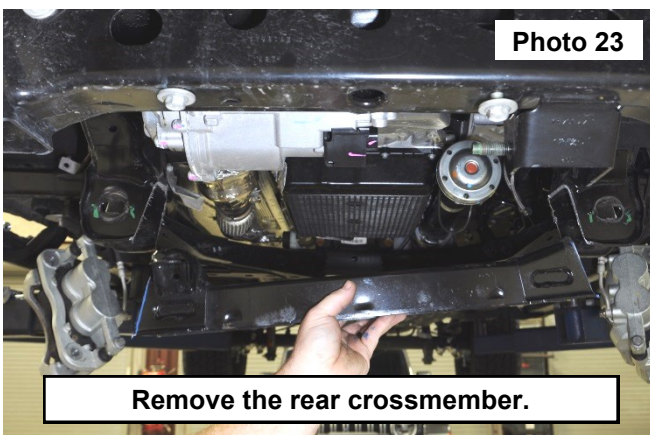

**Remove the rear crossmember.**

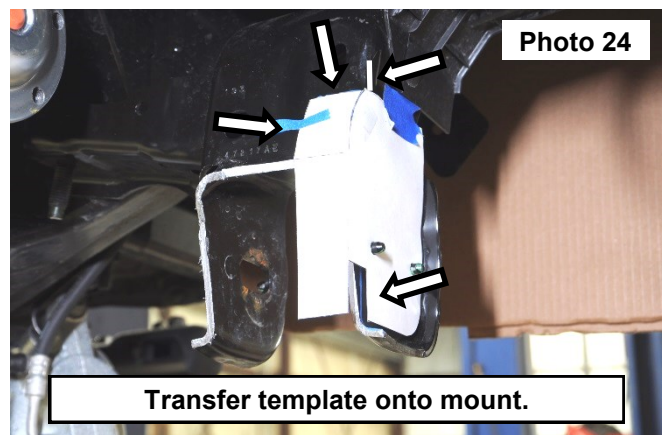

**Transfer template onto mount.**



25. Use a paint pen, transfer the out side of the template onto the control arm mount.
26. Remove the template and connect the front side of the marks using a straight edge. **See Photo 25.**
27. Use a reciprocating saw to trim the lines made on the mount. **See Photo 26.**

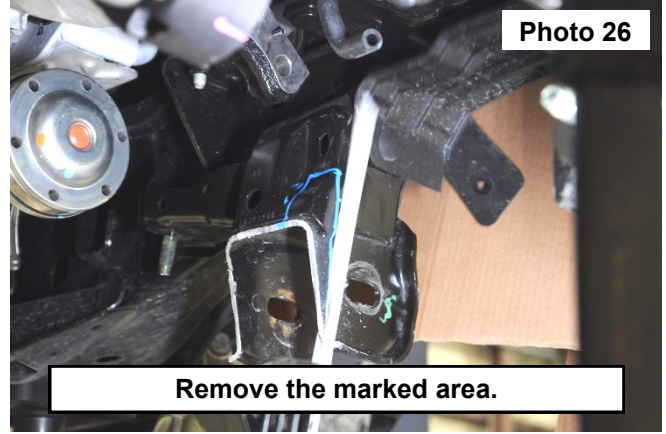
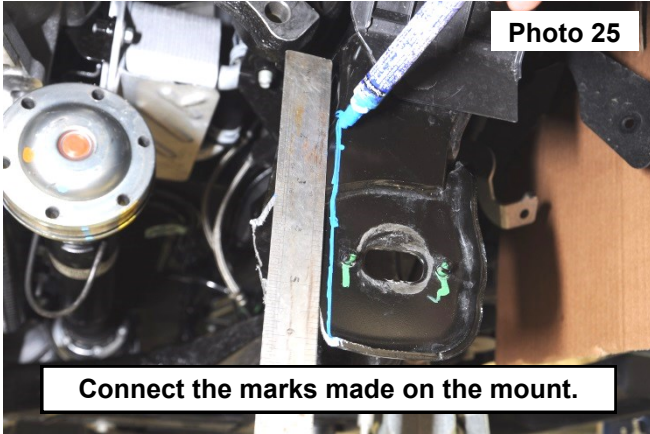

28. Sand and smooth all trimmed areas on both sides of the control arm mounts. Paint these areas to prevent rust. **See Photo 27.**
29. Install rear diff mount with the supplied 9/16"x 2" hardware using 13/16" socket/wrench. **See Photos 28 and Photo 29.**

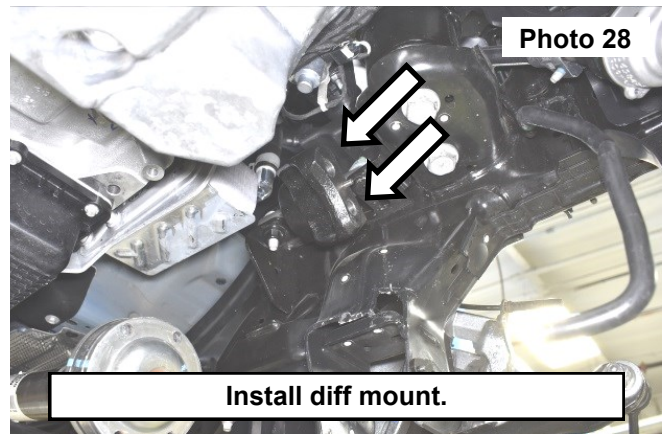
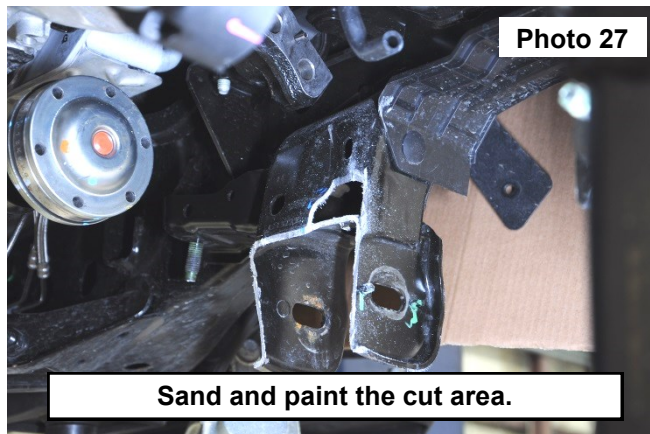

30. Install the new front diff bracket with the retained bolts and supplied 16mm nut and washer for the upper bolt. Tighten using an 18mm and 24mm wrenches. **See Photo 30.**

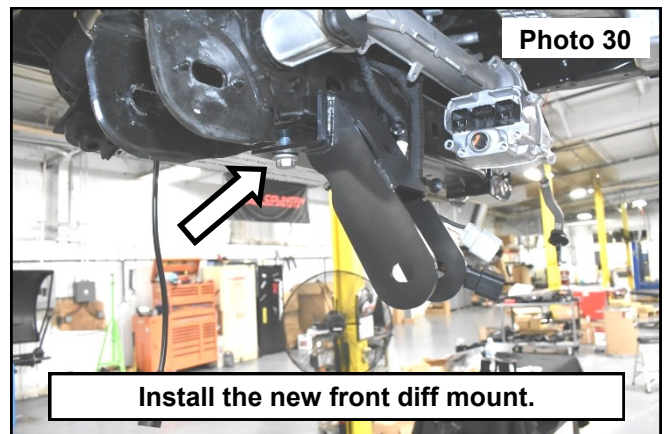
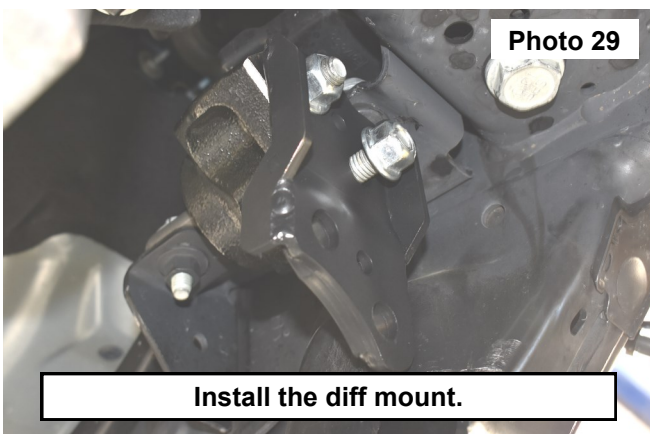



31. Install the front cross member using the 16mm hardware and cam block off plates. **See Photo 31 and Photo 32.**

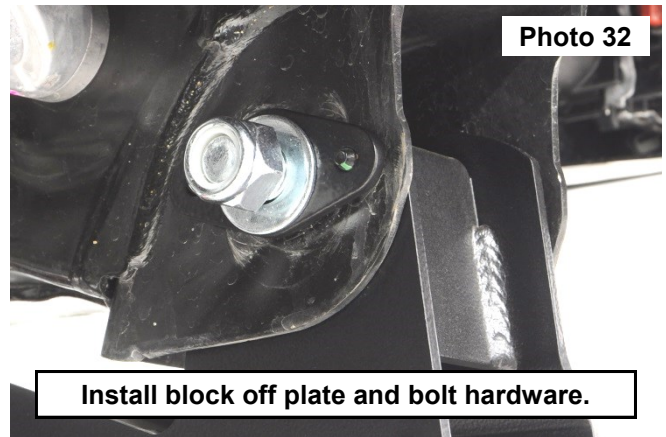
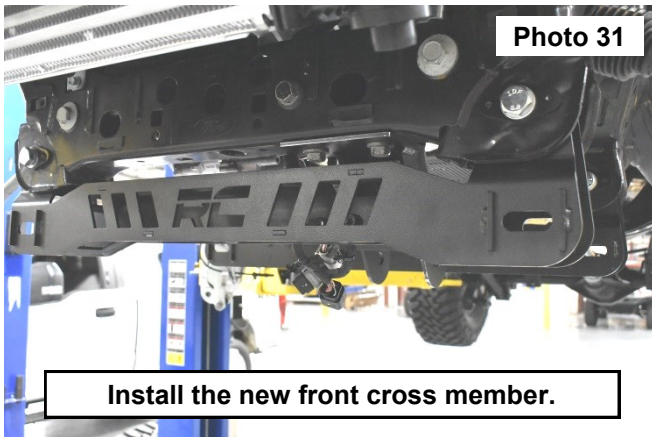

32. Install the front diff brace to the front diff bracket and crossmember with the supplied 3/8" hardware using 9/16" socket/wrench. **See Photo 33.** Do not tighten at this time.

33. Install the front differential in the front diff mount using the stock bolt and supplied 16mm nut and washer. **See Photo 34.**

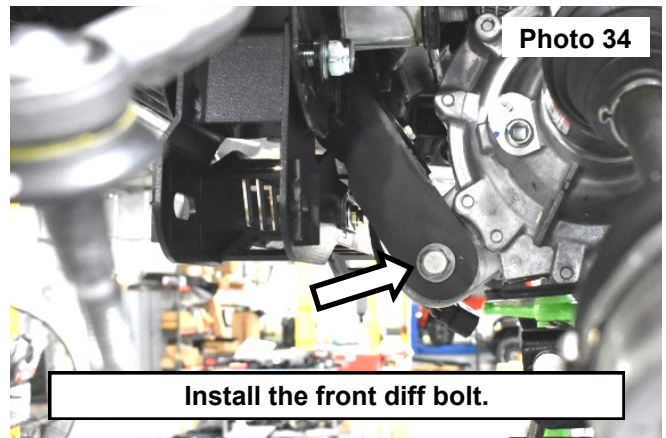
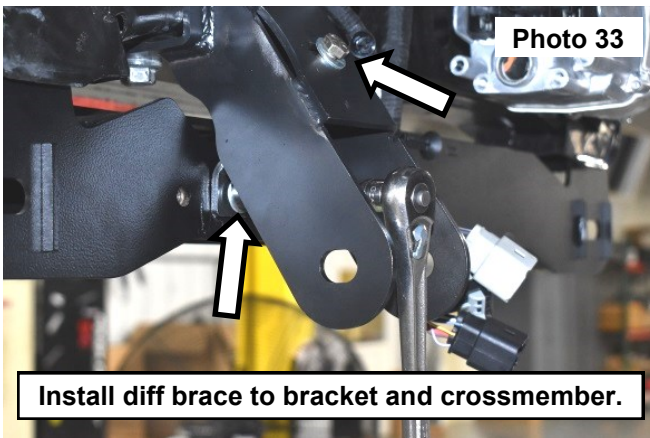

34. Install the rear cross member using the supplied cam block off plate on the alignment tabs on the front of the mount. Secure using the supplied 16mm bolts and washers (**do not install nuts at this point yet**). Attach the differential to the mount on the rear crossmember using the factory bolt and supplied 10mm washer and nut. **See Photo 35 and 36.**

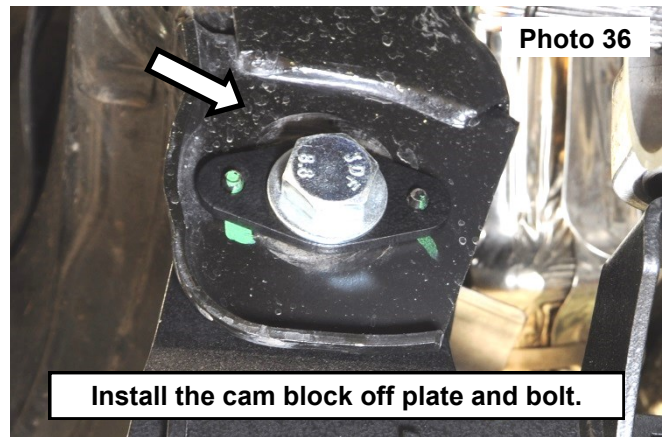
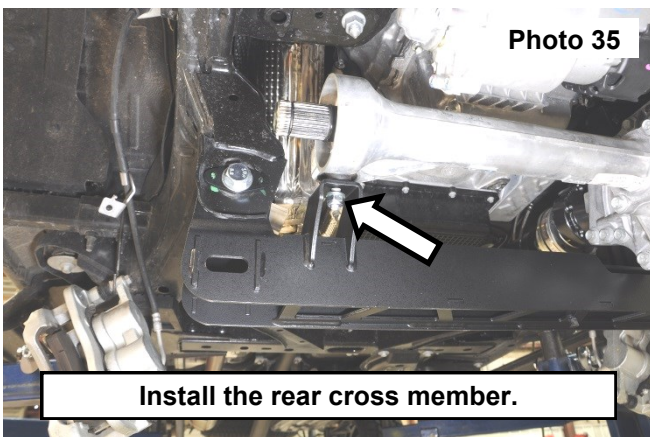



35. Install the retained OE bolt, 10mm washer, and 10-1.5mm nylock nut in the passengers side diff mount on the rear crossmember. **See Photo 37.** Do not tighten at this time.
36. Install the sway bar drops for each side of the vehicle onto the crossmember bolt using (1) of the supplied 16mm flat washer and (1) 16mm-2.0mm nylock nuts. Use the retained factory nut and bolt in the top of the sway bar drop mount. **See Photo 38.** Do not tighten at this time.

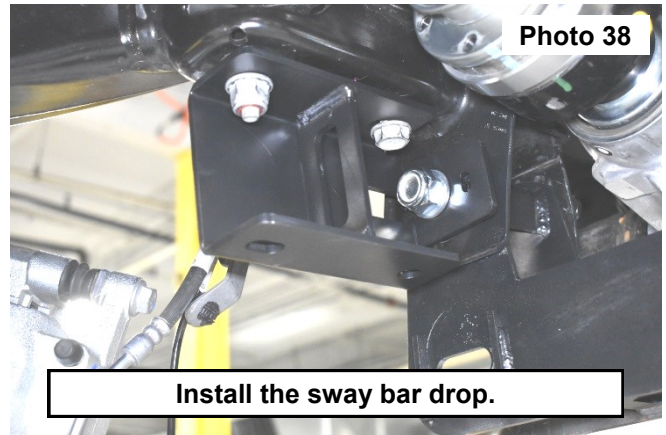
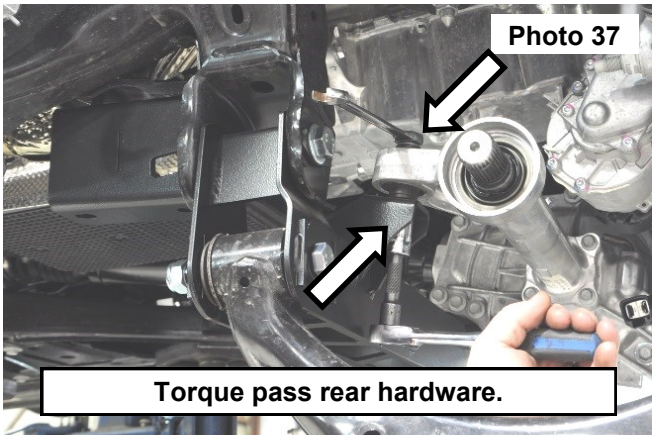

37. Install the lower control arms securing the supplied bolts and cam washers into the new crossmembers. Do not tighten and only snug the nuts and bolts using a 24mm wrench and socket. These will be tightened once the truck is on the ground. **See Photo 39.**
38. **Tighten the pass rear diff hardware, front diff hardware, front and rear upper crossmember bolts, and sway bar drop hardware.** See Photo 40.

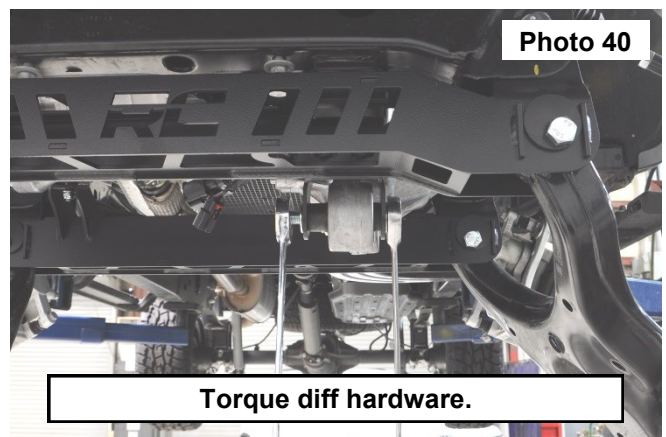
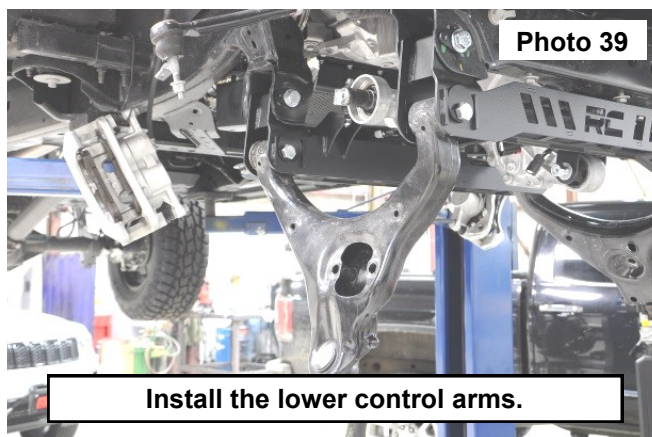

39. Install the drive shaft using the factory hardware. Torque to 18 ft-lbs. using a 6mm allen. **See Photo 41.**
40. Install the sway bar onto the sway bar drops using the supplied 10mm x 25mm bolts, washers and nuts. Torque to 45 ft-lbs. using 16mm wrench and socket. **See Photo 42.**

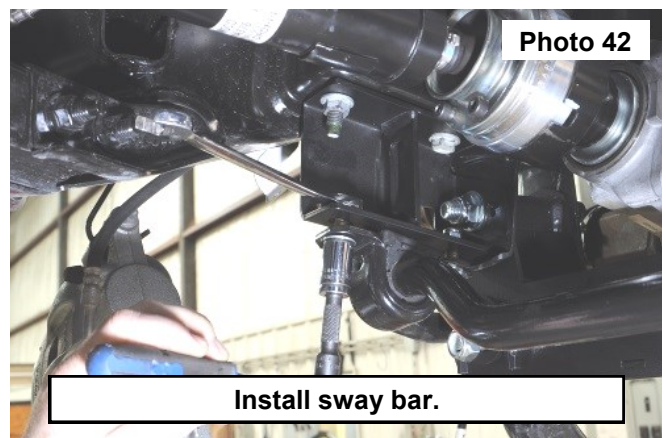
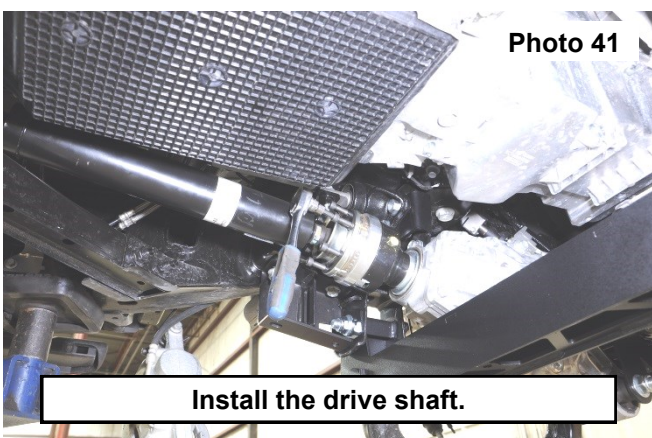



41. Install the skid plate onto the front and rear crossmembers using the (4) supplied 3/8-16 x 1 hex head bolts and (4) 3/8 flat washers. Torque to 30 ft-lbs. using a 9/16 socket. **See Photo 43 and 44.**

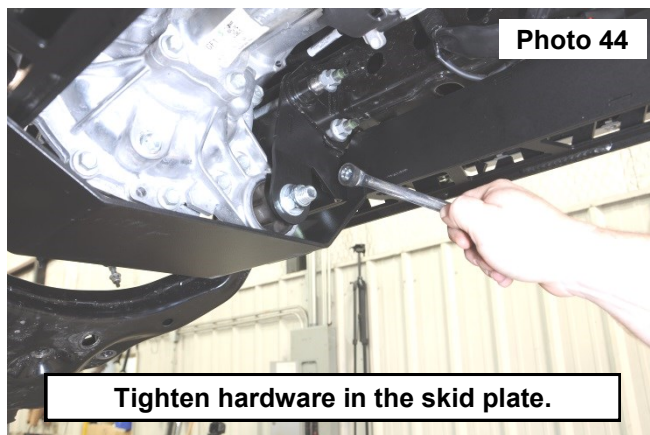
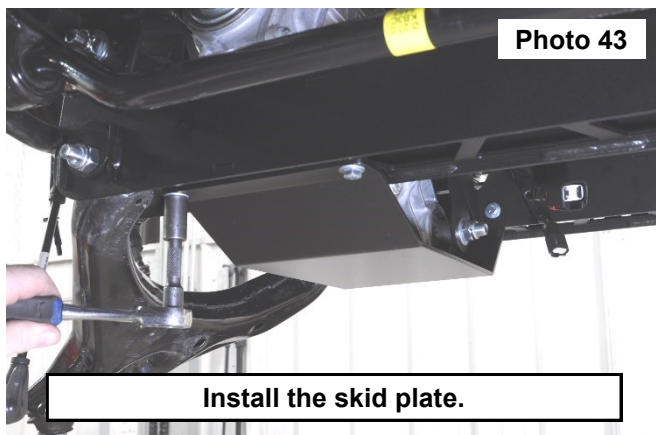

42. Identify the spacers cut into the top of each spacer is a D for the drivers side and a P for the passengers side. **See Photo 45.**
43. Install the (3) studs in the small holes in each spacer. use the supplied 1/2 inch jam nut for a spacer along with the 10mm nut using a 17mm socket to seat the stud in the top of the spacer. **See Photo 46.**

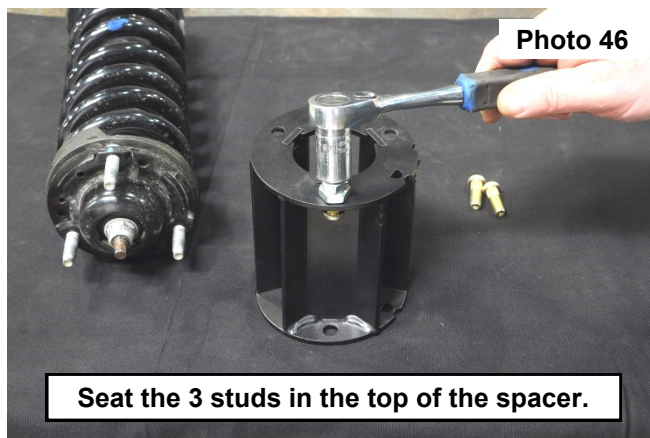
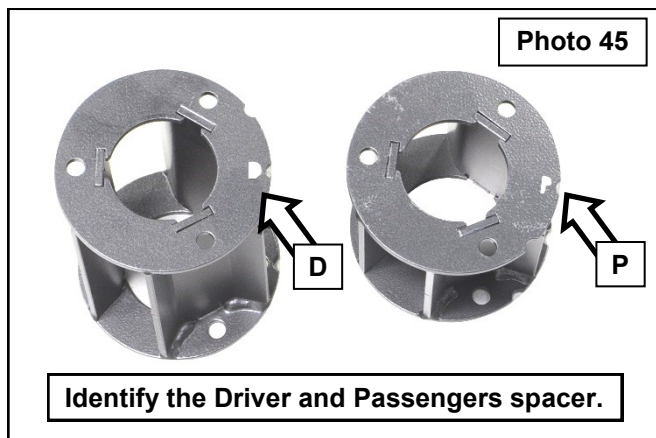

44. Remove the roll pin from front struts. **See Photo 47.**
45. **Driver Side Only:** Use a strut compressor or coil spring compressor to compress the coil. Then, rotate the strut body 180°. **Do not change top hat and coil orientation.** **See Photo 48.**

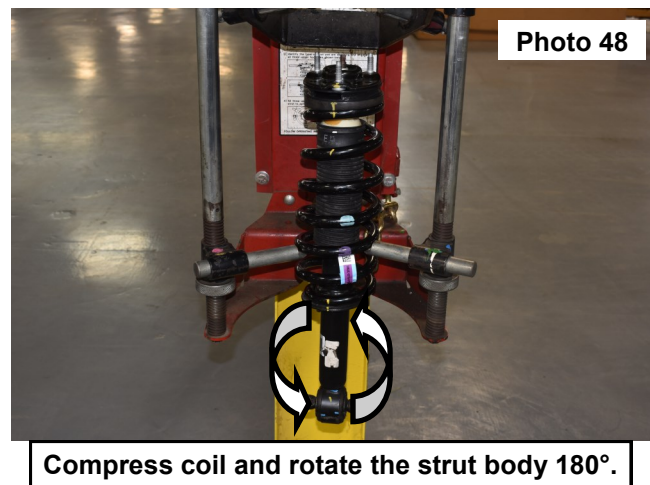
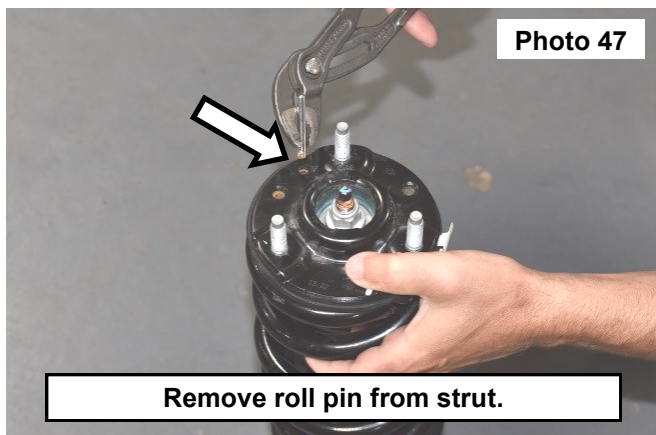



46. Install the spacer onto the top of the strut with the D or P oriented towards the outside of the vehicle closer to the wheels using the 3 OE nuts. Torque to 35 ft-lbs. use a 15mm socket. **See Photo 49.**
47. Install the strut, secure using the (3) supplied 10mm flange nuts on top of the strut mount. Do not tighten at this time. **See Photo 50.** **NOTE: The "D" and "P" on spacers must be oriented out towards the wheels.**

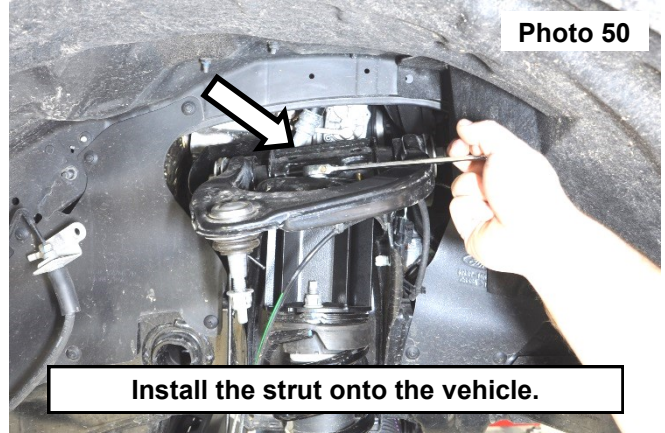
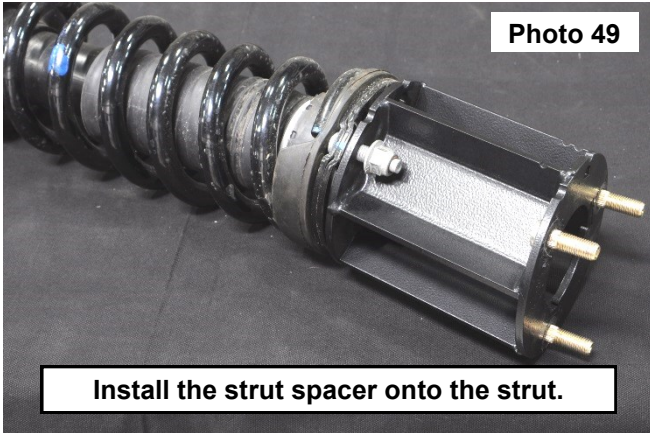

48. Raise the lower control arm up and install (2) of the horse shoe spacers on each side using the supplied 12mm x 80mm bolts, nuts, and washers. **See Photo 51.**
49. Remove the hub bolts in the back side of the OE knuckle using a 18mm socket. **See Photo 52.**

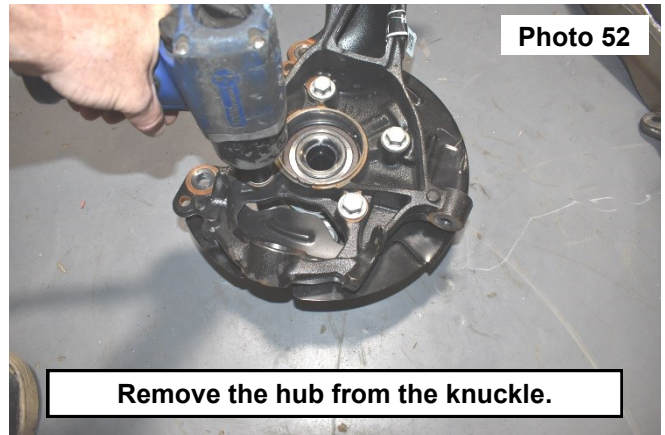
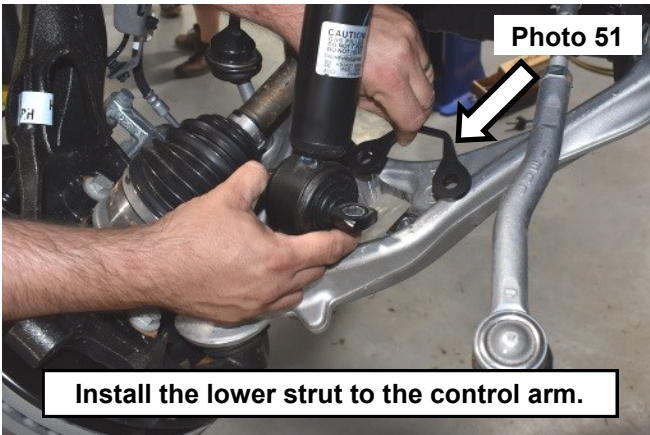

50. Remove the dust shield from the OE knuckle using a 8mm socket. **See Photo 53.**
51. Install the stock hub to the new knuckle using the stock hardware. **See Photo 54.**

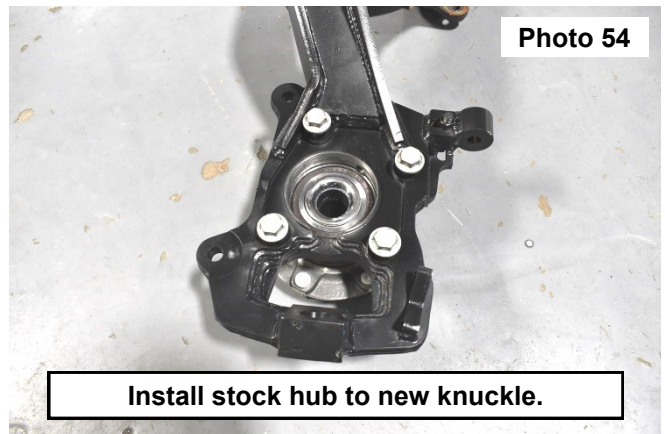
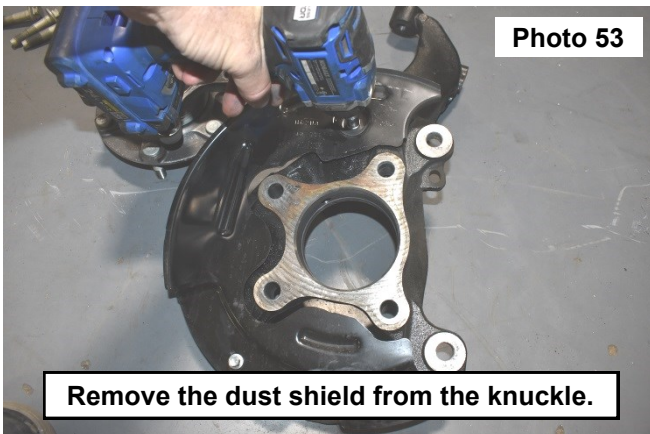



52. Install the stock dust shield to the new knuckle using the stock hardware. **See Photo 55.**

53. Install the knuckle to the axle and lower control arm using the stock hardware. **See Photo 56 and Photo 57.**

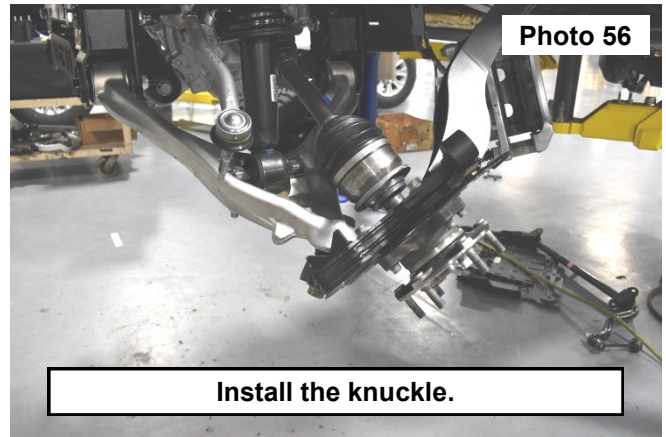

54. Install the knuckle to the upper ball joint using the stock hardware. **See Photo 58.**

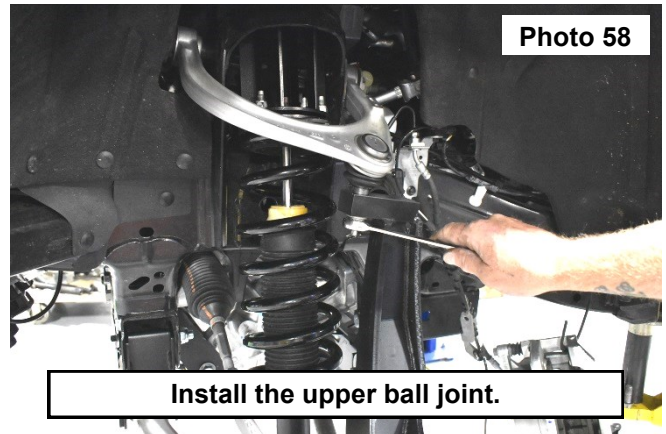
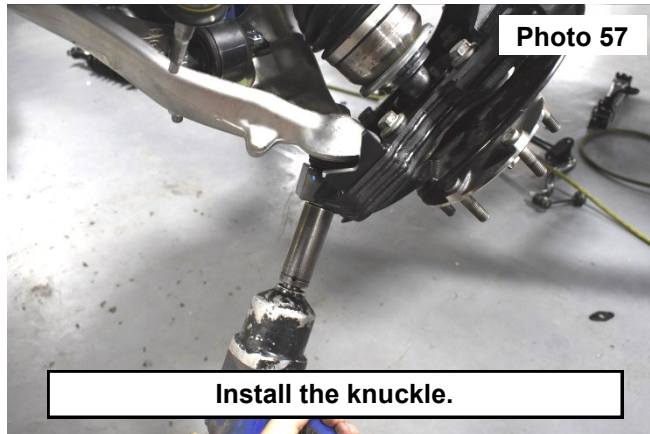

55. Install the axle nut using a 36mm socket. **See Photo 59.**

56. Install the rotor to the hub. **See Photo 60.**

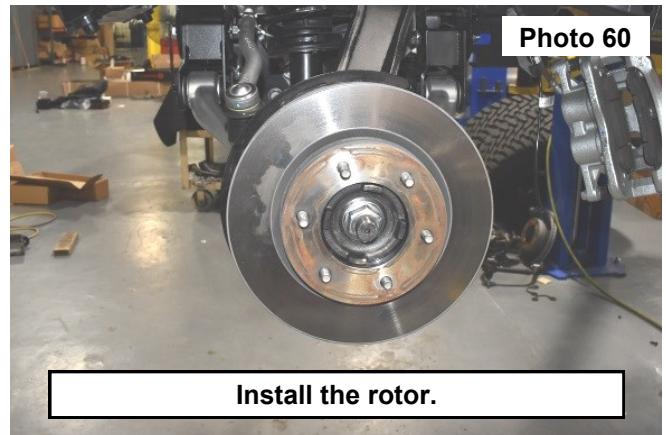
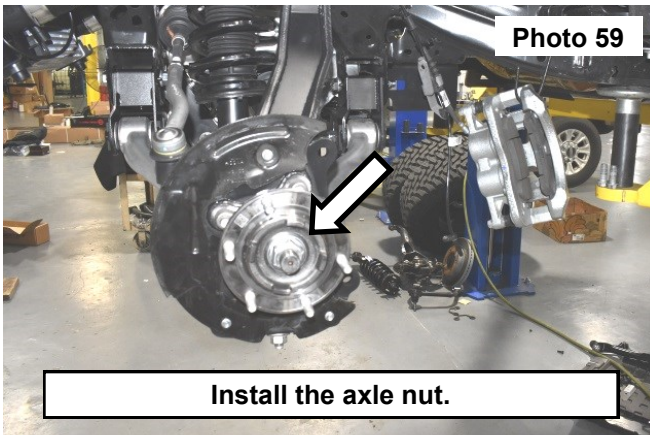



57. Install the caliper onto the rotor and the knuckle. secure using the (2) retained bolts. Torque to 130 ft-lbs. use an 18mm socket. **See Photo 61.**
58. Install the ABS sensor in the knuckle and use the retained bolt. Tighten using an 8mm socket. **See Photo 62.**

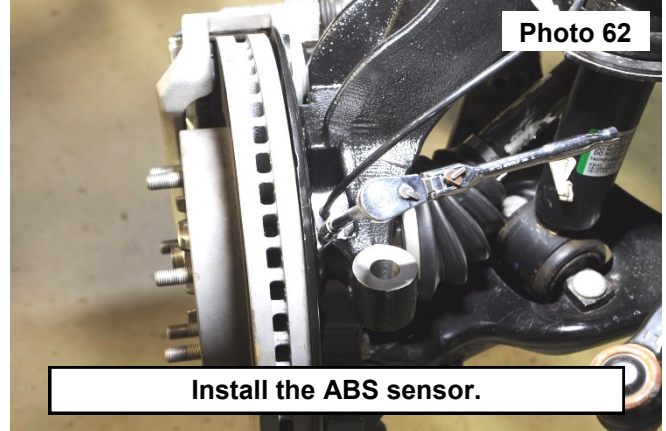
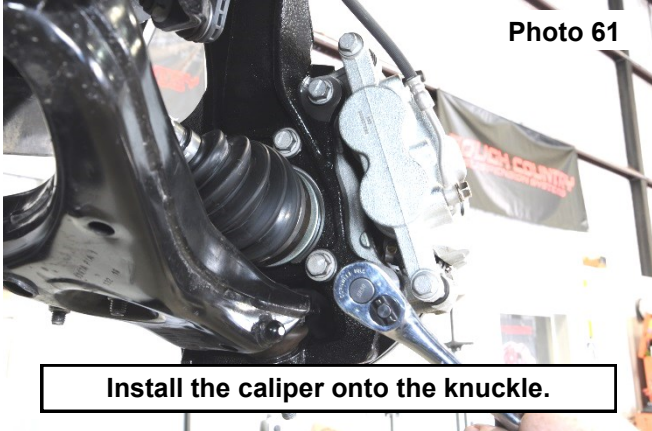

59. Install the ABS line mount onto the rear side of the knuckle, secure using the retained bolt. Tighten using a 10mm socket. **See Photo 63.**
60. Install the sway bar link into the lower control arm using the stock hardware. **See Photo 64.**

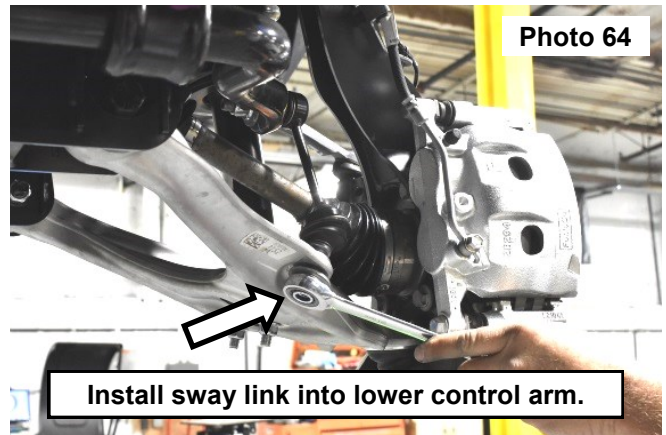
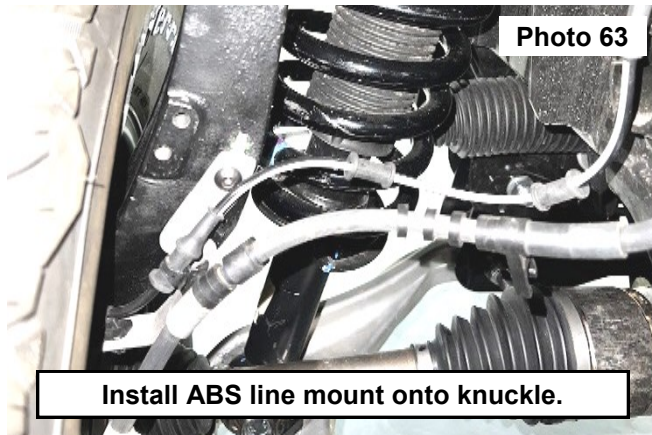

61. Install the tie rod end into the knuckle with the retained nut using a 15mm wrench. **See Photo 65.**
62. Connect the (3) EPAS (Electronic Power Assist Steering) plugs as shown located on the steering assembly. **See Photo 66.**

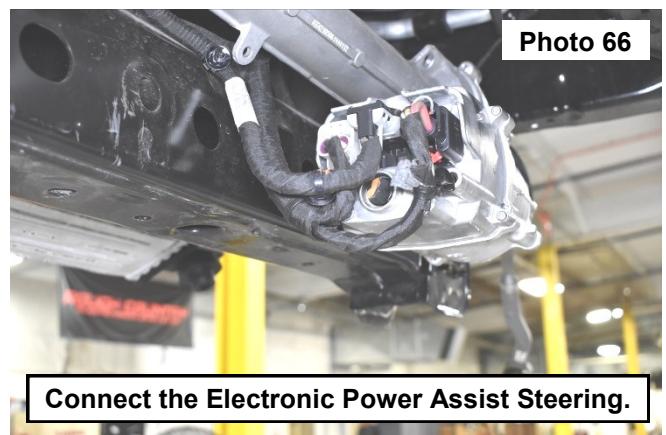
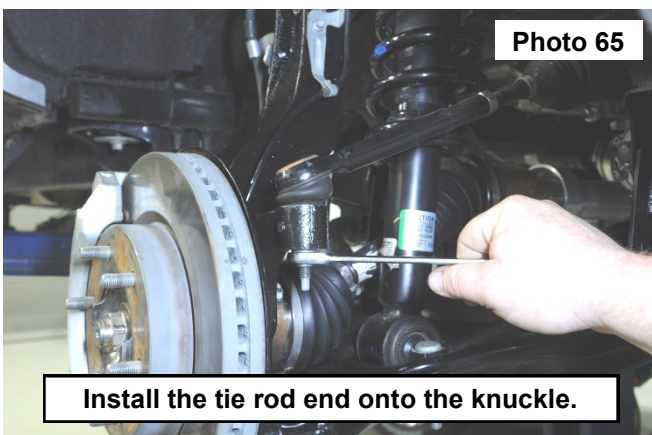

63. Put on wheels and lower.
64. Tighten all hardware.



## REAR INSTALLATION INSTRUCTIONS

1. Jack up the rear of the vehicle and place on jack stands. Remove the rear wheels.
2. Remove the track bar using a 24mm socket/wrench. **See Photo 1.**
3. Support the axle and remove the lower strut bolt using a 1-1/16" socket/wrench. **See Photo 2.**

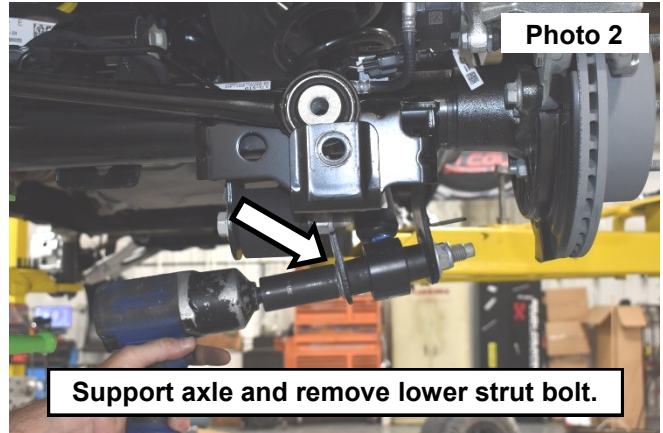
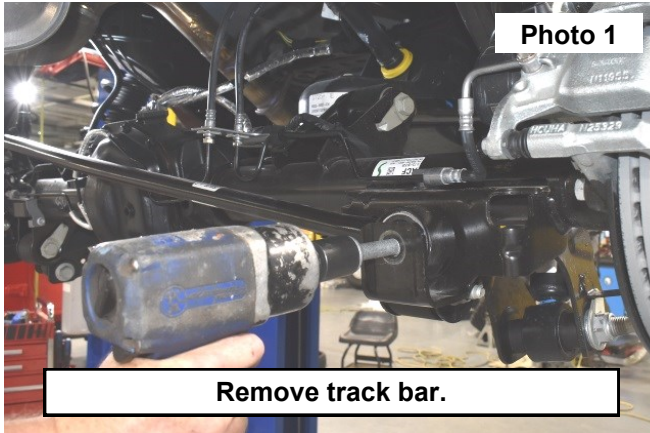

4. Remove the ABS/emergency wiring harness from the differential using an 8mm socket/wrench. **See Photo 3.**
5. Remove the clip holding the inner fender using a screw driver. **See Photo 4.**

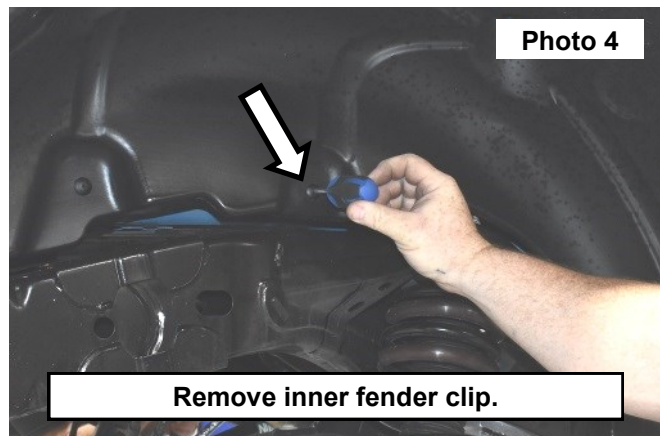
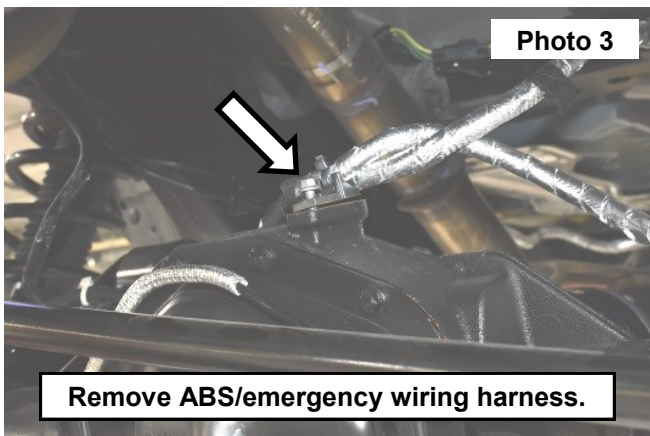

6. Remove the upper strut nuts using a 15mm wrench and remove strut from vehicle. **See Photo 5.**
7. Remove the roll pin from the strut. **See Photo 6.**

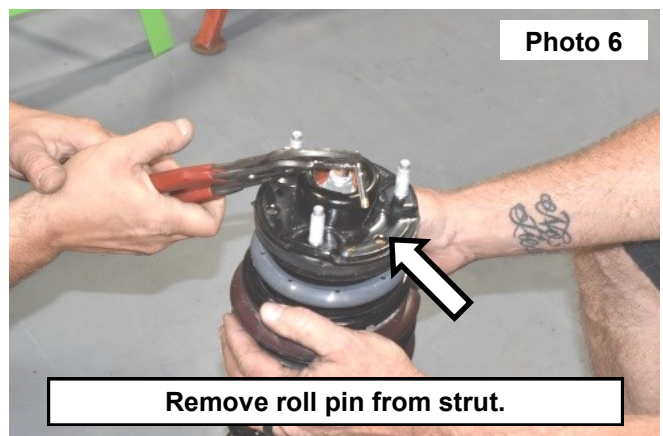
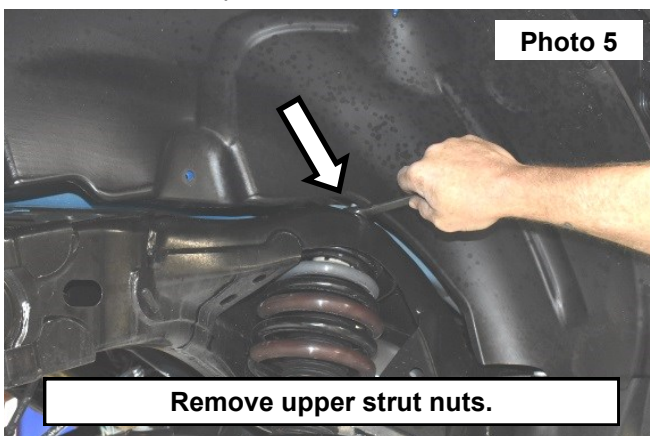



8. Install the 10mm studs in the upper strut spacer and install spacer on the strut using stock hardware. **NOTE: Spacer needs to be angled with the tall side towards the rear. See Photo 7.**
9. Reinstall the strut with the spacer using the 10mm hardware and 17mm wrench. **See Photo 8.**

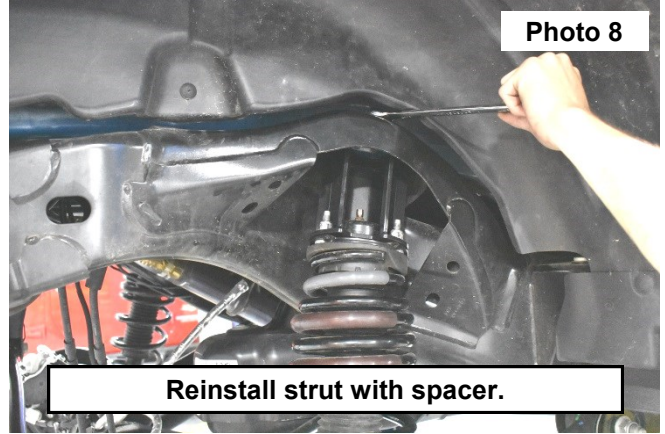
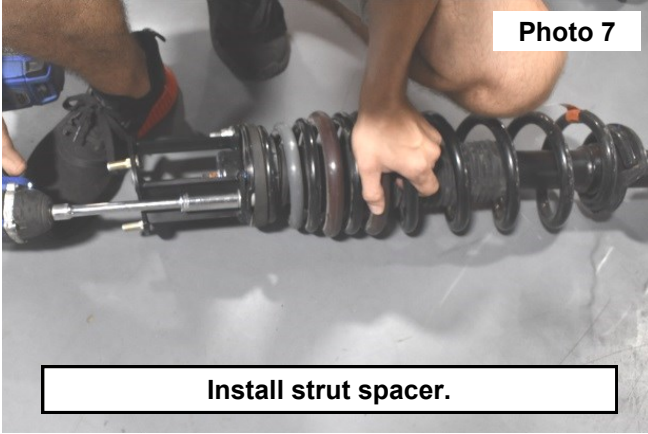

10. Remove the push pin clamp from the upper brake line bracket and remove the brake line bracket bolt. **See Photo 9.**
11. Remove the washers from the brake line bracket and lower the brake line through the bracket. **See Photo 10.**

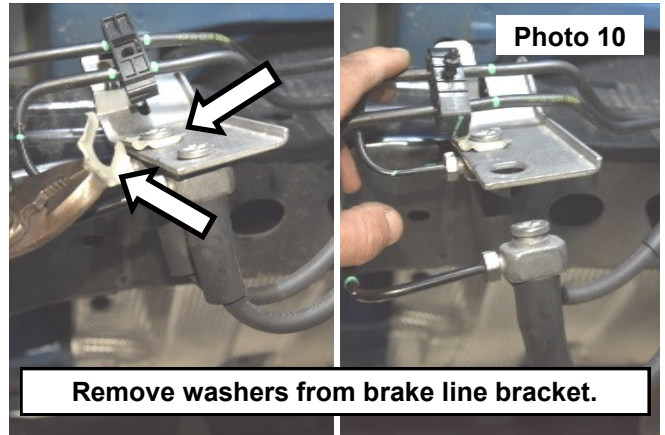
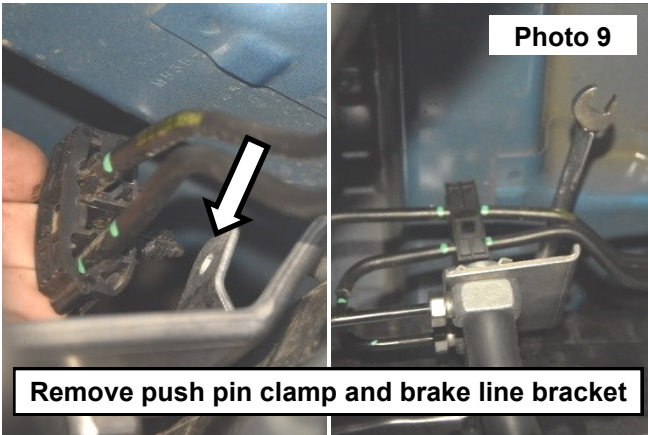

12. Install the supplied brake line bracket using the 5/16" hardware and reinstall push pin clamp. **See Photo 11.**
13. Reinstall the brake line into the new bracket and insert the stock washers to secure. **See Photo 12.**

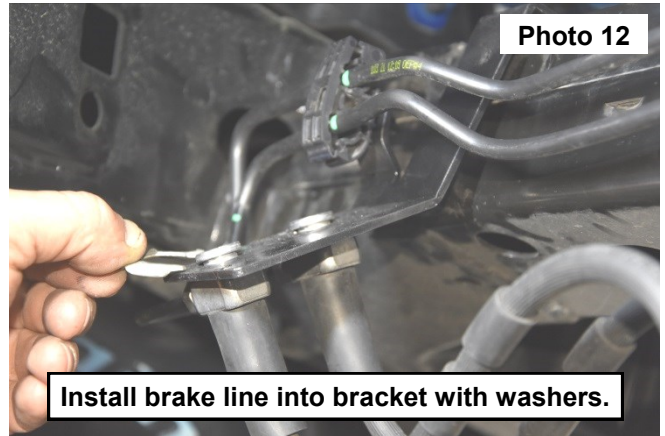
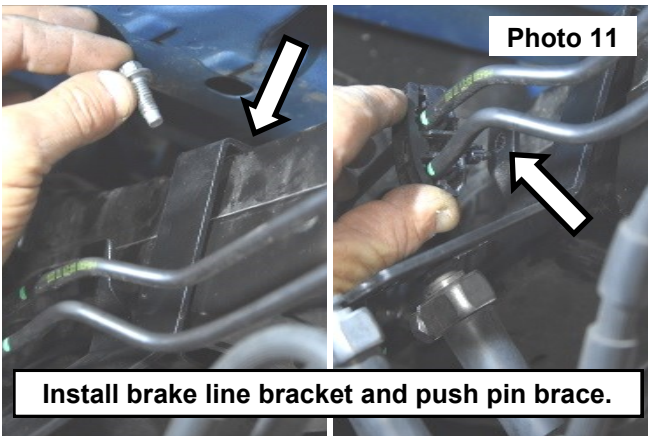

14. Install the track bar relocation bracket. **See Photo 13.**  
15. Mark the axle through the hole in the drop bracket. **See Photo 14.**

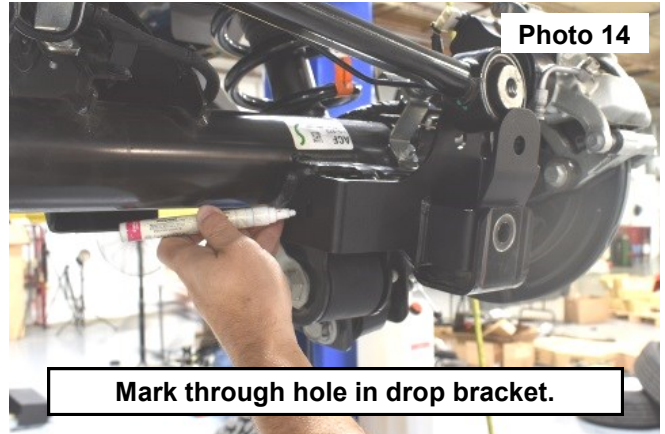
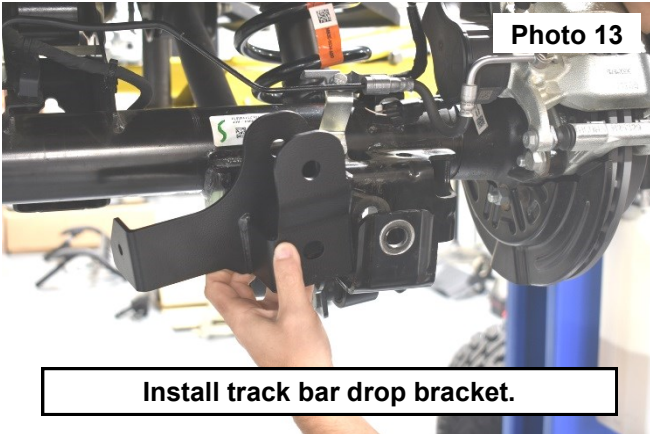

16. Remove bracket and drill a hole where marked using a 13/32" drill bit. **See Photo 15.**  
17. Reinstall the track bar relocation bracket using the stock bolt. **See Photo 16.**

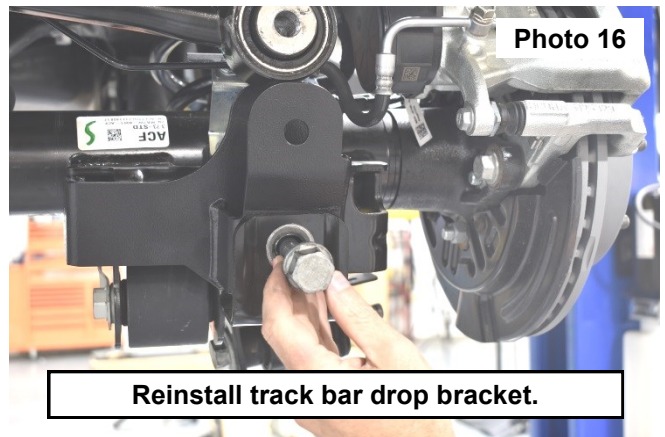
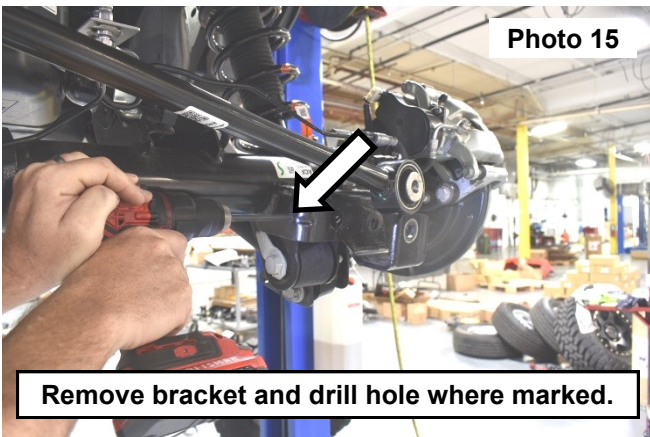

18. Install the 3/8" hardware in drilled hole to the relocation bracket using two 9/16" socket/wrenches. **See Photo 17.**  
19. Install the track bar to the relocation bracket using the 5/8" hardware and 15/16" socket/wrench. **See Photo 18.**

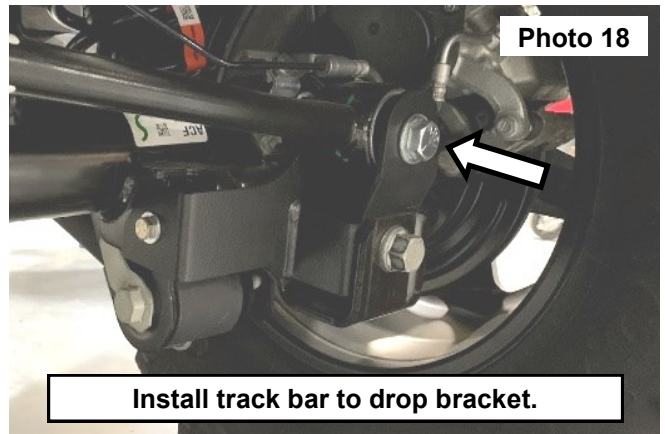
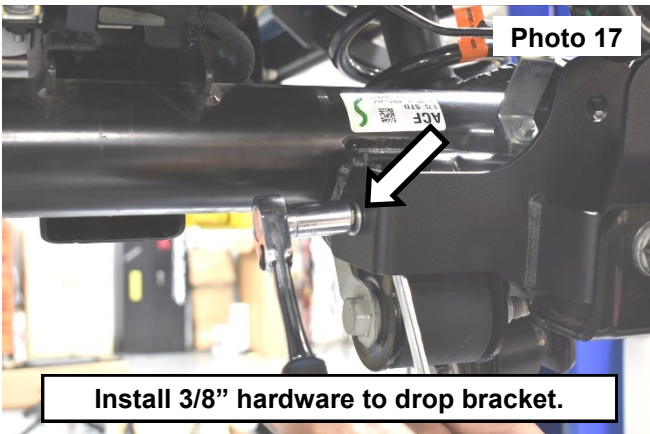



20. Remove the brake line bracket from the axle using a 10mm socket/wrench. **See Photo 19.**
21. Install the brake line drop bracket using the stock bolt at the axle and the supplied 5/16" x 3/4" bolt, nut, and washers at the bracket using a 1/2" socket/wrench. **See Photo 20.**

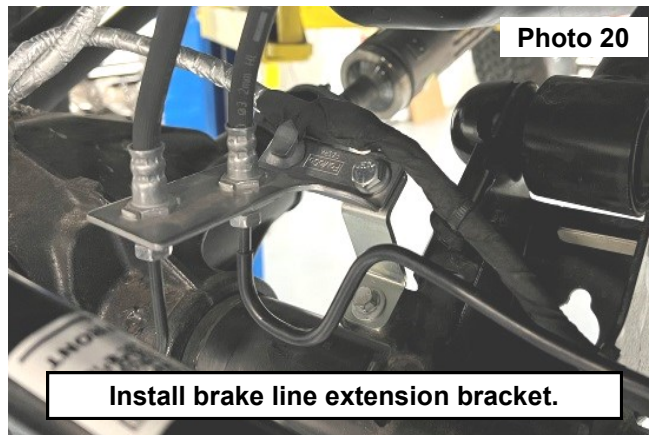
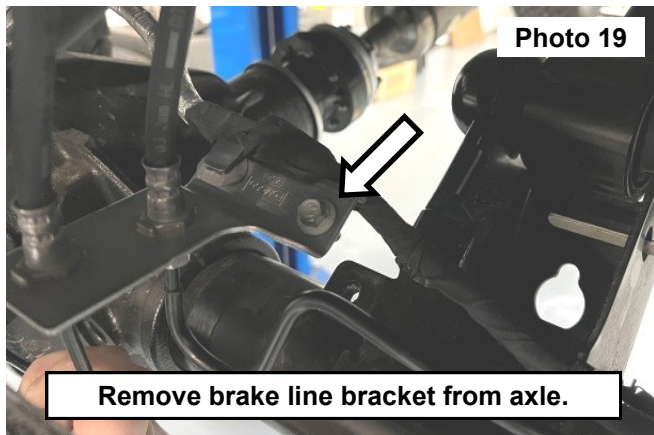

22. Reassemble the rear suspension in reverse order of the disassembly.
23. Put on wheels and lower.



By purchasing any item sold by Rough Country, LLC, the buyer expressly warrants that he/she is in compliance with all applicable, State, and Local laws and regulations regarding the purchase, ownership, and use of the item. It shall be the buyers responsibility to comply with all Federal, State and Local laws governing the sales of any items listed, illustrated or sold. The buyer expressly agrees to indemnify and hold harmless Rough Country, LLC for all claims resulting directly or indirectly from the purchase, ownership, or use of the items.







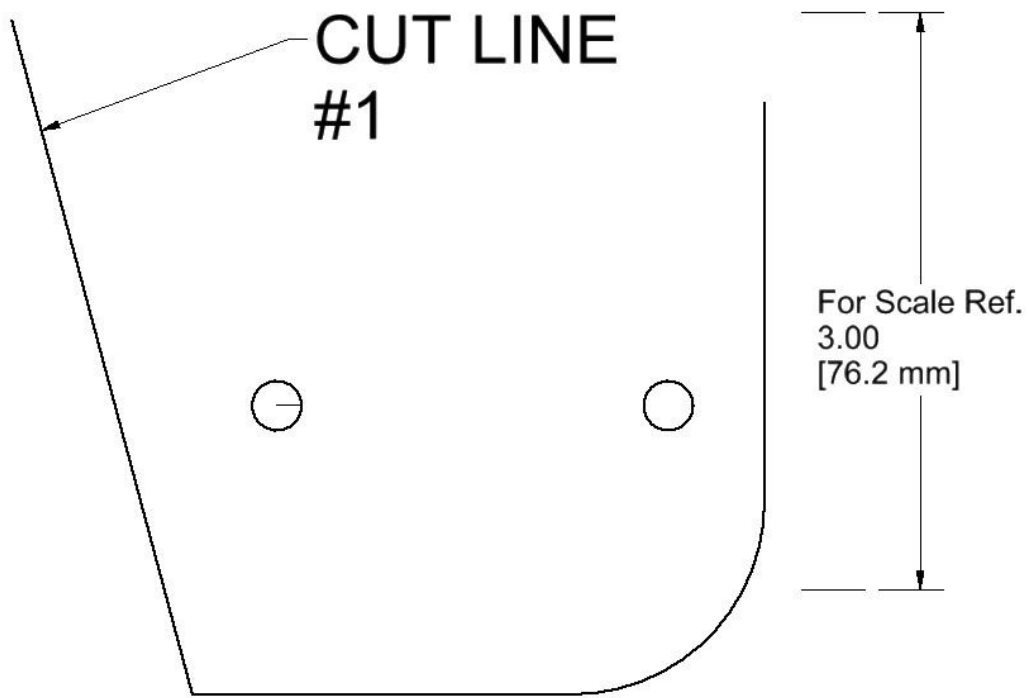





Mark at arrows when template is on the vehicle.

