

INSTALLATION GUIDE

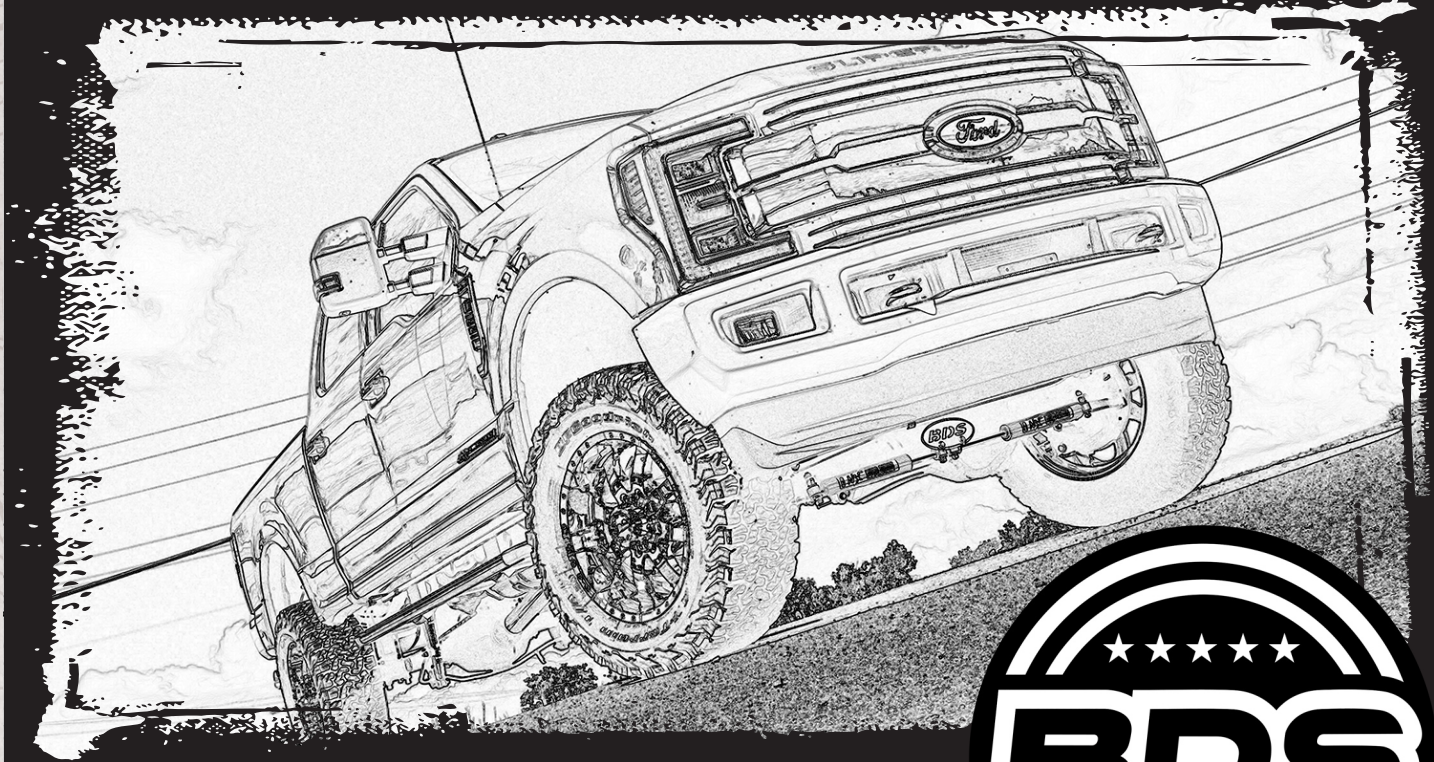

Part#: 013414



HARDCORE LIMITED LIFETIME WARRANTY

4"/5" Suspension System

Ford Super Duty 4WD | 2017-2023

Rev. 072823

491 W. Garfield Ave., Coldwater, MI 49036 • Phone: 517-279-2135

E-mail: tech-bds@ridefox.com

Read And Understand All Instructions And Warnings Prior To Installation Of System And Operation Of Vehicle.



THANK YOU

Your truck is about to be fitted with the best suspension system on the market today. That means you will be driving the baddest looking truck in the neighborhood, and you'll have the warranty to ensure that it stays that way for years to come.

Thank you for choosing BDS Suspension!

BEFORE YOU START

BDS Suspension Co. recommends this system be installed by a professional technician. In addition to these instructions, professional knowledge of disassembly/ reassembly procedures and post installation checks must be known.

FOR YOUR SAFETY

Certain BDS Suspension products are intended to improve off-road performance. Modifying your vehicle for off-road use may result in the vehicle handling differently than a factory equipped vehicle. Extreme care must be used to prevent loss of control or vehicle rollover. Failure to drive your modified vehicle safely may result in serious injury or death. BDS Suspension Co. does not recommend the combined use of suspension lifts, body lifts, or other lifting devices. You should never operate your modified vehicle under the influence of alcohol or drugs. Always drive your modified vehicle at reduced speeds to ensure your ability to control your vehicle under all driving conditions. Always wear your seat belt.

BEFORE INSTALLATION

- Special literature required: OE Service Manual for model/year of vehicle. Refer to manual for proper disassembly/reassembly procedures of OE and related components.
- Adhere to recommendations when replacement fasteners, retainers and keepers are called out in the OE manual.
- Larger rim and tire combinations may increase leverage on suspension, steering, and related components. When selecting combinations larger than OE, consider the additional stress you could be inducing on the OE and related components.
- Post suspension system vehicles may experience drive line vibrations. Angles may require tuning, slider on shaft may require replacement, shafts may need to be lengthened or trued, and U-joints may need to be replaced.
- Secure and properly block vehicle prior to installation of BDS Suspension components. Always wear safety glasses when using power tools.
- If installation is to be performed without a hoist, BDS Suspension Co. recommends rear alterations first.
- Due to payload options and initial ride height variances, the amount of lift is a base figure. Final ride height dimensions may vary in accordance to original vehicle attitude. Always measure the attitude prior to beginning installation.



Visit 560plus.com for more information.

BEFORE YOU DRIVE

TIRES AND WHEELS

37 x 12.50 w/17 x 9 and 4.5" - 5" back spacing
37 x 12.50 w/18 x 9 and 4.5" - 5" back spacing
37 x 12.50 w/20 x 9 and 4.5" - 5" back spacing

Trimming may be required



Check all fasteners for proper torque. Check to ensure for adequate clearance between all rotating, mobile, fixed, and heated members. Verify clearance between exhaust and brake lines, fuel lines, fuel tank, floor boards and wiring harness. Check steering gear for clearance. Test and inspect brake system.

Perform steering sweep to ensure front brake hoses have adequate slack and do not contact any rotating, mobile or heated members. Inspect rear brake hoses at full extension for adequate slack. Failure to perform hose check/ replacement may result in component failure. Longer replacement hoses, if needed can be purchased from a local parts supplier.

Perform head light check and adjustment.

Re-torque all fasteners after 500 miles. Always inspect fasteners and components during routine servicing.

CONTENTS OF YOUR KIT

BDS013414 Box Kit

Part #	Qty	Description
083404R	1	Pitman Arm
02998	1	Drv Brakeline Bracket - 2017 SD
02999	1	Pass Brakeline Bracket - 2017 SD
01001	2	Front Bump Stop Extension - 4"
01044	1	Sway Bar Drop - Drv
01045	1	Sway Bar Drop - Pass
03412	1	Track Bar Bracket
B1181		Bag Kit - 2017 Superduty
02019	2	Track Bar Cam Washer
64084	1	1/8" x 1-1/8" cotter pin
099000	4	Zip Tie
099002	2	Zip Tie
422	1	Bolt Pack - Sway Bar Drop Bracket
	4	3/8"-16 x 1-1/4" bolt grade 8
	4	3/8"-16 prevailing torque nut
	8	3/8" USS flat washer thru-hardened
606	1	Bolt Pack - Bump Stops
	2	5/16"-18 x 1-1/4" bolt grade 5
	2	5/16"-18 prevailing torque nut
	4	5/16" SAE washer

BDS123251 Box Kit

Part #	Qty	Description
A241	1	Superduty Radius Arm Assembly - DRV
A242	1	Superduty Radius Arm Assembly - Pass
B1114		Bag Kit - Radius Arms
02421	4	Radius Arm Cam Plates
02002ZP	2	18mm x 150mm bolt
N18MPT	2	18mm Prevailing Torque Nut
S34SAE	4	3/4" SAE Washer

BDS033411 Diesel Box Kit or

Part #	Qty	Description
033411R	2	4" Coil Spring - Diesel

BDS033412 Gas Box Kit

Part #	Qty	Description
033412R	2	4" Coil Spring - Gas

BDS013459 Rear Box Kit (2020)

Part #	Qty	Description
03951	2	4.5" Rear Super Duty Block
583181600SB	4	5/8 x 3-1/8 x 16 semi-round u-bolt
B218		Bag Kit - 5/8" U Bolts
W58SB	8	5/8 washer
N58FHB	8	5/8 high nut

BDS85431 Box Kit

Part #	Qty	Description
15621	1	Stabilizer
SB58BK	2	Bushing - EB1
45313	1	Narrow Sleeve
P00932	1	P Pack - Stabilizer
01504	1	Stabilizer Bracket
561140200RB	2	5/16" x 1-1/4" x 2" Round U-bolt
308	1	Bolt Pack - u-bolts
	4	1/4" USS washer thru hardened
	4	5/16"-18 prevailing torque nut
312	1	Bolt Pack Stabilizer Mounting
	1	3/8"-16 x 2-1/2" bolt grade 5
	1	3/8"-16 prevailing torque nut
	2	3/8" SAE flat washer

BDS013517 Rear Box Kit (2017-2019)

Part #	Qty	Description
03410	1	5" rear Superduty tapered (DRV)
03411	1	5" rear Superduty tapered (PASS)
583181600SB	4	5/8 x 3-1/8 x 16 semi-round u-bolt
B218		Bag Kit - 5/8" U Bolts
W58SB	8	5/8 washer
N58FHB	8	5/8 high nut

123263 - Radius Arm Box Kit (2023)

Part #	Qty	Description
A444	1	2023 Radius Arm Assembly - DRV Side
05356	1	2023 Super Duty Radius Arm- Drv
868190	1	Ford F250 Control Arm Bushing
A445	1	2023 Radius Arm Assembly- PASS side
05357	1	2023 Super Duty Radius Arm- Pass
868190	1	Superduty Bushing
02802	2	BDS Badge
995	1	Rivet Bolt Pack
05358	4	3 Position Radius Arm Cam
02002ZP	2	M18-2.5 x 150 Bolt
N18MPT	2	M18-2.5 Lock Nut
W34SAE	4	3/4" SAE flat washer
099000	4	Zip Ties
099002	2	Push Pin Zip Ties

TROUBLESHOOTING INFORMATION FOR YOUR VEHICLE

1. *This kit is not compatible with trucks equipped with radius arm mounted ride height sensors.*
2. Ford recommends replacement of the pitman arm nut once it has been removed due to degradation of the pre-applied dry thread adhesive. BDS supplies new thread locker for use with the original nut. Care must be taken to ensure the sector shaft and nut threads are clean for proper adhesion. The nut requires 350 ft-lbs of torque, ensure the tools used are adequate to hit this specification.
3. Use a small pitman arm puller to remove the drag link joint and steering stabilizer taper.
4. Larger tires on stock wheels are not recommended due to brakeline clearance required. Use recommended specifications listed in tire and wheel fitment section.
5. Ensure the correct U-bolt length for the rear suspension configuration on your vehicle. Use the information provided below along with the diagram shown in Figure A to determine your rear leaf spring setup. (2017-2019) 2020 Model years: Use 16" U-bolt

Bottom overload, 2 leaf main pack, no top overload	16" U-Bolt
Bottom overload, 2 leaf main pack, with top overload	16" U-bolt
Bottom overload, 3 or more* leaf main pack, no top overload	16" U-bolt
Bottom overload, 3 or more* leaf main pack, with top overload	19" U-bolt

*Variations with additional add-a-leaves or larger top mounted overload spacer may require longer u-bolts than provided, order separately.

FIGURE A

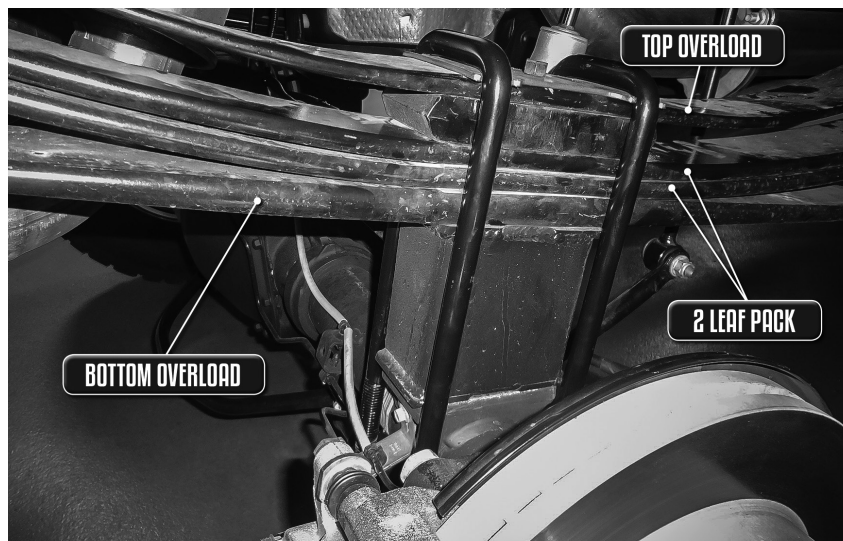

INSTALLATION INSTRUCTIONS

FRONT INSTALLATION

1. Park the vehicle on a clean, flat surface and block the rear wheels for safety.
2. Disconnect the front track bar from the frame mount. Retain hardware.
3. Raise the front of the vehicle and support under the frame rails with jack stands.



Tip As a result of the location of the long radius arm suspension, support locations are limited. Use your best judgment while supporting the vehicle with sufficient strength stands at appropriate locations. The radius arms will need to move freely during this installation.

SPECIAL TOOLS

Large Pitman Arm Puller
 Small Pitman Arm Puller
 Large Torque Wrench, ability to torque to 405 ft-lbs.

4. Remove the front wheels.
5. Support the front axle with a hydraulic jack.
6. Disconnect the front brake line brackets from the axle (Fig 1). Retain hardware.

FIGURE 1

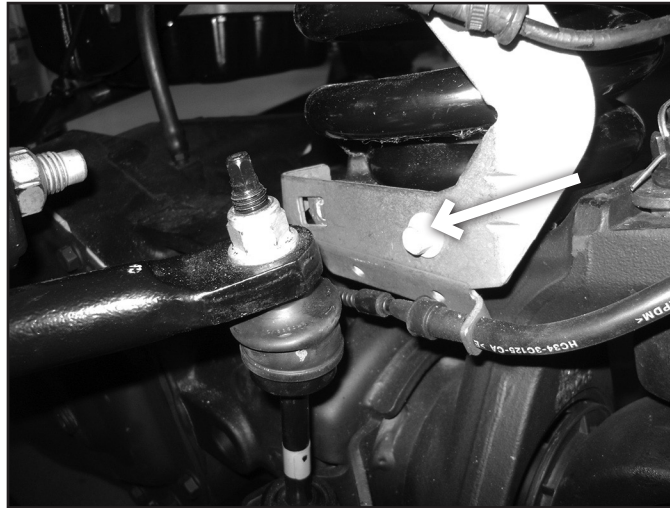

7. Remove the clips holding the front brake lines to the brackets on the frame. Carefully cut the factory bracket so that the brake line can be removed without breaking loose the fittings. Remove the factory brackets from the vehicle. Do not damage the brakeline!

FIGURE 2A

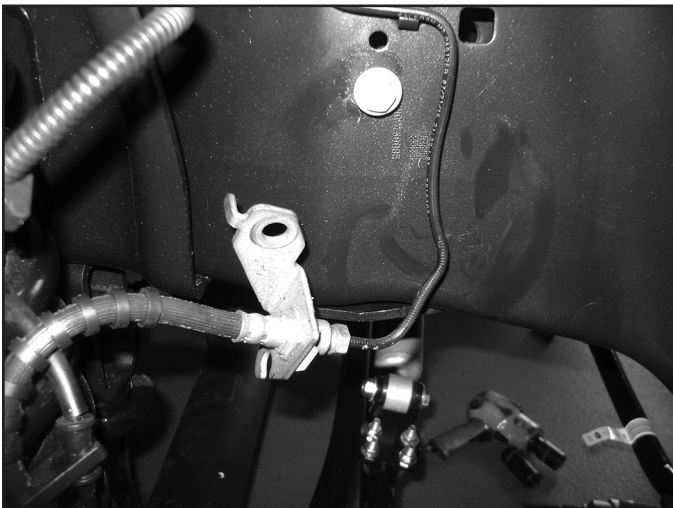
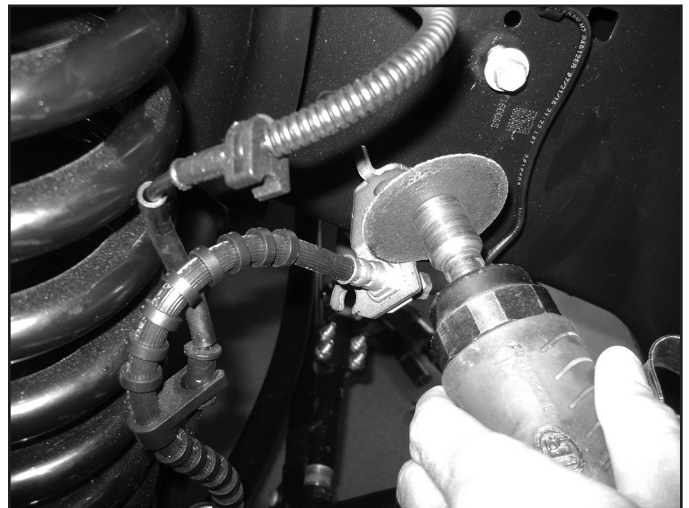

FIGURE 2B



8. Free the hub vacuum lines from the axle to allow for adequate droop (Fig 3, 4).

FIGURE 3



FIGURE 4



9. Disconnect the sway bar end links from the sway bar. Retain hardware.
10. Remove the lower OE shock hardware at this time (leave upper attached). Retain lower mounting hardware.
11. Lower the axle until the OE coil springs are free and remove the springs from the vehicle. Retain the upper spring isolator for use with the new springs. Once coils are removed, reattach the axle to the shocks.

! Caution *Do not over extend the brake lines. Once the coil springs are removed, hook the front shocks back up by reinstalling the bolt, do not install the nut. This is a safety measure to hold the axle in place while the replacement radius arms are installed.*

STEERING

12. Disconnect the OE steering stabilizer from the frame mount. Disconnect the stabilizer from the factory drag link.



Tip *It is easiest to get the taper to break free from the drag link by using a small pitman arm puller. Stock stabilizer will not be reused.*

13. Disconnect the (5) bolts mounting the OE track bar bracket to the frame. Remove bracket and retain hardware.
14. Disconnect the drag link from the pitman arm. Retain hardware. Free the drag link from the pitman arm with appropriate tool.



Tip *The same small pitman arm puller works well.*

15. Remove the pitman arm nut. Note the indexing of the pitman arm in relation to the steering sector shaft and remove the pitman arm from the steering box using the appropriate puller.
16. Remove all of the dri-lock compound on the threads of the OE nut and steering sector shafts. Apply a bead of the supplied thread locker all the way around the threads of the OE nut.



! Caution *It is important to apply thread locker to the entire thread surface of the nut and ensure the threads are clean to promote good adhesion with enough surface area to keep the nut from loosening.*

17. Install the new pitman arm (indexed the same as the OE) and fasten with the OE nut. Torque the nut to 350 ft-lbs.



! Caution *Ensure the tool used is adequate to torque the nut to this specification. Failure to do so can result in the nut loosening and possible failure of the sector shaft or nut.*

18. Install the new track bar bracket (03412) using the stock mounting hardware as it was removed (Fig 5). Torque all (5) mounting bolts to 129 ft-lbs. It may be necessary to form the stock hard line slightly to clear the new trackbar bracket.

FIGURE 5

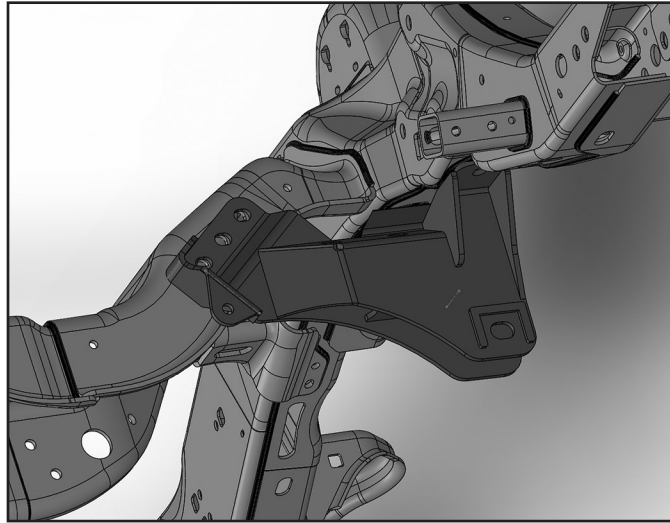

BUMP STOP MODIFICATION

19. Pull the OE front bump stops free from the bump stop cups and remove the bolt mounting the cup to the frame (Fig 6).

FIGURE 6



20. Position the cup on the provided bump stop extension, attach with 5/16" hardware from bolt pack #606. The alignment tab on the bump stop cup will fit in the second hole in the extension. Tighten to 30 ft-lbs.
21. Install bracket and bump stop with factory hardware in the original hole. Use thread locker on the threads and torque to 20 ft-lbs (Fig 7).

FIGURE 7

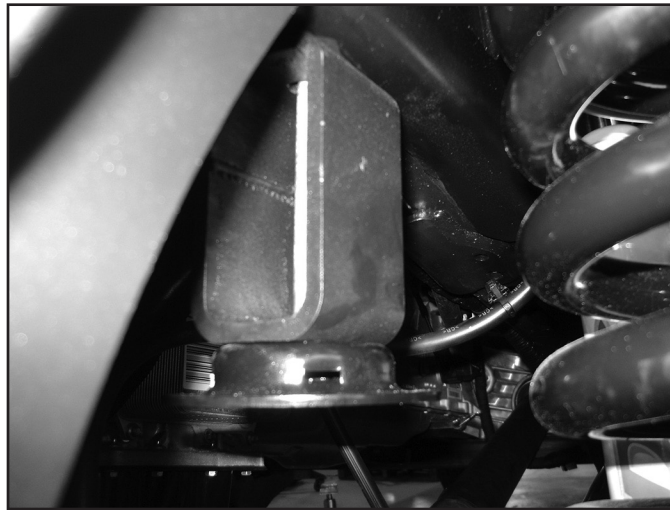

RADIUS ARM INSTALLATION:

22. Work on one side of the vehicle at a time. Loosen the four radius arm-to-axle mounting bolts but do not remove. Once again, ensure that the front axle is well supported. Disconnect vacuum line and axle vent tube from radius arm.

2017-2022

23. Starting with the driver's side, remove radius arm hardware. Remove the radius arm from the vehicle. Install new radius arm on driver's side with the cam forward using the provided 18mm bolt, washer, and nut. Use the factory hardware in the upper hole and radius arm pivot.. It may be necessary to remove one of the passenger's side axle bolts to allow the axle to rotate to hook up the arm completely. (Fig 8)

FIGURE 8

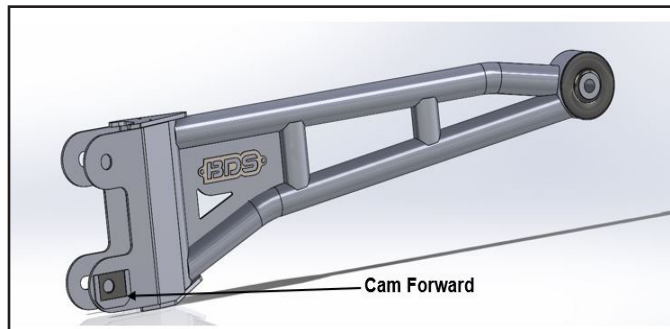

24. Repeat installation of new radius arm on the passenger's side. Tighten axle hardware to 240 ft-lbs (4 plc). Do not tighten the frame mounting brackets at this time. Reattach vacuum lines to new radius arm using provided christmas tree zip ties.
25. The BDS badge can now be riveted on to each radius arm using the included 1/8" rivets.

2023

Radius arms are side specific. The top of the radius arm is flat. When looking from above, the axle side will be offset inward towards the center of the vehicle.

26. Starting with the driver's side, remove radius arm hardware. Remove the radius arm from the vehicle. Install new radius arm on driver's side with the cam centered using the provided 18mm bolt, washer, and nut. Use the factory hardware in the upper hole and radius arm pivot. It may be necessary to remove one of the passenger's side axle bolts to allow the axle to rotate to hook up the arm completely.
27. Install the cam washer with the hole centered. (Fig. 9)

FIGURE 9

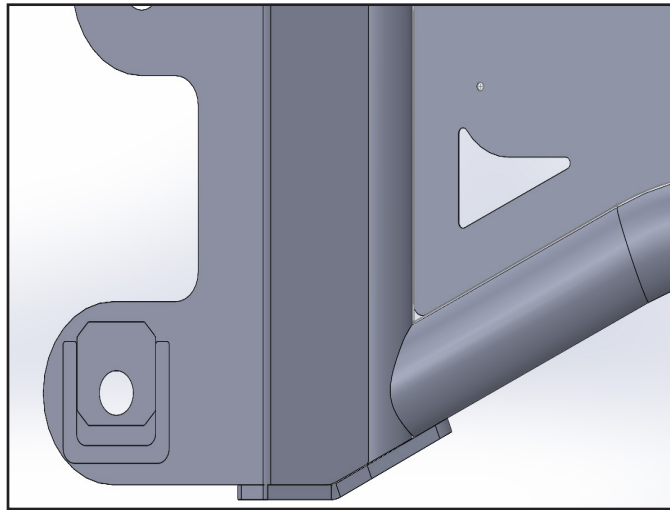

28. Repeat installation of new radius arm on the passenger's side. Tighten axle hardware to 240 ft-lbs (4 plc). Do not tighten the frame mounting brackets at this time. Reattach vacuum lines to new radius arm using provided christmas tree zip ties.
29. The BDS badge can now be riveted on to each radius arm using the included 1/8" rivets.

COIL SPRING INSTALLATION (COILOVER INSTALLATION SEE SEPARATE INSTRUCTION SHEET):

30. Remove the front shocks from the vehicle completely at this time.
31. Lower the axle enough to allow the coils to be installed. Do not over extend the brake lines. Check ABS, brake, and vacuum lines to ensure they are not overstretched.
32. Install new coils with factory isolators. Raise the axle to seat the coil springs, rotate the spring so that it seats in the bottom coil perch correctly.
33. Grease and install sleeves and bushings into the shocks.
34. BDS (Silver / non-Fox) shocks will require the lower mount to be modified. The sharp, non-formed edge will need to be ground to match the formed profile. Grind this and coat with paint. (Fig 10a, 10b)

FIGURE 10A

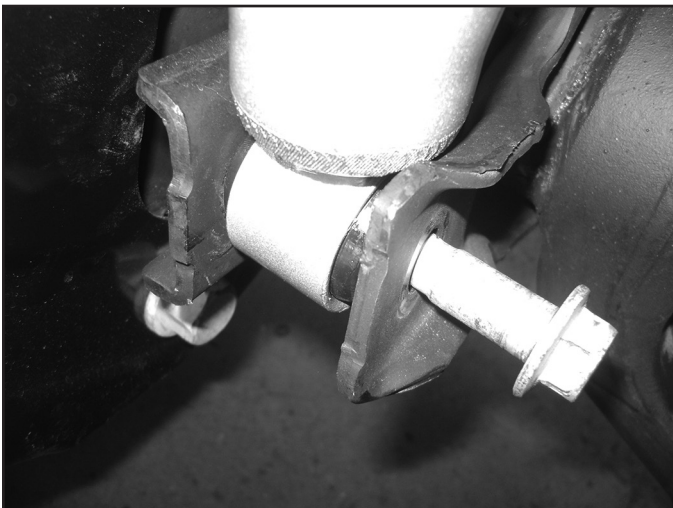
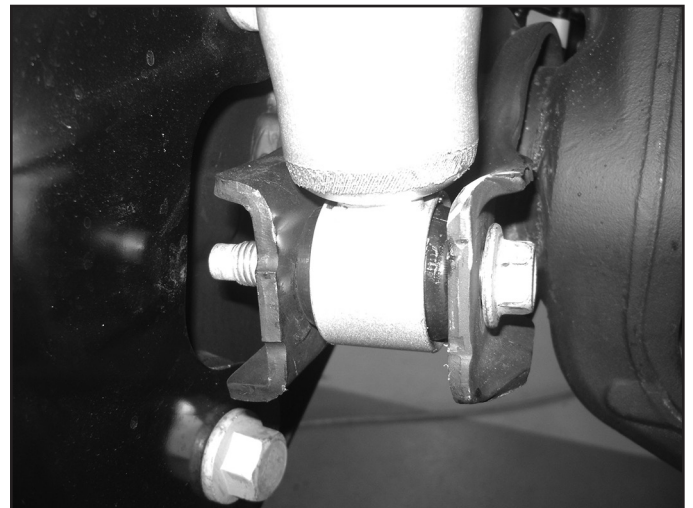

FIGURE 10B



35. Compress the coils slightly by using a hydraulic jack on the axle. Install new shocks with factory lower hardware and stem washers, bushings, and 1/2" fine thread nut on the upper mount. Tighten the upper mount until the bushings begin to swell. Tighten lower mount to 50 ft-lbs.
36. Reattach the factory brakeline brackets to the lower coil seat with factory hardware at this time.

SWAY BAR

37. Note the orientation of the front sway bar (top versus bottom). Disconnect the sway bar from the frame and remove from the vehicle. Retain hardware.
38. Install the provided sway bar drop bracket (01044 / 01045) to the original sway bar frame mounting locations with the original hardware. Mount the drop bracket with the open face toward the inside of the vehicle and the bracket offset toward the front. Torque hardware to 30 ft-lbs.
39. Attach the sway bar to the new drop brackets in the correct orientation with the 3/8" hardware from bolt pack #422. Torque hardware to 30 ft-lbs (Fig 11).

FIGURE 11

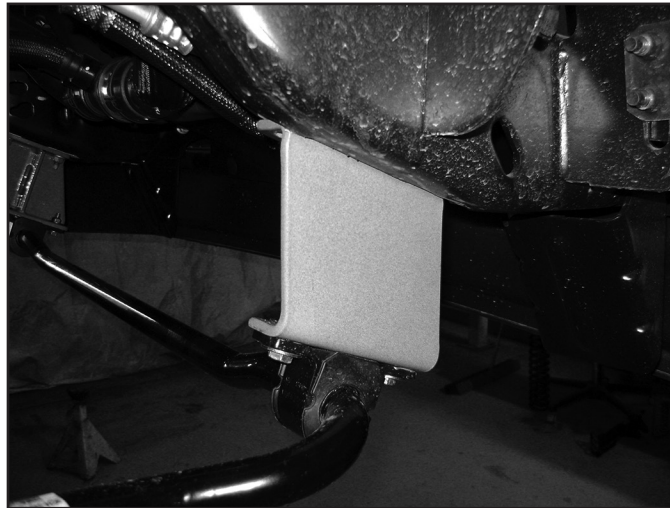

40. Install the sway bar link ends to the sway bar and secure with the OE hardware. Torque to 90 ft-lbs.

BRAKE LINE / ABS / VACUUM:

41. Attach the vacuum line to the lower coil seat bracket with included push pin zip tie. (Fig 12)

FIGURE 12

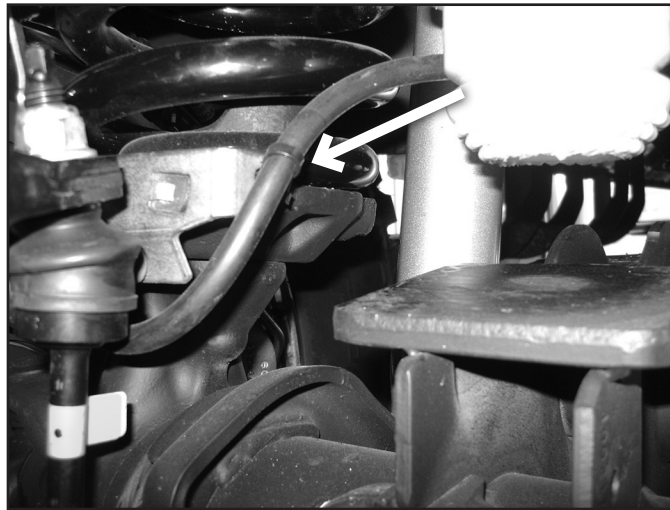

42. Install the new brake line brackets, brackets are side specific. Brake lines will need to be reformed to reach the new mounting position. It may be necessary to slightly twist the brakeline fittings in relation to the hardline to get adequate clearance to the frame / wheel and tire. Attach the ABS wire to the driver's side with 1/4" hardware with rubber coated cable clamp (Fig 13a, 13b)

FIGURE 13A - PASSENGER'S

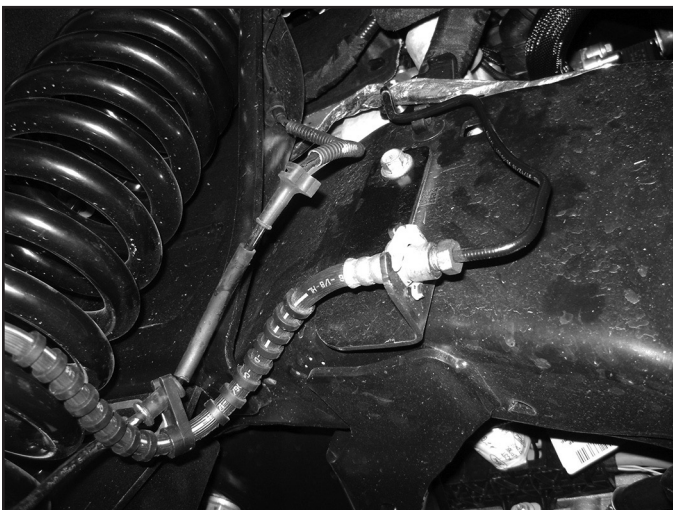
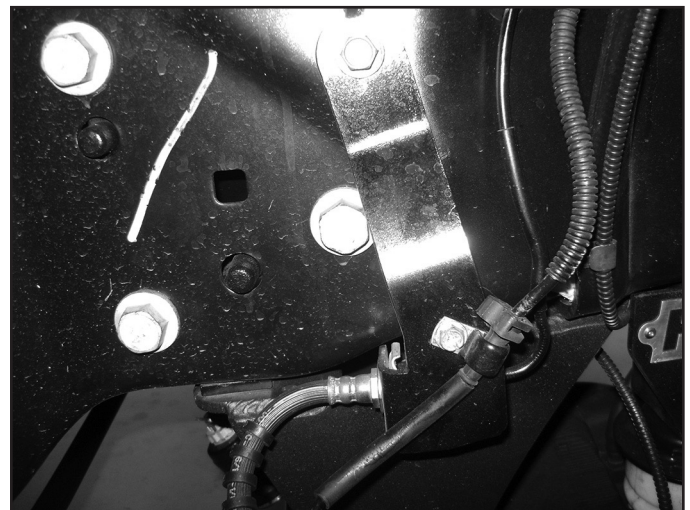

FIGURE 13B - DRIVER'S



43. Reattach the steering drag link to the pitman arm. The drag link adjuster will need to be loosened on the passenger side in order to flip the drag link upside down to install into the pitman arm. Torque nut to 148 ft-lbs. Install the original castellated nut cap and new 1/8" cotter pin.
44. Center the steering wheel. Extend the steering stabilizer 4-1/2" to 4-3/4" and attach to the frame end with stud pack in the stabilizer box kit. Attach stabilizer bracket to the drag link with the included u-bolts, washers, and nuts. Attach stabilizer to bracket with 3/8" hardware. Tighten 5/16" hardware to 15 ft-lbs, 3/8" to 35 ft-lbs, 7/16" Stud nut to 45 ft-lbs, and 1/2" stud nut to 65ft-lbs. (Fig 14a, 14b)

FIGURE 14A



FIGURE 14B

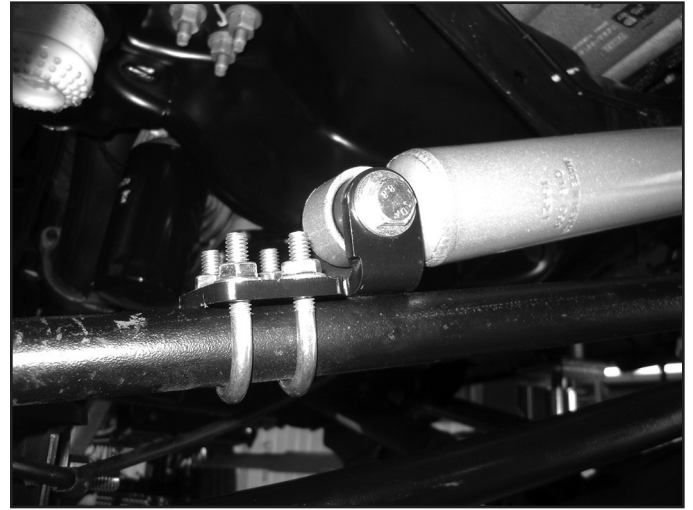

45. Install the wheels and lower the vehicle to the ground.
46. Attach the track bar to the new bracket with the OE hardware. Turn the steering wheels to aid in aligning the track bar in the bracket. Install the provided cam washers between the alignment tabs on the bracket. Position the cam washers so that the hole is closer to the driver's side (Fig 15) for 4" kits. Torque hardware to 405 ft-lbs.



Tip *Due to variations in trucks, it may be necessary to rotate the cams 180 degrees to have the axle more centered.*

47. Torque radius arm frame pivot bolts to 221 ft-lbs.

FIGURE 15 - OFFSET TOWARDS DRIVER'S SIDE



REAR INSTALLATION

48. Raise the rear of the vehicle and support with jack stands under the frame rails just ahead of the spring hangers.
49. Remove the wheels.
50. Support the axle with a hydraulic jack.
51. Remove the OE shocks. Retain all mounting hardware.

BLOCK KITS ONLY

52. Support the rear axle with a hydraulic jack. Disconnect the passenger's side spring u-bolts. Loosen the driver's side to allow the axle to droop out.
53. Lower the axle and remove the factory lift block. It will not be reused.

54. Lower the axle enough to place the provided lift block between the axle and the leaf spring. Position the block so the bump stop wing faces inward, and the small side of the block faces forward. (Fig 16)

FIGURE 16

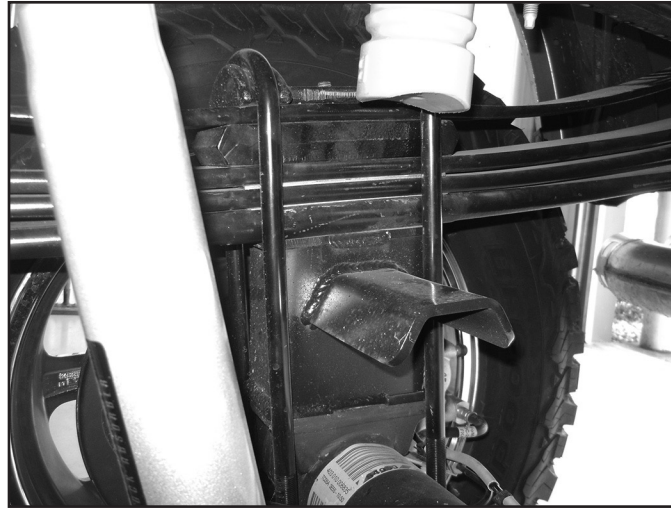

55. Raise the axle to engage the block spring alignment pins. Fasten the entire assembly with the provided u-bolts, washers, and nuts. Snug but do not torque the u-bolts at this time. (Fig 17)

FIGURE 17

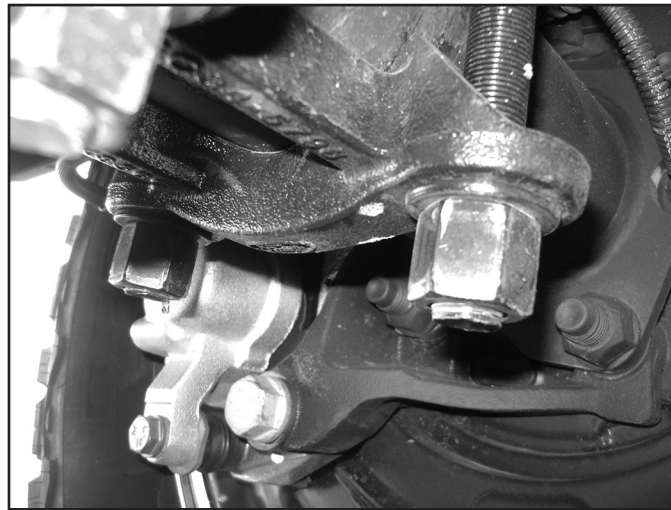

 **Tip** *Ensure all u-bolts have equal thread exposed below the nut.*

56. Repeat block installation of the driver's side. Take care not to over extend the brake lines.
57. If more parking brake cable slack is needed, remove the cable from the rear-most retaining bracket on the frame.

REPLACEMENT LEAF SPRING ONLY

58. Gain slack from the E-Brake cable on the driver's side. It is easiest to pull on the cable and use a pair of vise grips to hold the cable, be careful not to damage the cable.
59. Cut the bracket for the E-brake cable that is going to the passenger side of the vehicle in order to release the cable from the bracket. See Figure 18 for which bracket and where to cut. It is easiest to cut most of the way through the steel and then bend the flange up to release the cable from the bracket. Be careful not to cut the E-brake cable!

FIGURE 18

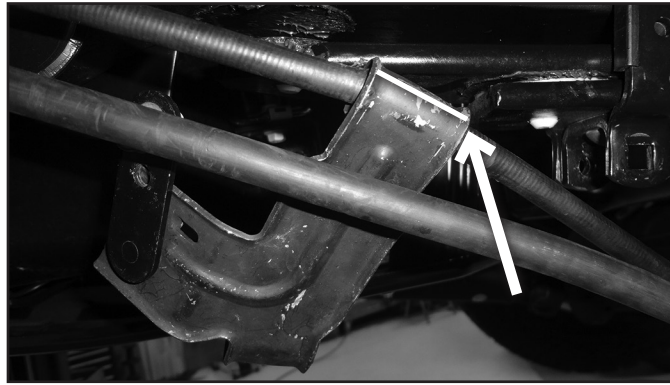

60. Depress the tabs and remove the passenger side E-brake cable from the mount on the frame.
61. Once the passenger side E-brake cable is free, remove the bolt and J-nut attaching the bracket to the frame.
62. Remove the driver side E-brake cable from the bracket and discard the bracket and hardware.
63. Remove the bolt and J-nut for smaller E-brake cable bracket. The E-brake cable relocation bracket will be reinstalled after the new leaf
64. Disconnect the passenger's side u-bolts and lower the axle from the spring.
65. Discard OE block, new leaf springs will install directly to the axle.
66. Loosen and remove the front spring-to-frame and rear shackle-to-frame bolts and remove the spring from the vehicle. *Note: When installing the driver's side leaf spring the fuel tank may have to be shifted towards the passenger's side of the vehicle to remove the front spring-to-frame bolt. Support the fuel tank and loosen the bolts for the fuel tank hanger. Shift the fuel tank towards the passenger's side of the vehicle to remove the leaf spring bolt.*
67. Remove the shackle from the OE spring and loosely install it on the new rear spring. Be sure that the shackle is oriented on the new spring identical to the old. The shackles mount of the longer end of the spring (opposite of the end marked with "FRT").
68. Using a pair of clamps, clamp the top and bottom of the factory leaf next to the OE upper U-bolt mount. Remove the OE upper U-bolt mount from the center pin on the top of the OE leaf spring in order to be installed on the new spring. Reassemble the OE leaf spring with the OE center pin and remove the clamps (Figure 19).

FIGURE 19

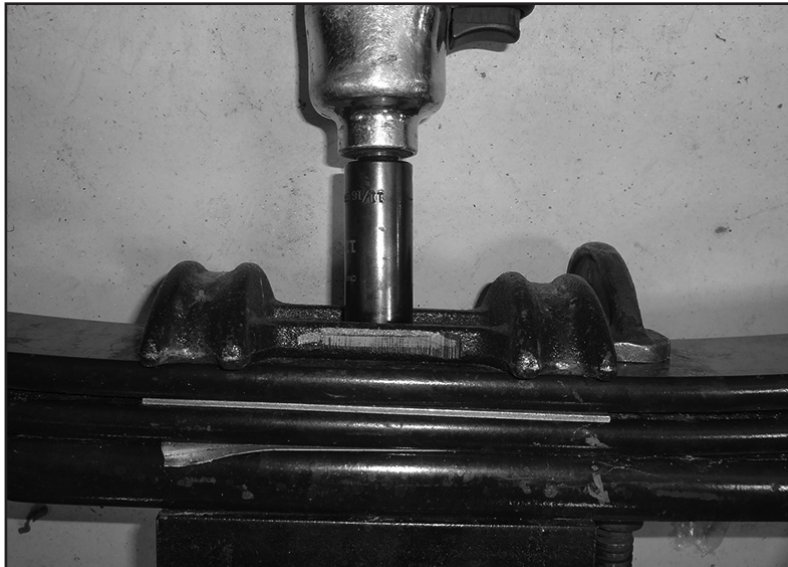

69. The OE upper U-bolt mount will be installed on the new leaf springs. Clamp the top and bottom of the new leaf springs near the center pin, but still allowing enough room to install the OE upper U-bolt mount. Remove the center pin from the new leaf springs and attach the OE upper U-bolt mount to the new leaf springs with the center pin. A pair of new center pins are provided incase the center pins in the new leaf springs strip out.

FIGURE 20



70. Install the new spring in the vehicle with the OE bolts. Use the provided 7/8" SAE Washers as spacers as needed for the front leaf spring bushing (use one on each side of the leaf spring bushing). Leave hardware loose. All of the spring pivot bolts will be torqued with the weight of the vehicle on the springs.
71. Remove all dirt and corrosion from the axle spring pad and raise the axle to the spring while aligning the center pins with the center pin holes. Fasten the spring with the provided u-bolts, 5/8" washers, 5/8" high nut, and OE lower u-bolt plate. Snug but do not torque u-bolts at this time. *Note: The U-bolts may need to be cut shorter for the socket to tighten the nuts*
72. Repeat the procedure on the driver's side. Take care not to over extend the brake lines.

E-BRAKE CABLE RELOCATION PART 2 (REPLACEMENT LEAF SPRINGS ONLY)

73. Install the new E-brake cable bracket with the provided 1/2" hardware and 5/16" hardware from bolt pack 989 as shown in Figure 39. The smaller driver side E-brake cable bracket will be installed in the same position as it was from the factory, but attached with the 5/16" hardware (Figure 21).

FIGURE 21



74. Install the passenger side E-brake cable into the bracket, make sure the tabs on the cable lock the cable into place.

FIGURE 22

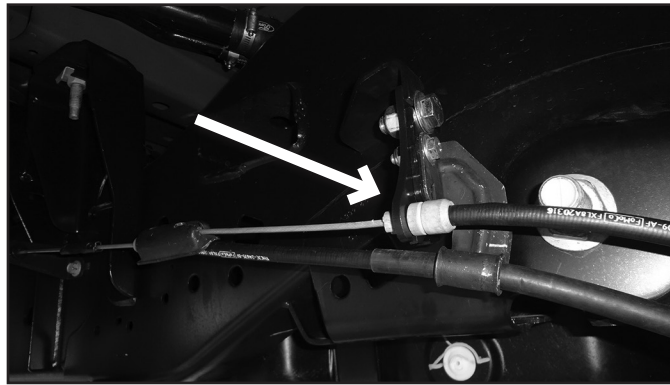

75. Remove the 3/8" bolt on the front leaf springs clamp. Install the E-brake clamp bracket with the new provided 3/8" bolt and nut from bolt pack 998 through the leaf spring clamp. Make sure the E-brake clamp bracket is towards the outside of the leaf spring. Tighten the 3/8" hardware with the spacer tube in between to 25 ft-lbs.

FIGURE 23

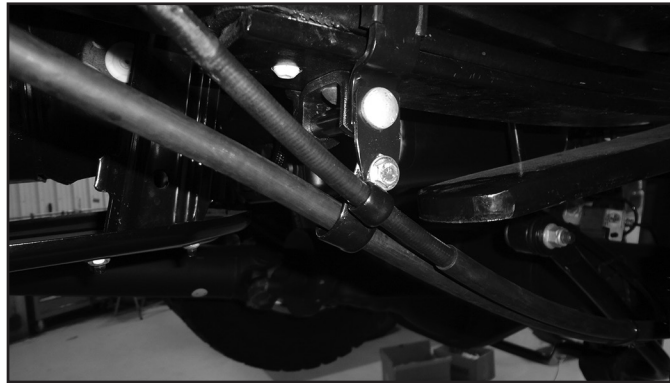

76. Use the two provided wire clips from bolt pack 989 to secure both E-brake cables to the E-brake clamp bracket with the provided 5/16" hardware from bolt pack 989 (Figure 23).

ALL REAR KITS

77. Install the new shocks with the original mounting hardware.
78. Retain ABS wires and vacuum lines with included zip ties. Ensure there is adequate slack at droop and no interference.
79. Install wheels, cycle steering to check for brake line, ABS wire, ETC to tire clearance. With clearance verified lower the vehicle to the ground.
80. With the weight of the vehicle on the axle, torque the u-bolts to 130-150 ft-lbs.
81. Check all hardware for proper torque.
82. Cycle steering to check for brake line, ABS wire, ETC to tire clearance, rotate the driver's side brake line on the hard line if necessary.
83. Adjust steering wheel with adjustment on the drag link, do NOT drive the vehicle with the steering wheel off-center or adverse traction control affects may arise. Rotate the clamps once the steering wheel is straight as shown. (Fig 24A - incorrect, clamps will interfere with sway bar, Fig 24B - correct clearance)
84. An alignment is recommended, but not necessary. BDS recommends running caster at or above the maximum specification for improved handling / driving purposes.
85. Adjust headlights
86. Check hardware after 500 miles.

FIGURE 24A *INCORRECT*



FIGURE 24B *CORRECT*

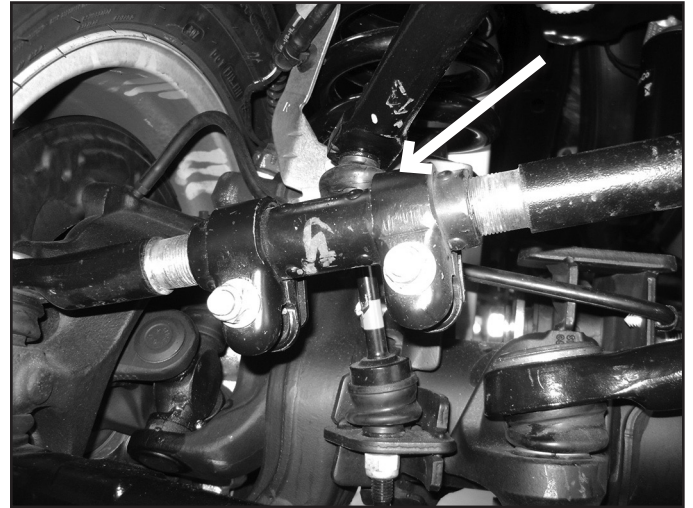

WE WANT TO SEE YOUR RIDE!

Grab photos of your BDS-equipped truck in action and send them in for a chance to be featured. Send it in to our Bad Ass Rides customer gallery at bds-suspension.com/bar and post them on the BDS Fan Page on Facebook at facebook.com/BDSSuspensions. Don't forget about your BDS swag! BDS offers t-shirts, hoodies, decals and more available on the BDS website or through your local BDS distributor.

TIME TO HAVE SOME FUN

Thank you for choosing BDS Suspension.

For questions, technical support and warranty issues relating to this BDS Suspension product, please contact your distributor/installer before contacting BDS Suspension directly.