

INSTALLATION GUIDE

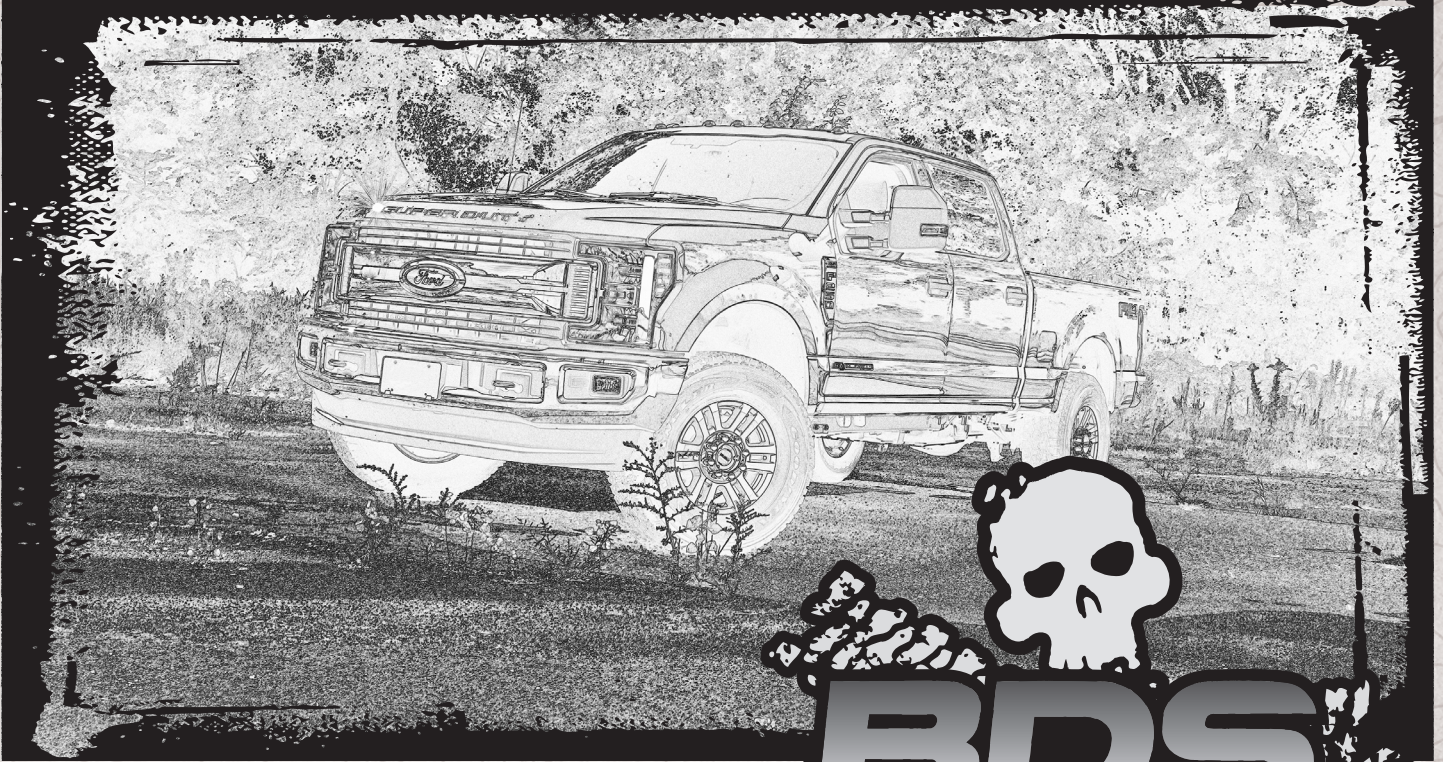

Part#: 013261-013262



HARDCORE LIMITED LIFETIME WARRANTY

Ford Super Duty 2-1/2" Radius Arm Kit

Ford F-250, F350 | 2017-2019

Rev.012920

491 W. Garfield Ave., Coldwater, MI 49036 • Phone: 517-279-2135
Web: www.bds-suspension.com • E-mail: tech-bds@ridefox.com

Read And Understand All Instructions And Warnings Prior To Installation Of System And Operation Of Vehicle.



THANK YOU

Your truck is about to be fitted with the best suspension system on the market today. That means you will be driving the baddest looking truck in the neighborhood, and you'll have the warranty to ensure that it stays that way for years to come. Thank you for choosing BDS Suspension!

BEFORE YOU START

BDS Suspension Co. recommends this system be installed by a professional technician. In addition to these instructions, professional knowledge of disassembly/ reassembly procedures and post installation checks must be known.

FOR YOUR SAFETY

Certain BDS Suspension products are intended to improve off-road performance. Modifying your vehicle for off-road use may result in the vehicle handling differently than a factory equipped vehicle. Extreme care must be used to prevent loss of control or vehicle rollover. Failure to drive your modified vehicle safely may result in serious injury or death. BDS Suspension Co. does not recommend the combined use of suspension lifts, body lifts, or other lifting devices. You should never operate your modified vehicle under the influence of alcohol or drugs. Always drive your modified vehicle at reduced speeds to ensure your ability to control your vehicle under all driving conditions. Always wear your seat belt.

BEFORE INSTALLATION

- Special literature required: OE Service Manual for model/year of vehicle. Refer to manual for proper disassembly/reassembly procedures of OE and related components.
- Adhere to recommendations when replacement fasteners, retainers and keepers are called out in the OE manual.
- Larger rim and tire combinations may increase leverage on suspension, steering, and related components. When selecting combinations larger than OE, consider the additional stress you could be inducing on the OE and related components.
- Post suspension system vehicles may experience drive line vibrations. Angles may require tuning, slider on shaft may require replacement, shafts may need to be lengthened or trued, and U-joints may need to be replaced.
- Secure and properly block vehicle prior to installation of BDS Suspension components. Always wear safety glasses when using power tools.
- If installation is to be performed without a hoist, BDS Suspension Co. recommends rear alterations first.
- Due to payload options and initial ride height variances, the amount of lift is a base figure. Final ride height dimensions may vary in accordance to original vehicle attitude. Always measure the attitude prior to beginning installation.



Visit 560plus.com for more information.

TIRES AND WHEELS

35x12.50x17(18)(20) Tire
4-1/2" ~ 5" Backspace Wheel



BEFORE YOU DRIVE

Check all fasteners for proper torque. Check to ensure for adequate clearance between all rotating, mobile, fixed, and heated members. Verify clearance between exhaust and brake lines, fuel lines, fuel tank, floor boards and wiring harness. Check steering gear for clearance. Test and inspect brake system.

Perform steering sweep to ensure front brake hoses have adequate slack and do not contact any rotating, mobile or heated members. Inspect rear brake hoses at full extension for adequate slack. Failure to perform hose check/ replacement may result in component failure. Longer replacement hoses, if needed can be purchased from a local parts supplier.

Perform head light check and adjustment.

Re-torque all fasteners after 500 miles. Always inspect fasteners and components during routine servicing.

CONTENTS OF YOUR KIT

BDS 033251 - 2.5" Coil Springs

Part #	Qty	Description
033251R	2	Coil Springs

Rear Kit BDS 013407 - 4" Tall Rear Block +3/4" Lift

Part #	Qty	Description
02786	2	4in Superduty Block w/ Wing
583181600SB	4	5/8" x 3-1/8" x 16 Semi-Round U-bolt
B949	1	Bag Kit - 5/8" U-Bolts
N58FHB	8	5/8" Fine High Nut - Black
W58SB	8	5/8" Washer - Black

BDS 013262 - 2.5" Box Kit - Replacement Radius Arm

Part #	Qty	Description
B1254	1	Bag Kit - 2.5" w/ Rad Arm
422	1	Bolt Pack - Sway Bar Drop
03510	2	Brake Line Bracket
696	1	Bolt Pack - Bump Stop & Brake Line
01253	1	Sway Bar Drop - DRV
01254	1	Sway Bar Drop - PASS
A291	1	Front Adjustable Trackbar
B1068	1	Bag Kit - Adjustable Trackbar
3535BK	2	Bushing - black
107	1	1.125 x .156 x 1.745 DOM Tube
516	1	1/4in - 28 Grease Zerk (#60105)
3196	2	3" Dia x 1-1/2" tall bump stop

BDS 123251 - Radius Arm Box Kit

Part #	Qty	Description
A241	1	Superduty Replacement Rad Arm - DRV
02799	1	Superduty Replacement Arm
868190	1	Rad Arm Bushing
97525A430	2	Stainless Rivet
02802	1	Stainless Radius Arm Logo Plate
A242	1	Superduty Replacement Rad Arm - Pass
02799	1	Superduty Replacement Arm
868190	1	Rad Arm Bushing
97525A430	2	Stainless Rivet
02802	1	Stainless Radius Arm Logo Plate
B1114	1	Bag Kit - Replacement Radius Arm
02421	4	Caster Cam Plates
02002ZP	2	M18-2.50 X 150mm Bolt
N18MPT	2	M18-2.50 Prevailing Torque Nut
W34SAE	4	Washer
099002	2	Zip Tie - Push In
099000	6	Zip Tie

TECH TIPS

TROUBLESHOOTING INFORMATION FOR YOUR VEHICLE

1. Larger tires on stock wheels are not recommended due to brakeline clearance required. Use recommended specifications listed in tire and wheel fitment section.
2. Trackbar mounting bolt requires 405 ft-lbs of torque, plan ahead on how to achieve this.
3. Steering on F-250/F-350 trucks can be stiff from the factory. Replacement radius arms with increased caster typically help this issue. The base 2.5" lift with ball joint cams and or steering stabilizer options will not fix this problem. We have had success in reducing the torque specification to 85 ft-lbs for the upper ball joint. Use this as a last resort to cure factory steering issues.
4. Kit works on Gas model trucks. Gas models will achieve 1/2" more lift in the front.

INSTALLATION INSTRUCTIONS

SPECIAL TOOLS

INSTALLATION INSTRUCTIONS

1. Park the vehicle on a clean, flat surface and block the rear wheels for safety.
2. Disconnect the track bar from the frame bracket. Retain OE hardware. It is easiest to disconnect the track bar before the vehicle is lifted in the air. (Fig 1) Remove the track bar from the axle end. This can be done by removing the ball joint nut at the axle. Reinstall the nut a couple of turns to prevent damage to OE track bar joint threads. Use appropriate puller (small pitman arm puller works in most cases) to dislodge the taper from the axle bracket.
3. Remove the stock track bar. If this is used in conjunction with a BDS lift kit with replacement track bar bracket, save the cam plates. Retain all hardware.

General tools, jacks, jack stands.
30mm (1-3/16") Socket
Small Pitman Arm Puller

FIGURE 1

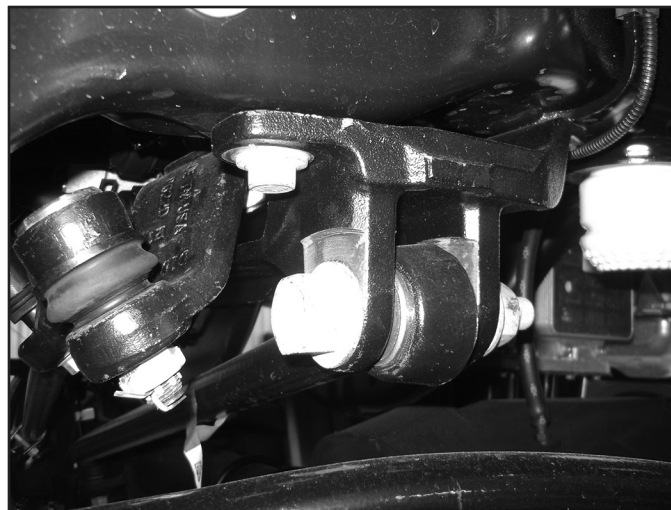

4. Raise the front of the vehicle and support under the frame rails with jack stands.



Tip

As a result of the location of the long radius arm suspension, support locations are limited. Use your best judgment while supporting the vehicle with sufficient strength stands at appropriate locations. The radius arms will need to move freely during this installation.

5. Remove the front wheels.
6. Support the front axle with a hydraulic jack. With the axle supported this installation can be performed on both sides at the same time.

FRONT DISASSEMBLY:

7. Remove the vacuum line from the top of the radius arm on the driver's side (Fig 2a). Remove the vacuum line from the engine crossmember (Fig 2b).

FIGURE 2A



FIGURE 2B

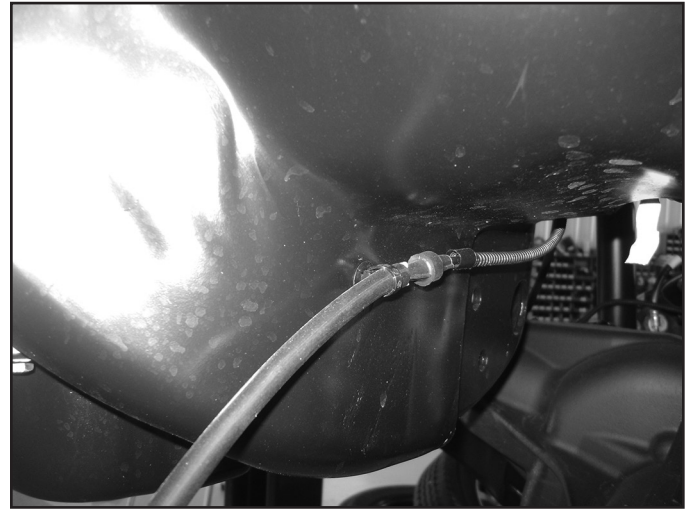

8. Remove the brake line bracket from the lower coil seat. Retain hardware. (Fig 3)

FIGURE 3



9. Disconnect the brake line bracket frame (Fig 4). Retain hardware.

FIGURE 4

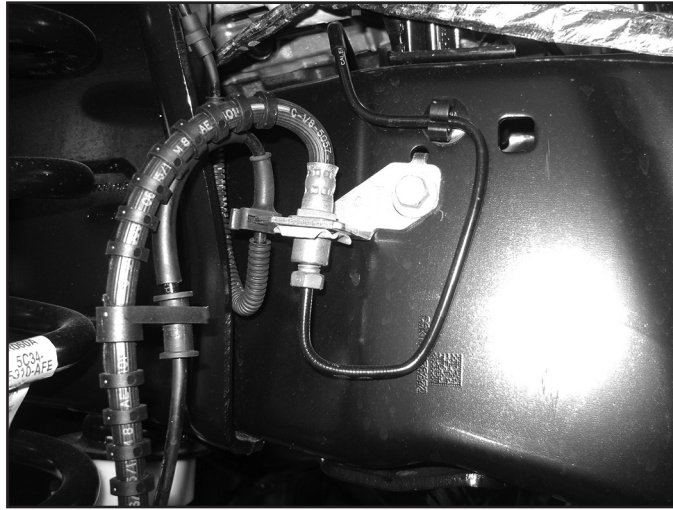

10. Disconnect the shocks by removing factory hardware (Fig 5a, 5b). Retain lower bolt and nut tab for later reinstallation.

FIGURE 5A



FIGURE 5B

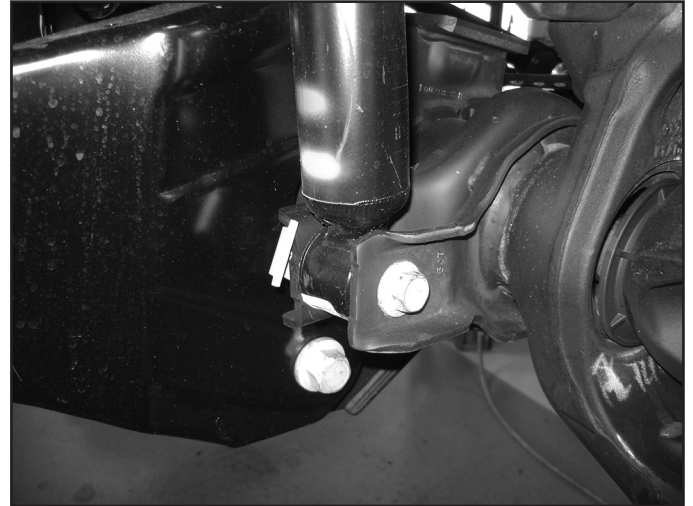

11. Disconnect sway bar from the frame. Retain (4) mounting nuts. (Fig 6)

FIGURE 6



12. Lower the axle and remove the factory coil springs.

13. With coil springs out of the way, remove the factory bump stops, then remove the cup from the frame, discard hardware. (Fig 7a, 7b)

FIGURE 7A

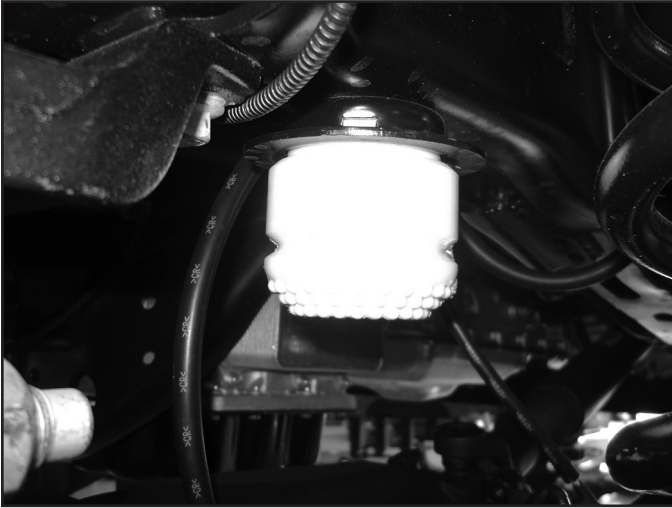

FIGURE 7B



RADIUS ARM INSTALLATION (BDS 013262 ONLY):

14. Working on one side of the vehicle at a time, remove the stock radius arm and replace with the new one. Install cams into the lower slots with new 18m hardware, and use new 18mm nut on the driver's side upper mount at the axle. (Fig 8) The cam will be offset towards the rear of the vehicle as shown in the bottom image of Figure 8.

FIGURE 8

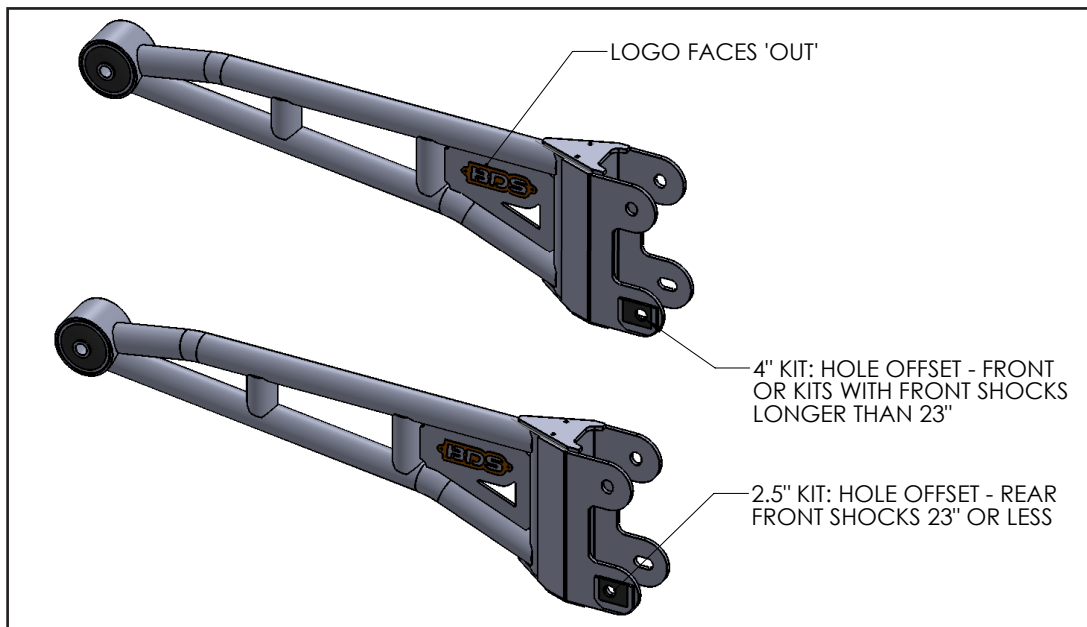

15. Tighten the radius arm hardware at the axle to 222 ft-lbs. Do not tighten the pivot bushing at the frame. (Skip ahead to bump stop installation)

BUMP STOP INSTALLATION

16. Trim off the round edge 1-1/2" from the hole center to have a flat face and coat with paint. This will give extra clearance between the coil spring and cup with the increased wheel travel the kit provides.
17. Install the 1-1/2" bump stop spacer with bump stop cup and 8mm hardware (BP #696). Rotate the bump stop cup so that the newly cut edge is flush with the frame. Note: If installing optional Fox coilovers, the 2" tall bump stop spacer that comes with the coilover mounting brackets will need to be installed. (Fig 9)

FIGURE 9



18. Grease the bump stops and reinstall into the factory cups. Raise the axle to get the bump stops to press into the cups. (Fig 10)

FIGURE 10

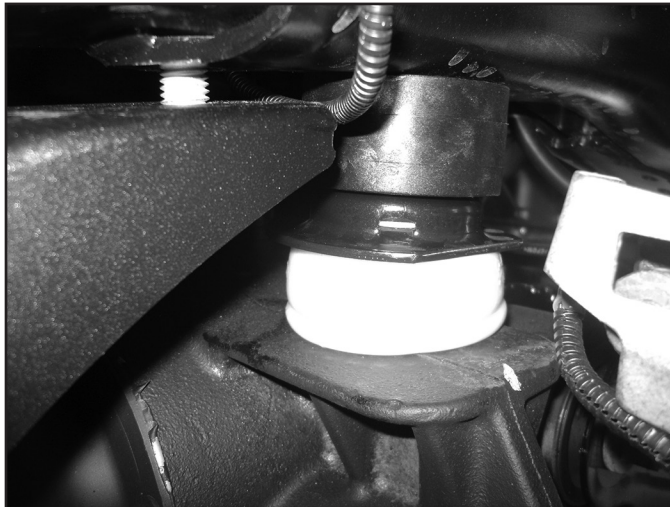

COIL AND SHOCK INSTALLATION

19. If optional coilovers are going to be installed, reference the coilover bracket instruction sheet included with the bracket kit at this time.
20. Grease and install sleeves and bushings into the shocks.
21. BDS (Silver / non-Fox) shocks will require the lower mount to be modified. The sharp, non-formed edge will need to be ground to match the formed profile. Grind this and coat with paint. (Fig 11, 12)

FIGURE 11

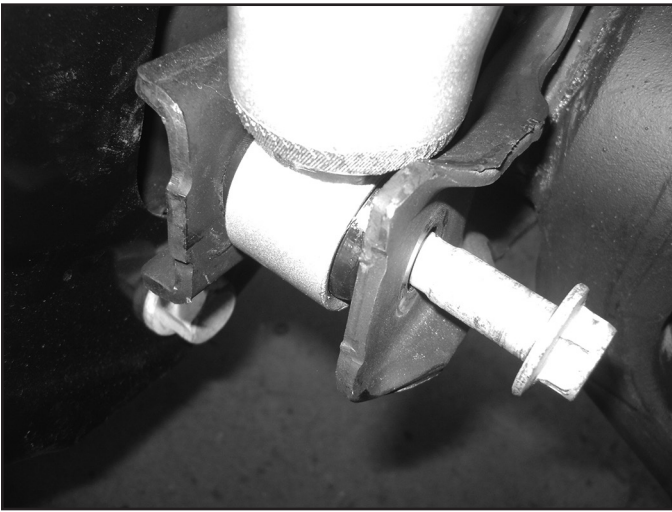
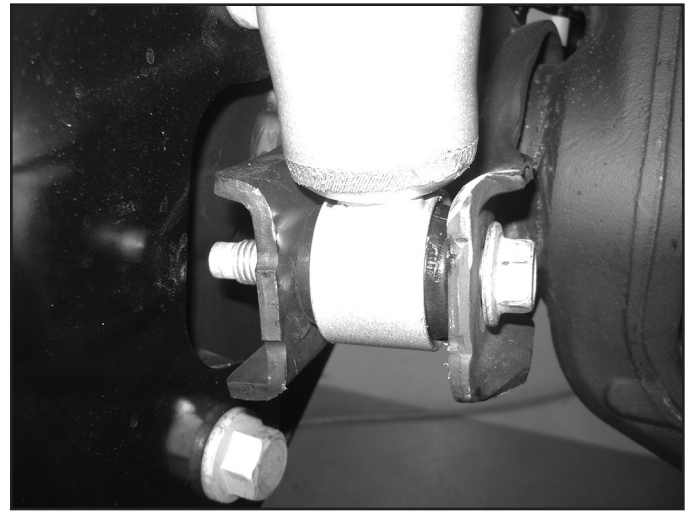

FIGURE 12



22. Compress the coils slightly by using a hydraulic jack on the axle. Install new shocks with factory lower hardware and stem washers, bushings, and 1/2" fine thread nut on the upper mount. Tighten the upper mount until the bushings begin to swell. Tighten lower mount to 50 ft-lbs.
23. Reattach all brake and vacuum lines to the original locations with the OE mounting hardware and included zip ties. Fox coilovers will have the brackets attach to the lower mounting bracket with included hardware.

ADJUSTABLE TRACK BAR BRACKET INSTALLATION

24. Grease and install bushings and sleeves into track bar. Thread grease zerk into track bar. Remove (4) allen bolts and apply loc-tite to threads.
25. Attach the track bar to the axle bracket first. Attach with new 18mm nut. Swing the track bar up to the frame end and check for clearance at the axle end between the new track bar gusset and the axle gussets. It may be necessary to grind the axle gussets for clearance. Once clearance is verified, tighten 18mm ball joint nut to 185 ft-lbs. (Fig 13)

FIGURE 13



BRAKELINE / SWAY BAR BRACKET INSTALLATION

26. Install new brakeline relocation brackets with the factory hardware and 1/4" serrated edge flange nut (BP #696). Tighten all hardware to 15 ft-lbs.. (Fig 14a - Pass Side, 14b - Drv Side).

FIGURE 14A

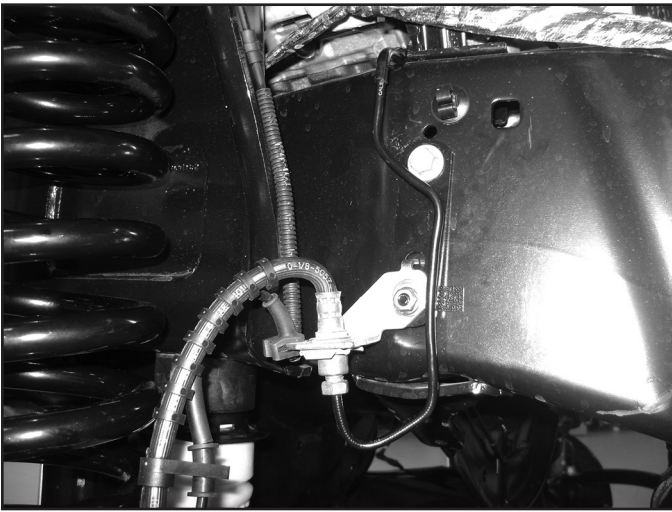
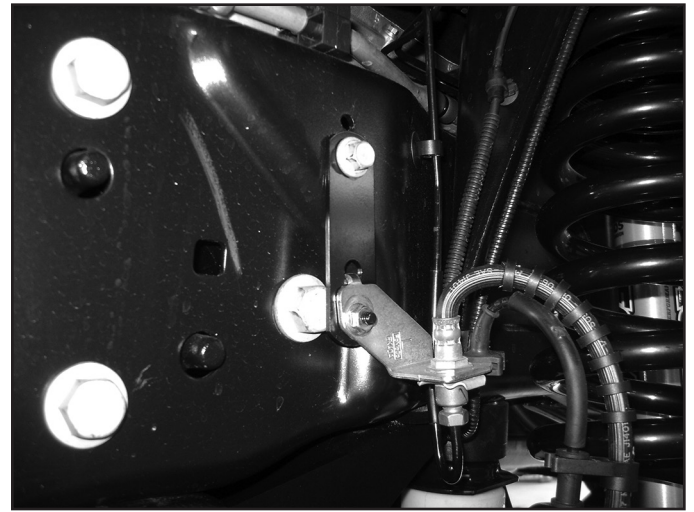

FIGURE 14B



27. Install new sway bar bracket with factory nuts. Slide the brackets as far forward on the vehicle and tighten to 35 ft-lbs.
28. Attach sway bar to the drop bracket with 3/8" hardware (BP #422). Check for sway bar to lower coil mount clearance. Adjust forward / rearward as necessary to have adequate clearance. Tighten to 35 ft-lbs. (Fig 15)

FIGURE 15



29. Reinstal wheels and lower vehicle to the ground.
30. Tighten radius arm pivot hardware at the frame to 222 ft-lbs.
31. Check for sway bar, sway bar link clearance to lower coil mount. Adjust sway bar mounting to bracket if necessary.
32. Attach the track bar to the factory bracket with OE hardware. Have an assistant turn the steering wheel to allow hardware installation. Tighten to 405 ft-lbs.
33. Ensure the axle is square under the vehicle. Additional adjustment of the track bar collar may be required. Check the track bar collar to frame crossmember for adequate clearance. A small amount of grinding on the frame cross member lip may be required for clearance to the track bar under compression clearance. (Fig 16)

FIGURE 16



34. Adjust steering wheel to center, this will require lengthening of the drag link. Do not drive the vehicle with the steering wheel off-center for extended distances / speeds or a trip to the dealership may be required to reset the computer. Note: if there is less than 1-3/4" of thread engaged in the adjusting collar, the track bar must be shortened to allow for adequate thread engagement of the drag link.
35. Adjust the clamps on the drag link so that they will not hit the sway bar through wheel travel or steering range of motion.
36. Check hardware after 500 miles.

REAR INSTALLATION 4" BLOCK KIT

37. Block the front wheels for safety.
38. Raise the rear of the vehicle and support with jack stands under the frame rails just ahead of the spring hangers.
39. Remove the wheels.
40. Support the axle with a hydraulic jack.
41. Remove the factory shocks. Retain all mounting hardware.
42. Disconnect the passenger's side spring u-bolts. (Fig 17)

FIGURE 17



43. Remove the factory lift block. It will not be reused.
44. Lower the axle enough to place the provided 4" lift block between the axle and the leaf spring. Position the block so the bump stop wing faces inward.
45. Raise the axle to engage the block spring alignment pin. (Fig 18) Fasten the entire assembly with the provided u-bolts, high nuts and washers. Snug but do not torque the u-bolts at this time.

FIGURE 18



46. Repeat block installation of the driver's side. Take care not to over extend the brake lines.
47. Install the new shocks with the original mounting hardware. Tighten to 55 ft-lbs.
48. Install wheels and lower the vehicle to the ground.
49. With the weight of the vehicle on the axle, torque the u-bolts to 130-150 ft-lbs. The u-bolts can be trimmed now to the desired length.
50. Torque lug nuts to factory specification.
51. Recheck all hardware for proper torque, check again after 500 miles and at regularly scheduled maintenance intervals.



WE WANT TO SEE YOUR RIDE!

Grab photos of your BDS-equipped truck in action and send them in for a chance to be featured. Send it in to our Bad Ass Rides customer gallery at bds-suspension.com/bar and post them on the BDS Fan Page on Facebook at facebook.com/BDSSuspensions. Don't forget about your BDS swag! BDS offers t-shirts, hoodies, decals and more available on the BDS website or through your local BDS distributor.

TIME TO HAVE SOME FUN

Thank you for choosing BDS Suspension.

For questions, technical support and warranty issues relating to this BDS Suspension product, please contact your distributor/installer before contacting BDS Suspension directly.