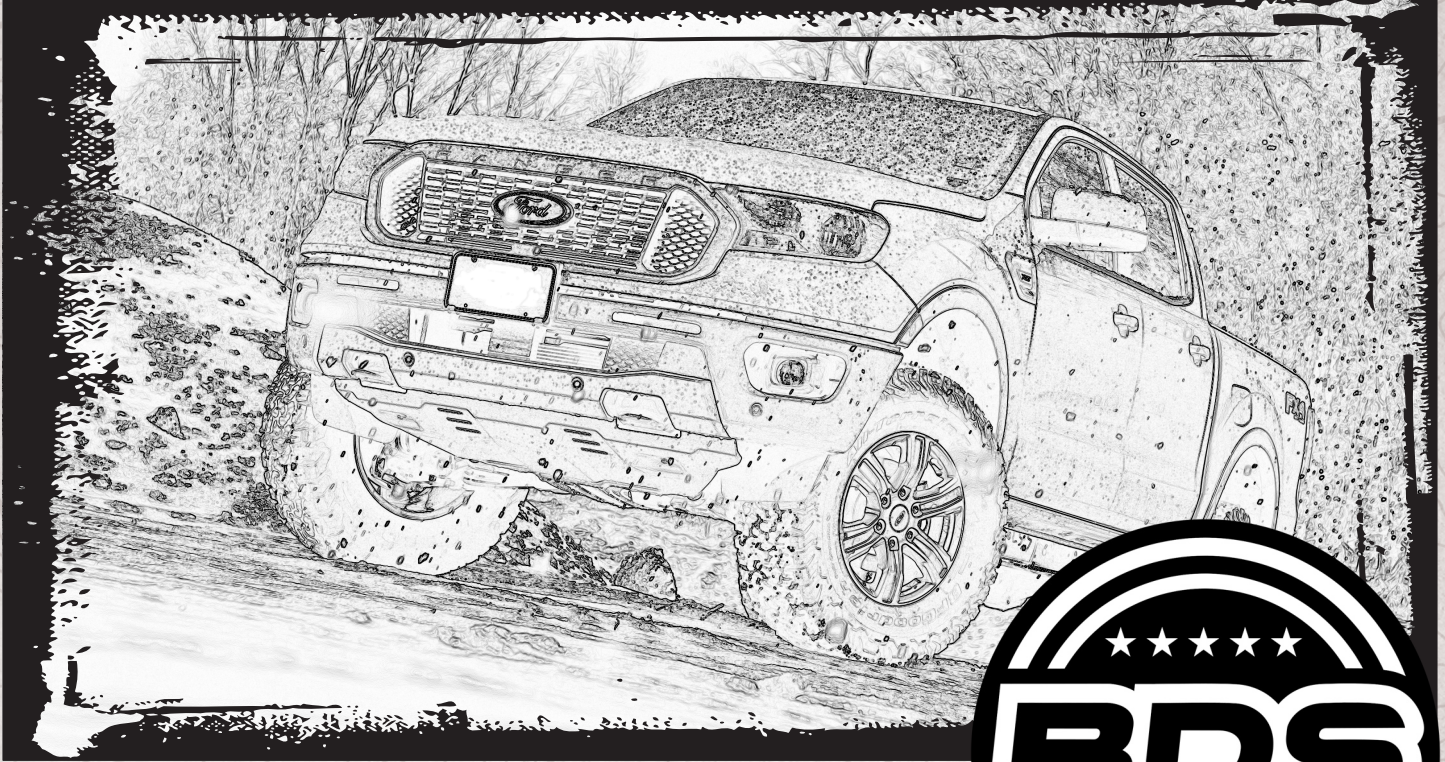


INSTALLATION GUIDE



Part#: 013350



HARDCORE LIMITED LIFETIME WARRANTY

2-3.5" BDS Performance Suspension System

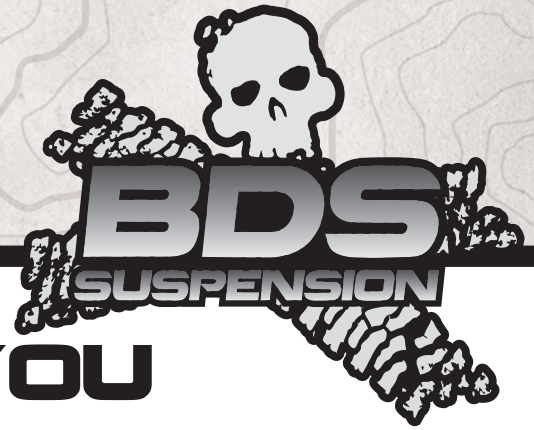
Ford Ranger 4WD / 2WD | 2019

Rev. 052423

491 W. Garfield Ave., Coldwater, MI 49036 • Phone: 517-279-2135

Web: www.bds-suspension.com • E-mail: tech-bds@ridefox.com

Read And Understand All Instructions And Warnings Prior To Installation Of System And Operation Of Vehicle.



THANK YOU

Your truck is about to be fitted with the best suspension system on the market today. That means you will be driving the baddest looking truck in the neighborhood, and you'll have the warranty to ensure that it stays that way for years to come. Thank you for choosing BDS Suspension!

BEFORE YOU START

BDS Suspension Co. recommends this system be installed by a professional technician. In addition to these instructions, professional knowledge of disassembly/ reassembly procedures and post installation checks must be known.

FOR YOUR SAFETY

Certain BDS Suspension products are intended to improve off-road performance. Modifying your vehicle for off-road use may result in the vehicle handling differently than a factory equipped vehicle. Extreme care must be used to prevent loss of control or vehicle rollover. Failure to drive your modified vehicle safely may result in serious injury or death. BDS Suspension Co. does not recommend the combined use of suspension lifts, body lifts, or other lifting devices. You should never operate your modified vehicle under the influence of alcohol or drugs. Always drive your modified vehicle at reduced speeds to ensure your ability to control your vehicle under all driving conditions. Always wear your seat belt.

BEFORE INSTALLATION

Special literature required: OE Service Manual for model/year of vehicle. Refer to manual for proper disassembly/reassembly procedures of OE and related components.

Adhere to recommendations when replacement fasteners, retainers and keepers are called out in the OE manual.

Larger rim and tire combinations may increase leverage on suspension, steering, and related components. When selecting combinations larger than OE, consider the additional stress you could be inducing on the OE and related components.

Post suspension system vehicles may experience drive line vibrations. Angles may require tuning, slider on shaft may require replacement, shafts may need to be lengthened or trued, and U-joints may need to be replaced.

Secure and properly block vehicle prior to installation of BDS Suspension components. Always wear safety glasses when using power tools.

If installation is to be performed without a hoist, BDS Suspension Co. recommends rear alterations first.

Due to payload options and initial ride height variances, the amount of lift is a base figure. Final ride height dimensions may vary in accordance to original vehicle attitude. Always measure the attitude prior to beginning installation.

BEFORE YOU DRIVE

Check all fasteners for proper torque. Check to ensure for adequate clearance between all rotating, mobile, fixed, and heated members. Verify clearance between exhaust and brake lines, fuel lines, fuel tank, floor boards and wiring harness. Check steering gear for clearance. Test and inspect brake system.



Visit 560plus.com for more information.

TRACTION CONTROL

In an effort to reduce the risk of rollover crashes the National Highway Traffic Safety Administration (NHTSA) established the Federal Motor Vehicle Safety Standard (FMVSS) No. 126 requiring all new passenger vehicles under 10,000 lbs GVWR include an electronic stability control (ESC) system as standard equipment. Effective August 2012 this law requires aftermarket products to be compliant with these same standards.



Perform steering sweep to ensure front brake hoses have adequate slack and do not contact any rotating, mobile or heated members. Inspect rear brake hoses at full extension for adequate slack. Failure to perform hose check/ replacement may result in component failure. Longer replacement hoses, if needed can be purchased from a local parts supplier.

Perform head light check and adjustment.

Re-torque all fasteners after 500 miles. Always inspect fasteners and components during routine servicing.

CONTENTS OF YOUR KIT

FOX Shock Parts		
Part #	Qty	Description
FOX98502133	2	2.0 FOX Performance Series Front Coilover
FOX98524207	2	2.0 FOX Performance Series Rear Shock
FOX88302156	1	2.5 FOX Factory Series Front Coilover
FOX88306156	1	2.5 FOX Factory Series Front Coilover - DSC
FOX88323059	1	2.5 FOX Factory Series Rear Piggyback Shock
FOX88326059	1	2.5 FOX Factory Series Rear Piggyback Shock - DSC

BDS013350		
Part #	Qty	Description
A322	1	2019 Ranger UCA - DRV
A323	1	2019 Ranger UCA - PASS
03689	4	Spacer Washers
03779	1	19 Ranger Rear Pass Diff Drop
03780	2	19 Ranger Front Diff Drop
03750	2	19 Ranger Rear Shackle - Inner
03751	2	19 Ranger Rear Shackle - Outer
B1300	1	Bag Kit - Ranger
165	4	0.800 X .150 X 2.70 Machined Sleeve
166	2	0.800 X .150 X 4.20 Machined Sleeve
855	1	Bolt Pack - Shackles
B1299	1	Bag Kit - Ranger
03782	1	19 Ranger Rear Diff Spacer
860	1	Bolt Pack - Diff Drop
B1185	1	Bag Kit - UCA
342701	1	Thread Locker
02911	2	Ball Joint Cap
9452K145	2	O-Ring
45NA53	1	Multi Purpose Grease, Packet, 1cc
967	1	Bolt Pack
03960	2	Upper Strut Mount
03961	2	Lower Strut Mount

BDS013350 - Bolt Packs		
Part #	Qty	Description
855	1	Bolt Pack - Shackles
	2	12mm-1.75 x 150mm Bolt - Clear Zinc - Class 10.9
	4	12mm-1.75 x 110mm Bolt - Clear Zinc - Class 10.9
	12	Washer - Clear Zinc
	6	12mm-1.75 Prevailing Torque Nut - Clear Zinc
881	1	Bolt Pack - Diff Drop
	1	1/2"-13 x 1-1/4" Bolt, Grade 8, Yellow Zinc
	1	1/2"-13 x 1-1/4" BHCS, Black Oxide
	3	1/2" SAE Washer, Yellow Zinc
	2	1/2"-13 Prevailing Torque Nut, Yellow Zinc
	2	7/16"-14 x 4-1/2" Bolt, Grade 8, Yellow Zinc
	4	7/16" SAE Washer, Yellow Zinc
	2	7/16"-14 Prevailing Torque Nut, Yellow Zinc
	1	5/8"-11 x 5" Bolt, Grade 8 Yellow Zinc
	2	5/8" SAE Washer
	1	5/8"-11 Prevailing Torque Nut, Yellow Zinc
	1	5/8" SAE Thru hardened extra thick washer
	2	14mm-1.50 x 55mm Bolt, Class 10.9, Clear Zinc
	2	9/16" SAE Washer, Clear Zinc
967	1	Bolt Pack - UCA
	2	Wire Clip
	2	1/4"-20 x 5/8" bolt grade 5 cz
	2	1/4"-20 serrated edge flanged nut
	2	1/4" SAE Clear Zinc Washer

TIRES AND WHEELS

BS = Back Space, All sizes are up to the listed size, BDS Intrusion Beams Recommended for Max Tire Clearance (BDS123614). A tire wider than listed for each back space will rub on the inner part of the frame. Aggressive sidewall and tire width variation may not allow a 285 tire width to fit on stock wheels without a small wheel spacer. The tire tested on a stock wheel was a 285/70R17 BFG All Terrain.

2.5" Lift with Factory Intrusion Beam:

285/70 R17 with stock BS on stock wheels
285/65 R18 with stock BS on stock wheels

3.5" Lift with Factory Intrusion Beam:

285/70 R17 with stock BS on stock wheels
285/65 R18 with stock BS on stock wheels
275/60 20x9 or 275/65 18x9 with 6.18" BS Wheels
285/55 20x9, or 285/65 18x9, or 285/65 17x9 with 5.5" - 5.75" BS Wheels
305/50 20x9, or 305/60 18x9, or 305/65 17x9 with 5" - 5.75" BS Wheels

2.5" Lift with BDS Intrusion Beam:

275/55 20x9, or 275/65 18x9 with 6.18" BS Wheels
285/50 20x9, or 285/60 18x9, or 285/65 17x9 with 5.5" - 5.75" BS Wheels
305/50 20x9 with 5" BS Wheels

3.5" Lift with BDS Intrusion Beam:

275/65 20x9, or 275/70 18x9 with 6.18" BS Wheels
285/60 20x9, or 285/70 18x9, or 285/75 17x9 with 5.5" - 5.75" BS Wheels
305/55 20x9, or 305/65 18x9, or 33/12.50 20x9, 18x9, 17x9 with 5" BS Wheels



TROUBLESHOOTING INFORMATION FOR YOUR VEHICLE

1. Aftermarket wheels must have a minimum of 93.1mm center bore
2. A taller tire than a 285/70 R17 or 285/65 R18 cannot be installed on factory rims due to clearance to the steering knuckle.
3. Control arms will work with aluminum knuckles only.
4. Special Service Tool 204-592 recommended to dislodge the ball joint.
5. For replacement ball joints, order BDS083202.

INSTALLATION INSTRUCTIONS

PRE-INSTALLATION

1. Park the vehicle on a flat, clean surface and block the rear wheels for safety.

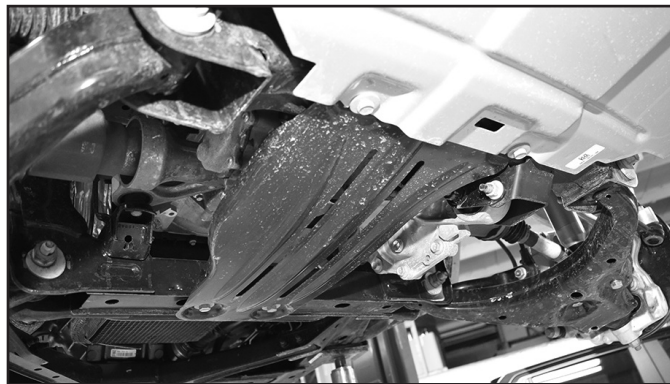
! Caution *Disconnect the power steering control module connector to avoid arching of the contacts in the internal power relay from a hammer blow or impact wrench.*

FRONT INSTALLATION

FRONT DIFFERENTIAL DROP INSTALLATION

2. Raise the front of the vehicle and support with jack stands under the frame rails.
3. Remove the wheels.
4. Remove the differential skid plate (Fig. 1). Retain hardware for later installation.

FIGURE 1



5. Remove the passenger side differential bolt and nut tab (Fig. 2). Save the bolt and discard the nut tab. Support the passenger side of the differential so it is raised up off of the mount.

SPECIAL TOOLS

Basic Hand Tools / Socket and Wrench Set up to 21mm

Jack Stands

35mm Socket

Cut Off Wheel / Reciprocating Saw

Step Drill Bit (Recommended)

Right Angle Drill (Recommended)

Air Hammer (Recommended)

Ball Joint Separation Tool (Recommended; 204-592 Service Tool)

FIGURE 2



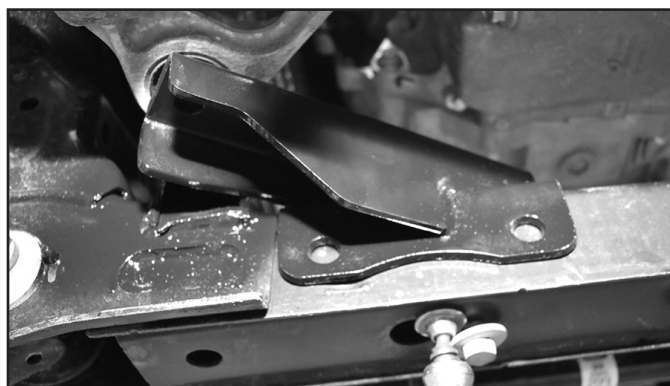
6. Mark a vertical line as close to the rear cross member as possible, but still being able to access with a cut off wheel or sawzall (Fig. 3).

FIGURE 3



7. Cut off the passenger side differential mount as close to the cross member as possible.
8. Install the passenger side differential drop over top of the factory rear cross member, sliding it over to the control arm pocket flange (Fig. 4). The new differential drop must be pushed over so that it is adjacent to the control arm pocket flange. The new differential drop bracket should NOT touch the factory differential mount, clearance out more of the factory differential mount if necessary. Paint any exposed raw metal.

FIGURE 4

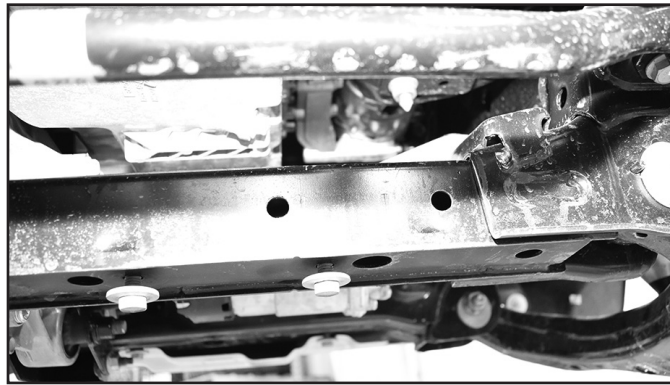


9. Mark the four hole positions to be drilled out on the new differential drop. Drill all 4 holes to 1/2" (Fig. 5). Paint any exposed raw metal.



Tip The differential drop bracket can be left on the cross member and used as a template to drill out the 4 holes.

FIGURE 5



10. Install the two 7/16" bolts, washers, and nuts from bolt pack 860 through the new differential drop and factory rear cross member. Run the bolts from front to rear. Tighten the 7/16" hardware to 40 ft-lbs.
11. Lower the differential and install the factory 10mm bolt through the hole on the new differential mount and the mount on the differential (Fig. 6A). Attach using the factory nut tab on the top of the differential mount. The factory nut tab will need to be cut to leave the wide top mount with nut still attached. Cut along line shown in Figure 6B. Leave hardware loose.

FIGURE 6A



FIGURE 6B



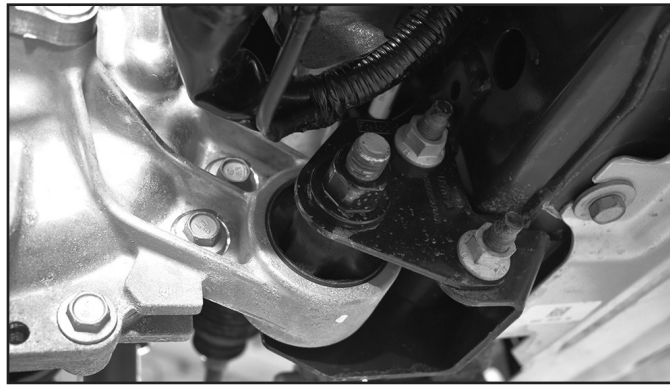
12. Support the differential using a jack. Remove the front 16mm differential bolt (Fig. 7). Discard the bolt.

FIGURE 7



13. Remove the two nuts attaching the plate to the side of the front differential mount (Fig. 8). Save the nuts for later installation. The plate with attached nut can be discarded.

FIGURE 8



14. Remove the two bolts attached to the rear of the differential above the drive shaft. Discard the bolts. Note: Make sure the differential is well supported, it will be free to move after these two bolts are removed.
15. Install the 1/2" spacer between the rear upper differential mount and the differential (Fig. 9A & B). The differential / differential mount has an alignment pin between the two bolts. Apply thread locker and install the provided 14mm bolts and 9/16" washers through the rear upper differential mount, 1/2" spacer, and into the differential. Torque the 14mm bolts to 30 ft-lbs and an additional 70 degrees.

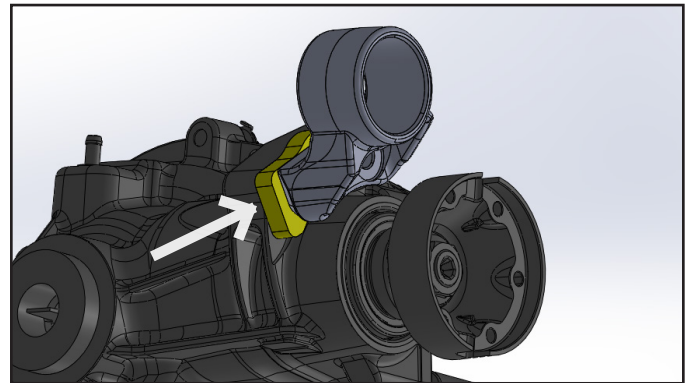


Tip The threads in the differential are very easy to strip out. Make sure the bolt threads into the differential straight to avoid stripping the threads in the differential.

FIGURE 9A



FIGURE 9B



16. Install the front differential mount to the passenger side of the frame using the factory nuts (Fig. 10). Leave the nuts loose.

FIGURE 10



17. Use the provided template at the end of these instructions to drill two holes for the front differential mount on the drive side of the frame (Fig. 11A & B). Cut off the tab using the template along the cut lines.

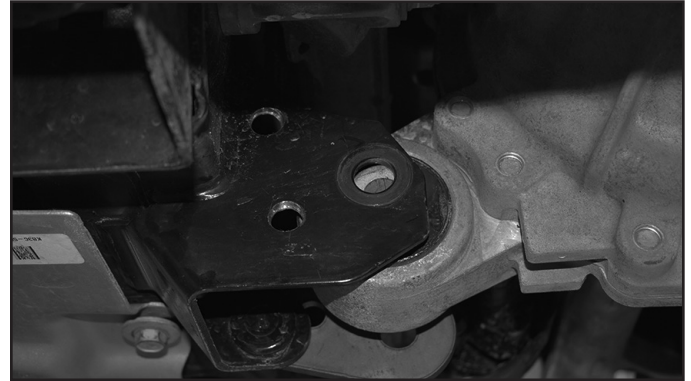


Tip The driver side front cam bolt can be loosened up and slid towards the front of the vehicle to aid in drilling the two holes. A step drill bit and/or a 90 degree drill also aid in drilling the holes. If needed the driver side lower control arm can be removed to provide more room to drill the two holes.

FIGURE 11A

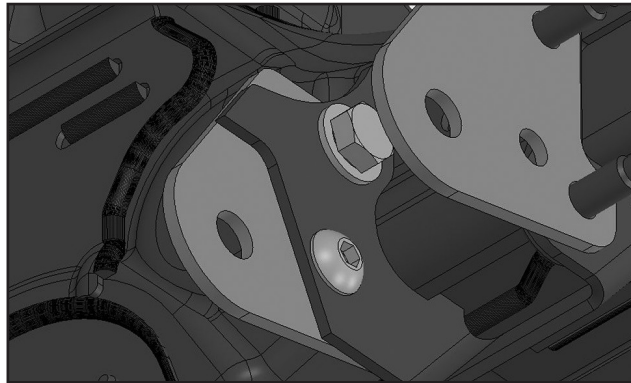


FIGURE 11B (TAB NOT CUT OFF YET)



18. Install the front differential mount to the outside of the driver's side frame mount. Use the provided 1/2" x 1-1/4" hex head bolt for the upper hole and the 1/2" x 1-1/4" Button head cap screw in the lower hole along with the provided washers and nuts (Fig. 12). Leave hardware loose.

FIGURE 12



19. Install the 5/8" bolt, washer, and nut through the new front differential mount and the front mount on the differential. Use the provided 5/8" thick washer on the driver side between the new mount and the differential to take up the thickness of the cut out factory mount (Fig. 13). Leave hardware loose.

FIGURE 13



20. Tighten all 1/2" & 12mm hardware for the front differential mount to 66 ft-lbs. Tighten the 10mm hardware on the passenger side differential mount to 52 ft-lbs. Tighten the 5/8" hardware for the front differential mount to 195 ft-lbs (Fig. 14).

FIGURE 14

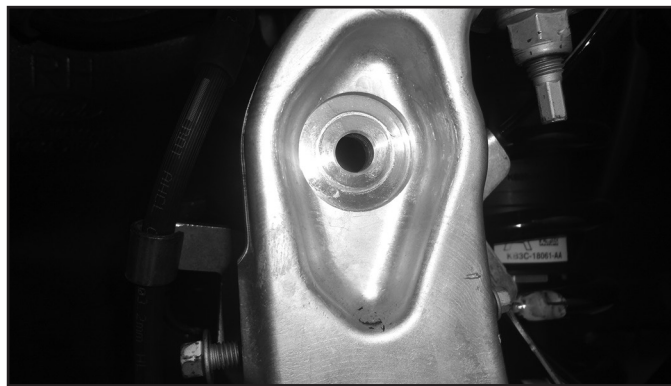


21. Reinstall the differential skid plate using the factory hardware. Torque the bolts to 22 ft-lbs.

FRONT INSTALLATION

22. Disconnect the driver's and passenger's side front sway bar links from the steering knuckle. Save sway bar link nuts. (Fig 15)

FIGURE 15



COMPLETE THIS PORTION OF THE INSTALLATION ON ONE SIDE AT A TIME

23. Disconnect the front brake line from the steering knuckle and the frame (Fig. 16A & B) and ABS line (Fig. 16C) from the steering knuckle. Save bolts.

FIGURE 16A

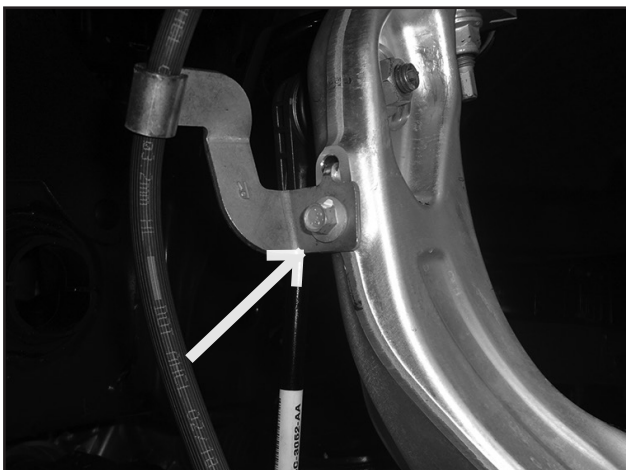
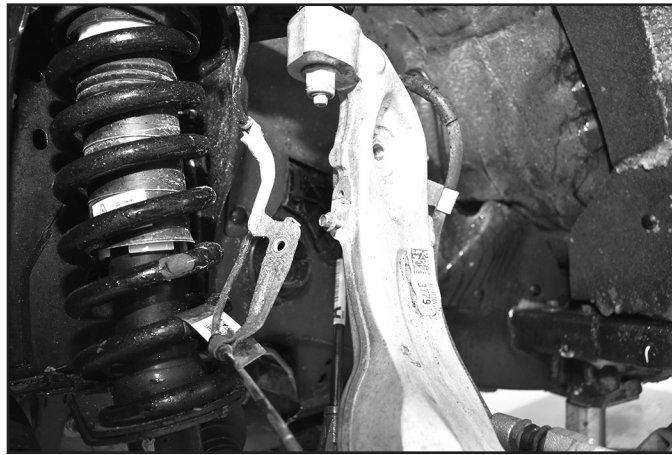


FIGURE 16B

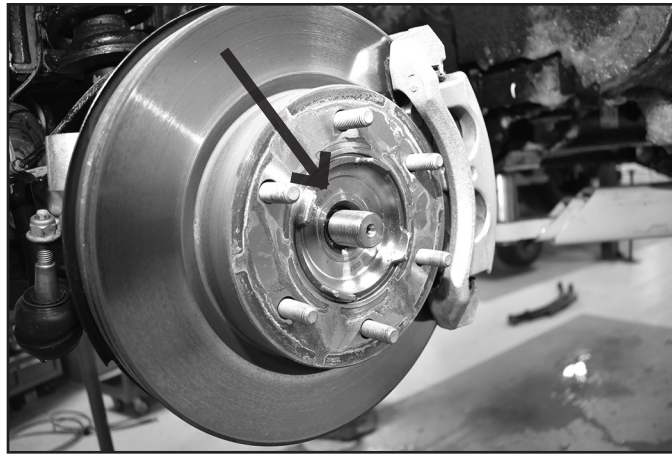


FIGURE 16C



24. Remove the CV retaining nut (Fig. 17). Save nut.

FIGURE 17



25. Remove the steering tie rod end nut from the tie rod end at the steering knuckle. Thread the nut back on a couple of turns by hand. Separate the tie rod end from the knuckle, use of a tie rod end remover is recommended (Fig. 18) Remove the nut and remove the tie rod end from the knuckle. Save nut.

FIGURE 18



26. Remove the upper ball joint nut and thread back on a couple of turns by hand. Separate the upper ball joint from the knuckle, recommended to use Special Service Tool 204-592. (Fig. 19A & B) Remove the nut and remove the ball joint from the knuckle. Allow the knuckle to rest back away from the front strut. Allow the knuckle to rest back away from the front strut.

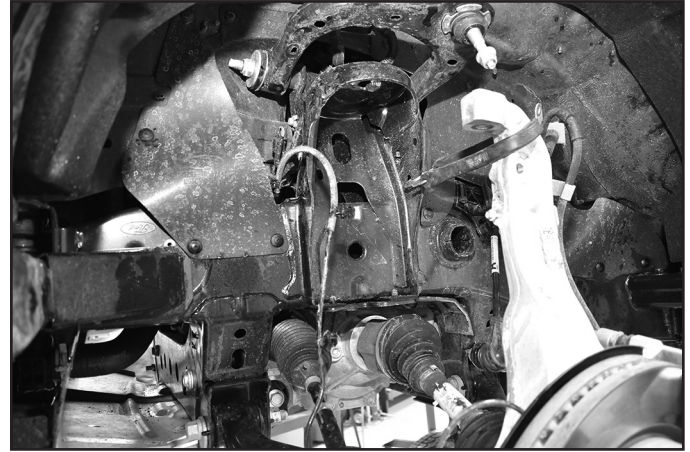


Tip A bungee strap can be used to hold the knuckle from falling forward and pulling the CV shaft out.

FIGURE 19A



FIGURE 19B



UPPER CONTROL ARM INSTALLATION

27. Remove the hardware for the upper arm shield and remove the shield. Save for later installation.
28. Disconnect the ABS wire from the bottom side of the upper control arm (Fig. 20).

FIGURE 20



29. It is recommended to disconnect the ABS wire from the clips on the inside of the fender well / strut mount to prevent over-extending of the ABS wire. Do not allow the brake line to hold the steering knuckle assembly in place.
30. Remove the upper control arm from vehicle. Save the long bolt and nut for use with the new upper control arm. Reference factory service manual if necessary.
31. Install new control arm with factory hardware. Install the provided spacer washers with one on each side of the coil bucket as shown in Figure 21A & B. Snug, but do not torque bolts. Do not connect the upper ball joint to the steering knuckle at this time.

FIGURE 21A

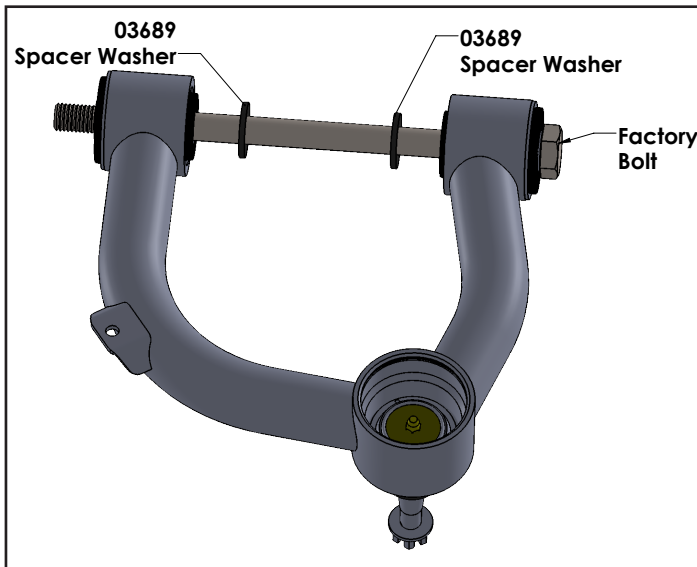
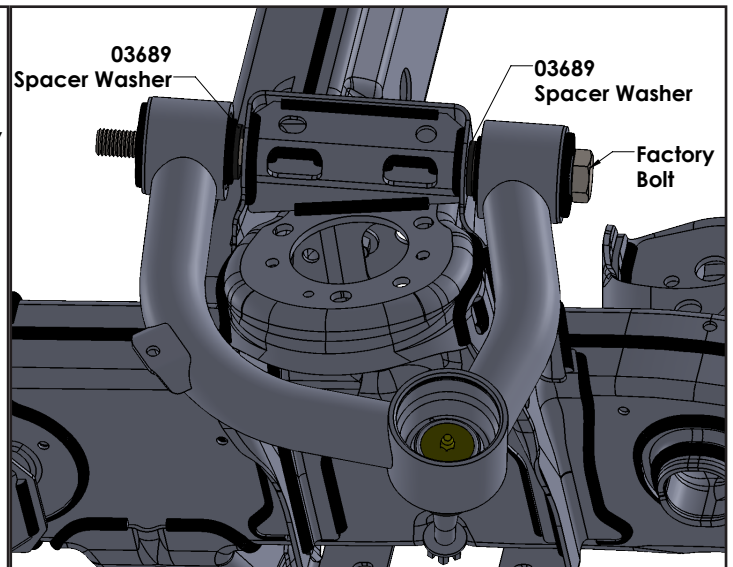


FIGURE 21B



FRONT COILOVER INSTALLATION

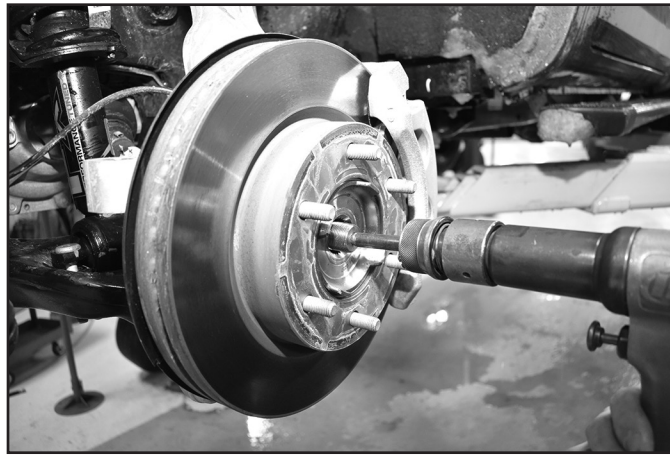
32. Support the lower control arm with an appropriate jack. Remove the three upper strut mounting nuts at the frame (Fig. 22). DO NOT remove the center strut rod nut. Discard the hardware.

FIGURE 22




33. Use an air hammer to dislodge the CV shaft from the hub (Fig. 23). Be careful not to hit the threads on the CV shaft.

FIGURE 23



34. Remove the lower strut mount nuts at the lower control arm (Fig. 24A). Lower the control arm and remove the strut from the vehicle (Fig. 24B). Discard the lower strut hardware. Make sure not to overextend any brake or ABS lines. The ABS sensor may need to be removed from the steering knuckle to gain enough slack.

 **Tip** Leave the lower control arm bolts tight to aid in keeping the knuckle assembly from falling.


 **Tip** If a bungee strap was used to support the knuckle it can be removed now. Slowly lower the lower control arm until the strut is removed being careful not to dislodge the CV shaft from the inner joint. The CV shaft can easily be pulled out from the inner joint.

FIGURE 24A

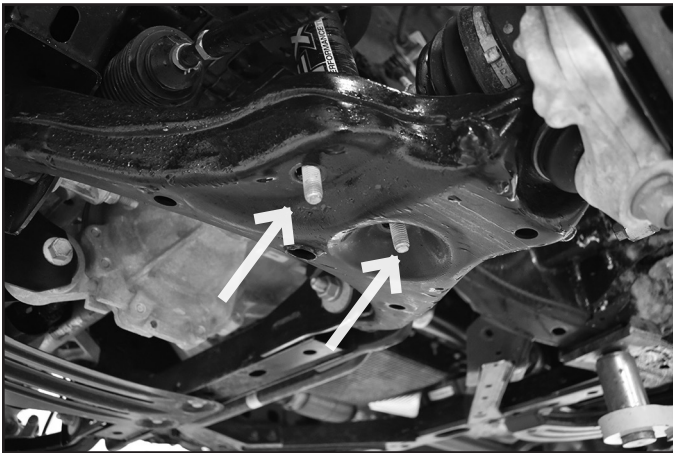
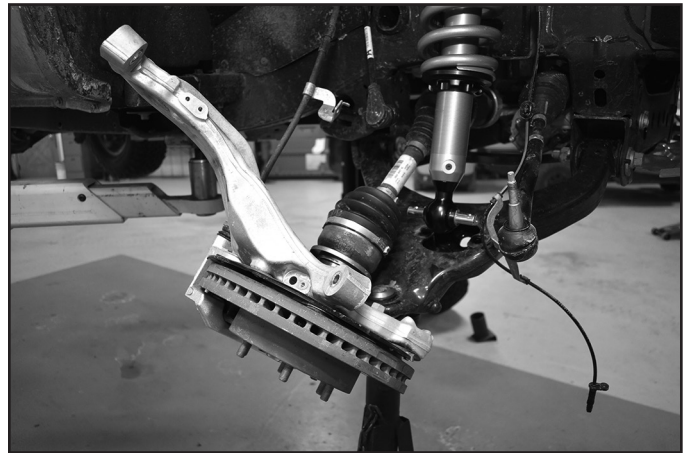


FIGURE 24B



35. Remove the stock strut from the vehicle.
36. If 2"-2.5" of lift is desired on the coilovers, they can be installed with no modification. This will result in approximately 1.5" of rake if the rear shackles are installed (rear shackles provide 1" of lift). If 3-3.5" of lift is desired, use the provide mounts on top of and beneath the coilover. The top mount is shown in Figure 25A and bottom mount in Figure 25B.


 **Tip** If installing this coilover with additional weight from a bumper, winch, etc, an additional 0.4" of preload can be added to the coilover. The MAXIMUM amount of lift should be no more than 3.5" for this kit. DO NOT add preload to produce a taller ride height than 3.5".

FIGURE 25A

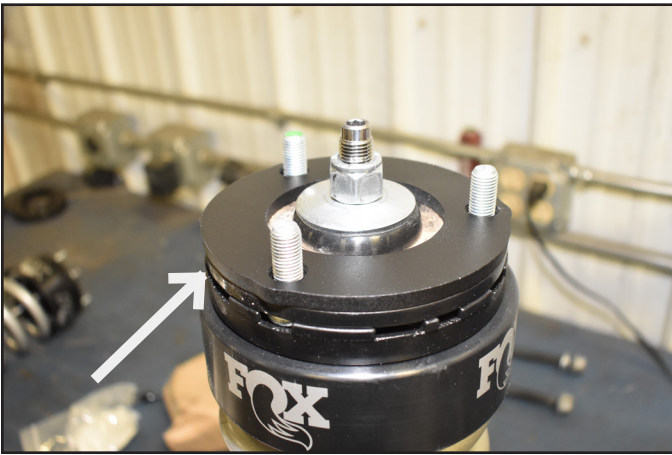


FIGURE 25B



37. Once the stock coil-over is removed, you can now install your new FOX coilover. With remote reservoir models, make sure that the hoses are facing outward and towards the front of the vehicle (Fig. 26). Connect the coilover top hat to the vehicle with the provided washers and nuts. Tighten all three nuts to 24 ft-lbs.


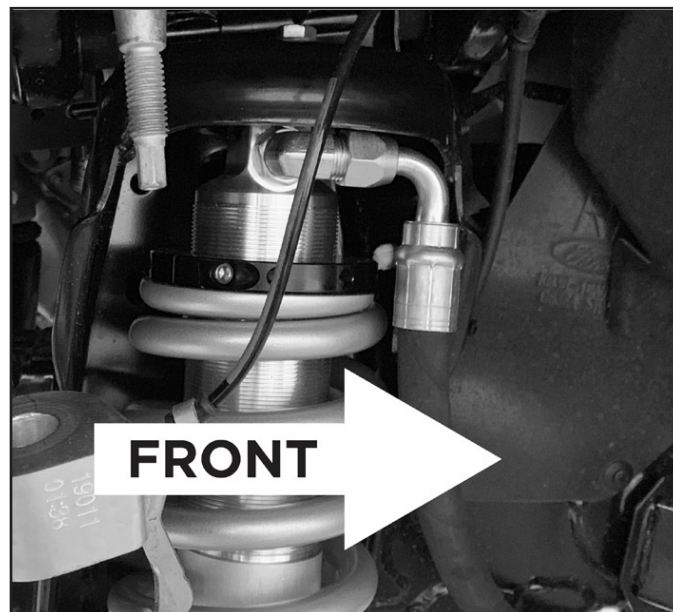
 **Tip** *Be careful again to not dislodge the inner CV joint.*

FIGURE 26



38. Connect the coil-over to the lower control arm using the supplied 12mm bolts and washers. Torque to 50 ft-lbs.
39. With the coilover installed, reconnect the knuckle to the upper ball joint with the provided nut (Fig. 27B). Torque upper ball joint nut to 46 ft-lbs. Install cotter pin. While connecting the upper ball joint, be sure that the CV shaft properly aligns into the hub (Fig. 27A).

FIGURE 27A



FIGURE 27B



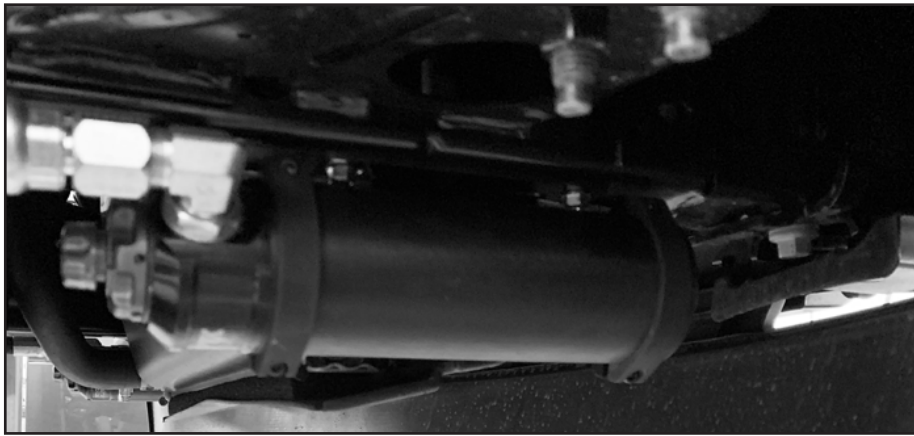
40. GREASE BALL JOINT at this time! Install the O-ring on cap with grease from the included grease packet to aid installation. Install cap. Cap must be removed to access grease fitting for future maintenance.
41. Be sure the CV is properly seated in the hub and reinstall the original retaining nut. Torque nut to 221 ft-lbs.
42. Reconnect the brake line bracket and ABS line to the steering knuckle and frame with the original bolts and nut. Torque hardware to 10 ft-lbs.
43. Attach the steering tie rod end to the steering knuckle with the original nut. Torque to 35 ft-lbs.
44. Remove the factory ABS mounting clips from the ABS line. Attach the ABS wire to the control arm with new 1/4" hardware with new wire clip from Bolt Pack 967. Tighten to 10 ft-lbs (Fig. 28).

FIGURE 28



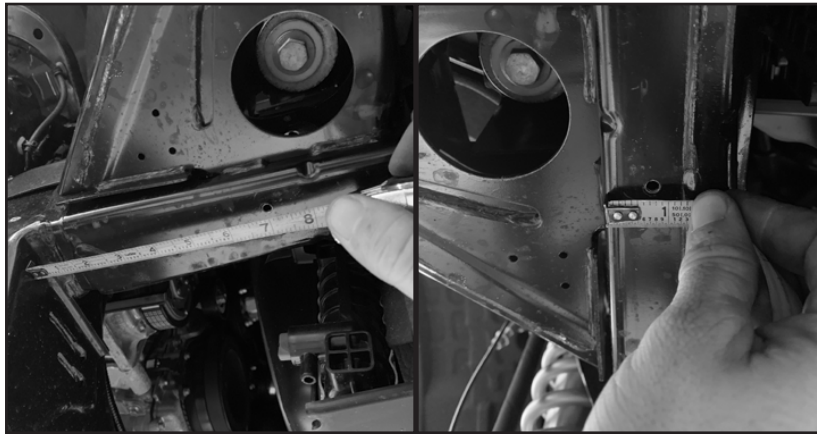
45. On external reservoir models, mount the reservoir onto the reservoir bracket on the bottom of the frame rail, forward the front crossmember. (Fig. 29)

FIGURE 29



46. You will need to mark the first mounting hole 7" from the crossmember and $\frac{3}{4}$ " in towards the engine. (Fig. 30)

FIGURE 30



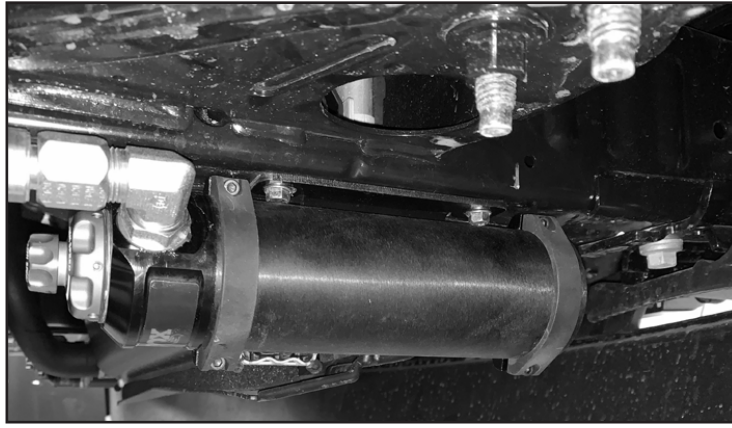
47. Using a $\frac{7}{32}$ " drill bit, drill a pilot hole for the first self-tapping screw. Install one side of the bracket using one of the $\frac{1}{4}$ " self-tapping screws. Once the first screw is installed, drill a $\frac{7}{32}$ " hole using the second bracket hole as a guide. (Fig. 31)

FIGURE 31



48. Now fully install the reservoir bracket onto the vehicle using the supplied $\frac{1}{4}$ " self-tapping screws.
49. Using two supplied billet clamps and screws, mount the reservoir to the brackets. Utilize the slots in the bracket to locate clamps. Do not feed the clamps through the slots in the brackets. (Fig. 32)

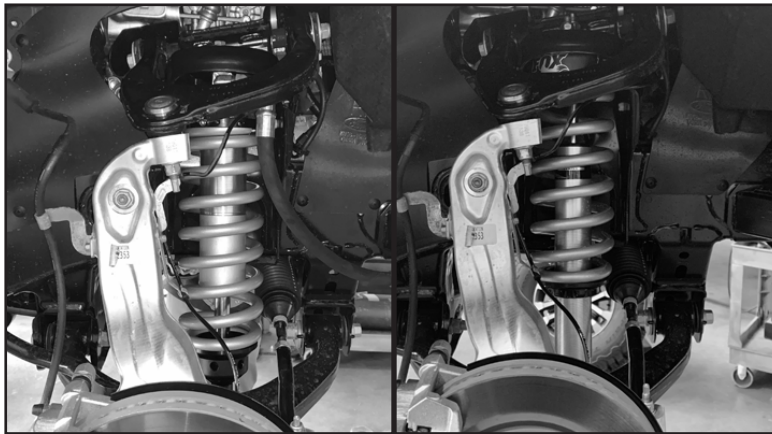
FIGURE 32



50. Installed coil-over will resemble Figure 33.

Driver Side Shown, (Left: 2.5 Factory Race Series Shock, Right: 2.0 Performance Series IFP Shock)

FIGURE 33

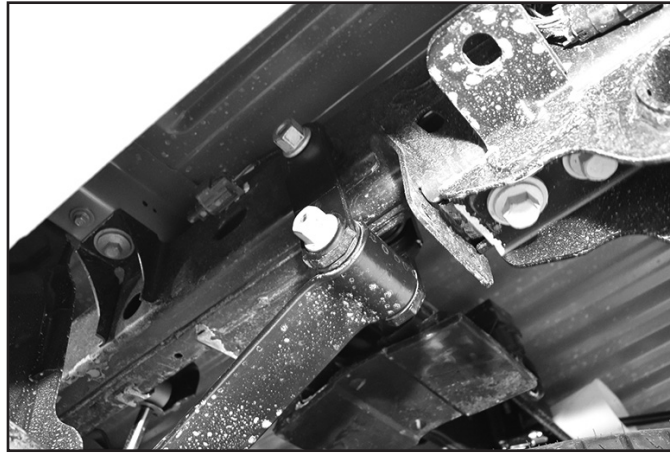


51. Repeat the installation on the opposite side of the vehicle.
52. With both sides complete, reconnect the sway bar links to the sway bar with the original hardware. Torque to 85 ft-lbs.
53. Reinstall the factory front skid with the factory hardware.
54. Install the front wheels and lower the vehicle to the ground. Torque lug nuts to 100 ft-lbs in a crossing pattern.
55. Lower vehicle to the ground. When vehicle is settled at ride height, torque the upper control arm bushing hardware to 122 ft-lbs.
56. Arms give increased caster, a front end alignment is now required.

REAR INSTALLATION

57. Raise the rear of the vehicle and support with jack stands under the frame rails, just ahead of the front leaf spring hangers.
58. Lower the spare tire from under the vehicle enough to allow the rear shackles to be removed.
59. Remove the factory shocks from the axle and frame. Save hardware and discard shocks.
60. Support the rear axle under the differential with a hydraulic jack. Remove the driver's and passenger's rear shackles (Fig. 34). Leave the bushings installed in the leaf springs.

FIGURE 34



61. Grease and install the longer sleeve (166) in the frame end. Grease and install the shorter sleeve (165) in the leaf spring.
62. Install the provided shackle plates on each frame rail using a 12mm x 150mm bolt, nut and washers. The larger offset shackle plate will install on the inside of the frame rail and will offset the same as the factory shackle (Fig. 33A). The smaller offset shackle plate will install on the outside of the frame and offset inwards the same as the factory shackle. Run the bolt from the inside of the frame outward. Leave hardware loose.
63. With both shackles in place, attach the spring eyes to the bottom holes of the shackle plates with a 12mm x 110mm bolt, nut and washers. Run the bolt from the inside out (Fig. 35A). Adjust the position of the spring eyes relative to the shackles by raising or lowering the axle with the jack. Leave hardware loose.
64. Position the additional spacer sleeve (166) between the shackle plates at the center hole and fasten with a 12mm x 150mm bolt, nut and washers (Fig 35B). Run the bolts from the inside out. Leave hardware loose.

FIGURE 35A

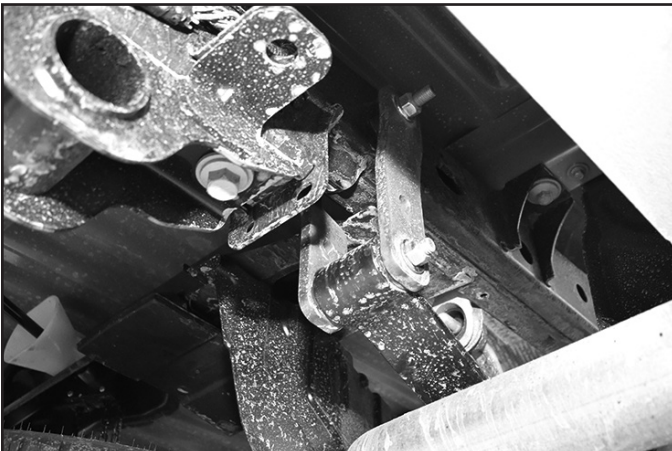
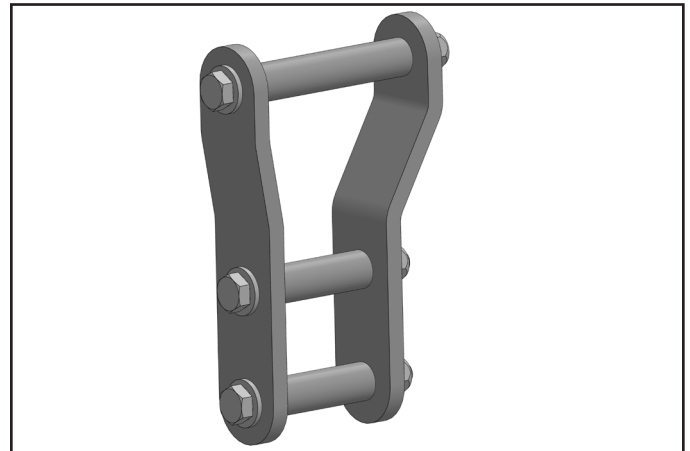
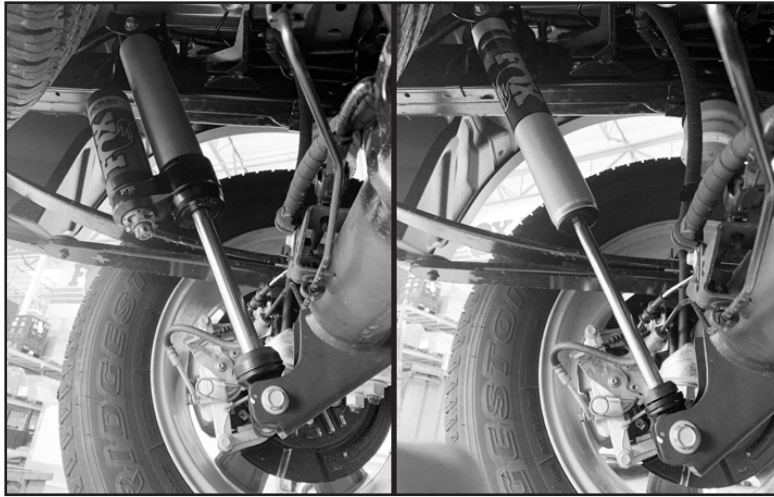


FIGURE 35B



65. Install new FOX shock reusing OEM bolts and nuts. For piggyback reservoir models, make sure reservoir is pointing away from the axle on both driver and passenger sides (Fig. 36). Torque upper and lower bolts to 52 ft-lbs. The axle mounting tabs may need to be bent open slightly to allow for clearance of the larger diameter shocks

FIGURE 36



66. With the shackles loosely assembled, remove the jack stands and lower the vehicle to the ground. Bounce the rear of the vehicle to settle the suspension and torque all 6 shackle bolts to 76 ft-lbs.
67. Raise the spare tire back to its stowed position.

POST INSTALLATION INSTRUCTIONS

68. Check all hardware for proper torque.
69. Check hardware again after 500 miles and at regularly scheduled maintenance intervals.
70. The vehicle will need a complete front end alignment.
71. Adjust headlights.



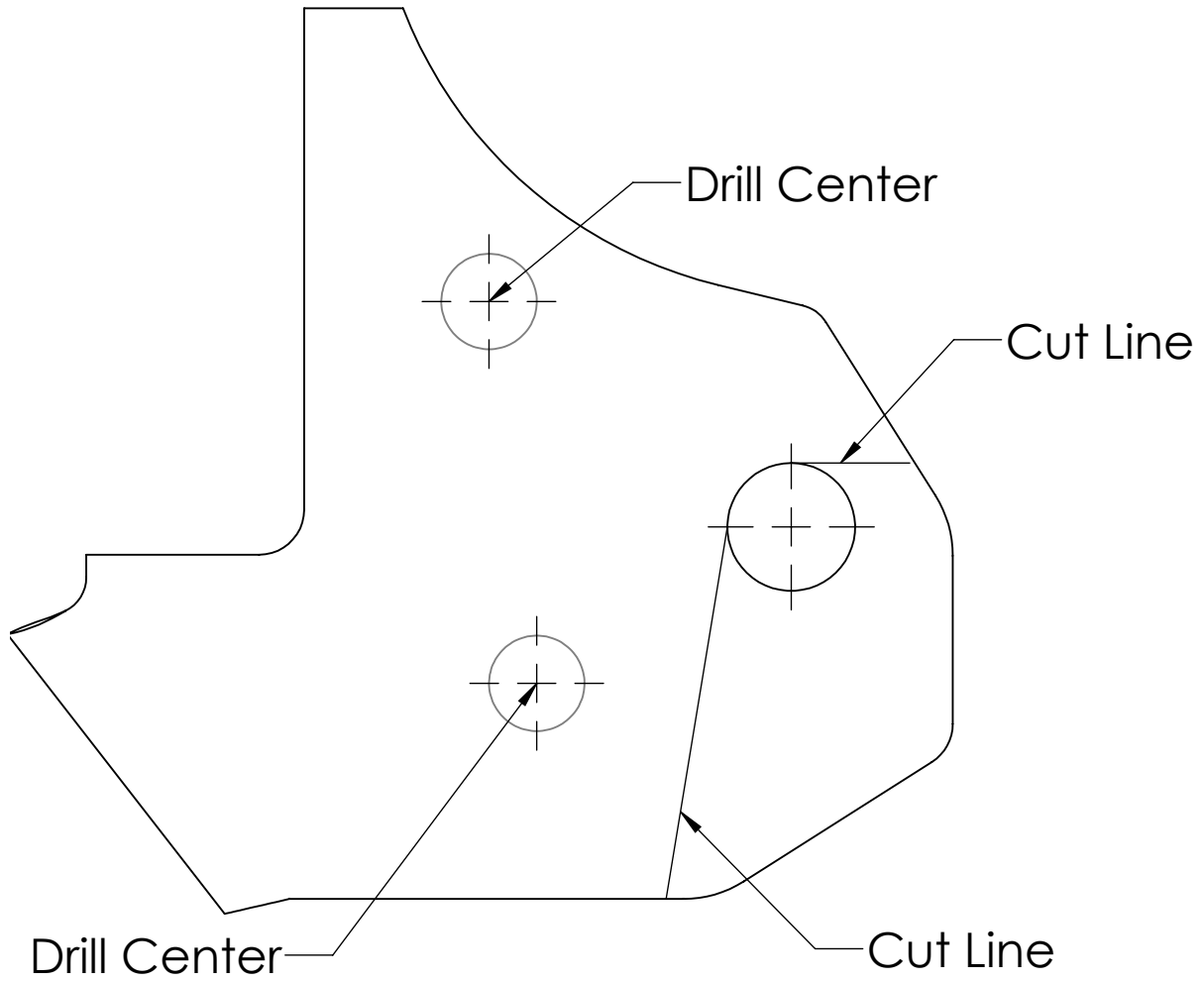
WE WANT TO SEE YOUR RIDE!

Grab photos of your BDS-equipped truck in action and send them in for a chance to be featured. Send it in to our Bad Ass Rides customer gallery at bds-suspension.com/bar and post them on the BDS Fan Page on Facebook at facebook.com/BDSSuspensions. Don't forget about your BDS swag! BDS offers t-shirts, hoodies, decals and more available on the BDS website or through your local BDS distributor.

TIME TO HAVE SOME FUN

Thank you for choosing BDS Suspension.

For questions, technical support and warranty issues relating to this BDS Suspension product, please contact your distributor/installer before contacting BDS Suspension directly.



2019 FORD RANGER 4WD LIFT SYSTEM

TORQUE SPECIFICATIONS

COMPONENT	TORQUE (FT-LBS)
7/16" Differential Drop Hardware	40
14mm Differential Upper DRV Hardware	30 ft-lbs First Pass 70 Deg Second Pass
1/2" and 12mm Differential Front Mount Hardware	66
10mm Differential Pass Side Mount Hardware	52
5/8" Differential Front Mount Hardware	195
Differential Skid Plate	22
Coilover Upper Nuts	24
Coilover Lower Bolts	50
Upper Ball Joint	46
CV Axle Nut	221
Brake Line and ABS Line to Steering Knuckle	10
Tie Rod End to Steering Knuckle	35
ABS Line to Upper Control Arm	10
Sway Bar Link to Steering Knuckle	85
Lug Nuts	100
Upper Control Arm Hardware	122
Rear Shock Bolts (Upper and Lower)	52
Shackle Bolts	76