

INSTALLATION GUIDE

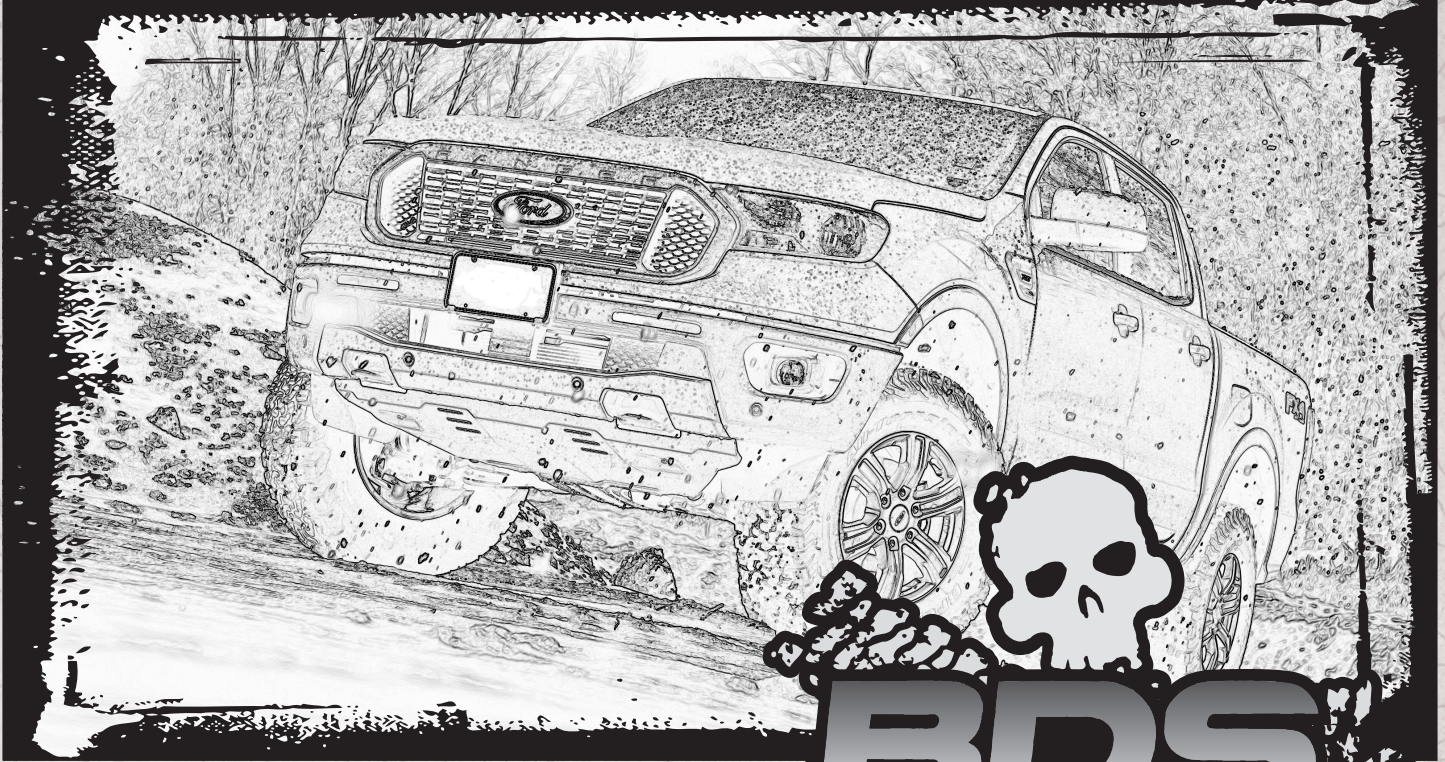

Part#: 013351

HARDCORE LIMITED LIFETIME WARRANTY

3.5" Strut Spacer / Preload Lift

Ford Ranger 4WD | 2019

Rev. 041819

491 W. Garfield Ave., Coldwater, MI 49036 • Phone: 517-279-2135

Web: www.bds-suspension.com • E-mail: tech-bds@ridefox.com

Read And Understand All Instructions And Warnings Prior To Installation Of System And Operation Of Vehicle.

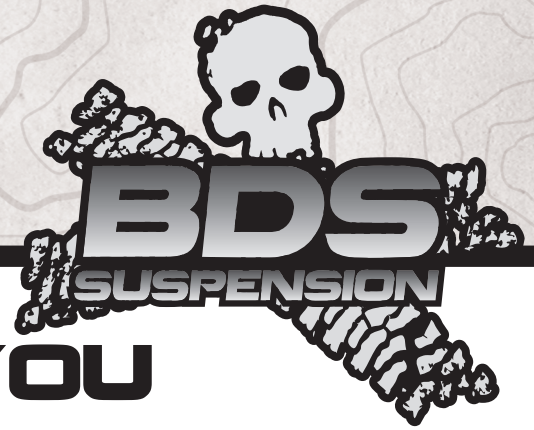

THANK YOU

Your truck is about to be fitted with the best suspension system on the market today. That means you will be driving the baddest looking truck in the neighborhood, and you'll have the warranty to ensure that it stays that way for years to come. Thank you for choosing BDS Suspension!

BEFORE YOU START

BDS Suspension Co. recommends this system be installed by a professional technician. In addition to these instructions, professional knowledge of disassembly/ reassembly procedures and post installation checks must be known.

FOR YOUR SAFETY

Certain BDS Suspension products are intended to improve off-road performance. Modifying your vehicle for off-road use may result in the vehicle handling differently than a factory equipped vehicle. Extreme care must be used to prevent loss of control or vehicle rollover. Failure to drive your modified vehicle safely may result in serious injury or death. BDS Suspension Co. does not recommend the combined use of suspension lifts, body lifts, or other lifting devices. You should never operate your modified vehicle under the influence of alcohol or drugs. Always drive your modified vehicle at reduced speeds to ensure your ability to control your vehicle under all driving conditions. Always wear your seat belt.

BEFORE INSTALLATION

Special literature required: OE Service Manual for model/year of vehicle. Refer to manual for proper disassembly/reassembly procedures of OE and related components.

Adhere to recommendations when replacement fasteners, retainers and keepers are called out in the OE manual.

Larger rim and tire combinations may increase leverage on suspension, steering, and related components. When selecting combinations larger than OE, consider the additional stress you could be inducing on the OE and related components.

Post suspension system vehicles may experience drive line vibrations. Angles may require tuning, slider on shaft may require replacement, shafts may need to be lengthened or trued, and U-joints may need to be replaced.

Secure and properly block vehicle prior to installation of BDS Suspension components. Always wear safety glasses when using power tools.

If installation is to be performed without a hoist, BDS Suspension Co. recommends rear alterations first.

Due to payload options and initial ride height variances, the amount of lift is a base figure. Final ride height dimensions may vary in accordance to original vehicle attitude. Always measure the attitude prior to beginning installation.



Visit 560plus.com for more information.

TRACTION CONTROL

In an effort to reduce the risk of rollover crashes the National Highway Traffic Safety Administration (NHTSA) established the Federal Motor Vehicle Safety Standard (FMVSS) No. 126 requiring all new passenger vehicles under 10,000 lbs GVWR include an electronic stability control (ESC) system as standard equipment. Effective August 2012 this law requires aftermarket products to be compliant with these same standards.



TIRES AND WHEELS

3.5" Lift:

- 285/70 R17 with stock BS on stock wheels
- 285/65 R18 with stock BS on stock wheels
- 275/65 18x9 with 6-1/8" BS
- 285/55 20x9 with 6-1/8" BS



BEFORE YOU DRIVE

Check all fasteners for proper torque. Check to ensure for adequate clearance between all rotating, mobile, fixed, and heated members. Verify clearance between exhaust and brake lines, fuel lines, fuel tank, floor boards and wiring harness. Check steering gear for clearance. Test and inspect brake system.

Perform steering sweep to ensure front brake hoses have adequate slack and do not contact any rotating, mobile or heated members. Inspect rear brake hoses at full extension for adequate slack. Failure to perform hose check/ replacement may result in component failure. Longer replacement hoses, if needed can be purchased from a local parts supplier.

Perform head light check and adjustment.

Re-torque all fasteners after 500 miles. Always inspect fasteners and components during routine servicing.

CONTENTS OF YOUR KIT

BDS013351		
Part #	Qty	Description
A322	1	2019 Ranger UCA - DRV
A323	1	2019 Ranger UCA - PASS
03689	4	Spacer Washers
03781	2	19 Ranger Strut Spacer
03779	1	19 Ranger Rear Pass Diff Drop
03780	2	19 Ranger Front Diff Drop
03750	2	19 Ranger Rear Shackle - Inner
03751	2	19 Ranger Rear Shackle - Outer
B1300	1	Bag Kit - Ranger
165	4	0.800 X .150 X 2.70 Machined Sleeve
166	2	0.800 X .150 X 4.20 Machined Sleeve
855	1	Bolt Pack - Shackles
B1299	1	Bag Kit - Ranger
03644	2	19 Ranger Preload Spacer
03782	1	19 Ranger Rear Diff Spacer
860	1	Bolt Pack - Diff Drop
B1185	1	Bag Kit - UCA
342701	1	Loctite - 1ml (11094-00764)
02911	2	Ball Joint Cap
9452K145	2	O Ring
45NA53	1	Multi Purpose Grease, Packet, 1cc
967	1	Bolt Pack

BDS013351 - Bolt Packs		
Part #	Qty	Description
855	1	Bolt Pack - Shackles
	2	12mm-1.75 x 150mm Bolt - Clear Zinc - Class 10.9
	4	12mm-1.75 x 110mm Bolt - Clear Zinc - Class 10.9
	12	Washer - Clear Zinc
	6	12mm-1.75 Prevailing Torque Nut - Clear Zinc
860	1	Bolt Pack - Diff Drop
	6	10mm-1.50 prevailing torque nut clear zinc
	6	10mm flat washer clear zinc
	1	1/2"-13 x 1-1/4" Bolt, Grade 8, Yellow Zinc
	1	1/2"-13 x 1-1/4" BHCS, Black Oxide
	3	1/2" SAE Washer, Yellow Zinc
	2	1/2"-13 Prevailing Torque Nut, Yellow Zinc
	2	7/16"-14 x 4-1/2" Bolt, Grade 8, Yellow Zinc
	4	7/16" SAE Washer, Yellow Zinc
	2	7/16"-14 Prevailing Torque Nut, Yellow Zinc
	1	5/8"-11 x 5" Bolt, Grade 8 Yellow Zinc
	2	5/8" SAE Washer
	1	5/8"-11 Prevailing Torque Nut, Yellow Zinc
	1	5/8" SAE Thru hardened extra thick washer
	2	14mm-1.50 x 55mm Bolt, Class 10.9, Clear Zinc
2	9/16" SAE Washer, Clear Zinc	
967	1	Bolt Pack - UCA
	2	Wire Clip
	2	1/4"-20 x 5/8" bolt grade 5 cz
	2	1/4"-20 serrated edge flanged nut
	2	1/4" SAE Clear Zinc Washer

TROUBLESHOOTING INFORMATION FOR YOUR VEHICLE

1. A high quality strut compressor is recommended, if one is not available, it is recommended to take the struts to a shop that has one and allow a trained technician to install the preload spacers.
2. Aftermarket wheels must have a minimum of 93.1mm center bore
3. A taller tire than a 285/70 R17 or 286/65 R18 cannot be installed on factory rims due to clearance to the steering knuckle.

**TECH
TIPS**

INSTALLATION INSTRUCTIONS

PRE-INSTALLATION

1. Park the vehicle on a flat, clean surface and block the rear wheels for safety.



Tip

This kit is designed as a two-piece lift system. The combination of a bolt-on strut mount and spring preload ring yields 3.5" of lift. Installation of the preload ring requires disassembly of the struts. This should be done with caution and with the proper tools. If you do not have a proper quality strut compressor tool the struts can be removed from the vehicle and taken to a shop to have the preload ring installed.

SPECIAL TOOLS

Strut Compressor
36mm socket
Step Drill (Recommended)
Sawzall / Cutoff Wheel

! Caution Disconnect the power steering control module connector to avoid arcing of the contacts in the internal power relay from a hammer blow or impact wrench.

FRONT INSTALLATION

FRONT DIFFERENTIAL DROP INSTALLATION

2. Raise the front of the vehicle and support with jack stands under the frame rails.
3. Remove the wheels.
4. Remove the differential skid plate (Fig. 1). Retain hardware for later installation.

FIGURE 1

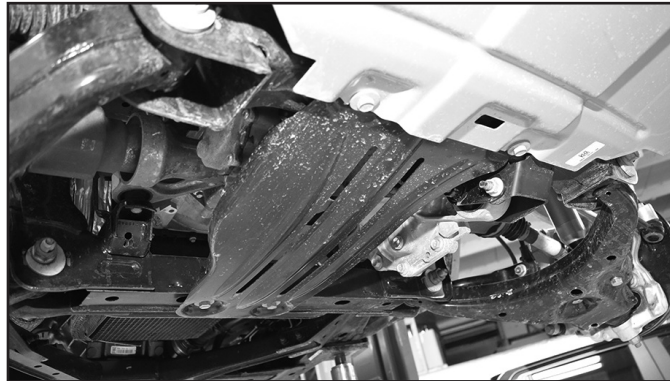

5. Remove the passenger side differential bolt and nut tab (Fig. 2). Save the bolt and discard the nut tab. Support the passenger side of the differential so it is raised up off of the mount.

FIGURE 2



6. Mark a vertical line as close to the rear crossmember as possible, but still being able to access with a cut off wheel or sawzall (Fig. 3).

FIGURE 3



7. Cut off the passenger side differential mount as close to the crossmember as possible.
8. Install the passenger side differential drop over top of the factory rear crossmember, sliding it over to the control arm pocket flange (Fig. 4). The new differential drop must be pushed over so that it is adjacent to the control arm pocket flange. The new differential drop bracket should NOT touch the factory differential mount, clearance out more of the factory differential mount if necessary. Paint any exposed raw metal.

FIGURE 4

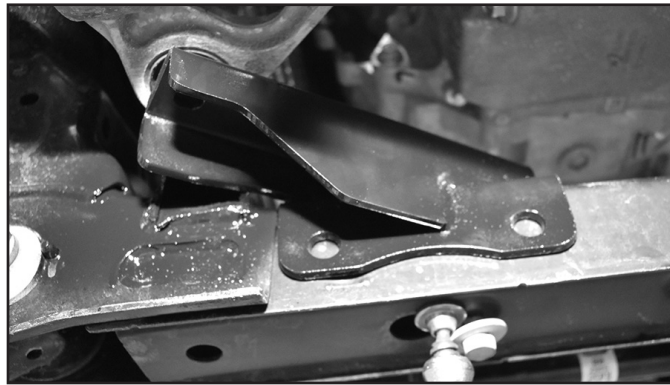

9. Mark the four hole positions to be drilled out on the new differential drop. Drill all 4 holes to 1/2" (Fig. 5). Paint any exposed raw metal.



Tip The differential drop bracket can be left on the crossmember and used as a template to drill out the 4 holes.

FIGURE 5

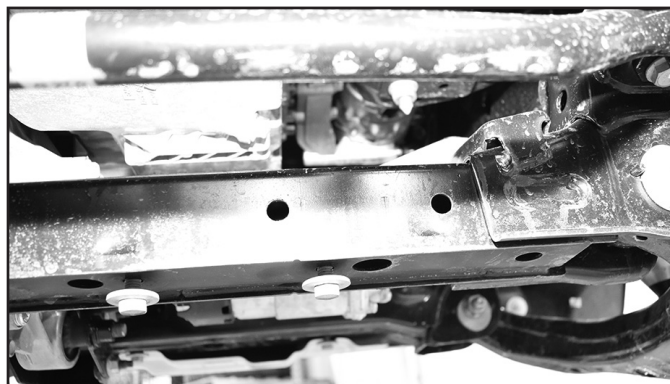

10. Install the two 7/16" bolts, washers, and nuts from bolt pack 860 through the new differential drop and factory rear crossmember. Run the bolts from front to rear. Tighten the 7/16" hardware to 40 ft-lbs.
11. Lower the differential and install the factory 10mm bolt through the hole on the new differential mount and the mount on the differential (Fig. 6A). Attach using the factory nut tab on the top of the differential mount. The factory nut tab will need to be cut to leave the wide top mount with nut still attached. Cut along line shown in Figure 6B. Leave hardware loose.

FIGURE 6A

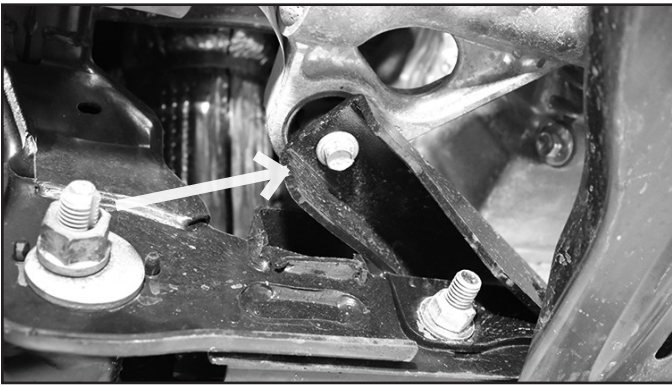
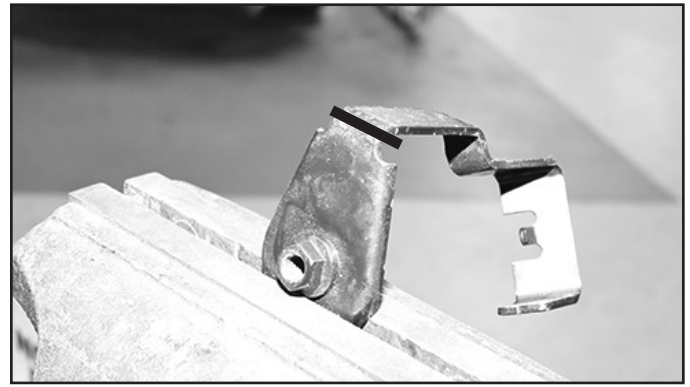

FIGURE 6B



12. Support the differential using a jack. Remove the front 16mm differential bolt (Fig. 7). Discard the bolt.

FIGURE 7



13. Remove the two nuts attaching the plate to the side of the front differential mount (Fig. 8). Save the nuts for later installation. The plate with attached nut can be discarded.

FIGURE 8

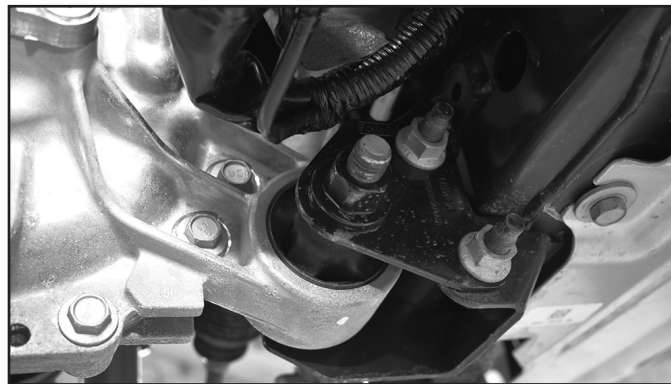

14. Remove the two bolts attached to the rear of the differential above the drive shaft. Discard the bolts. Note: Make sure the differential is well supported, it will be free to move after these two bolts are removed.
15. Install the 1/2" spacer between the rear upper differential mount and the differential (Fig. 9A & B). The differential / differential mount has an alignment pin between the two bolts. Apply Loctite and install the provided 14mm bolts and 9/16" washers through the rear upper differential mount, 1/2" spacer, and into the differential. Torque the 14mm bolts to 80 ft-lbs.



Tip *The threads in the differential are very easy to strip out. Make sure the bolt threads into the differential straight to avoid stripping the threads in the differential.*

FIGURE 9A

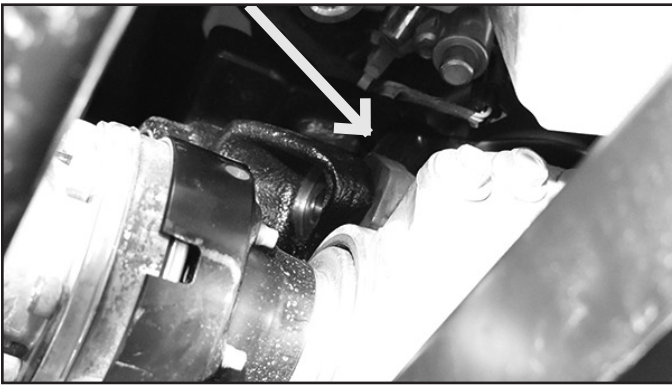
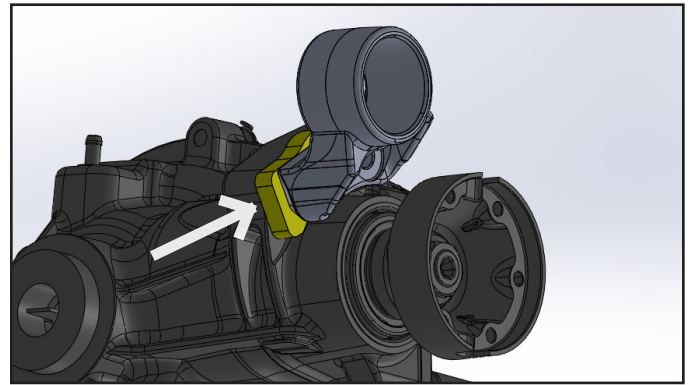
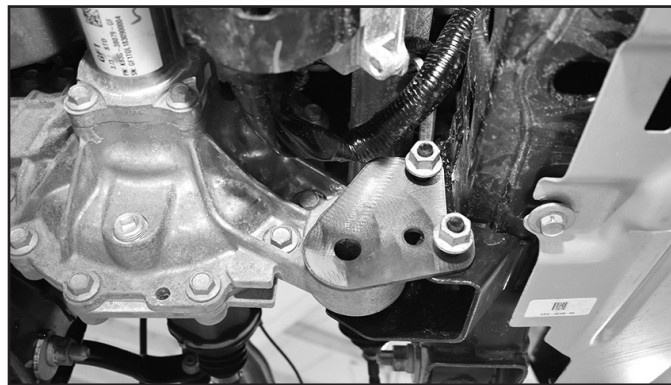

FIGURE 9B



16. Install the front differential mount to the passenger side of the frame using the factory nuts (Fig. 10). Leave the nuts loose.

FIGURE 10



17. Use the provided template at the end of these instructions to drill two holes for the front differential mount on the drive side of the frame (Fig. 11A & B). Cut off the tab using the template along the cut lines.



Tip The driver side front cam bolt can be loosened up and slid towards the front of the vehicle to aid in drilling the two holes. A step drill bit and/or a 90 degree drill also aid in drilling the holes. If needed the driver side lower control arm can be removed to provide more room to drill the two holes.

FIGURE 11A

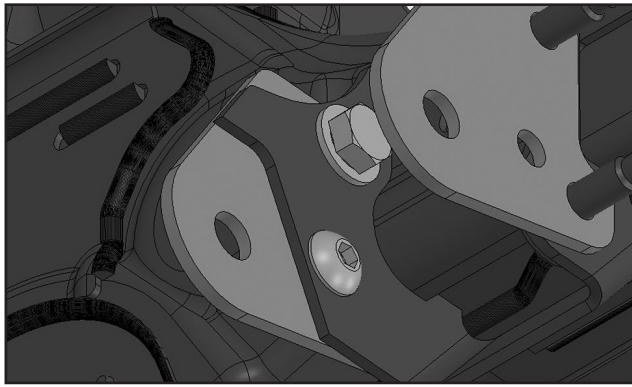

FIGURE 11B (TAB NOT CUT OFF YET)



18. Install the front differential mount to the outside of the driver's side frame mount. Use the provided 1/2" x 1-1/4" hex head bolt for the upper hole and the 1/2" x 1-1/4" Button head cap screw in the lower hole along with the provided washers and nuts (Fig. 12). Leave hardware loose.

FIGURE 12



19. Install the 5/8" bolt, washer, and nut through the new front differential mount and the front mount on the differential. Use the provided 5/8" thick washer on the driver side between the new mount and the differential to take up the thickness of the cut out factory mount (Fig. 13). Leave hardware loose.

FIGURE 13

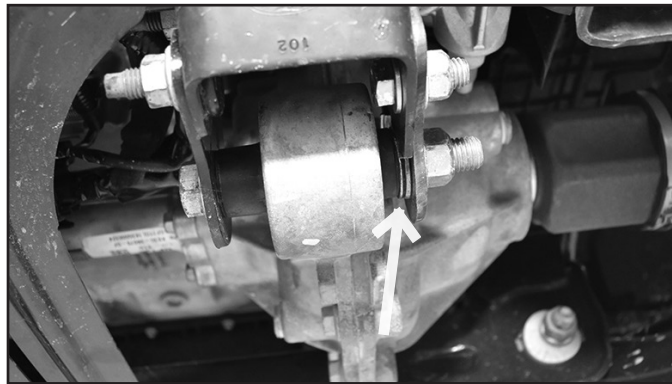

20. Tighten all 1/2" & 12mm hardware for the front differential mount to 65 ft-lbs. Tighten the 10mm hardware on the passenger side differential mount to 40 ft-lbs. Tighten the 5/8" hardware for the front differential mount to 120 ft-lbs (Fig. 14).

FIGURE 14



21. Reinstall the differential skid plate using the factory hardware.

FRONT INSTALLATION

22. Disconnect the driver's and passenger's side front sway bar links from the steering knuckle. Save sway bar link nuts. (Fig 15)

FIGURE 15

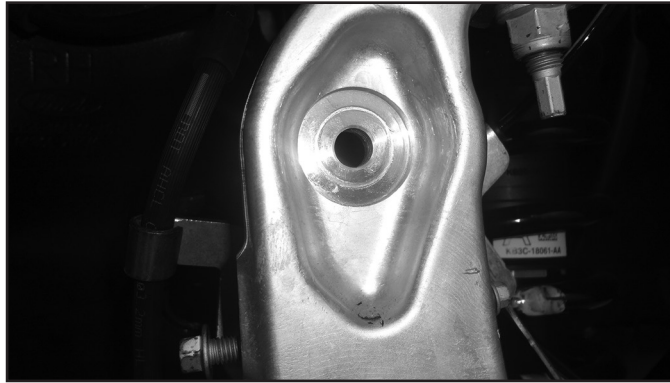

COMPLETE THIS PORTION OF THE INSTALLATION ON ONE SIDE AT A TIME

23. Disconnect the front brake line from the steering knuckle and the frame (Fig. 16A & B) and ABS line (Fig. 16C) from the steering knuckle. Save bolts.

FIGURE 16A

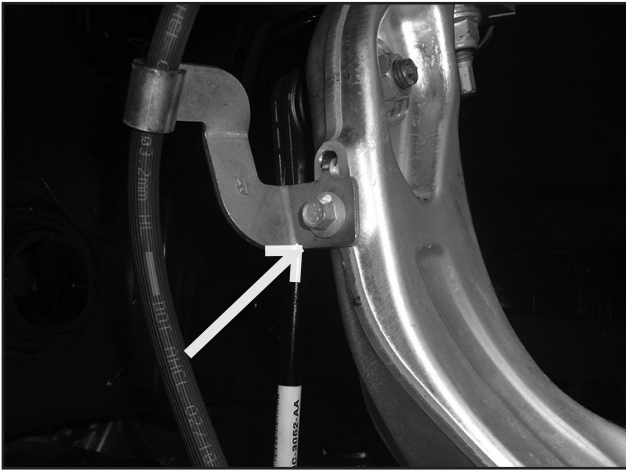
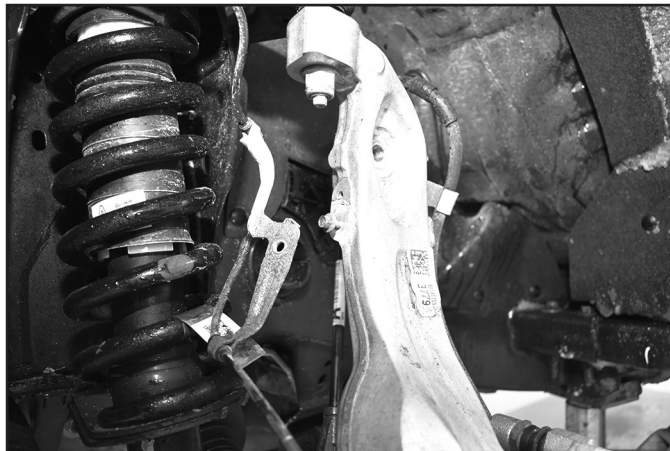

FIGURE 16B



FIGURE 16C



24. Remove the CV retaining nut (Fig. 17). Save nut.

FIGURE 17



25. Remove the steering tie rod end nut from the tie rod end at the steering knuckle. Thread the nut back on a couple of turns by hand. Strike the knuckle near the tie rod end to dislodge it from the knuckle. (Fig. 18) Remove the nut and remove the tie rod end from the knuckle. Save nut.

FIGURE 18



26. Remove the upper ball joint nut and thread back on a couple of turns by hand. Strike the knuckle near the ball joint to dislodge it from the knuckle. (Fig. 19) Remove the nut and remove the ball joint from the knuckle. Save nut. Allow the knuckle to rest back away from the front strut.



Tip A bungee strap can be used to hold the knuckle from falling forward and pulling the CV shaft out.

FIGURE 19A



FIGURE 19B

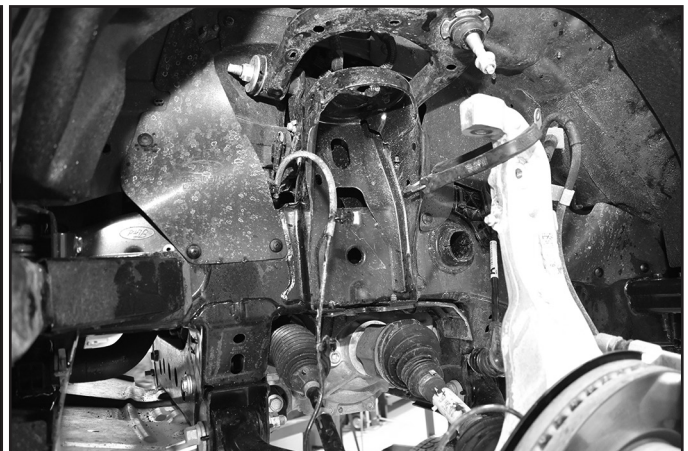

UPPER CONTROL ARM INSTALLATION

27. Disconnect the ABS wire from the bottom side of the upper control arm.
28. It is recommended to disconnect the ABS wire from the clips on the inside of the fender well / strut mount to prevent over-extending of the ABS wire. Do not allow the brake line to hold the steering knuckle assembly in place.
29. Remove the upper control arm from vehicle. Save the long bolt and nut for use with the new upper control arm. Reference factory service manual if necessary.
30. Install new control arm with factory hardware. Install the provided spacer washers with one on each side of the coil bucket as shown in Figure 20A & B. Snug, but do not torque bolts. Do not connect the upper ball joint to the steering knuckle at this time.

FIGURE 20A

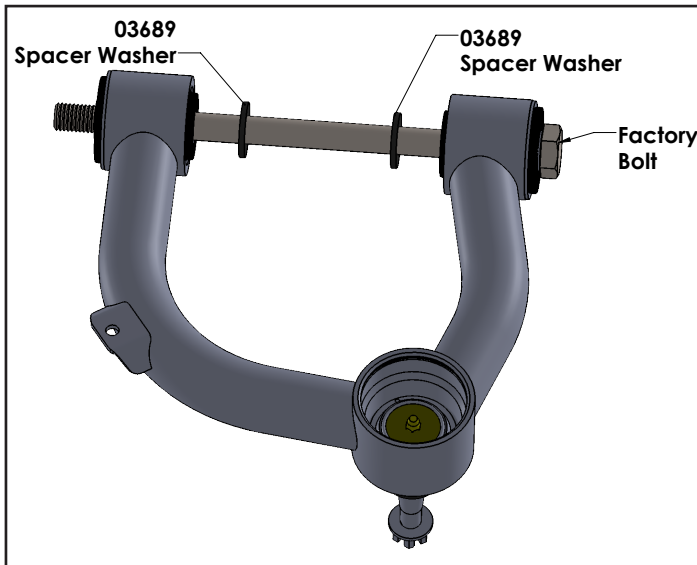
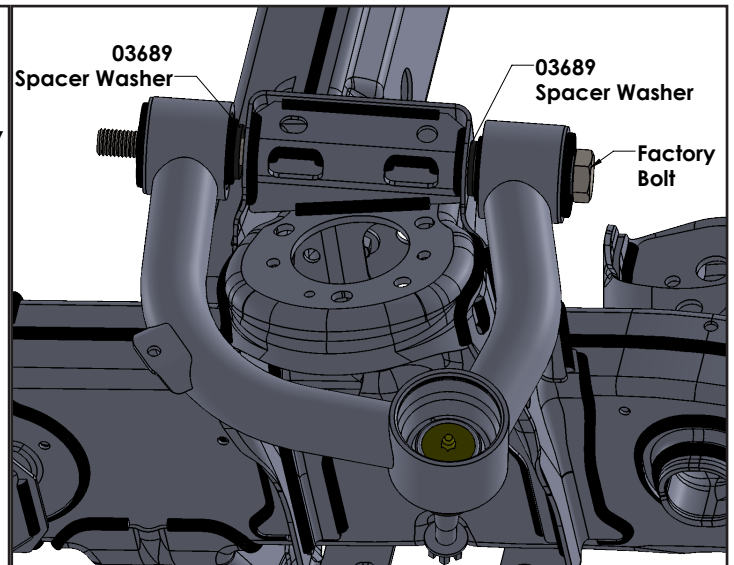

FIGURE 20B



FRONT STRUT SPACER INSTALLATION

31. Support the lower control arm with an appropriate jack. Remove the three upper strut mounting nuts at the frame (Fig. 21). DO NOT remove the center strut rod nut. Discard the hardware.

FIGURE 21



32. Use an air hammer to dislodge the CV shaft from the hub (Fig. 22). Be careful not to hit the threads on the CV shaft.

FIGURE 22



33. Remove the lower strut mount nuts at the lower control arm (Fig. 23A). Lower the control arm and remove the strut from the vehicle (Fig 23B). Save lower strut hardware. Make sure not to overextend any brake or ABS lines. The ABS sensor may need to be removed from the steering knuckle to gain enough slack.

 **Tip** Leave the lower control arm bolts tight to aid in keeping the knuckle assembly from falling.

 **Tip** If a bungee strap was used to support the knuckle it can be removed now. Slowly lower the lower control arm until the strut is removed being careful not to dislodge the CV shaft from the inner joint. The CV shaft can easily be pulled out from the inner joint.

FIGURE 23A

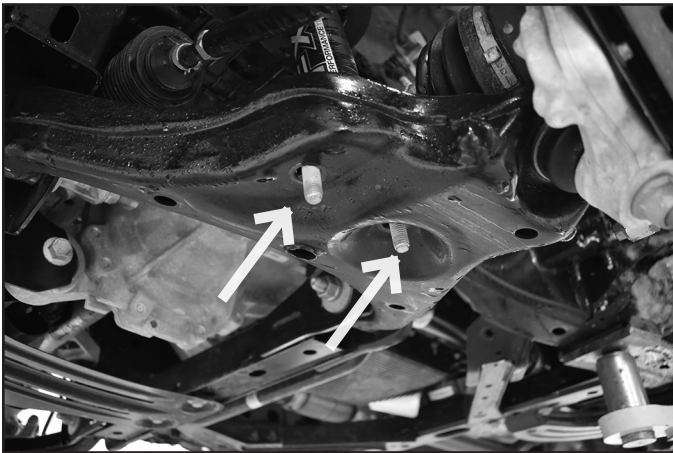
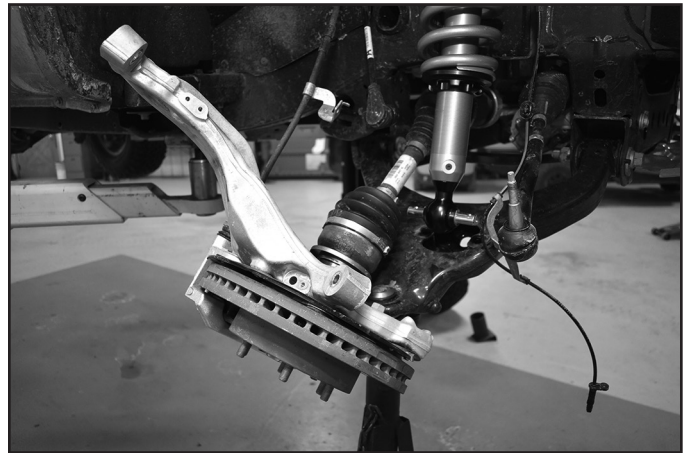

FIGURE 23B



34. Place alignment marks on the upper strut mount, isolator, spring, strut body and lower coil seat for reference when the strut is reassembled (Fig 24A, B, and C).

FIGURE 24A

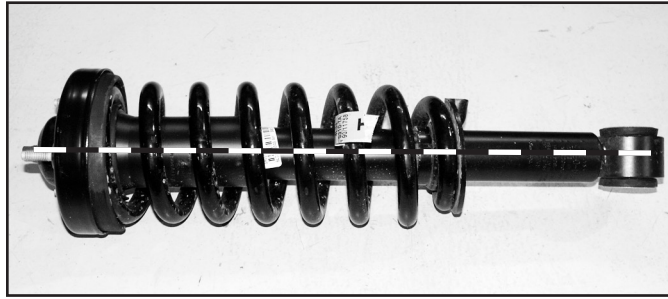

FIGURE 24B



FIGURE 24C



! Caution *Coil Spring is under extreme pressure. Improper removal/installation of coil spring could result in serious injury or death. Use only a high-quality spring compressor and carefully read and follow the manufacturer's instructions.*

35. Using an appropriate strut compressor, compress the coil spring and remove the upper strut nut (Fig 25).

FIGURE 25



36. Remove the lower strut assembly from the strut compressor, the top hat and spring can remain in the strut compressor.
37. Remove the dust boot, bump stop, plastic ring, and the lower spring seat from the strut body (Fig. 26A and B). After fully disassembled the strut should be the same as Figure 26C.

FIGURE 26A



FIGURE 26B

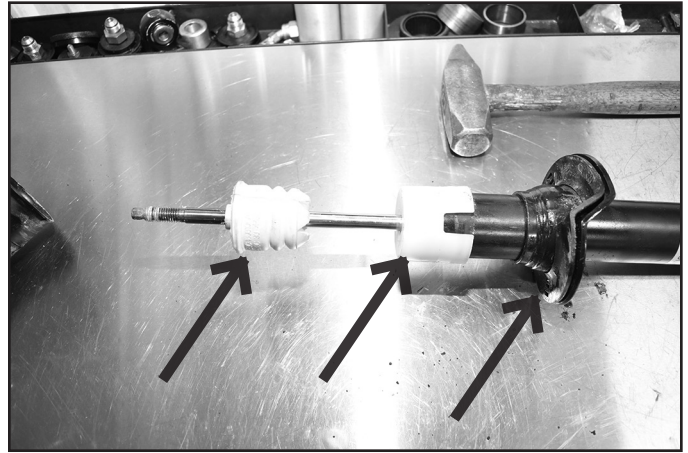

FIGURE 26C



38. Install the preload spacer ring on the strut body such that the groove in the preload spacer goes over the snap ring on the strut body (Fig. 27A.)



Tip

The preload spacer ring may need to be tapped down the strut body. The lower spring seat can be used to help seat the preload spacer all the way down to the snap ring.

39. Reinstall the lower coil seat, plastic ring, bump stop, and dust boot in reverse order (Fig. 27B).

FIGURE 27A



FIGURE 27B



40. Reassemble the strut. Make sure to line up all of the alignment marks, except the top hat of the strut, which must be rotated 180 degrees to install the top strut spacer. Fasten the strut rod with the original nut. Torque nut to 35 ft-lbs.

 **Tip** More preload will need to be put into the spring to reinstall the strut nut.

41. Remove the alignment pin on the top of the strut. This can either be done by cutting the pin or pulling the pin out.

 **Tip** The alignment pin is installed from the factory to ensure the strut is installed on the correct side of the vehicle. Make sure the struts are marked for which side of the vehicle they are installed on.

42. Cut the factory studs to an overall length of 1-1/8" (Fig. 28A & B). The top nub will need to be cut off, but the threads will not need to be cut.

FIGURE 28A

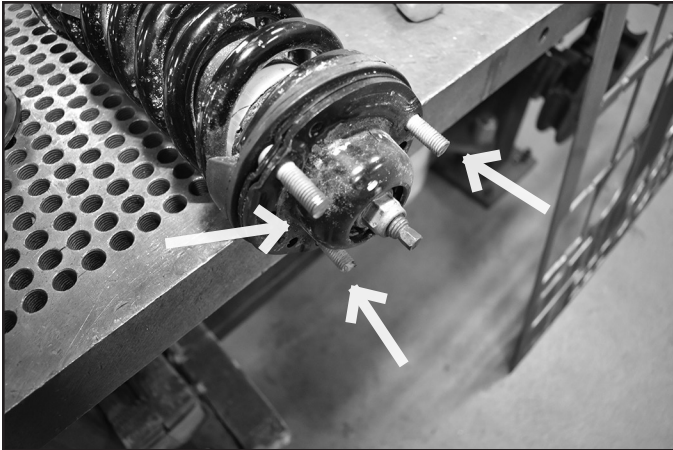
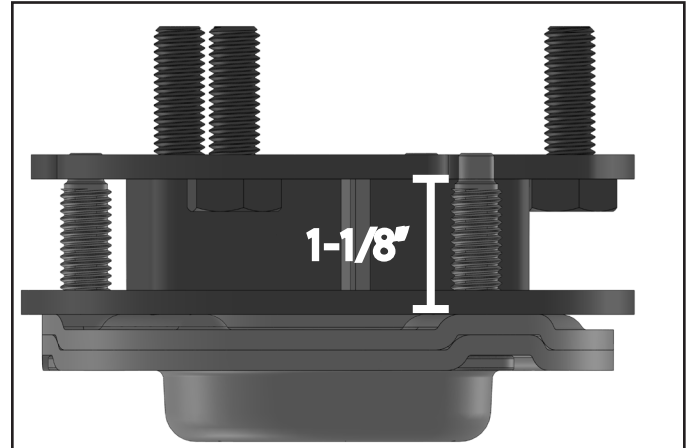
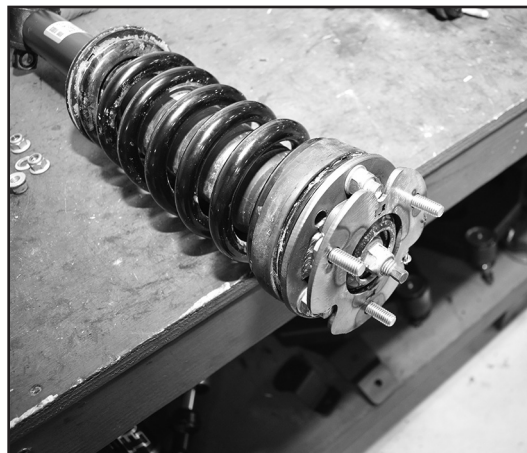

FIGURE 28B



43. Install the upper strut spacer on the strut with the provided 10mm nuts and 10mm washers from Bolt Pack 860 (Fig. 29).

FIGURE 29



44. Install the bottom of the strut back into the original mount with the factory hardware, leave hardware loose.
45. Push down on the lower control arm assembly and install the modified strut assembly into the upper frame mount by aligning the studs in the new spacer with the original mounting holes. Loosely fasten the strut to the vehicle with the factory nuts.

 **Tip** Be careful again to not dislodge the inner CV joint.

46. Torque the upper hardware to 40 ft-lbs. Torque the factory lower hardware to 78 ft-lbs.
47. With the strut installed, reconnect the knuckle to the upper ball joint with the provided nut (Fig. 30B). Torque upper ball joint nut to 32 ft-lbs. Install cotter pin. While connecting the upper ball joint, be sure that the CV shaft properly aligns into the hub (Fig. 30A).

FIGURE 30A

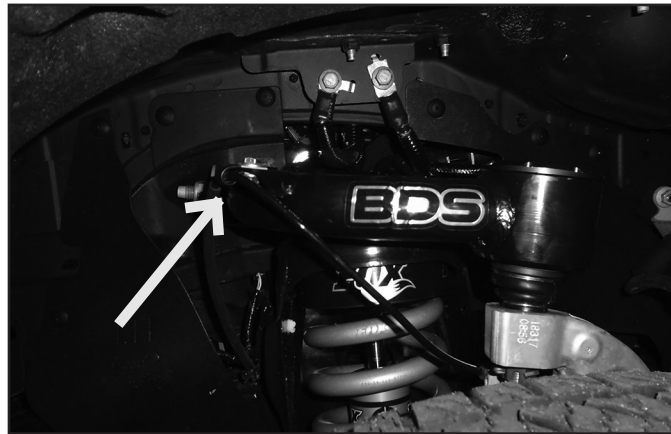

FIGURE 30B



48. GREASE BALL JOINT at this time! Install the o-ring on cap with grease from the included grease packet to aid installation. Install cap. Cap must be removed to access grease fitting for future maintenance.
49. Be sure the CV is properly seated in the hub and reinstall the original retaining nut. Torque nut to 155 ft-lbs.
50. Reconnect the brake line bracket and ABS line to the steering knuckle and frame with the original bolts and nut. Torque hardware to 10 ft-lbs.
51. Attach the steering tie rod end to the steering knuckle with the original nut. Torque to 35 ft-lbs.
52. Remove the factory ABS mounting clips from the ABS line. Attach the ABS wire to the control arm with new 1/4" hardware with new wire clip from Bolt Pack 967. Tighten to 10 ft-lbs (Fig. 31).

FIGURE 31



53. Repeat the installation on the opposite side of the vehicle.
54. With both sides complete, reconnect the sway bar links to the sway bar with the original hardware. Torque to 32 ft-lbs.
55. Install the front wheels and lower the vehicle to the ground. Torque lug nuts to 120 ft-lbs in a crossing pattern.
56. Reinstall wheels. Tighten lug nuts to factory specification. Lower vehicle to the ground. When vehicle is settled at ride height, torque the upper control arm hardware to 85 ft-lbs.
57. Arms give increased caster, a front end alignment is now required. Arms are not recommended for 0" of lift applications.

REAR INSTALLATION

58. Raise the rear of the vehicle and support with jack stands under the frame rails, just ahead of the front leaf spring hangers.
59. Lower the spare tire from under the vehicle enough to allow the rear shackles to be removed.
60. Remove the factory shocks from the axle and frame. Save hardware and discard shocks.
61. Support the rear axle under the differential with a hydraulic jack. Remove the driver's and passenger's rear shackles (Fig. 32). Leave the bushings installed in the leaf springs.

FIGURE 32

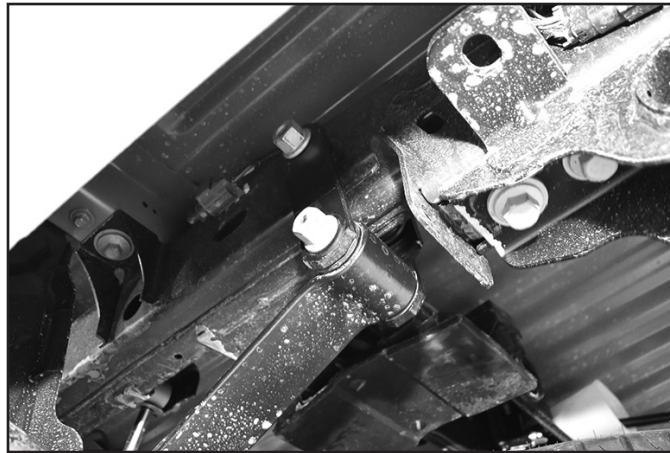

62. Grease and install the longer sleeve (166) in the frame end. Grease and install the shorter sleeve (165) in the leaf spring.
63. Install the provided shackle plates on each frame rail using a 12mm x 150mm bolt, nut and washers. The larger offset shackle plate will install on the inside of the frame rail and will offset the same as the factory shackle (Fig. 33A). The smaller offset shackle plate will install on the outside of the frame and offset inwards the same as the factory shackle. Run the bolt from the inside of the frame outward. Leave hardware loose.
64. With both shackles in place, attach the spring eyes to the bottom holes of the shackle plates with a 12mm x 110mm bolt, nut and washers. Run the bolt from the inside out (Fig. 33A). Adjust the position of the spring eyes relative to the shackles by raising or lowering the axle with the jack. Leave hardware loose.
65. Position the additional spacer sleeve (166) between the shackle plates at the center hole and fasten with a 12mm x 150mm bolt, nut and washers (Fig 33B). Run the bolts from the inside out. Leave hardware loose.

FIGURE 33A

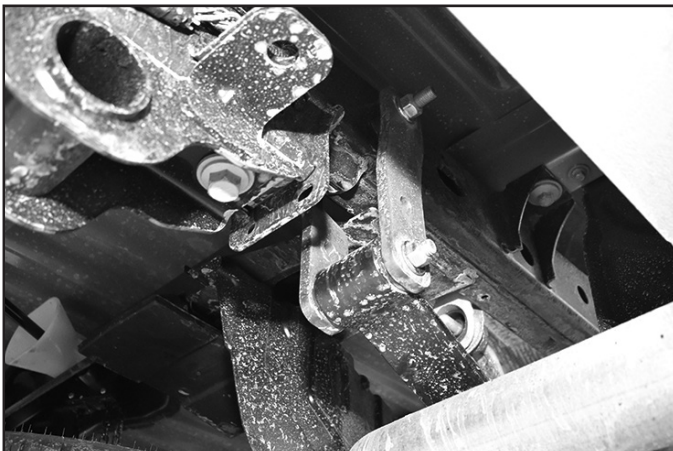
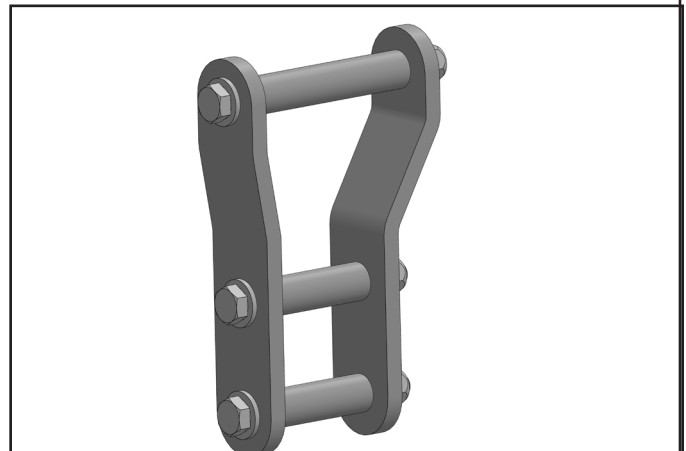

FIGURE 33B



66. Install the new shocks with stock hardware and torque upper and lower bolts to 60 ft-lbs. The axle mounting tabs may need to be bent open slightly to allow for clearance of the larger diameter shocks
67. With the shackles loosely assembled, remove the jack stands and lower the vehicle to the ground. Bounce the rear of the vehicle to settle the suspension and torque all 6 shackle bolts to 75 ft-lbs.
68. Raise the spare tire back to it stowed position.
69. The vehicle will need a complete front end alignment.
70. Check all hardware for proper torque. Check hardware after 500 miles.



WE WANT TO SEE YOUR RIDE!

Grab photos of your BDS-equipped truck in action and send them in for a chance to be featured. Send it in to our Bad Ass Rides customer gallery at bds-suspension.com/bar and post them on the BDS Fan Page on Facebook at facebook.com/BDSSuspensions. Don't forget about your BDS swag! BDS offers t-shirts, hoodies, decals and more available on the BDS website or through your local BDS distributor.

TIME TO HAVE SOME FUN

Thank you for choosing BDS Suspension.

For questions, technical support and warranty issues relating to this BDS Suspension product, please contact your distributor/installer before contacting BDS Suspension directly.

