

# INSTALLATION GUIDE



Part#: 023663



**HARDCORE LIMITED LIFETIME WARRANTY**

## 6" Suspension Systems

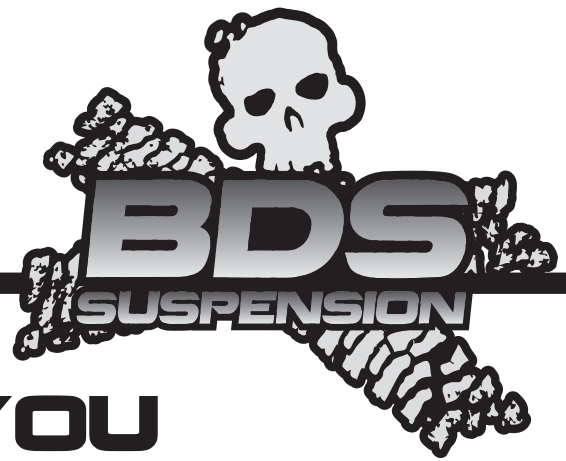
**Ford Ranger 4WD Pickup | 2019**

Rev. 052423

491 W. Garfield Ave., Coldwater, MI 49036 • Phone: 517-279-2135

E-mail: [tech-bds@ridefox.com](mailto:tech-bds@ridefox.com)

# Read And Understand All Instructions And Warnings Prior To Installation Of System And Operation Of Vehicle.



## THANK YOU

Your truck is about to be fitted with the best suspension system on the market today. That means you will be driving the baddest looking truck in the neighborhood, and you'll have the warranty to ensure that it stays that way for years to come. Thank you for choosing BDS Suspension!

### BEFORE YOU START

BDS Suspension Co. recommends this system be installed by a professional technician. In addition to these instructions, professional knowledge of disassembly/ reassembly procedures and post installation checks must be known.

### FOR YOUR SAFETY

Certain BDS Suspension products are intended to improve off-road performance. Modifying your vehicle for off-road use may result in the vehicle handling differently than a factory equipped vehicle. Extreme care must be used to prevent loss of control or vehicle rollover. Failure to drive your modified vehicle safely may result in serious injury or death. BDS Suspension Co. does not recommend the combined use of suspension lifts, body lifts, or other lifting devices. You should never operate your modified vehicle under the influence of alcohol or drugs. Always drive your modified vehicle at reduced speeds to ensure your ability to control your vehicle under all driving conditions. Always wear your seat belt.

### BEFORE INSTALLATION

Special literature required: OE Service Manual for model/year of vehicle. Refer to manual for proper disassembly/reassembly procedures of OE and related components.

Adhere to recommendations when replacement fasteners, retainers and keepers are called out in the OE manual.

Larger rim and tire combinations may increase leverage on suspension, steering, and related components. When selecting combinations larger than OE, consider the additional stress you could be inducing on the OE and related components.

Post suspension system vehicles may experience drive line vibrations. Angles may require tuning, slider on shaft may require replacement, shafts may need to be lengthened or trued, and U-joints may need to be replaced.

Secure and properly block vehicle prior to installation of BDS Suspension components. Always wear safety glasses when using power tools.

If installation is to be performed without a hoist, BDS Suspension Co. recommends rear alterations first.

Due to payload options and initial ride height variances, the amount of lift is a base figure. Final ride height dimensions may vary in accordance to original vehicle attitude. Always measure the attitude prior to beginning installation.

### BEFORE YOU DRIVE

Check all fasteners for proper torque. Check to ensure for adequate clearance between all rotating, mobile, fixed, and heated members. Verify clearance between exhaust and brake lines, fuel lines, fuel tank, floor boards and wiring harness. Check steering gear for clearance. Test and inspect brake system.



Visit [560plus.com](http://560plus.com) for more information.

### TRACTION CONTROL

In an effort to reduce the risk of rollover crashes the National Highway Traffic Safety Administration (NHTSA) established the Federal Motor Vehicle Safety Standard (FMVSS) No. 126 requiring all new passenger vehicles under 10,000 lbs GVWR include an electronic stability control (ESC) system as standard equipment. Effective August 2012 this law requires aftermarket products to be compliant with these same standards.



Perform steering sweep to ensure front brake hoses have adequate slack and do not contact any rotating, mobile or heated members. Inspect rear brake hoses at full extension for adequate slack. Failure to perform hose check/ replacement may result in component failure. Longer replacement hoses, if needed can be purchased from a local parts supplier.

Perform head light check and adjustment.

Re-torque all fasteners after 500 miles. Always inspect fasteners and components during routine servicing.

# CONTENTS OF YOUR KIT

## 023660 / 023661 Knuckle Box Kits

Part #	Qty	Description
03638	1	19+ Ranger Steering Knuckle - DRV
03639	1	19+ Ranger Steering Knuckle - PASS
401-1840	2	Steering Tie Rod End

## 023662 Front Box Kit 1

Part #	Qty	Description
B1308	1	Badge Bag Kit
03586	1	BDS Stainless Steel Badge - Large
97525A505	2	3/16" SS Blind Rivet
B1309	1	Bag Kit
03653	1	Front Drive Shaft Spacer
03654	6	Cam Centering Plate
03744	4	Cam Bolt
03745	8	Cam Washer
857	1	Bolt Pack - Drive Shaft Spacer
	6	8mm-1.00 x 80mm Socket Head Cap Screw, Black Oxide
A344	1	Differential Bracket Assembly
03647	1	Front Cross Member
03648	1	Rear Cross Member
03649	1	Rear Differential Drop - DRV
03743	1	Ranger Differential Mount - PASS
858	1	Bolt Pack - Cross Member
	4	5/8"-11 x 5" Bolt, Grade 8, Yellow Zinc
	8	5/8"-11 Prevailing Torque Nut, Yellow Zinc
	8	5/8" SAE Washer, Yellow Zinc
856	1	Bolt Pack - Front Differential
	2	9/16"-12 x 2" Bolt, Grade 8, Yellow Zinc
	1	9/16"-12 x 4" Bolt, Grade 8, Yellow Zinc
	3	9/16"-12 Prevailing Torque Nut, Yellow Zinc
	6	9/16" SAE Washers, Yellow Zinc
	4	1/2" SAE Thru Hardened Extra Thick Washer, Yellow Zinc
	4	12mm-1.75 x 45mm Bolt, Class 10.9, Clear Zinc
	4	12mm Washer, Clear Zinc
	2	14mm-1.50 x 30mm Hex Bolt, Class 10.9, Clear Zinc
	2	14mm Washer, Clear Zinc
	2	7/16"-14 x 1-1/4" Bolt, Grade 8, Yellow Zinc
	2	7/16"-14 Prevailing Torque Nut, Yellow Zinc
	4	7/16" SAE Washers, Yellow Zinc

## 023664 Strut Spacer Box Kit

Part #	Qty	Description
03757	1	Ranger Strut Spacer - DRV
03758	1	Ranger Strut Spacer - PASS
B1312	1	Bag Kit - Strut Spacer
629	1	Bolt Pack
	6	10mm-1.50 Prevailing Torque Nut, Clear Zinc
	6	3/8" USS Washer, Clear Zinc
02207	2	Preload Spacer

## 023663 Front Box Kit 2

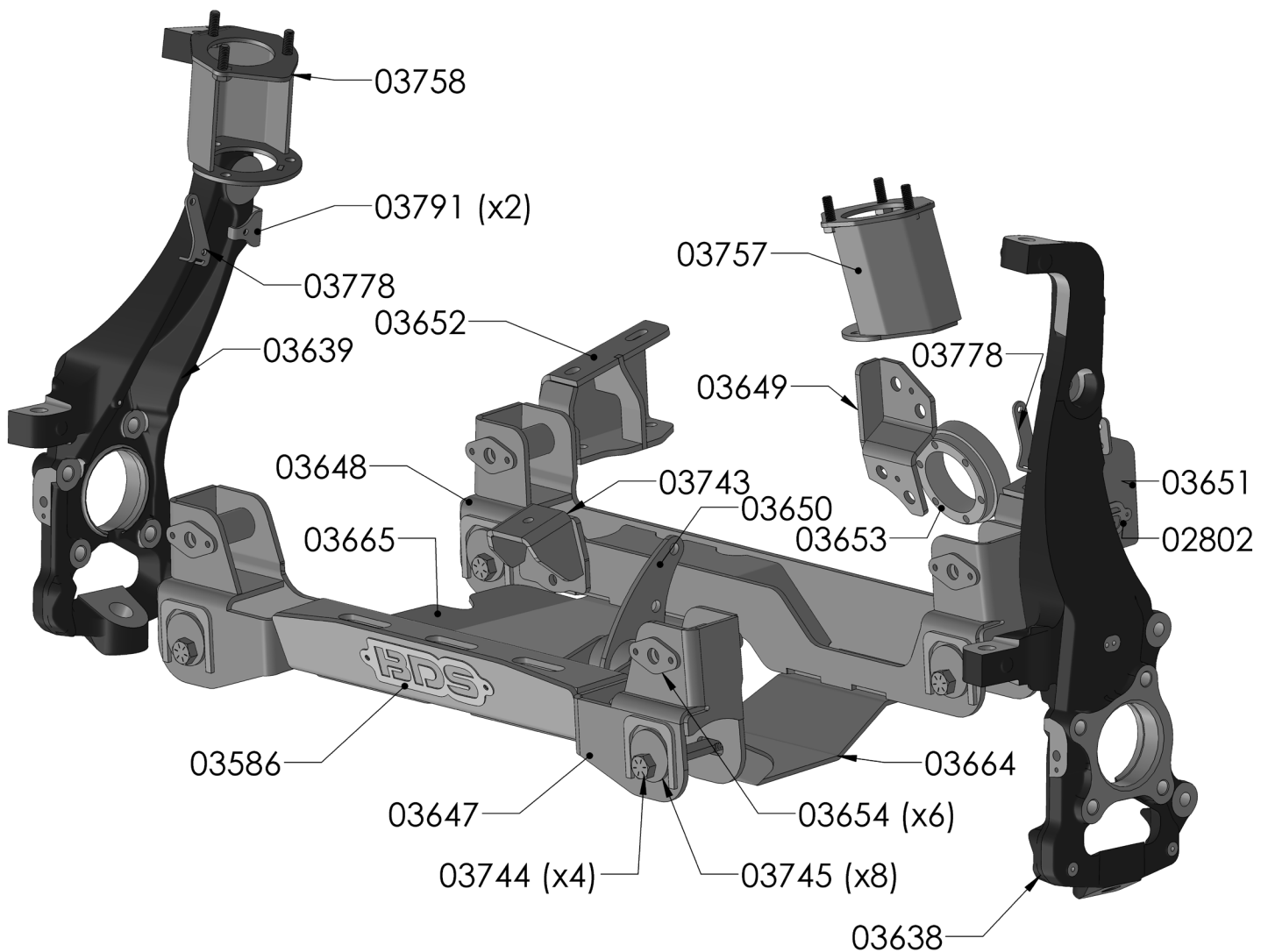
Part #	Qty	Description
B1310	1	Bag Kit
400403-18	1	1/4" ID x 18" Long Vent Hose
859	1	Bolt Pack -Knuckle / Skid Plate
	8	1/2"-13 x 1-1/2" Bolt, Grade 8, Yellow Zinc
	8	1/2" SAE Washers, Yellow Zinc
	4	Wire Clamp
	6	6mm-1.00 x 16mm Bolt, Class 8.8, Clear Zinc
	10	1/4" SAE Washer, Clear Zinc
	2	1/4"-20 x 3/4" Bolt, Grade 5, Clear Zinc
	2	1/4"-20 Prevailing Torque Nut, Clear Zinc
407	1	Bolt Pack - Sway Bar Drop
	8	3/8" USS Washer, Yellow Zinc
	4	7/16"-14 x 1-1/4" Bolt, Grade 8, Yellow Zinc
	4	7/16"-14 Prevailing Torque Nut, Yellow Zinc
03791	2	Knuckle Brake Line Bracket
03777	1	Knuckle ABS Bracket - DRV
03778	1	Knuckle ABS Bracket - PASS
342701	1	Thread Locker
15700143	2	Oval Tree Cable Tie - Black
768	1	Bolt Pack - Knuckle
	2	1/4"-20 x 3/4" Bolt, Grade 5, Clear Zinc
	2	1/4"-20 Nylock Nut, Clear Zinc
	4	1/4" USS Washer, Clear Zinc
B1311	2	Badge Bag Kit
02802	1	BDS Stainless Steel Badge - Small
97525A430	2	1/8" SS Blind Rivet
03664	1	Skid Plate - DRV
03665	1	Skid Plate - PASS
03671	1	Brake Line BRKT - DRV
03672	1	Brake Line BRKT - PASS
03651	1	Sway Bar Drop - DRV
03652	1	Sway Bar Drop - PASS
03836	1	Differential Mount
03837	1	Differential Isolator Mount
M02016BK	1	Large Hourglass Bushing
93	1	.75 x .134 x 1.575 Rolled Sleeve
868	1	Bolt Pack
	1	12mm-1.75 x 80mm Bolt, Class 10.9, Clear Zinc
	2	12mm Flat Washer, Clear Zinc
	1	12mm-1.75 Prevailing Torque Nut, Clear Zinc
	2	1/2"-13 x 2" Bolt, Grade 8, Yellow Zinc
	2	1/2"-13 Serrated Edge Nut, Yellow Zinc
	3	12mm-1.75 x 40mm Bolt - Class 10.9 - Clear Zinc
	3	12mm Washer - Clear Zinc

### 023669 Rear Box Kit

Part #	Qty	Description
B1313	1	Bag Kit - Rear Components
54314	1	.625 x .060 x 1.475 Sleeve
03774	1	ABS Wire Relocation
03775	1	E-Brake Cable Relocation - DRV
03776	1	E-Brake Cable Relocation - PASS
865	1	Bolt Pack- Rear
N96FH-B	8	9/16" Fine High Nut- Black
W96S-B	8	9/16" SAE Flat Washer-Black
03798	1	Carrier Bearing Drop
03800	1	Transfer Case Cross member
03801	2	Transfer Case Cross member Brace
03799	2	3-5/8in Rear Block
962961138QB	4	9/16 x 2-9/16 x 11-3/8 Square Black U-Bolt

### 023669 (Bolt Pack)

Part #	Qty	Description
865	1	Bolt Pack - Rear
	1	8mm-1.25 x 55mm Hex Bolt, Clear Zinc, Class 8.8
	1	5/16" SAE Washer, Clear Zinc
	4	10mm-1.50 x 30mm Hex Bolt, Class 10.9, Clear Zinc
	2	3/8" Thick Washer
	6	3/8" USS Washer, Clear Zinc
	2	10mm-1.50 Prevailing Torque Nut, Clear Zinc
	1	5/16"-18 x 1" Bolt, Grade 5, Clear Zinc
	2	5/16"-18 x 3/4" Bolt, Grade 5, Clear Zinc
	2	5/16"-18 Prevailing Torque Nut, Clear Zinc
	5	5/16" SAE Washer, Clear Zinc
	1	5/16"-18 Serrated Edge Flange Nut, Clear Zinc
	1	1/4"-20 x 3/4" Bolt, Grade 5, Clear Zinc
	1	1/4"-20 Prevailing Torque Nut, Clear Zinc
	2	1/4" SAE Washer, Clear Zinc
	4	7/16"-14 x 1" Bolt, Grade 5, Clear Zinc
	4	7/16" SAE Washer, Clear Zinc
	4	7/16"-14 Serrated Edge Flange Nut, Clear Zinc
	2	3/8"-16 x 1" Bolt, Grade 5, Clear Zinc
	2	3/8"-16 Serrated Edge Flange Nut, Clear Zinc



## TROUBLESHOOTING INFORMATION FOR YOUR VEHICLE

1. Requires frame bracket and differential modification. If using a plasma cutter for frame bracket modification, disconnecting the battery is highly recommended.
2. BDS Intrusion Beams (BDS123614) are highly recommended to increase tire clearance.
3. Stock 17" & 18" wheels cannot be reinstalled with the lift kit.
4. When balancing, wheel weight are best positioned towards the center of the wheel to avoid interference with the tie rod end on 17" & 18" wheels.
5. Rack and Pinion steering is sensitive to tire choice. Tires with large lugs, little backspacing, or extreme amounts of weight may induce a steering wheel wobble.
6. Add 1/2 quart of Ford recommended gear lube to the front differential during install of this suspension system.

**TECH  
TIPS**

## TIRES AND WHEELS

BS = Back Space, All sizes are up to the listed size, BDS Intrusion Beams Recommended for Max Tire Clearance (BDS123614). A tire wider than listed for each back space will rub on the inner part of the frame. A tire wider than a 285 on 6.18" BS will not clear the steering knuckle.

### **6" Lift with Factory Intrusion Beam:**

285/65 Tires on 20x9 Wheels with 6.18" BS  
35 x 12.50 Tires on 20x9 Wheels with 5.5" - 5.75" BS  
305/65 18x9, 305/55 20x9 Wheels with 5" BS  
33 x 12.50 17x9, 18x9, 20x9 Wheels with 4.5" BS

### **6" Lift with BDS Intrusion Beam:**

285/65 Tires on 20x9 Wheels with 6.18" BS  
35 x 12.50 Tires on 20x9 Wheels with 5" - 5.75" BS  
35 x 12.50 Tires on 18x9 Wheels with 5" BS  
305/70 17x9, 305/65 18x9, 305/55 20x9 Wheels with 4.5"-5.75" BS



## INSTALLATION INSTRUCTIONS

### MEASURE FIRST

Measure from the center of the wheel up to the bottom edge of the wheel opening:

LF \_\_\_\_\_ RF \_\_\_\_\_

LR \_\_\_\_\_ RR \_\_\_\_\_

### SPECIAL TOOLS

35mm Socket - Hub Nut  
Air Hammer  
Plasma Cutter or Sawzall  
Front Differential Gear Lube

### FRONT DISASSEMBLY

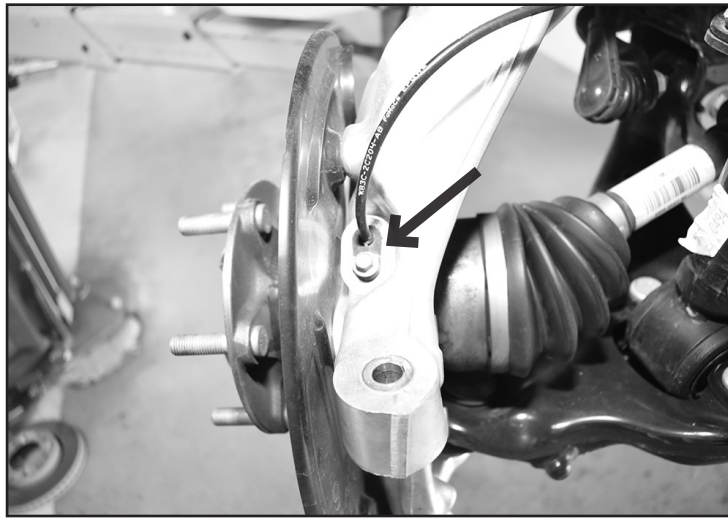
1. Park the vehicle on a clean, flat surface and block the rear wheels for safety.
2. Disconnect the positive and negative battery cables from the battery.
3. Raise the front of the vehicle with a hydraulic jack and support the frame with jack stands. Remove the wheels.



**Caution** *Disconnect the power steering control module connector to avoid arcing of the contacts in the internal power relay from a hammer blow or impact wrench.*

4. Remove the ABS sensor from the steering knuckle. Save the bolt for later installation.

**FIGURE 1**



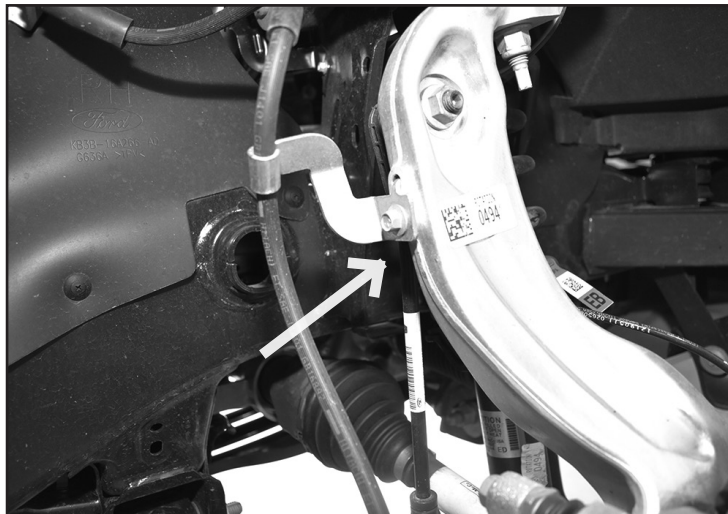
5. Remove the ABS line from the retaining clips at the frame, upper control arm and knuckle (Fig. 2). Remove the ABS sensor line from the ABS bracket. Discard the bolts and the ABS bracket.

**FIGURE 2**



6. Disconnect the brake line bracket from the knuckle (Fig. 3). Discard the bolts.

**FIGURE 3**



7. Remove the clip holding the brake line to the brake line bracket. Remove the nut attaching the brake line bracket to the frame. Carefully cut the factory bracket so that the brake line can be removed without breaking loose the fitting. Remove the factory brackets from the vehicle. Do not damage the brake line! (Fig. 4)

**FIGURE 4**



8. Remove the factory splash guards from the vehicle (Fig. 5).

**FIGURE 5**



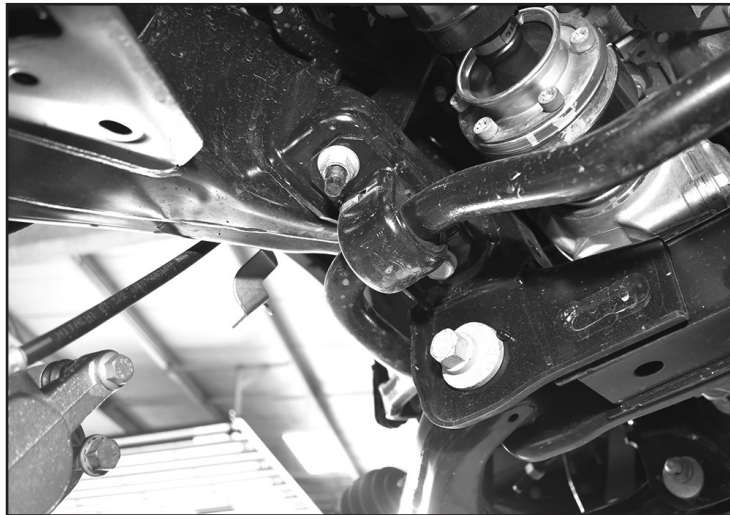
9. Remove the sway bar links from the sway bar and the knuckle (Fig. 6).

**FIGURE 6**



10. Mark the orientation of the sway bar and remove it from the frame by removing the two bolts and two nuts for the bushing cap (Fig. 7). Save all sway bar components, including the hardware.

**FIGURE 7**



11. Break loose the jam nut for the factory tie rod. Disconnect the tie rod from the knuckle by removing the nut (Fig. 8.). Remove the outer tie rod from the vehicle and discard the tie rod. **Aluminum Knuckle:** Avoid striking the knuckle, typically the taper unseats more easily and gently hitting the end of the tie rod end will unseat the taper. A pickle fork can also be used.



**FIGURE 8**



12. Remove the two brake caliper mounting bolts and remove the caliper from the knuckle (Fig. 9). Hang the caliper securely out of the way DO NOT hang the caliper by the brake hose. Save caliper bolts.

**FIGURE 9**



13. Remove the rotor from the vehicle.
14. Remove the axle shaft nut. Retain nut (Fig. 10).



**Tip** *The axle nut will require a 35mm socket.*

**FIGURE 10**

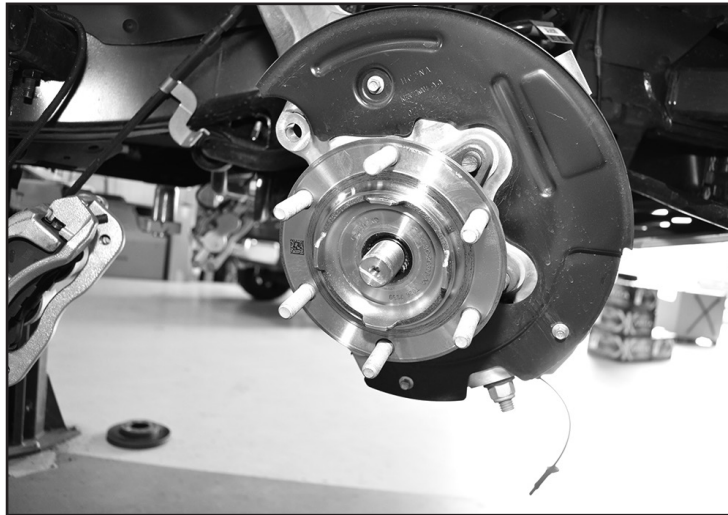


15. Dislodge the CV shaft from the hub assembly (Fig. 11).



**Tip** *An air hammer may be needed to help dislodge the CV axle from the hub assembly.*

**FIGURE 11**



16. Remove the upper ball joint nuts and thread back on by hand a couple of turns. **Aluminum Knuckle:** Avoid striking the knuckle to release the taper, a pickle fork or pry bar can be used to apply a splitting force. Gently hit the end of the ball joint to get it to release. If you do resort to hitting the knuckle avoid re-use and discard.
17. Remove the upper ball joint nut (Fig. 12A) and continue to remove the CV shaft from the hub assembly (Fig. 12B). Save the upper ball joint nut.



**Tip** *Be sure to support the CV axle after removal of the hub assembly and steering knuckle. It is easy to dislodge the CV axle from the inner joint. If this happens lightly tap on the end of the CV shaft with a dead blow hammer to reinsert the inner joint into the cup.*

**FIGURE 12A**

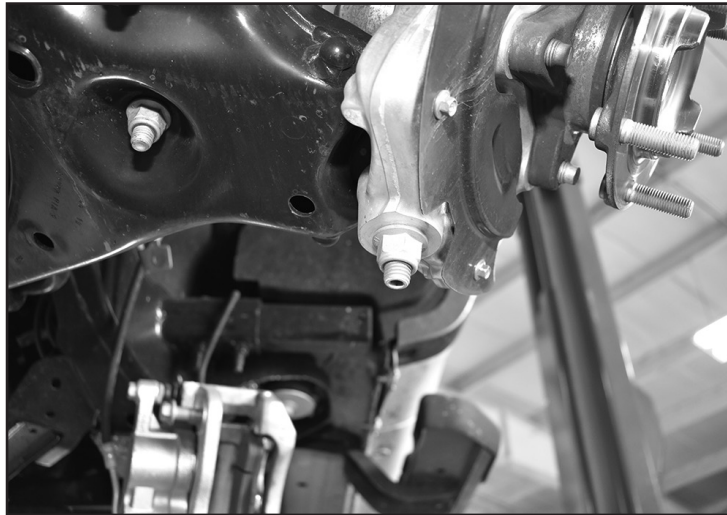


**FIGURE 12BA**



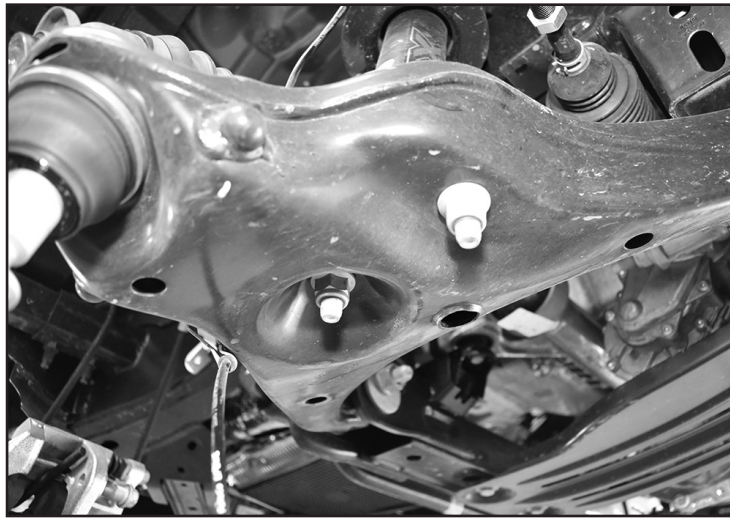
18. Remove the lower ball joint nuts and thread back on by hand a couple of turns. **Aluminum Knuckle:** Avoid striking the knuckle to release the taper, a pickle fork or pry bar can be used to apply a splitting force. Gently hit the end of the ball joint to get it to release. If you do resort to hitting the knuckle avoid re-use and discard.
19. Remove the lower ball joint nut (Fig. 13) and remove the steering knuckle assembly from the vehicle. Save the lower ball joint nut.

**FIGURE 13**



20. Mark each of the front strut bodies to indicate driver's versus passenger's side. Support the lower control arm with a jack. Remove the lower strut nuts (Fig. 14). Save nuts.

**FIGURE 14**



21. Remove the front and rear lower control arm mounting bolts and remove the lower control arm from the vehicle (Fig. 15A & B). Discard the cam bolts for the lower control arm.

**FIGURE 15A**



**FIGURE 15B**



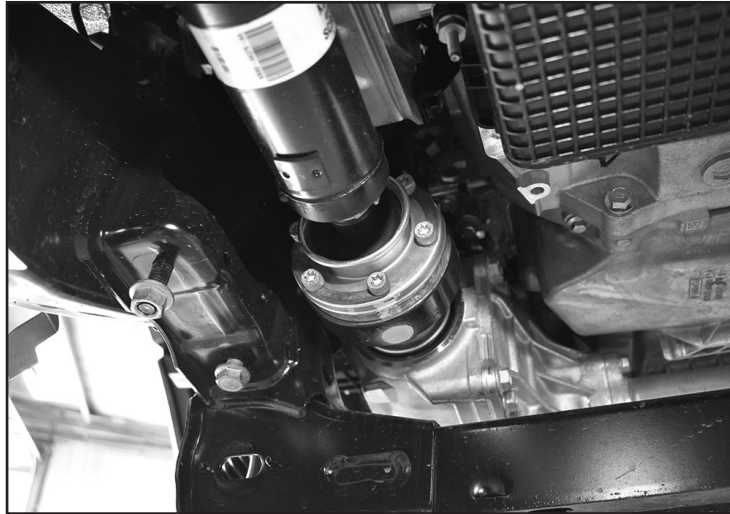
22. Remove the three upper strut mounting nuts (Fig. 16) and remove the strut from the vehicle. DO NOT remove the center strut rod nut, it is under extreme pressure. Save nuts.

**FIGURE 16**



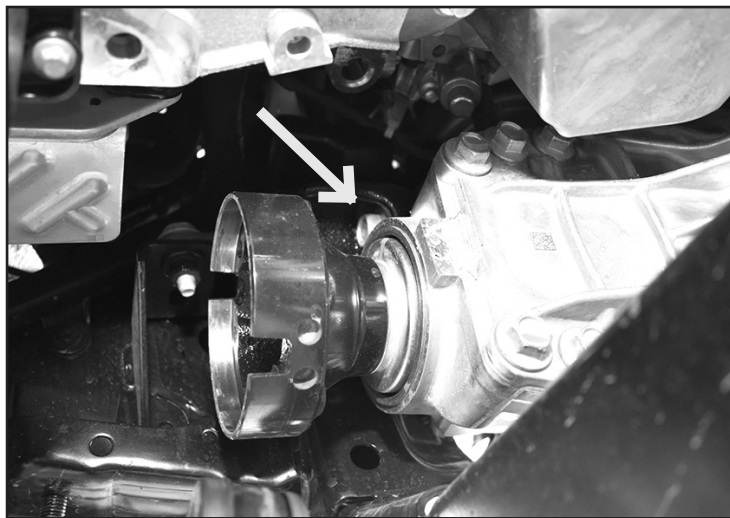
23. Make an alignment mark to show the relationship between the front drive shaft and the differential yoke. Remove the six drive shaft bolts and disconnect the drive shaft from the differential. Discard bolts (Fig. 17).

**FIGURE 17**



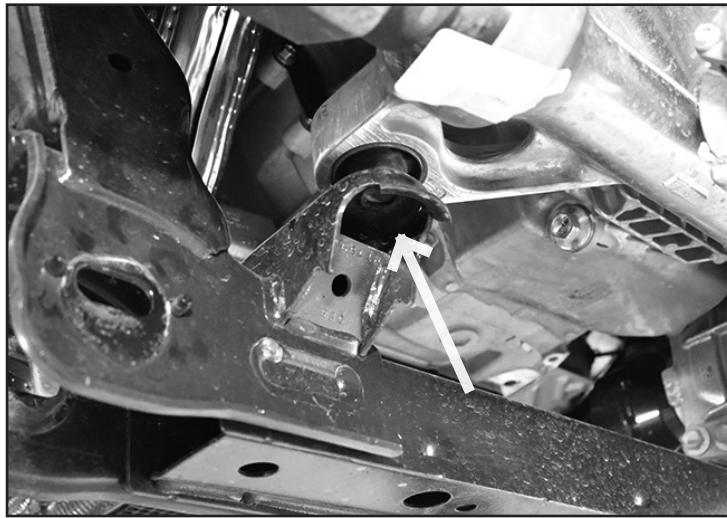
24. Disconnect the differential breather hose from the top / front side of the differential.  
25. Support the differential with an appropriate jack. Remove the two driver's side rear differential mounting bolts (Fig. 18). Discard bolts.

**FIGURE 18**



26. Remove the passenger's side mounting bolt and nut tab. Save mounting hardware (Fig. 19).

**FIGURE 19**



27. Remove the front differential bolt. The inner side of the differential mount can also be removed to aid in differential removal (Fig. 20). Discard bolt and nut plate. Remove the differential from the vehicle and set aside for modification.

**FIGURE 20**

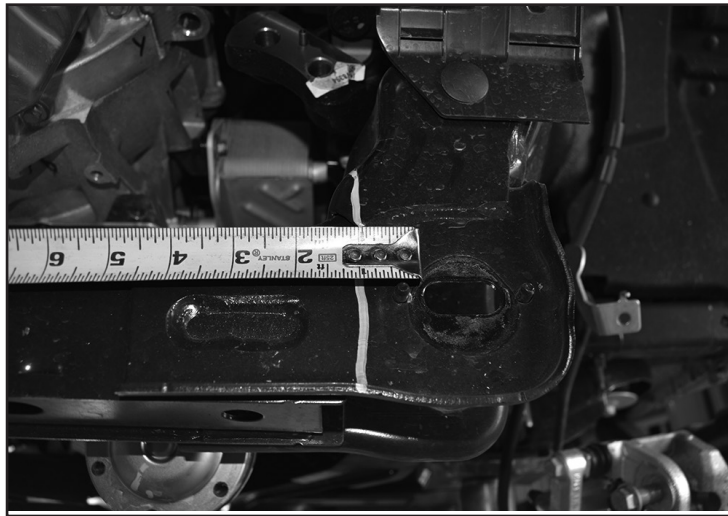


**Tip**

*We highly recommend having an assistant to help with removal of the front differential. The differential can be tipped forward around the rear cross member to remove it from the vehicle. Make sure to not tip it far enough to spill fluid out of the breather.*

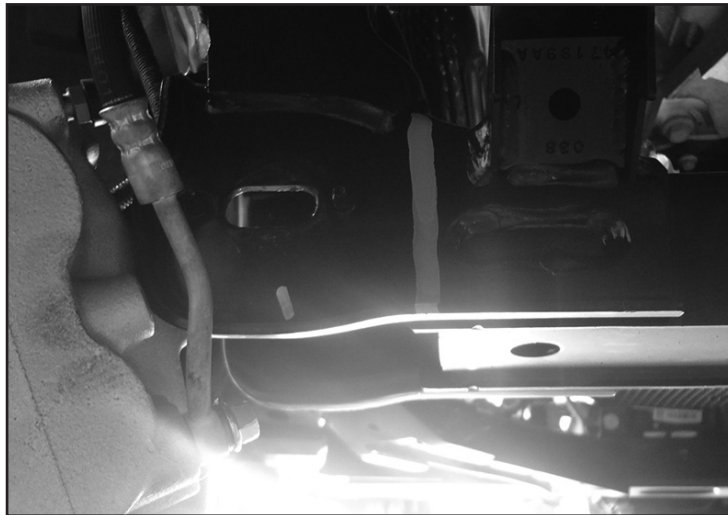
28. The rear cross member must be cut to provide clearance for the front differential in the relocated position. This area needs to be cleaned of any oil, grease and/or undercoating. These coatings are flammable.
29. Measure from the inside of the driver's side control arm slot 1" and mark. Repeat this measurement on the back side of the pocket. Make vertical cut lines at the 1" mark up both front and back faces of the pocket (Fig. 21).

**FIGURE 21**



30. Measure from the inside of the passenger's side control arm slot 1" and mark (Fig. 22). Repeat this measurement on the back side of the pocket. Make vertical cut lines at the 1" mark up both front and back faces of the pocket.

**FIGURE 22**

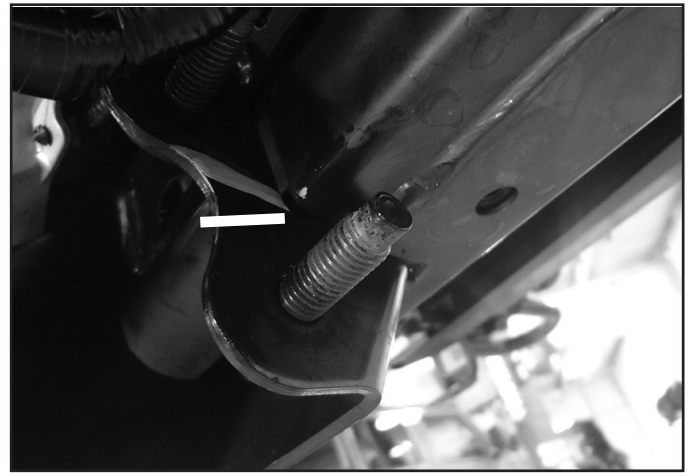


31. Make a vertical cut along each of the cut lines on the front and back faces of the control arm pocket with a reciprocating saw (recommended), cut-off wheel or plasma cutter. Be careful, the undercoating on the frame is flammable and can melt and drip off the frame. Keep a fire extinguisher near by.
32. With the vertical cuts complete, cut the top portion of the pocket by connecting the two cuts. Remove the factory rear cross member from the vehicle.
33. The front differential mount needs to be trimmed for clearance to the new front cross member. Trim the differential mount as shown in Figures 23A & 23B so that no part of the differential mount hangs below the factory front cross member.

**FIGURE 23A**



**FIGURE 23B**



34. With all the frame cuts complete clean up all the cuts with a grinder and paint any exposed metal.

## DIFFERENTIAL MODIFICATION

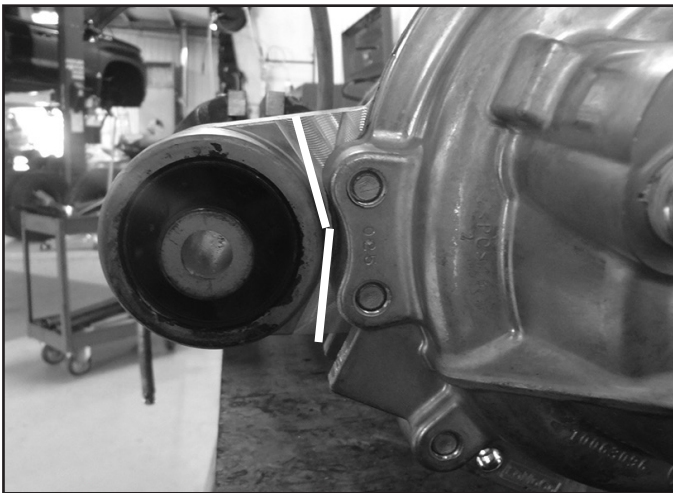
35. The differential housing needs to be modified to provide additional ground clearance and provide a new higher mounting point for the front differential. Mark the passenger side mount as shown in Figure 24 and using a reciprocating saw make 2 cuts perpendicular to the mounting surface (Fig. 24A & B).



**Tip**

*A wood type blade on a reciprocating saw works best when cutting the aluminum mount.*

**FIGURE 24A**



**FIGURE 24B**



36. Clean up the cuts with a sanding disc or flap wheel. Be sure to remove the remaining material on the outside flange so it matches the contour of the new differential bracket (Fig. 25).



**FIGURE 25**



37. Locate the new differential bracket and 12mm x 45mm bolts, 12mm washers, and 1/2" SAE "Thick" Washers. Remove the 4 housing bolts and install the differential bracket with the provided hardware using some thread locker. Torque bolts to 60 ft-lbs. Take care not to break the gasket seal (Fig. 26A & B).

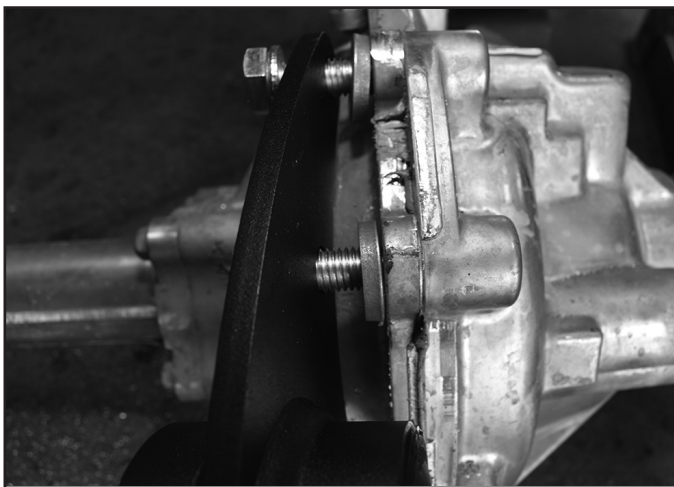


**Tip** Make sure the differential bracket sits flush in all locations on the differential additional grinding may be needed to ensure the bracket is sitting flush on the mounting surface.

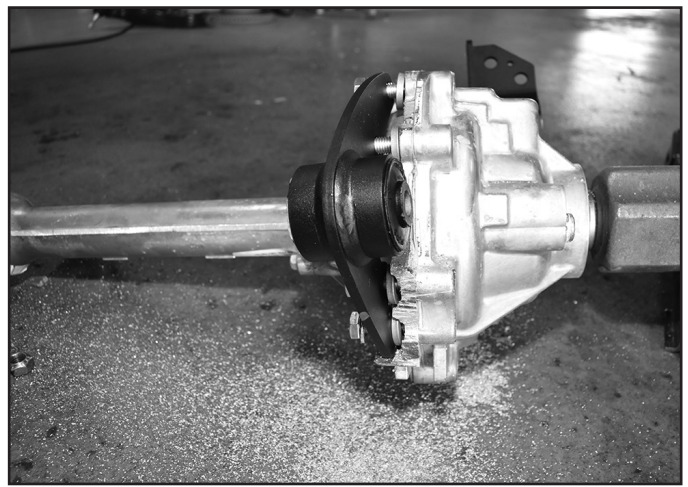


**Tip** Hardware for the differential brackets are located in bolt pack 856.

**FIGURE 26A**



**FIGURE 26B**



38. Install the new driver's side rear differential bracket to the original mount on the differential with the provided 14mm-1.50 bolts and 14mm washers (Fig. 27A). Torque each bolts to 30 ft-lbs and then an additional 70deg per the factory specification. Sand down the corner of the differential so that it is flush with the edge of the bracket (Fig. 27B).
39. Remove the fill plug on the side of the differential and add 1/2 quart of Ford recommended gear lube to the front differential.

**FIGURE 27A**



**FIGURE 27B**



## DIFFERENTIAL INSTALLATION

40. Install the front cross member in the control arm pockets with the provided 5/8" bolts, nuts and washers and the cam centering plates on both the front and rear of the control arm pockets. The two outer holes on the plates will line up with the two pins on the frame. When installed, the tabs for the differential will point towards the rear of the vehicle. Run bolts from front to rear. Leave hardware loose (Fig. 28A & B).

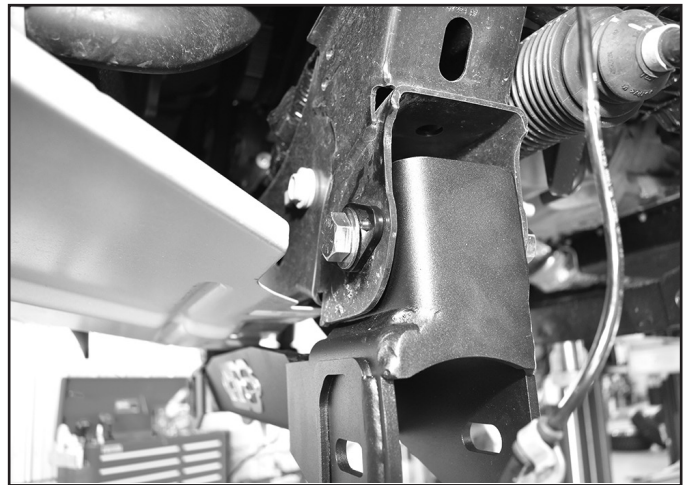


**Tip** Hardware for the front cross member is located in bolt pack 858.

**FIGURE 28A**



**FIGURE 28A**

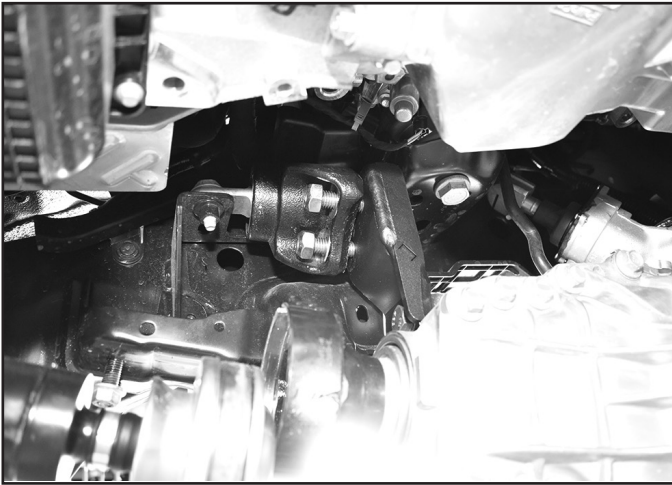


41. Raise the differential into the truck and install the differential to the driver's side rear factory differential mount with the two provided 9/16" x 2" bolts, washers, and nuts (Fig. 29A). Install the front differential mount into the pocket on the front cross member with the provided 9/16" x 4" bolt, washers, and nuts. Leave hardware loose (Fig. 29B).

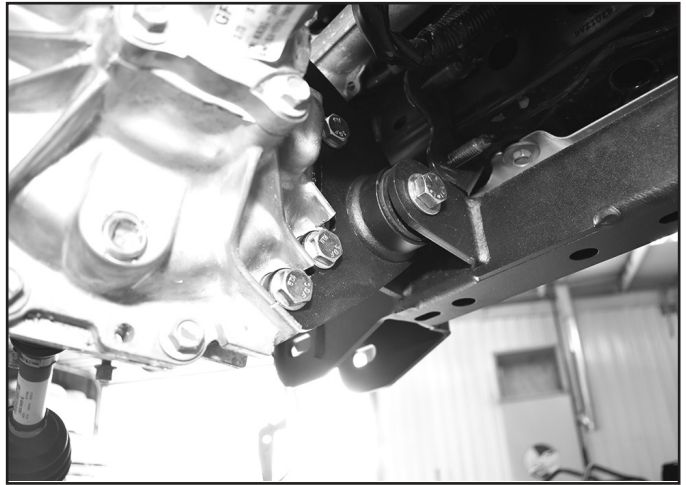


**Tip** Hardware for the differential drop brackets is located in bolt pack 856.

**FIGURE 29A**



**FIGURE 29B**



42. Install the differential mount onto the rear cross member using the 7/16" hardware (Fig. 30). Tighten 7/16" hardware to 55 ft-lbs.



**Tip** Hardware for the differential brackets is located in bolt pack 856.

**FIGURE 30**



43. Install the new rear cross member with the provided 5/8" bolts, nuts and washers and the cam centering plates on only the front side of the control arm pockets (Fig. 31A). The bolts must run from front to the rear. Leave hardware loose. Be sure to check the clearance between the differential and frame as shown in Figure 31B. Additional clearance may be need to provide a minimum of 1/4" of clearance between the frame and differential.



**Tip** Hardware for the rear cross member is located in bolt pack 858.



**Tip** We highly recommend having an assistant to help with installation of the rear cross member.

**FIGURE 31A**



**FIGURE 31B**



44. Install the factory 10mm bolt and nut tab on the passenger side rear differential mount. The nut tab will need to be trimmed to be used. Leave hardware loose.

**FIGURE 32**

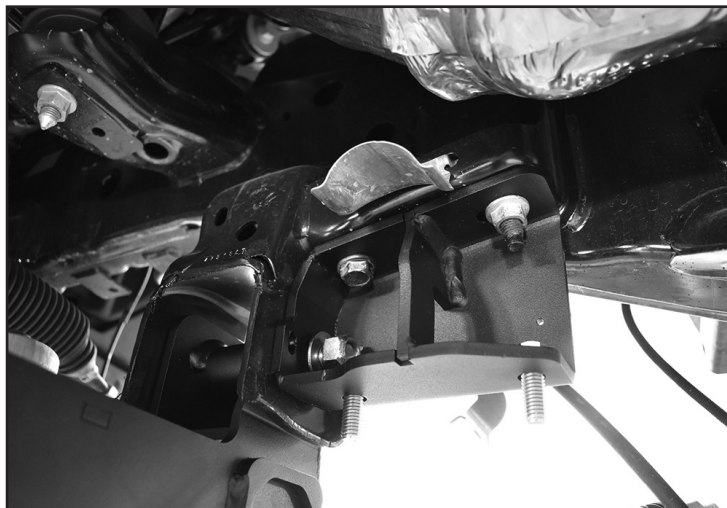


45. Install the sway bar drop brackets into the factory sway bar location. Attach the sway bar drop bracket to the frame stud with the factory nut and factory bolt along with the 5/8" bolt for the rear cross member. The 5/8" nut and washer will need to be removed and installed again on the inside of the sway bar drop bracket as shown in Figure 33. Snug up hardware, but do not torque hardware. Install the 7/16" bolts and washers top down at this time into the sway bar drop bracket as shown in Figure 33.



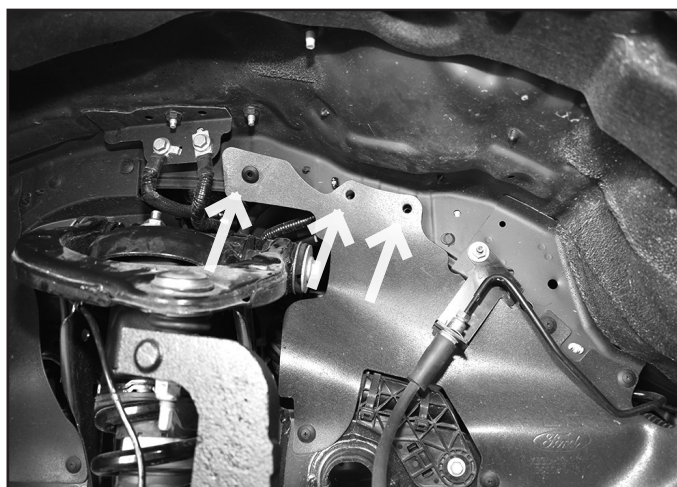
**Tip** Hardware for the sway bar drop is located in bolt pack 407.

**FIGURE 33**



46. Remove the front differential breather bracket from the side of the engine. This can be accessed through the driver's side fender well near the steering shaft (Fig. 34A & B).

**FIGURE 34A**

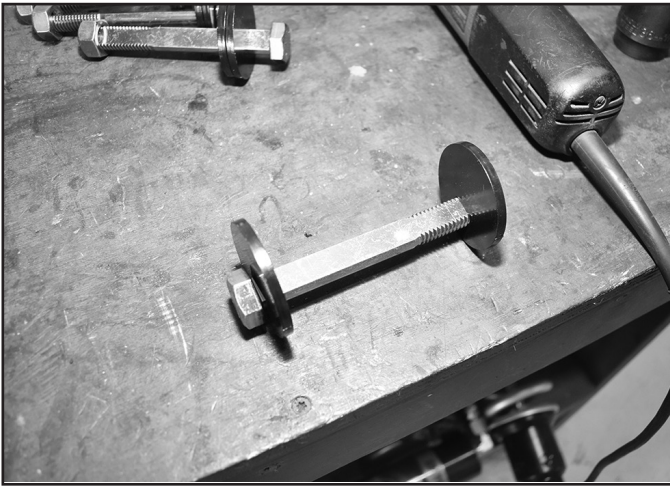


**FIGURE 34B**



47. Remove the factory rubber breather line. Install the provided longer rubber differential breather line to the differential breather bracket. Reattach the differential breather line to the top side of the differential.
48. Install the OE lower control arms in the new cross members and fasten with the new cam bolts and cam washers (Fig. 35A). Run both bolts from front to rear (Fig. 35B). Leave hardware loose.

**FIGURE 35A**




**FIGURE 35B**



49. With the cross members, differential, and control arms installed, go back and torque the 5/8" cross member mounting bolts to 180 ft-lbs, 9/16" differential bolts to 130 ft-lbs, 10mm differential bolt to 52 ft-lbs, and factory sway bar hardware to 66 ft-lbs.
50. Install the supplied drive shaft spacer and reattach front drive shaft to differential with new 8mm hardware and thread locker. Torque bolts to 21 ft-lbs (Fig. 36).


 **Tip** Hardware for the drive shaft spacer is located in bolt pack 857.

 **Tip** Be sure to line up the marks on the drive shaft from the previous step.

**FIGURE 36**



51. Loosely attach the differential skid plates to the rear cross member with (2) 1/2" x 1-1/2" bolts on the passenger's side and the 1/2" x 2" fully threaded bolts on the driver's side and 1/2" SAE washers into the threaded holes in the cross members. Install the skid plate to the front cross member with (4) 1/2" x 1-1/2" bolts and 1/2" SAE washers. Tighten hardware to 60 ft-lbs. (Fig. 37)

 **Tip** Hardware for the differential skid plate is located in bolt pack 859 and 868 for the fully threaded bolts on the driver's side rear crossmember.

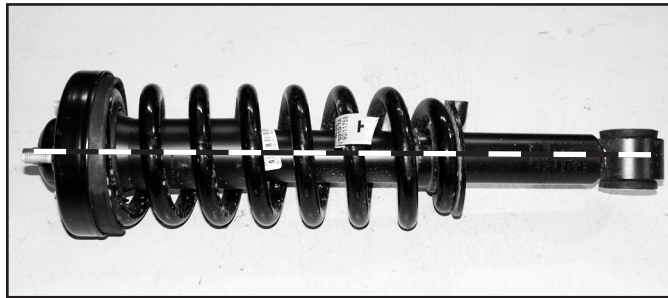
**FIGURE 37**



## FRONT ASSEMBLY

52. Place alignment marks on the upper strut mount, isolator, spring, strut body and lower coil seat for reference when the strut is reassembled (Fig 38A, B, and C).

**FIGURE 38A**



**FIGURE 38B**



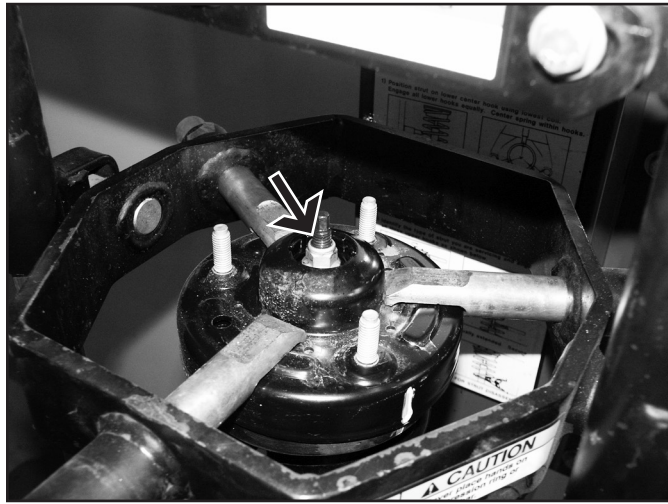
**FIGURE 38C**



**! Caution** *Coil Spring is under extreme pressure. Improper removal/installation of coil spring could result in serious injury or death. Use only a high-quality spring compressor and carefully read and follow the manufacturer's instructions.*

53. Using an appropriate strut compressor, compress the coil spring and remove the upper strut nut (Fig 39).

**FIGURE 39**

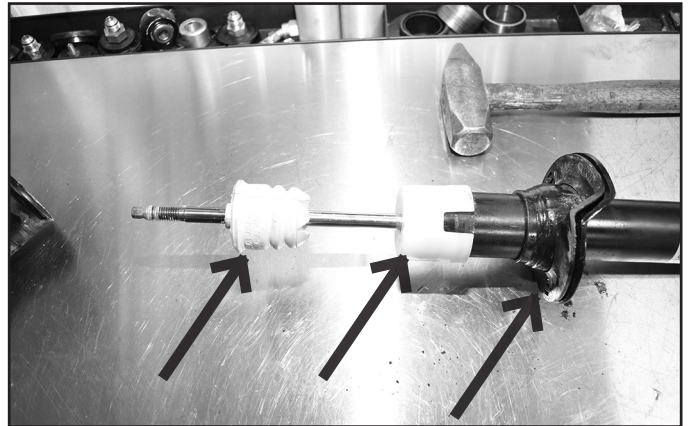


54. Remove the lower strut assembly from the strut compressor, the top hat and spring can remain in the strut compressor.
55. Remove the dust boot, bump stop, plastic ring, and the lower spring seat from the strut body (Fig. 40A and B). After fully disassembled the strut should be the same as Figure 40C.

**FIGURE 40A**



**FIGURE 40A**



**FIGURE 40C**



56. Install the preload spacer ring on the strut body such that the groove in the preload spacer goes over the snap ring on the strut body (Fig. 41A.)



**Tip** *The preload spacer ring may need to be tapped down the strut body. The lower spring seat can be used to help seat the preload spacer all the way down to the snap ring.*



57. Reinstall the lower coil seat, plastic ring, bump stop, and dust boot in reverse order (Fig. 41B).


**FIGURE 41A**




**FIGURE 41B**



58. Reassemble the strut. Make sure to line up all of the alignment marks, except the top hat of the strut, which must be rotated 180 degrees to install the top strut spacer. Fasten the strut rod with the original nut. Torque nut to 41 ft-lbs.

 **Tip** *More preload will need to be put into the spring to reinstall the strut nut.*

59. Install the new strut spacer to the strut with the factory nuts. The strut spacers are side dependent to shift the strut backwards in the coil bucket. Torque the nuts to 40 ft-lbs. The alignment pin will need to be removed from the strut before the strut spacer can be installed (Figure 42C). As shown in Figure 42A & B, this is the driver side strut, with the 03757 strut spacer installed shifting the strut towards the rear of the vehicle.

 **Tip** *Use a 3/8" chrome 15mm socket with a 3/8" swivel to tighten the nut inside the strut spacer.*

**FIGURE 42A**



**FIGURE 42B**



**FIGURE 42C**



60. Install the strut assembly into the vehicle, loosely attaching the strut spacer to the frame using the 10mm nuts and 3/8" USS washers.

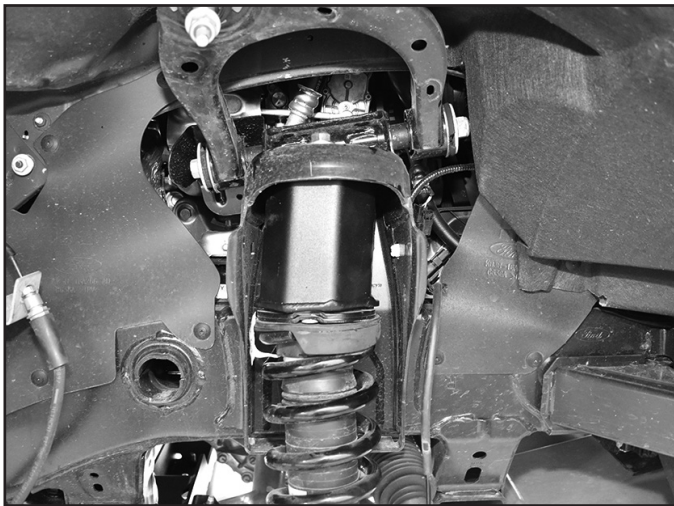


**Tip** Hardware for the strut spacer is located in bolt pack 629.

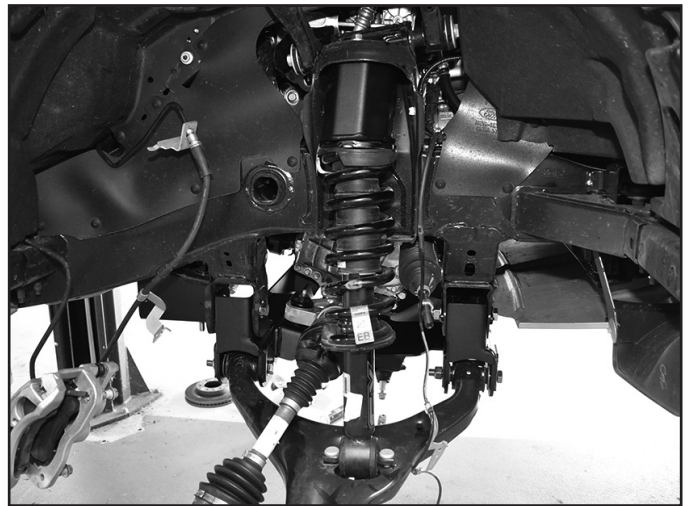
61. Swing the lower control arm up to the strut and fasten it with the original mounting bolts (Fig. 43A & B). Torque the upper strut hardware to 41 ft-lbs. Torque the lower strut nuts to 66 ft-lbs.

*Note: Figure 43A shows the passenger side strut assembly installed properly with the strut spacer offsetting the strut towards the rear of the vehicle.*

**FIGURE 43A**



**FIGURE 43B**



## STEERING KNUCKLE ASSEMBLY

62. Remove the three (3) bolts attaching the brake dust shield to the factory steering knuckle. Save hardware.
63. Remove the four (4) hub bolts attaching the hub to the steering knuckle. Save hardware.
64. Transfer the hub assembly to the new steering knuckle using the factory bolts (Fig. 44). Use thread locker on the factory bolts. Torque the hub bolts to 129 ft-lbs.

**FIGURE 44**



65. Attach the dust shield to the steering knuckle with the factory dust shield bolts. Tighten to 120 in-lbs. (Fig. 45).

**FIGURE 45 - SHOWN ALREADY INSTALLED**



66. Attach the steering knuckle to the lower control arm using the factory nut while feeding the CV shaft through the hub. Tighten the lower ball joint nut to 76 ft-lbs.
67. Attach the steering knuckle to the upper control arm using the factory nut (Fig. 46). Tighten the upper ball joint nut to 46 ft-lbs.

**FIGURE 46**

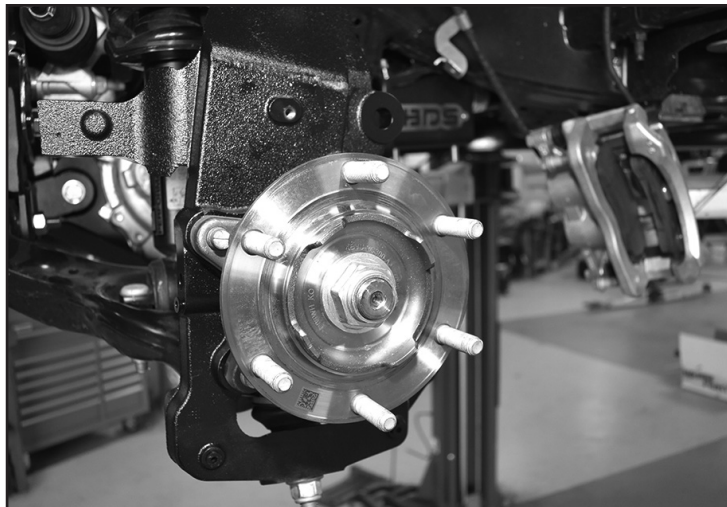


68. Fasten the CV axle to the hub assembly with the original nut/washer and torque to 221 ft-lbs (Fig. 47).



**Tip** *The CV shaft torque can be checked on the ground with the weight of the vehicle.*

**FIGURE 47**



69. Install the rotor to the hub assembly. Attach the caliper to the new steering knuckle with the original mounting hardware (Fig. 48 A & B). Torque bolts to 111 ft-lbs.

**FIGURE 48A**

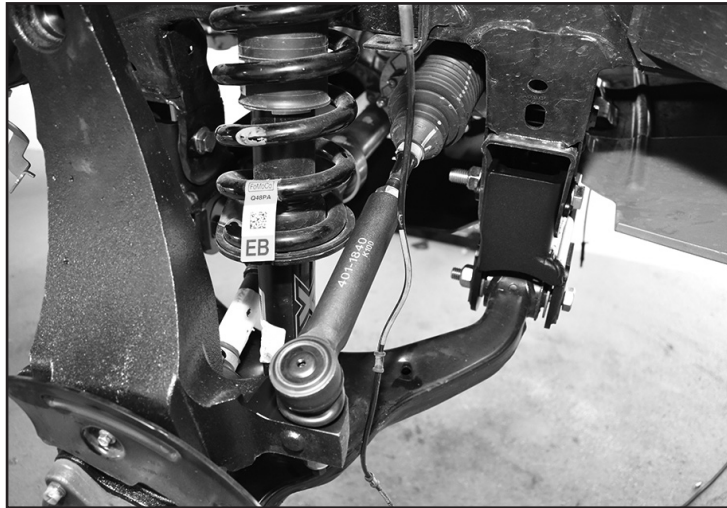


**FIGURE 48B**



70. Install the provided new outer tie rod to inner tie rod (Fig. 49). Leave about 3/4" of threads showing past the jam nut. Attach the outer tie rod to the knuckle from top down. Torque to 44 ft-lbs.

**FIGURE 49**

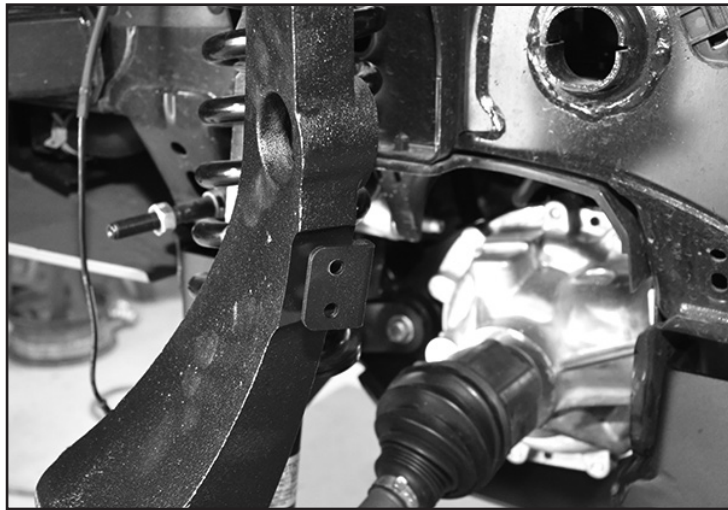


71. Install the brake line relocation bracket to the back side of the steering knuckle with the 6mm bolts and washer (Fig. 50).



**Tip** Hardware for the brake line bracket is located in bolt pack 859.

**FIGURE 50**

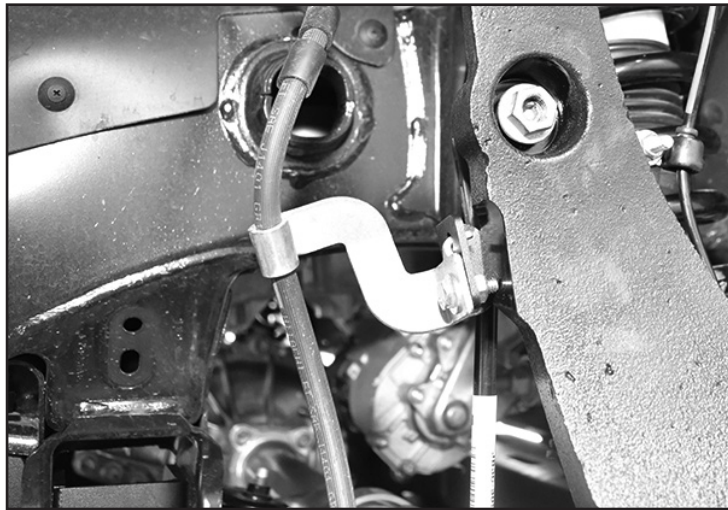


72. Attach the factory brake line bracket to the brake line relocation bracket with the provided 1/4" x 3/4" bolt, USS washer, and nylock nut (Fig. 51).



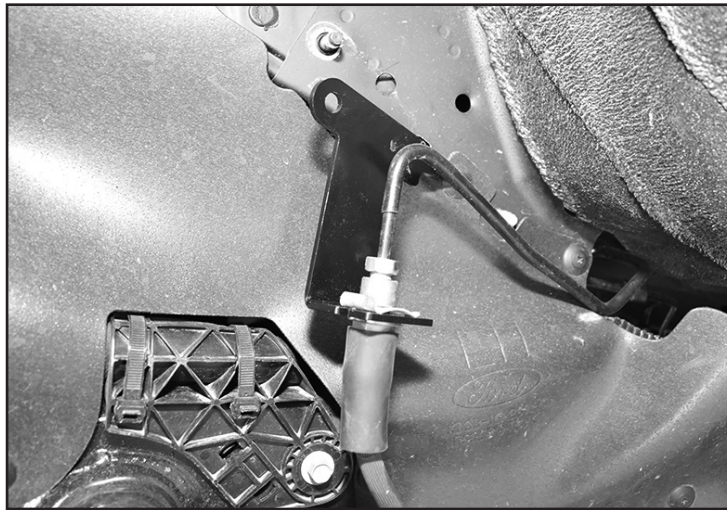
**Tip** Hardware for the factory brake line bracket is located in bolt pack 768.

**FIGURE 51**



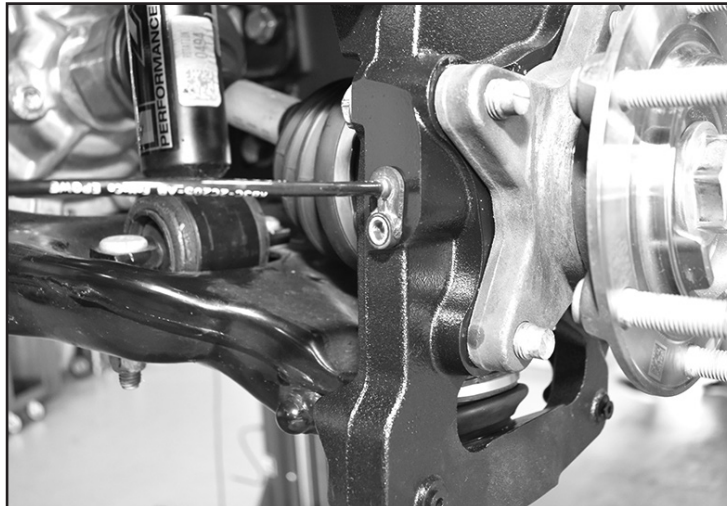
73. Install the brake line to the bracket using the factory clip removed earlier (Fig. 52). Install the new brake line bracket to the frame. Attach to the frame using the factory nut.

**FIGURE 52**




74. Attach the ABS sensor to the steering knuckle with the factory hardware (Fig. 53). Tighten the ABS sensor to 53 in-lbs.

**FIGURE 53**



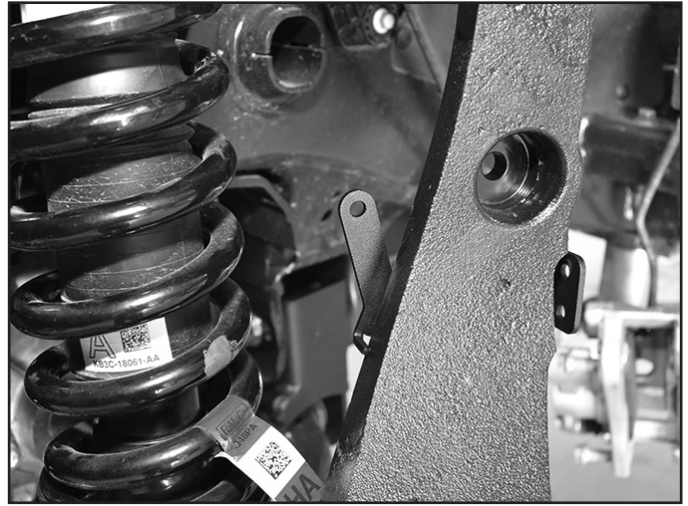
75. Use the provided wire clamps, 6mm bolt, washer, and thread locker to run the ABS wire up the back side of the steering arm underneath the tie rod (Fig. 54A). Torque bolt to 10 ft-lbs. Attach the ABS bracket to the back side of the steering knuckle using the 6mm bolt and washer. The brackets are side specific (Driver side bracket shown in Figure 54B). Attach the ABS sensor to the bracket using the 1/4" x 1" bolt, SAE washer, and nut with the wire clamp as shown in Figure 54C.

 **Tip** Hardware for the ABS line is located in bolt pack 859.

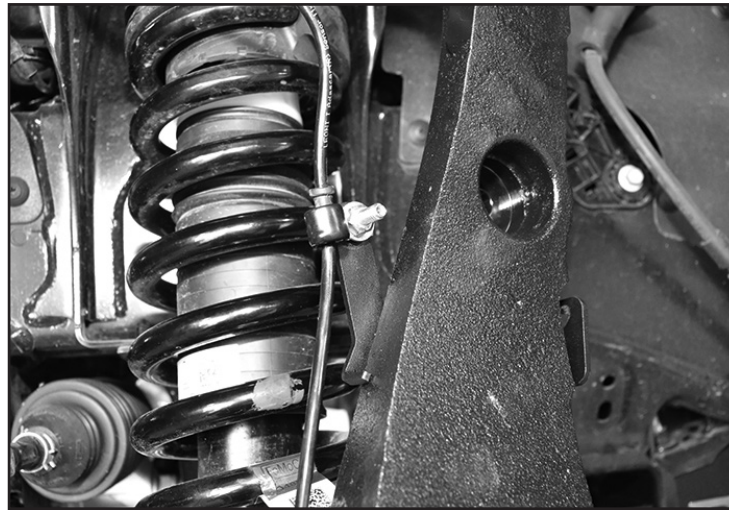
**FIGURE 54A**



**FIGURE 54B**



**FIGURE 54C**

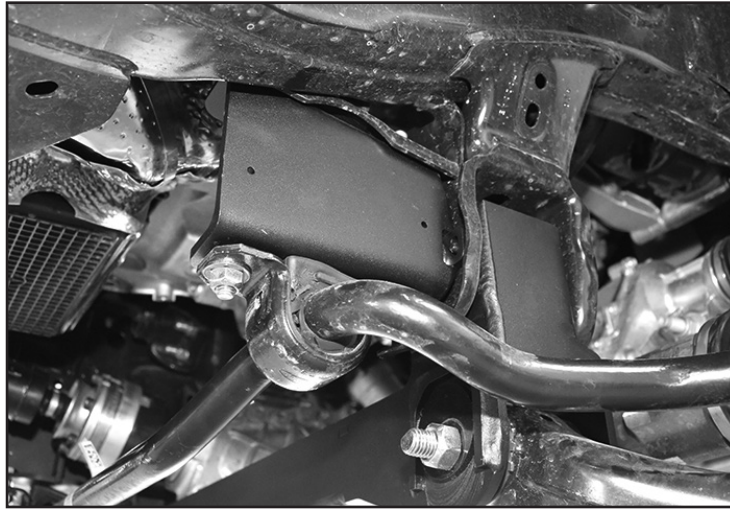


76. Attach the ABS line to the upper control arm with the a provided wide Christmas Tree wire clamps.
77. Attach the front sway bar to the sway bar drop brackets using the provided 7/16" washers and nuts to the bolts that were installed in the sway bar drop earlier (Fig. 55). Leave hardware loose.

 **Tip** Hardware for the sway bar drops is located in bolt pack 407.

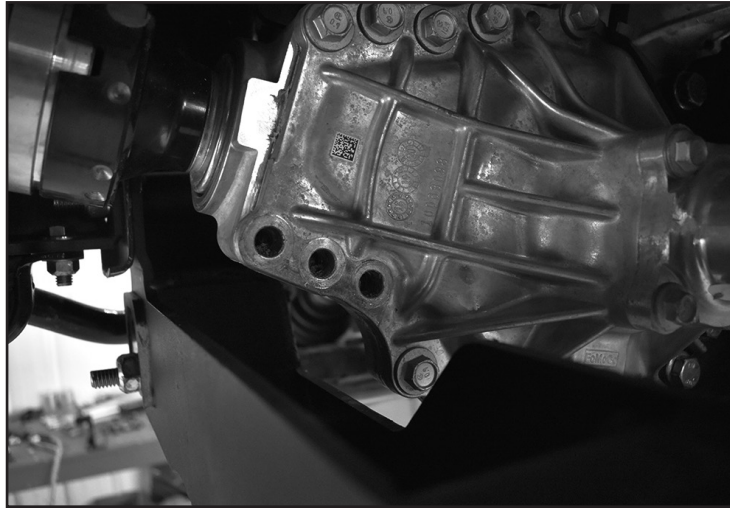


**FIGURE 55**



- 78. Attach the sway bar links to the steering knuckle with the factory nuts. Torque nuts to 85 ft-lbs.
- 79. Remove the 3 bolts on the front differential underneath the pinion. (Fig 56)

**FIGURE 56**



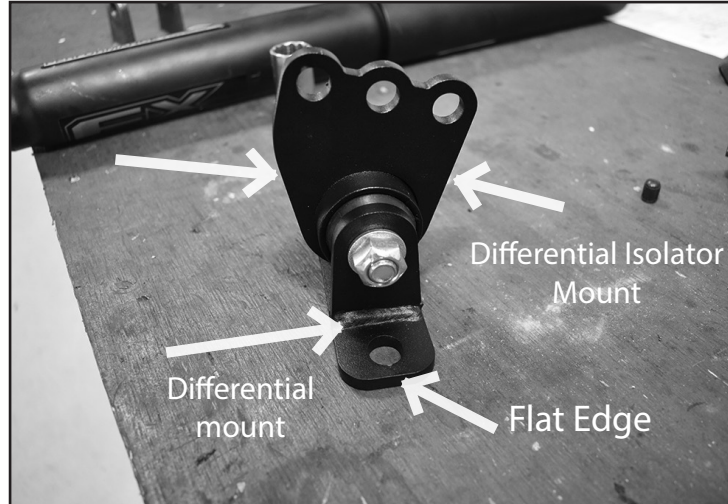
- 80. Install the bushing and sleeve into the differential isolator mount. (Fig 57)

**FIGURE 57**



81. Slide in the front differential mount onto the two 1/2" studs sticking up from the differential skid plate. The differential mount will install with the flat edge towards the center of the vehicle and the round edge towards the outside of the vehicle. Do not install the nuts at this time. (Fig 58)

**FIGURE 58**

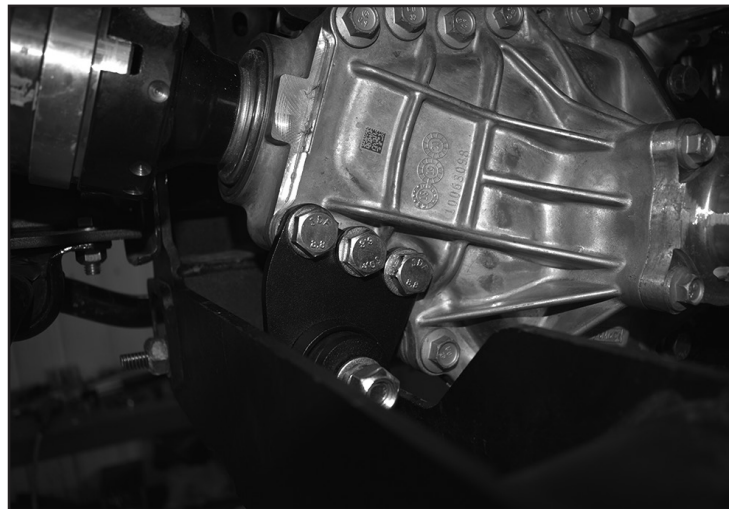


82. Loosely install the differential isolator mount to the differential with the new 12mm bolts and nuts using thread locker. The mount will install with the back edge as shown on the left in Figure 58 parallel with the cross member. Install the 12mm bolt, washers, and nut through the differential mount and the bushing in the isolator mount. (Fig 59)



**Tip** Hardware for the differential mount is located in bolt pack 868.

**FIGURE 59**



83. Install the 1/2" serrated edge nuts and thread locker onto the studs for the differential mount. Torque all differential mount hardware to 60 ft-lbs. (Fig 60)

**FIGURE 60**



84. Install the provided smaller BDS badge on each of the sway bar drop brackets using the provided 1/8" stainless steel rivets (Fig. 61).

**FIGURE 61**



85. Install the provided Larger BDS badge on each of the front cross member using the provided 3/16" stainless steel rivets (Fig. 62).

**FIGURE 62**



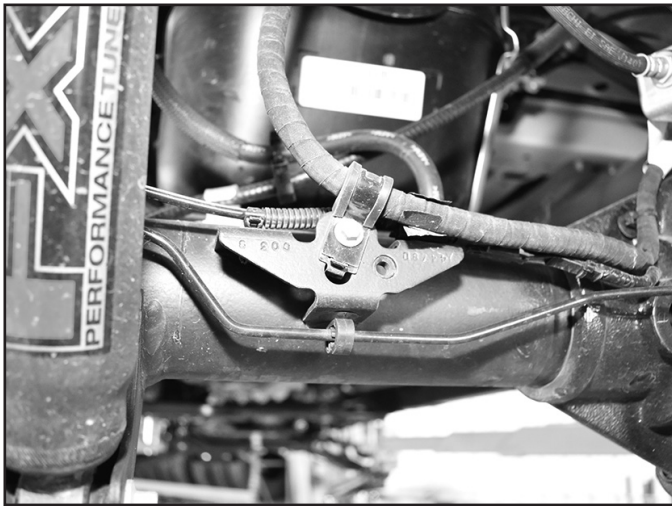
86. Install the wheels/tires and lower the front of the vehicle to the ground. Torque lug nuts to 100 ft-lbs.

87. Bounce the front of the vehicle to settle the suspension. Center the cams and torque the lower control arm mounting bolts to 180 ft-lbs. If the upper control arm cam bolts were loosened during the installation torque the bolts to 122 ft-lbs. Torque the sway bar drop hardware to 45 ft-lbs.
88. Check differential and CV shafts for clearance in all areas.
89. Check all hardware for proper torque.
90. If necessary, bleed the entire brake system. See service manual for proper brake system bleeding procedures.
91. Reconnect the battery cables to the battery. Reconnect the power steering control module connector

## REAR INSTALLATION

1. Block the front wheels. Safely raise the rear of the vehicle and support with jack stands just ahead of the front leaf spring frame mount.
2. Remove the wheels.
3. Support the rear axle with a floor jack.
4. Disconnect the rear brake line bracket from the top of the differential. Discard bolt.
5. Remove the ABS line (Fig. 63A) and the two E-brake cables bracket (Torx T40) (Fig. 63B DRV side shown) from the rear axle. Save bolts for later installation.

**FIGURE 63A**



**FIGURE 63B**



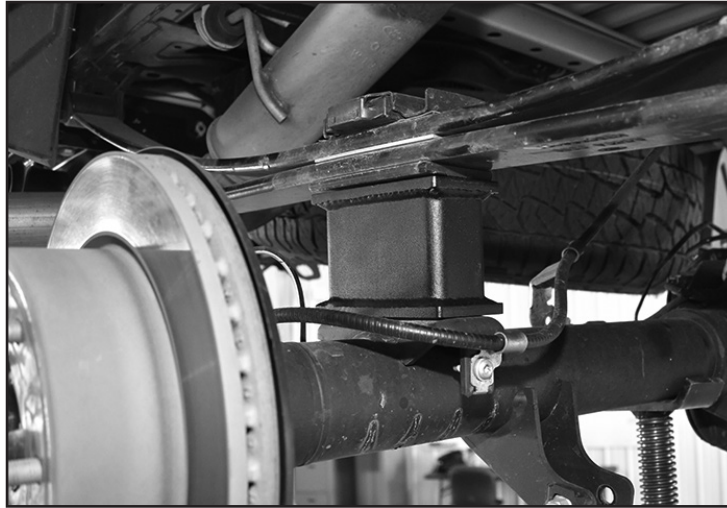
6. Support the center of the axle with a hydraulic jack. Remove the factory shocks from the axle and frame. Save hardware and discard shocks.
7. With the axle still well support remove the passenger's side U-bolts (Fig. 64). The U-bolts and nuts will not be reused. Save the lower U-bolt plate

**FIGURE 64**



- Lower the axle just enough to install the new provided lift block between the axle and the spring (Fig. 65). Align the pin in the block with the hole in the axle and the hole in the block with the leaf spring pin. It may be necessary to loosen the driver's side U-bolts slightly to allow the axle to lower far enough to install the block.

**FIGURE 65**

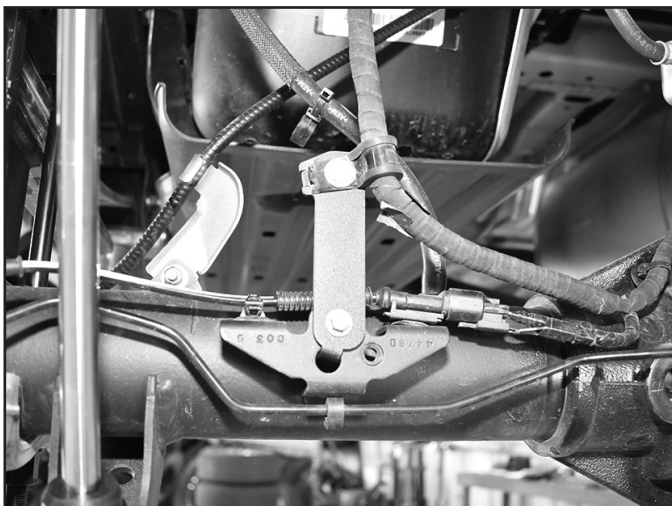


- Using the support jack, raise the axle so that the axle, spring and block are all touching. Install the new provided U-bolts, nuts and washers along with the factory U-bolt plate. Snug U-bolts but do not tighten.
- Repeat the installation on the driver's side of the vehicle. Pay special attention to all of the brake lines and wires. Do not allow them to get over-extended.
- Locate the new rear shocks. Install the provided bushings and steel sleeves into the eyes of the shocks. Lubricating the bushings and sleeves with some grease will make installation easier.
- Install the new shocks with stock hardware and torque upper and lower bolts to 52 ft-lbs.
- Install the Driver side ABS relocation bracket to the frame with the factory bolt. The alignment tab will line up with the factory hole. Attach the ABS line to the relocation bracket with the provided 1/4"-3/4" bolt, washers, and nut. (Fig. 61A). Install the Driver side E-brake cable relocation bracket to the frame with the factory bolt. The alignment tab will line up with the factory hole. Attach the E-brake cable to the relocation bracket with the provided 5/16"-3/4" bolt, washers, and nut. (Fig. 66B). Install the Passenger side E-brake cable relocation bracket to the frame with the factory bolt. The bracket will offset forward on the truck. The alignment tab will line up with the factory hole. Attach the E-brake cable to the relocation bracket with the provided 5/16"-3/4" bolt, washers, and nut. (Fig. 66C).

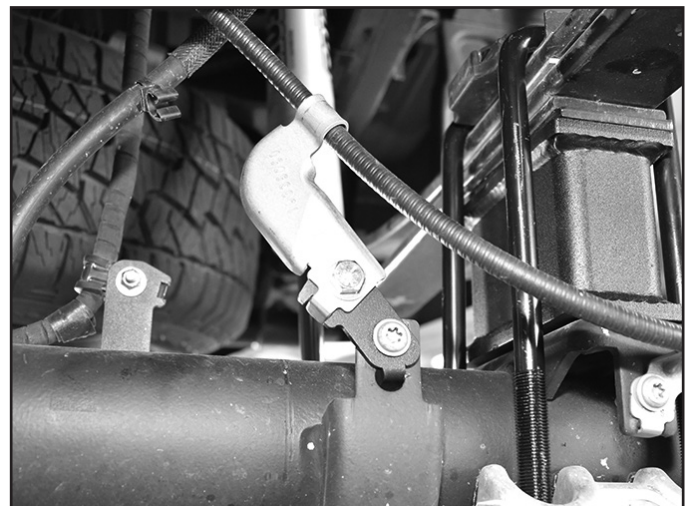


**Tip** Hardware for the E-brake and ABS relocation brackets is located in bolt pack 865.

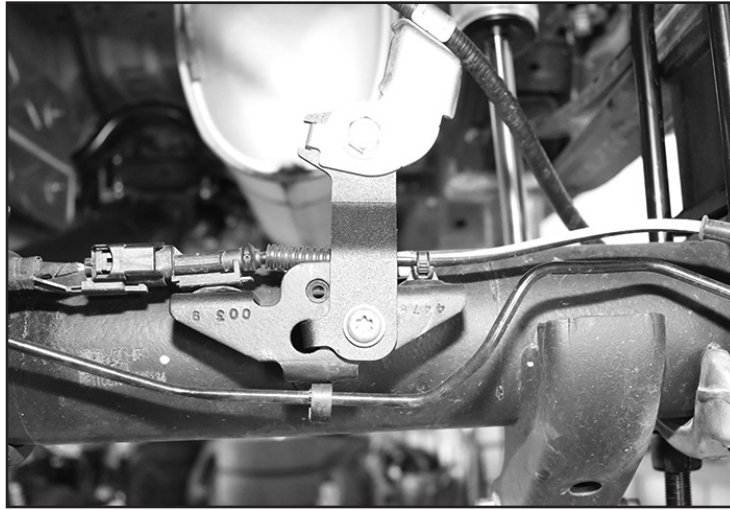
**FIGURE 66A**




**FIGURE 66B**



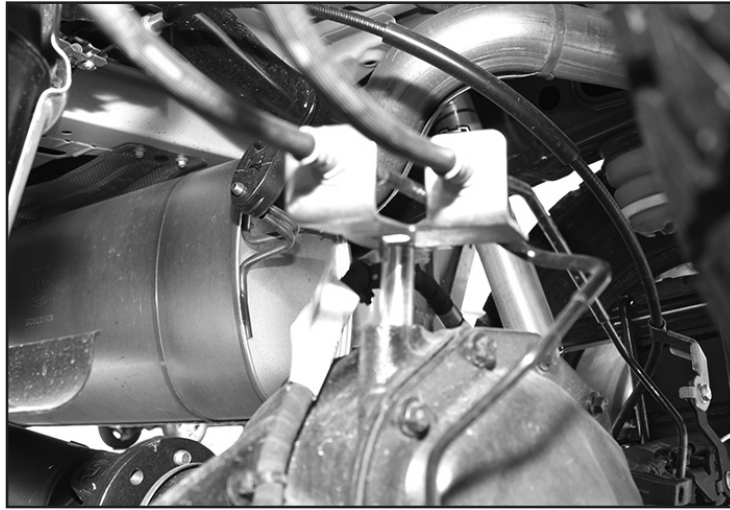
**FIGURE 66C**



14. Install the spacer tube for the rear brake line bracket between the bracket and the top of the differential. Use the provided 8mm x 55mm bolt and 5/16" SAE Washer (Fig. 67). Tighten the 8mm bolt to 15 ft-lbs.

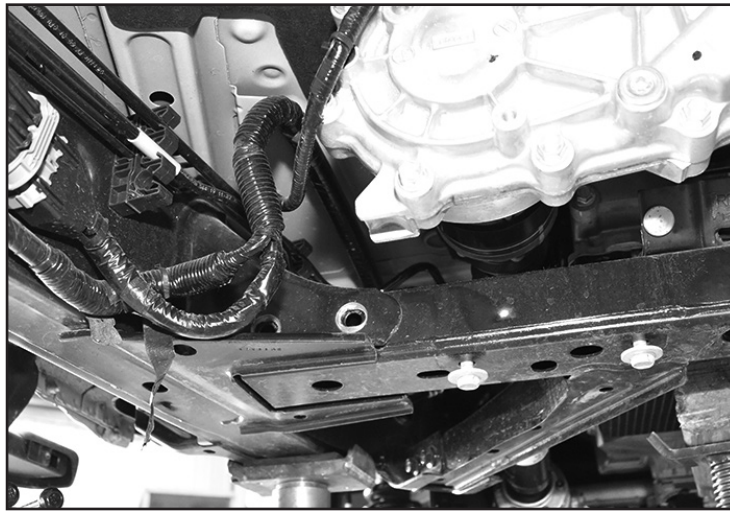
 **Tip** Hardware for the brake line bracket is located in bolt pack 865.

**FIGURE 67**



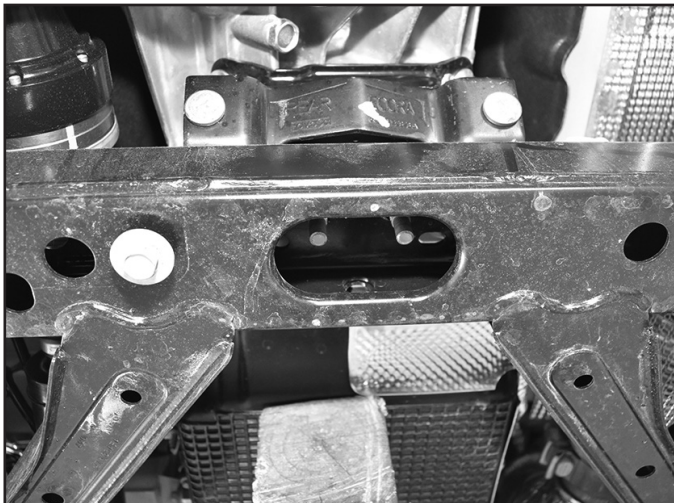
15. Remove the transfer case skid plate (Fig. 68). Save the two bolts on the frame rail and discard the two bolts going into the transfer case cross member.

**FIGURE 68**

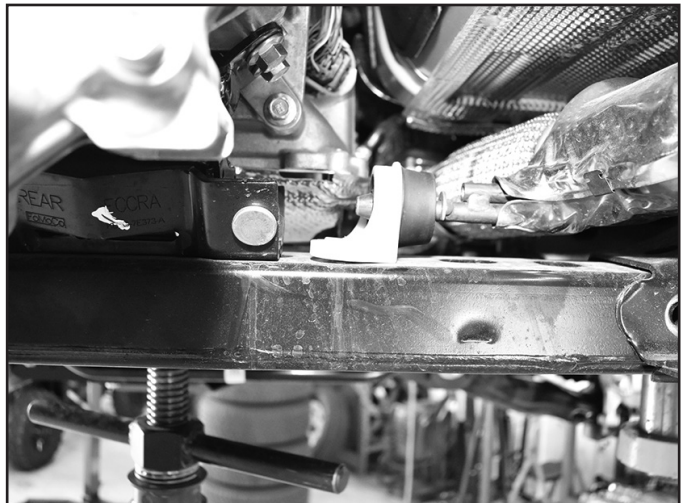


16. Remove the two nuts attaching the transfer case mount to the cross member (Fig. 69A). Support the transmission to take the load off of the transfer case mount in order to remove the cross member. Remove the exhaust hanger bolt from the cross member (Fig. 69B).

**FIGURE 69A**



**FIGURE 69B**



17. Remove the eight bolts and nuts attaching the transfer case cross member to the vehicle (Fig. 70 A & B). Remove the cross member from the vehicle. The cross member is a tight fit and will need to be pried / pounded out of the mounts.

**FIGURE 70A**



**FIGURE 70B**



18. Install the two new cross member braces to the new transfer case cross member with the provided 7/16" bolts, washer, and serrated edge nuts (Fig. 71). Snug up hardware, but do not tighten.

 **Tip** Hardware for the cross member braces is located in bolt pack 865.

**FIGURE 71**




19. Install the new transfer case cross member into the truck with the factory hardware. Tighten the 7/16" hardware for the braces to 45 ft-lbs then tighten the factory transfer case cross member hardware to 55 ft-lbs. Tighten the two forward braces with the factory hardware to 40 ft-lbs.
20. Lower the transfer case onto to new transfer case cross member and attach to the cross member with the factory nuts (Fig. 72). Tighten the nuts to 66 ft-lbs.

**FIGURE 72**



21. Attach the exhaust hanger to the transfer case crossmember with the provided 5/16" x 1" bolt, washer and serrated edge nut (Fig. 73A). Run the bolt from the top down. Tighten bolt to 12 ft-lbs. Attach the transfer case skid plate to the frame using the factory hardware. Leave loose. Attach the skid plate to the transfer case cross member with the two provided 3/8" x 1" bolt, washer, and serrated edge nut (Fig. 73B). Tighten all skid plate hardware to 25 ft-lbs.

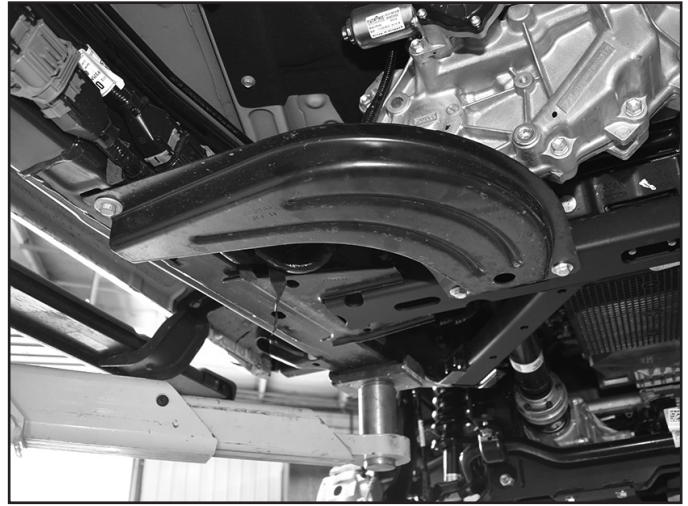
 **Tip** Hardware for the exhaust hanger and transfer case skid plate is located in bolt pack 865.



**FIGURE 73A**



**FIGURE 73B**



22. Remove the two factory bolts attaching the carrier bearing to the truck. Support the drive shaft so that it does not fall during the carrier bearing drop installation.
23. Install the carrier bearing drop to the frame with the provided 10mm bolts and 3/8" USS washer and using thread locker. The carrier bearing will install with the tall side towards the rear of the truck so that it is tapered to align the drive shaft with the carrier bearing. Torque the 10mm bolts to 35 ft-lbs.



**Tip** Hardware for the carrier bearing drop is located in bolt pack 865.

24. Attach the carrier bearing to the carrier bearing drop using the provided 10mm bolts and 3/8" "Thick" washers on the bottom side / carrier bearing side and the 3/8" USS washer and nut on the carrier bearing drop side (Fig. 74). Torque the 10mm bolts to 35 ft-lbs.

**FIGURE 74**



25. Install wheels and tires. Torque lug nuts to 100 ft-lbs. Lower vehicle.
26. Bounce the rear of the vehicle to settle the suspension. Torque leaf spring U-bolts to 100-120 ft-lbs.

## POST INSTALLATION

27. Double check all fasteners for proper torque.
28. Check all moving parts for clearance.
29. Complete a full radius turning check to ensure that no interference occurs.
30. Align headlights
31. Double check the brake lines for adequate slack at full wheel travel.
32. Complete a vehicle alignment.

33. Check all fasteners after 500 miles.



## **WE WANT TO SEE YOUR RIDE!**

Grab photos of your BDS-equipped truck in action and send them in for a chance to be featured. Send it in to our Bad Ass Rides customer gallery at [bds-suspension.com/bar](http://bds-suspension.com/bar) and post them on the BDS Fan Page on Facebook at [facebook.com/BDSSuspensions](https://facebook.com/BDSSuspensions). Don't forget about your BDS swag! BDS offers t-shirts, hoodies, decals and more available on the BDS website or through your local BDS distributor.

---

## **TIME TO HAVE SOME FUN**

### **Thank you for choosing BDS Suspension.**

For questions, technical support and warranty issues relating to this BDS Suspension product, please contact your distributor/installer before contacting BDS Suspension directly.