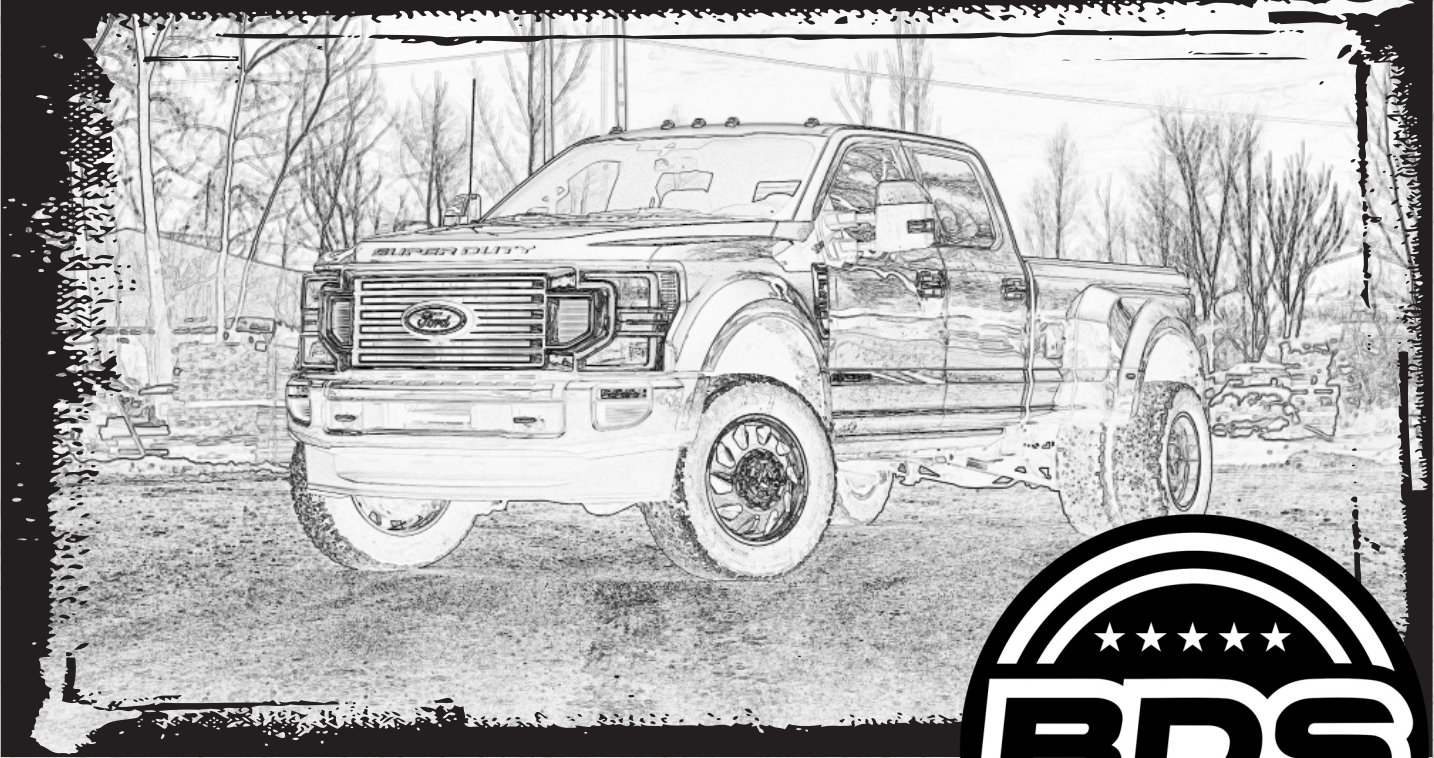


INSTALLATION GUIDE



Part#: 013263



HARDCORE LIMITED LIFETIME WARRANTY

Ford Super Duty 2.5" Radius Arm Kit

Ford F-450 | 2020-2022

Rev.052623

491 W. Garfield Ave., Coldwater, MI 49036 • Phone: 517-279-2135
Web: www.bds-suspension.com • E-mail: tech-bds@ridefox.com

Read And Understand All Instructions And Warnings Prior To Installation Of System And Operation Of Vehicle.



THANK YOU

Your truck is about to be fitted with the best suspension system on the market today. That means you will be driving the baddest looking truck in the neighborhood, and you'll have the warranty to ensure that it stays that way for years to come. Thank you for choosing BDS Suspension!

BEFORE YOU START

BDS Suspension Co. recommends this system be installed by a professional technician. In addition to these instructions, professional knowledge of disassembly/ reassembly procedures and post installation checks must be known.

FOR YOUR SAFETY

Certain BDS Suspension products are intended to improve off-road performance. Modifying your vehicle for off-road use may result in the vehicle handling differently than a factory equipped vehicle. Extreme care must be used to prevent loss of control or vehicle rollover. Failure to drive your modified vehicle safely may result in serious injury or death. BDS Suspension Co. does not recommend the combined use of suspension lifts, body lifts, or other lifting devices. You should never operate your modified vehicle under the influence of alcohol or drugs. Always drive your modified vehicle at reduced speeds to ensure your ability to control your vehicle under all driving conditions. Always wear your seat belt.

BEFORE INSTALLATION

- Special literature required: OE Service Manual for model/year of vehicle. Refer to manual for proper disassembly/reassembly procedures of OE and related components.
- Adhere to recommendations when replacement fasteners, retainers and keepers are called out in the OE manual.
- Larger rim and tire combinations may increase leverage on suspension, steering, and related components. When selecting combinations larger than OE, consider the additional stress you could be inducing on the OE and related components.
- Post suspension system vehicles may experience drive line vibrations. Angles may require tuning, slider on shaft may require replacement, shafts may need to be lengthened or trued, and U-joints may need to be replaced.
- Secure and properly block vehicle prior to installation of BDS Suspension components. Always wear safety glasses when using power tools.
- If installation is to be performed without a hoist, BDS Suspension Co. recommends rear alterations first.
- Due to payload options and initial ride height variances, the amount of lift is a base figure. Final ride height dimensions may vary in accordance to original vehicle attitude. Always measure the attitude prior to beginning installation.



Visit 560plus.com for more information.

TIRES AND WHEELS

Tire Size: 35x12.50

Wheel size: 20x8.25

	Offset	Backspace
Front	105mm	8.76"
Rear Outer	-202mm	-3.33"
Rear Inner	114mm	9.11"



BEFORE YOU DRIVE

Check all fasteners for proper torque. Check to ensure for adequate clearance between all rotating, mobile, fixed, and heated members. Verify clearance between exhaust and brake lines, fuel lines, fuel tank, floor boards and wiring harness. Check steering gear for clearance. Test and inspect brake system.

Perform steering sweep to ensure front brake hoses have adequate slack and do not contact any rotating, mobile or heated members. Inspect rear brake hoses at full extension for adequate slack. Failure to perform hose check/ replacement may result in component failure. Longer replacement hoses, if needed can be purchased from a local parts supplier.

Perform head light check and adjustment.

Re-torque all fasteners after 500 miles. Always inspect fasteners and components during routine servicing.

CONTENTS OF YOUR KIT

BDS 033251 - 2.5" Coil Springs

Part #	Qty	Description
033251R	2	Coil Springs

Rear Kit BDS 013207 - 2" Block

Part #	Qty	Description
2FB18	2	2" Flat Block
583181900S	4	5/8" x 3-1/8" x 19" Semi-Round U-bolt
03975	2	Superduty Dually 3" Bumpstop Extension
422	1	Bolt Pack- Dually Bumpstop Extension
B1441	1	Bumpstop Badge Bag Kit
02802	2	BDS Badge
995	1	Bolt Pack
B1203	1	Bag Kit - Dually
N58FHB	8	5/8" Fine High Nut - Black
W58SB	8	5/8" Washer - Black
03428	1	E-Brake Relocation Bracket
03429	1	E- Brake Relocation Clamp Bracket
989	1	Bolt Pack

BDS 013263 - 2.5" Front Box Kit - Replacement Radius Arm

Part #	Qty	Description
B1403	1	Bag Kit - 2.5" w/ Rad Arm
422	1	Bolt Pack - Sway Bar Drop
696	1	Bolt Pack - Bump Stop & Brake Line
341	2	Bolt pack - ABS wire clamp
01253	1	Sway Bar Drop - DRV
01254	1	Sway Bar Drop - PASS
A230	1	Front Adjustable Trackbar
B1068	1	Bag Kit - Adjustable Trackbar
3535BK	2	Bushing - black
107	1	1.125 x .156 x 1.745 DOM Tube
516	1	1/4in - 28 Grease Zerk (#60105)
3196	2	3" Dia x 1-1/2" tall bump stop
02998	1	2017+ SD Brakeline Brkt - DRV
02999	1	2017+ SD Brakeline Brkt- Pass

BDS 123251 - Radius Arm Box Kit

Part #	Qty	Description
A241	1	Superduty Replacement Rad Arm - DRV
02799	1	Superduty Replacement Arm
868190	1	Rad Arm Bushing
97525A430	2	Stainless Rivet
02802	1	Stainless Radius Arm Logo Plate
A242	1	Superduty Replacement Rad Arm - Pass
02799	1	Superduty Replacement Arm
868190	1	Rad Arm Bushing
97525A430	2	Stainless Rivet
02802	1	Stainless Radius Arm Logo Plate
B1114	1	Bag Kit - Replacement Radius Arm
02421	4	Caster Cam Plates
02002ZP	2	M18-2.50 X 150mm Bolt
N18MPT	2	M18-2.50 Prevailing Torque Nut
W34SAE	4	Washer
099002	2	Zip Tie - Push In
099000	6	Zip Tie

TROUBLESHOOTING INFORMATION FOR YOUR VEHICLE

1. Larger tires on stock wheels are not recommended due to brakeline clearance required. Use recommended specifications listed in tire and wheel fitment section.
2. Trackbar mounting bolt requires 405 ft-lbs of torque, plan ahead on how to achieve this.
3. Kit works on Gas model trucks. Gas models will achieve 1/2" more lift in the front.

**TECH
TIPS**

INSTALLATION INSTRUCTIONS

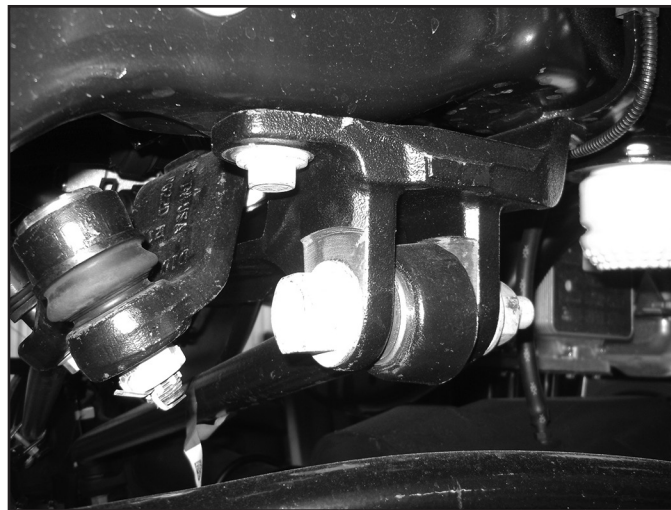
SPECIAL TOOLS

30mm (1-3/16") Socket
Small Pitman Arm Puller

INSTALLATION INSTRUCTIONS

1. Park the vehicle on a clean, flat surface and block the rear wheels for safety.
2. Disconnect the track bar from the frame bracket. Retain OE hardware. It is easiest to disconnect the track bar before the vehicle is lifted in the air. (Fig 1) Remove the track bar from the axle end. This can be done by removing the ball joint nut at the axle. Reinstall the nut a couple of turns to prevent damage to OE track bar joint threads. Use appropriate puller (small pitman arm puller works in most cases) to dislodge the taper from the axle bracket.
3. Remove the stock track bar. Retain all hardware.

FIGURE 1



4. Raise the front of the vehicle and support under the frame rails with jack stands.



Tip

As a result of the location of the long radius arm suspension, support locations are limited. Use your best judgment while supporting the vehicle with sufficient strength stands at appropriate locations. The radius arms will need to move freely during this installation.

5. Remove the front wheels.
6. Support the front axle with a hydraulic jack. With the axle supported this installation can be performed on both sides at the same time.

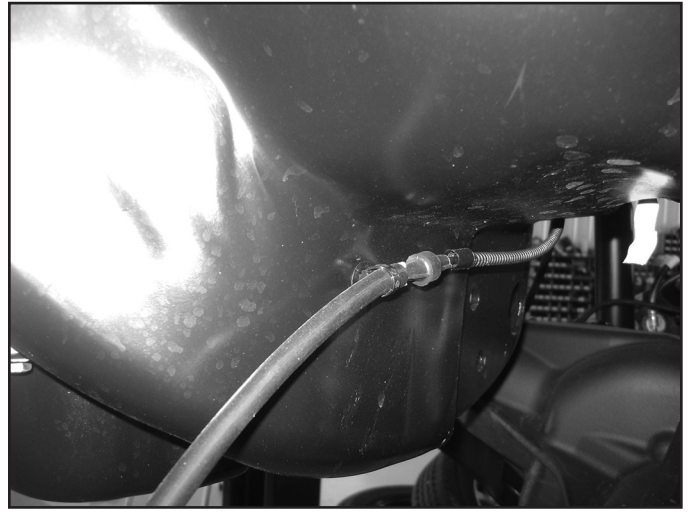
FRONT DISASSEMBLY:

7. Remove the vacuum line from the top of the radius arm on the driver's side (Fig 2a). Remove the vacuum line from the engine crossmember (Fig 2b).

FIGURE 2A



FIGURE 2B



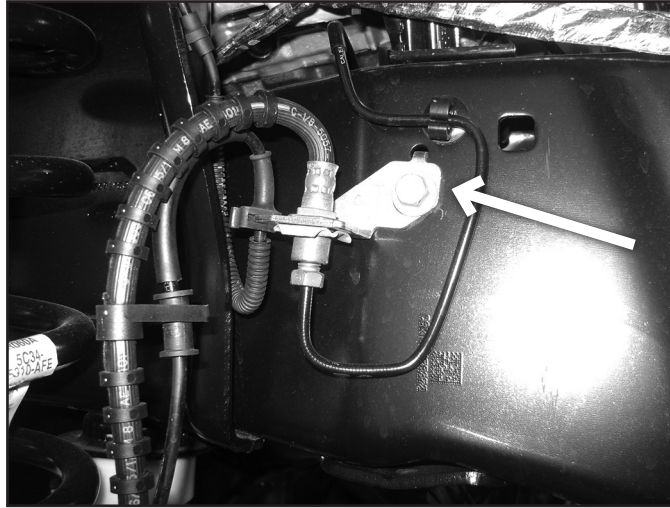
8. Remove the brake line bracket from the lower coil seat. Retain hardware. (Fig 3)

FIGURE 3



9. Disconnect the brake line bracket on frame (Fig 4). Retain hardware.

FIGURE 4



10. Carefully cut the factory bracket so that the brake line can be removed without breaking loose the fittings. Remove the factory brake lines from vehicle. Do not damage the brake line! (Fig. 5)

FIGURE 5

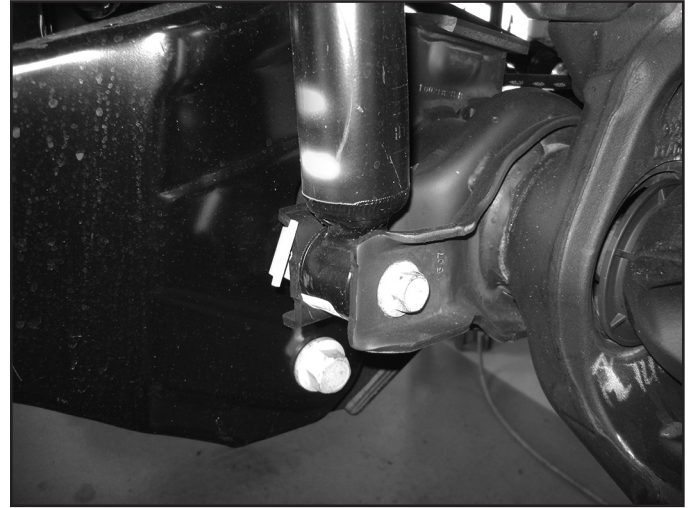


11. Disconnect the shocks by removing factory hardware (Fig 6a, 6b). Retain lower bolt and nut tab for later reinstallation.

FIGURE 6A

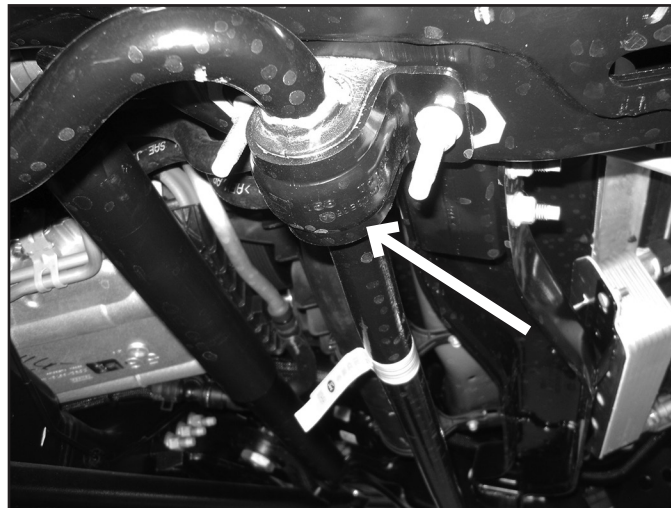


FIGURE 6B



12. Disconnect sway bar from the frame on both the driver and passenger side. Retain (4) mounting nuts. (Fig 7)

FIGURE 7



13. Lower the axle and remove the factory coil springs.

14. With coil springs out of the way, remove the factory bump stops (Fig. 8a), then remove the cup from the frame (Fig. 8b), discard hardware.

FIGURE 8A

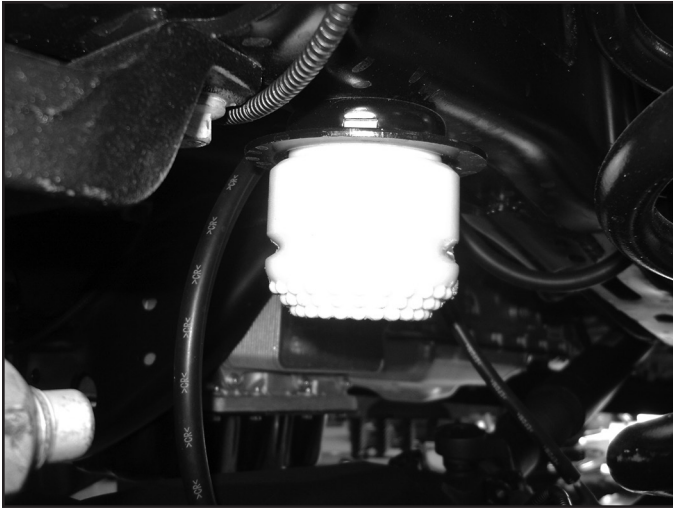


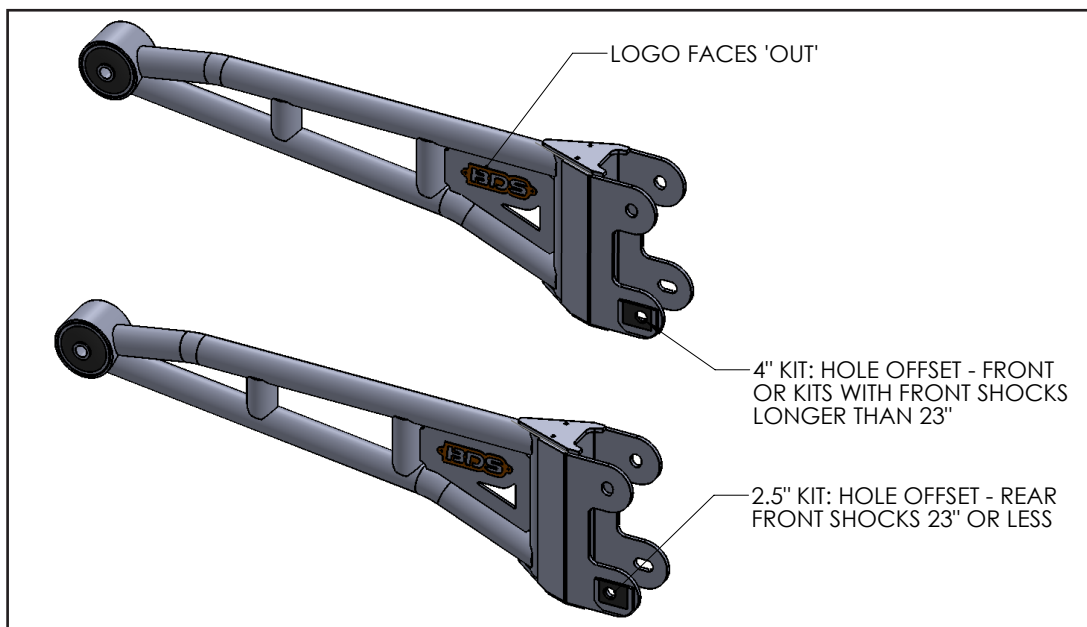
FIGURE 8B



RADIUS ARM INSTALLATION

15. Working on one side of the vehicle at a time, remove the stock radius arm and replace with the new one. Install cams into the lower slots with new 18mm hardware, and use new 18mm nut on the driver's side upper mount at the axle. The cam will be offset towards the rear of the vehicle as shown in the bottom image of Figure 9.

FIGURE 9



16. Tighten the radius arm hardware at the axle to 222 ft-lbs. Do not tighten the pivot bushing at the frame.

BUMP STOP INSTALLATION

17. Trim off the round edge 1-1/2" from the hole center to have a flat face and coat with paint (Fig. 10). This will give extra clearance between the coil spring and cup with the increased wheel travel the kit provides.

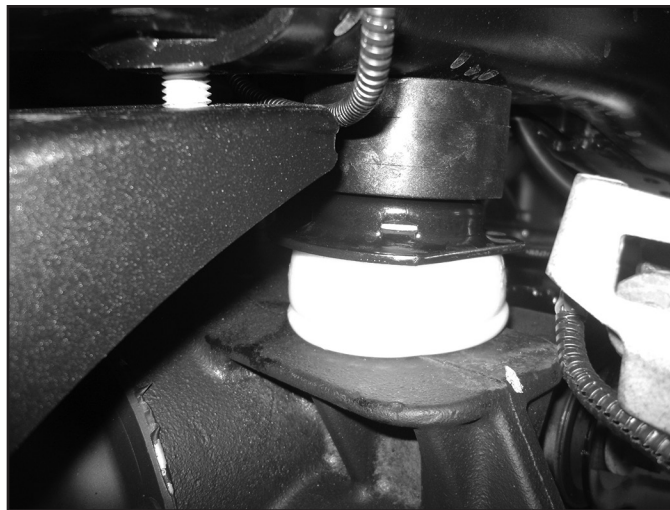
18. Install the 1-1/2" bump stop spacer with bump stop cup and 8mm hardware (BP #696). Rotate the bump stop cup so that the newly cut edge is flush with the frame. Note: If installing optional Fox coilovers, the 2" tall bump stop spacer that comes with the coilover mounting brackets will need to be installed. (Fig 10)

FIGURE 10



19. Grease the bump stops and reinstall into the factory cups. (Fig 11)

FIGURE 11



COIL AND SHOCK INSTALLATION

20. If optional coilovers are going to be installed, reference the coilover bracket instruction sheet included with the bracket kit at this time.
21. Grease and install sleeves and bushings into the shocks.

22. BDS (Silver / non-Fox) shocks will require the lower mount to be modified. The sharp, non-formed edge will need to be ground to match the formed profile. Grind this and coat with paint. (Fig 12, 13)

FIGURE 12

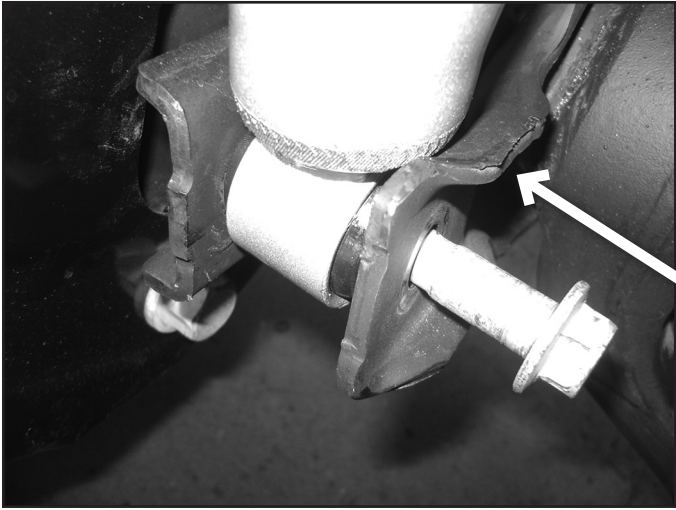
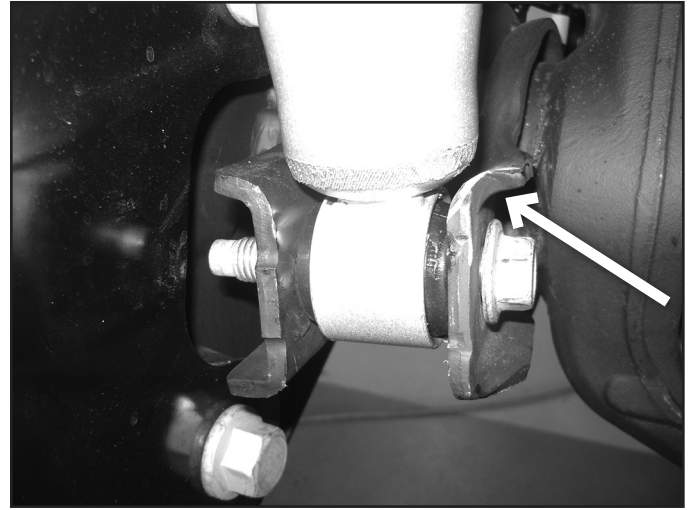


FIGURE 13



23. Compress the coils slightly by using a hydraulic jack on the axle. Install new shocks with factory lower hardware and stem washers, bushings, and 1/2" fine thread nut on the upper mount. Tighten the upper mount until the bushings begin to swell. Tighten lower mount to 50 ft-lbs.
24. Reattach all vacuum lines at axle and engine cross member with OE clips. Reattach vacuum line at driver's side radius arm with the included christmas tree zip tie. Reattach the brake line brackets at the lower coil spring seats with OE hardware. Fox coilovers will have the brackets attach to the lower mounting bracket with included hardware.

ADJUSTABLE TRACK BAR INSTALLATION

25. Grease and install bushings and sleeves into track bar. Thread grease zerk into track bar.
26. Adjust the track bar length (eye to eye) to 37 3/8" for 2.5" lift.
27. Install the track bar into the vehicle with the grease fitting facing down at the frame mount with the OE bolt. Leave hardware loose at this time.

BRAKELINE / SWAY BAR BRACKET INSTALLATION

28. Install the new brake line brackets, brackets are side specific. Brake lines will need to be reformed to reach new mounting position. It may be necessary to slightly twist the brake line fittings in relation to the hardline to get adequate clearance to the frame/ wheel and tire. Attach the ABS wire to the driver's side with 1/4" hardware and rubber coated cable clamp (Fig 15a, 15b)

FIGURE 15A - DRIVER'S

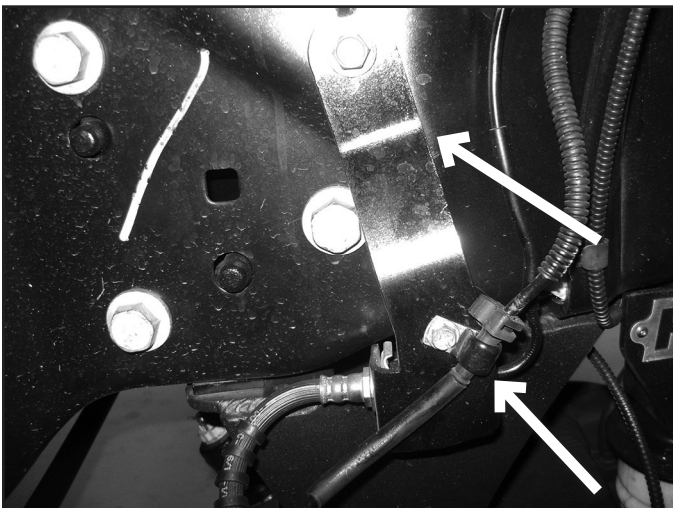
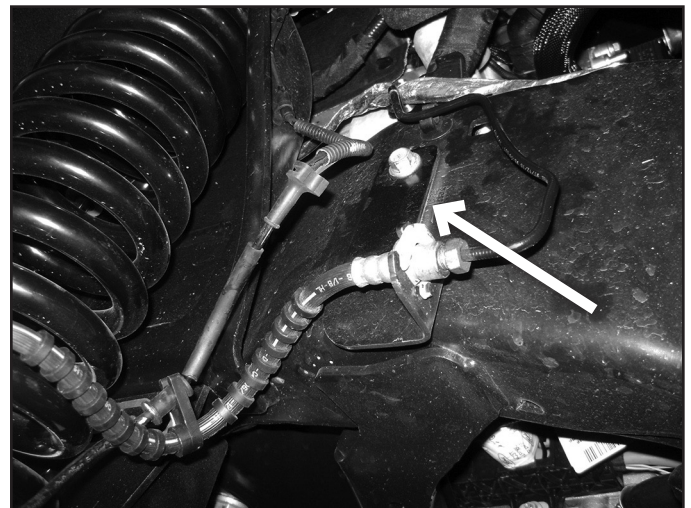


FIGURE 15B - PASSENGER'S



29. Install new sway bar drop brackets with factory nuts. Slide the brackets as far forward on the vehicle and tighten to 35 ft-lbs. (Fig. 16)

30. Attach sway bar to the drop bracket with 3/8" hardware (BP #422). Check for sway bar to lower coil mount clearance. Adjust forward / rearward as necessary to have adequate clearance. Tighten to 35 ft-lbs. (Fig 16)

FIGURE 16



31. Reinstall wheels and lower vehicle to the ground.
32. Tighten radius arm pivot hardware at the frame to 222 ft-lbs.
33. Check for sway bar link clearance to lower coil mount. Adjust sway bar mounting to bracket if necessary.
34. Attach the axle mount to the track bar. It may be necessary to have an assistant turn the wheel to help get the mount lined up. Square the mount up to the factory joint. Attach with factory nut. Tighten to 184 ft-lbs.
35. Tighten OE track bar hardware at frame side, torque to 405 ft-lbs.
36. Ensure the axle is centered under the vehicle. Additional adjustment of the track bar collar may be required. Do not extend past 37-5/8" eye-eye measurement due to maximum length of the factory drag link.
37. Remove (4) allen bolts and apply thread locker to threads, then reinstall into track bar.
38. First tighten pinch bolts on the track bar left-to-right at 30 ft-lbs.
39. Repeat left-to-right sequence at 30 ft-lbs until all pinch bolts meet 30 ft-lbs specification.
40. Check the track bar collar to frame crossmember for adequate clearance. A small amount of grinding on the frame cross member lip may be required for clearance to the track bar under compression clearance. (Fig 17)

FIGURE 17



41. Adjust steering wheel to center, this will require lengthening of the drag link. Do not drive the vehicle with the steering wheel off-center for extended distances / speeds or a trip to the dealership may be required to reset the computer. Note: if there is less than 1-3/4" of thread engaged in the adjusting collar, the track bar must be shortened to allow for adequate thread engagement of the drag link.
42. Adjust the clamps on the drag link so that they will not hit the sway bar through wheel travel or steering range of motion.
43. Check hardware after 500 miles.

REAR INSTALLATION 2" BLOCK KIT

44. Block the front wheels for safety.
45. Raise the rear of the vehicle and support with jack stands under the frame rails just ahead of the spring hangers.
46. Remove the wheels.
47. Support the axle with a hydraulic jack.
48. Remove the factory shocks. Retain all mounting hardware.
49. Disconnect the passenger's side spring u-bolts. (Fig 18)

FIGURE 18



50. Remove the factory lift block. It will not be reused.
51. Lower the axle enough to place the provided 2" lift block between the axle and leaf spring.
52. Raise the axle to engage the block-spring alignment pin. Fasten the entire assembly with the provided u-bolts, high nuts and washers. Snug but do not torque u-bolts at this time.
53. Repeat block installation of the driver's side. Take care not to over extend the brake lines.

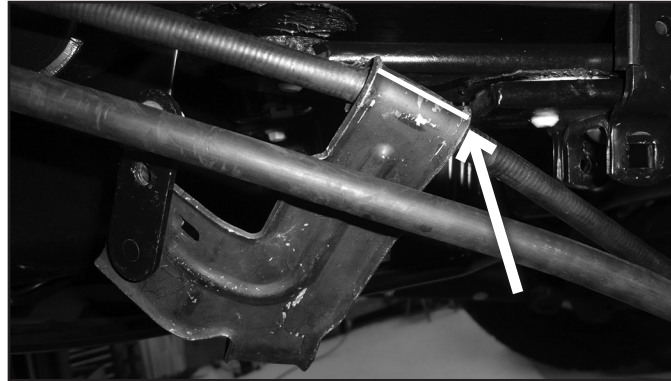
OPTIONAL- E-BRAKE CABLE RELOCATION

If installing aggressive offset wheels and/or wide tires that may interfere with the e-brake cables, relocation brackets included in this kit may be installed.

54. Remove the cable from the rear-most retaining bracket on the frame.
55. Gain slack from the E-Brake cable on the driver's side. It is easiest to pull on the cable and use a pair of vise grips to hold the cable, be careful not to damage the cable.

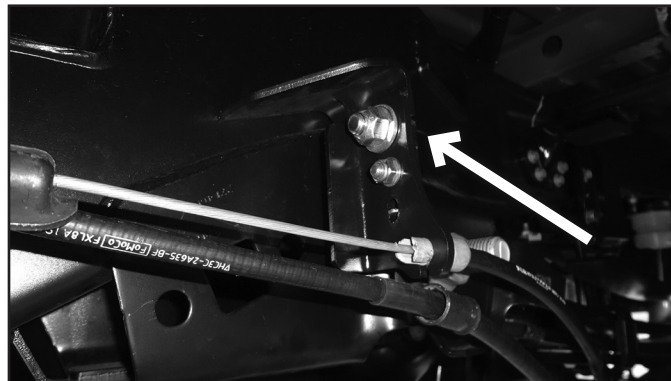
56. Cut the bracket for the E-brake cable that is going to the passenger side of the vehicle in order to release the cable from the bracket. See Figure 19 for which bracket and where to cut. It is easiest to cut most of the way through the steel and then bend the flange up to release the cable from the bracket. Be careful not to cut the E-brake cable!

FIGURE 19



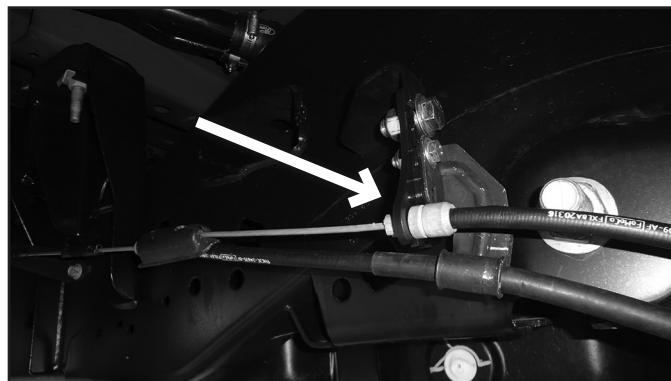
57. Depress the tabs and remove the passenger side E-brake cable from the mount on the frame.
58. Once the passenger side E-brake cable is free, remove the bolt and J-nut attaching the bracket to the frame.
59. Remove the driver side E-brake cable from the bracket and discard the bracket and hardware.
60. Remove the bolt and J-nut for smaller E-brake cable bracket.
61. Install the new E-brake cable bracket with the provided 1/2" hardware and 5/16" hardware from bolt pack 989 as shown in Figure 20. The smaller driver side E-brake cable bracket will be installed in the same position as it was from the factory, but attached with the 5/16" hardware (Figure 20).

FIGURE 20



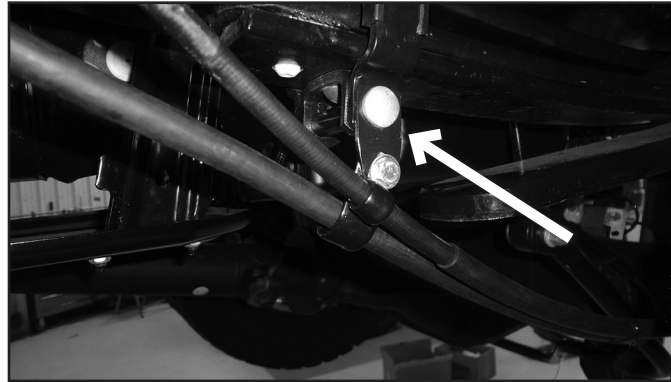
62. Install the passenger side E-brake cable into the bracket, make sure the tabs on the cable lock the cable into place (Figure 21).

FIGURE 21



63. Remove the 3/8" bolt on the front leaf springs clamp. Install the E-brake clamp bracket with the new provided 3/8" bolt and nut from bolt pack 989 through the leaf spring clamp. Make sure the E-brake clamp bracket is towards the outside of the leaf spring. Tighten the 3/8" hardware with the spacer tube in between to 25 ft-lbs. (Fig. 22)
64. Use the two provided wire clips from bolt pack 989 to secure both E-brake cables to the E-brake clamp bracket with the provided 5/16" hardware from bolt pack 989 (Figure 22).

FIGURE 22



65. Install the new shocks with the original mounting hardware. Torque to 55 ft-lbs.
66. Remove the two nuts attaching the rear bump stops to the frame.
67. Install the rear bump stop spacer to the frame with the factory hardware. Install the spacer such that the two small holes are to the outside of the frame.

Note: A 3/8" swivel socket will help to install the bump stop spacer to the frame.

68. Install the bump stop to the bump stop spacer using the 3/8" hardware provided in Bolt Pack 422.
69. Rivet the BDS badge to the bump stop spacer. Repeat bump stop spacer installation on both sides of the truck.
70. Install wheels and lower the vehicle to the ground.
71. With the weight of the vehicle on the axle, torque the u-bolts to 130-150 ft-lbs. The u-bolts can be trimmed now to the desired length.
72. Torque lug nuts to factory specification.
73. Recheck all hardware for proper torque, check again after 500 miles and at regularly scheduled maintenance intervals.



WE WANT TO SEE YOUR RIDE!

Grab photos of your BDS-equipped truck in action and send them in for a chance to be featured. Send it in to our Bad Ass Rides customer gallery at bds-suspension.com/bar and post them on the BDS Fan Page on Facebook at [facebook.com/BDSuspensions](https://facebook.com/BDSSuspensions). Don't forget about your BDS swag! BDS offers t-shirts, hoodies, decals and more available on the BDS website or through your local BDS distributor.

TIME TO HAVE SOME FUN

Thank you for choosing BDS Suspension.

For questions, technical support and warranty issues relating to this BDS Suspension product, please contact your distributor/installer before contacting BDS Suspension directly.