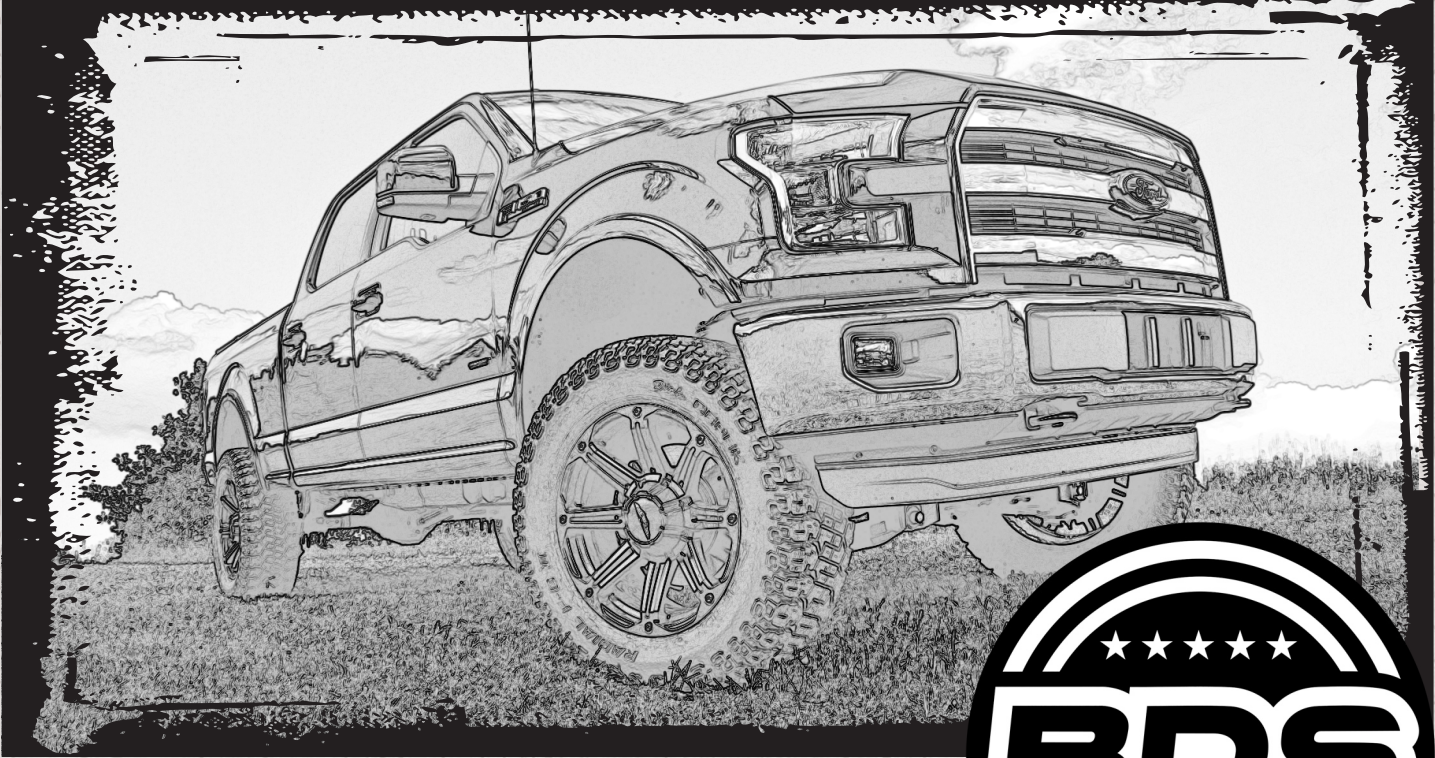


# INSTALLATION GUIDE



Part#: 023408



**HARDCORE LIMITED LIFETIME WARRANTY**

## 4" Suspension System

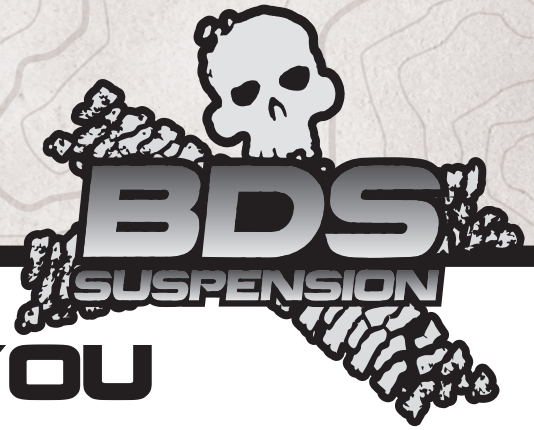
**Ford Raptor 4WD | 2017-2018**

Rev. 082823

491 W. Garfield Ave., Coldwater, MI 49036 • Phone: 517-279-2135

E-mail: [tech-bds@ridefox.com](mailto:tech-bds@ridefox.com)

# Read And Understand All Instructions And Warnings Prior To Installation Of System And Operation Of Vehicle.



## THANK YOU

Your truck is about to be fitted with the best suspension system on the market today. That means you will be driving the baddest looking truck in the neighborhood, and you'll have the warranty to ensure that it stays that way for years to come. Thank you for choosing BDS Suspension!

### BEFORE YOU START

BDS Suspension Co. recommends this system be installed by a professional technician. In addition to these instructions, professional knowledge of disassembly/ reassembly procedures and post installation checks must be known.

### FOR YOUR SAFETY

Certain BDS Suspension products are intended to improve off-road performance. Modifying your vehicle for off-road use may result in the vehicle handling differently than a factory equipped vehicle. Extreme care must be used to prevent loss of control or vehicle rollover. Failure to drive your modified vehicle safely may result in serious injury or death. BDS Suspension Co. does not recommend the combined use of suspension lifts, body lifts, or other lifting devices. You should never operate your modified vehicle under the influence of alcohol or drugs. Always drive your modified vehicle at reduced speeds to ensure your ability to control your vehicle under all driving conditions. Always wear your seat belt.

### BEFORE INSTALLATION

- Special literature required: OE Service Manual for model/year of vehicle. Refer to manual for proper disassembly/reassembly procedures of OE and related components.
- Adhere to recommendations when replacement fasteners, retainers and keepers are called out in the OE manual.
- Larger rim and tire combinations may increase leverage on suspension, steering, and related components. When selecting combinations larger than OE, consider the additional stress you could be inducing on the OE and related components.
- Post suspension system vehicles may experience drive line vibrations. Angles may require tuning, slider on shaft may require replacement, shafts may need to be lengthened or trued, and U-joints may need to be replaced.
- Secure and properly block vehicle prior to installation of BDS Suspension components. Always wear safety glasses when using power tools.
- If installation is to be performed without a hoist, BDS Suspension Co. recommends rear alterations first.
- Due to payload options and initial ride height variances, the amount of lift is a base figure. Final ride height dimensions may vary in accordance to original vehicle attitude. Always measure the attitude prior to beginning installation.

### BEFORE YOU DRIVE

Check all fasteners for proper torque. Check to ensure for adequate clearance between all rotating, mobile, fixed, and heated members. Verify clearance between exhaust and brake lines, fuel lines, fuel tank, floor boards and wiring harness. Check steering gear for clearance. Test and inspect brake system.



Visit [560plus.com](http://560plus.com) for more information.

### TRACTION CONTROL

In an effort to reduce the risk of rollover crashes the National Highway Traffic Safety Administration (NHTSA) established the Federal Motor Vehicle Safety Standard (FMVSS) No. 126 requiring all new passenger vehicles under 10,000 lbs GVWR include an electronic stability control (ESC) system as standard equipment. Effective August 2012 this law requires aftermarket products to be compliant with these same standards.



### TIRES AND WHEELS

#### FITMENT GUIDE

##### 4" Lift:

37x12.50 on 18x9 with 5" backspacing\*  
37x12.50 on 20x9 with 5.5" backspacing

\*See troubleshooting notes



Perform steering sweep to ensure front brake hoses have adequate slack and do not contact any rotating, mobile or heated members. Inspect rear brake hoses at full extension for adequate slack. Failure to perform hose check/ replacement may result in component failure. Longer replacement hoses, if needed can be purchased from a local parts supplier.

Perform head light check and adjustment.

Re-torque all fasteners after 500 miles. Always inspect fasteners and components during routine servicing.

# CONTENTS OF YOUR KIT

## BDS023408 Raptor Box Kit

Part #	Qty	Description
02427	2	4in Strut Spacer
03541	1	Raptor Skid Plate Relocation
03547	2	Raptor Rear Shock Relocation
75	4	1.25 x 5/16 x .50 DOM Sleeve
675	1	Bolt Pack - Front Skid Plates
	5	1/2"-13 x 1-1/4" bolt
	7	1/2" SAE Washer
	2	1/2"-13 Nylock Nut
	4	10mm-1.50 x 40mm bolt
	4	3/8" USS Washer
	1	3/8"-16 serrated edge flanged nut
46	2	.750 x .120 x 1.450 Rolled Sleeve
676	1	Bolt Pack - Rear Shock
	4	12mm ID thick washer
	4	12mm-1.75 x 80mm bolt
	8	12mm flat washer
	4	12mm-1.75 Prevailing torque nut
	2	3/8"-16 x 1-1/4" bolt
	2	3/8" SAE Thru hardened washer
	2	3/8"-16 serrated edge flanged nut
697	1	Bolt Pack - Rear Brake Lines
	1	5/16"-18 x 1-1/2" Bolt
	1	5/16" SAE Washer
	1	1/4" SAE Washer
	1	1/4"-20 Prevailing Torque Nut
04066	1	Spacer Sleeve - 0.625 x 0.095 x 0.813
B1067	1	Bag Kit
400408-10	1	Vent Hose
769	1	Bolt Pack - Strut Spacer
	6	7/16"-14 nylock nut
	6	3/8" USS flat washer
629	1	Bolt Pack - Strut Spacer
	6	10mm-1.50 prevailing torque nut
	6	3/8" USS flat washer

## BDS013539 Rear Box Kit

Part #	Qty	Description
02085	2	5" Rear Block
02086	2	Lower Spring Plate
02087	2	Upper Spring Plate
963181212QB	4	9/16 x 3-1/8 x 12-1/2 Square U-bolt
01716	1	Radiator Relocation Bracket
W96S-B	8	9/16 SAE Flat Washer
N96FH-B	8	9/16 Fine High Nut
465	1	Bolt Pack
120100FCP	2	1/2" Center Pin

## BDS023634 - Knuckle Box - Drv

Part #	Qty	Description
02805	1	Knuckle - Drv
02487	1	Ball Joint Washer

## BDS023635 Knuckle Box - Pass

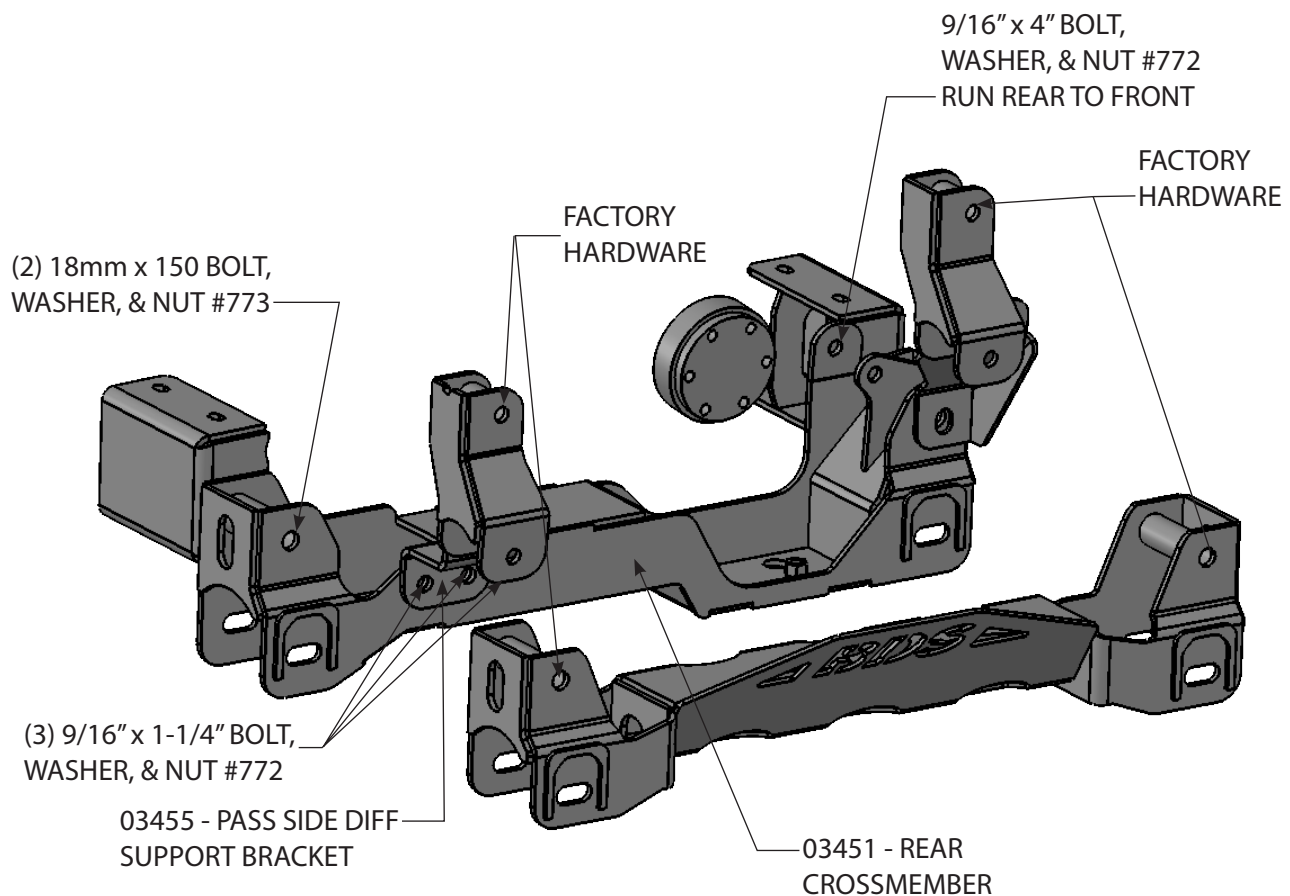
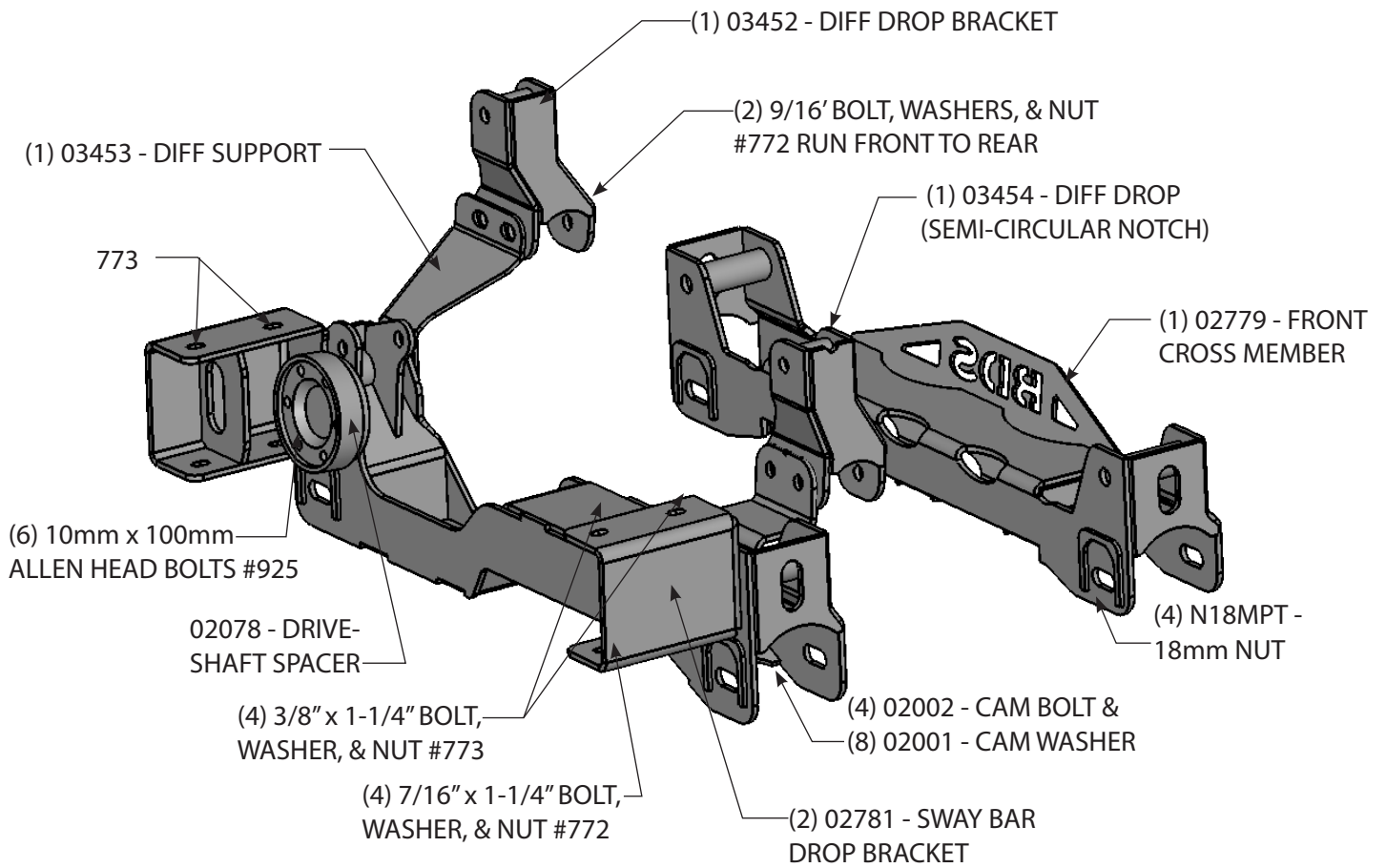
Part #	Qty	Description
02806	1	Knuckle - Pass
02487	1	Ball Joint Washer

## BDS023650 Front Box Kit 1 of 2

Part #	Qty	Description
02078	1	Driveshaft Spacer
02779	1	Front Crossmember
03451	1	Rear Crossmember
03453	1	Diff Support Bracket - Drv
02001	8	F150 Eccentric Cam
02002	4	F150 Eccentric Bolt
N18MPT	4	M18-2.5 prevailing torque nut
01602	2	Strap w/stud
925	1	Bolt Pack - Driveshaft Spacer
	6	10mm x 100mm Socket Head Cap Screw

## BDS023651 Front Box Kit 2 of 2

Part #	Qty	Description
03452	1	Diff Drop Bracket - Drv
03454	1	Diff Drop Bracket - Pass
03455	1	Diff Support Bracket - Pass
02803	1	Diff Skid Plate
02781	2	Sway Bar Drop
400408-10	1	5/16" x 10" Hose
772	1	Bolt Pack - Differential Drop
	3	9/16"-12 x 4" bolt
	5	9/16"-12 x 1-1/4" bolt
	16	9/16" flat washer
	8	9/16"-12 Prevailing torque nut
	4	7/16"-14 x 1-1/4" bolt
	8	7/16" SAE flat washer
	4	7/16"-14 prevailing torque nut
773	1	Bolt Pack
	2	18mm-2.50 x 150mm bolt
	4	3/4" SAE washer
	2	18mm-2.50 prevailing torque nut
	2	1/4"-20 prevailing torque nut
	4	1/4" USS flat washer
	2	6mm-1.00 x 18mm bolt
	4	1/2"-13 x 1-1/4" button head bolt
	4	1/2" SAE washer
	4	3/8"-16 x 1-1/4" bolt
	8	3/8" SAE flat washer
	4	3/8"-16 prevailing torque nut



# TECH TIPS

## TROUBLESHOOTING INFORMATION FOR YOUR VEHICLE

1. 18" wheels with 5-5.5" backsacing should be test fit prior to mounting the tire to ensure proper clearance to the steering knuckle/tie rod. 5.5" backsacing is highly recommended for tire to frame crash bar clearance.
2. 18" or larger diameter wheels required. Stock 17" and 18" wheels cannot be re-installed. Stock 20" wheels can be used with up to a 305/60R20 tire.
3. Models with 2-piece rear driveshaft WILL require carrier bearing shim kit 122405 (not included w/ kit)
4. Block kits replace factory block. Stock block will not be reinstalled.
5. Crash bars may require modification based on wheel and tire choice. It is the end users responsibility to ensure modifications are non-detrimental to vehicle safety.

## PRE INSTALLATION

### IMPORTANT

It is required that ride height measurements be taken before and after installation. Measure from the **WHEEL AXLE CENTER** up to the **FENDER LIP** of the wheel opening. Do this for all 4 wheels. Record measurements below.\*\*

#### BEFORE

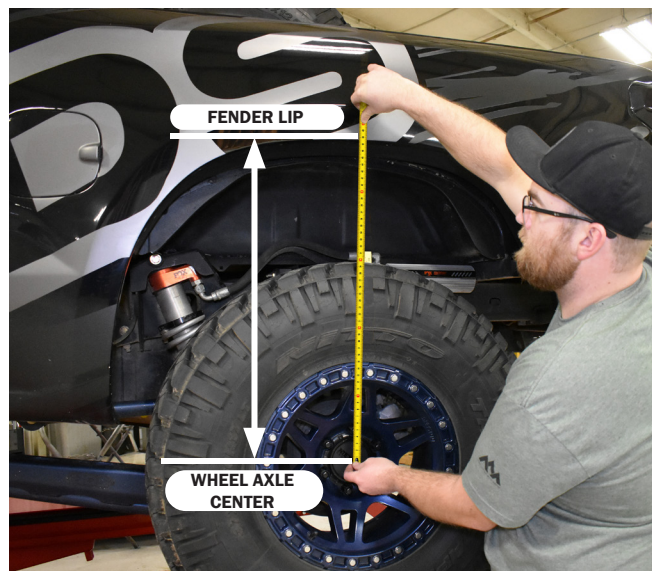
Left Front \_\_\_\_\_ Right Front \_\_\_\_\_

Left Rear \_\_\_\_\_ Right Rear \_\_\_\_\_

#### AFTER

Left Front \_\_\_\_\_ Right Front \_\_\_\_\_

Left Rear \_\_\_\_\_ Right Rear \_\_\_\_\_



**\*\*These ride heights will be required if you have any ride height concerns after installation. Please be prepared to provide these to Technical Support.**

# INSTALLATION INSTRUCTIONS

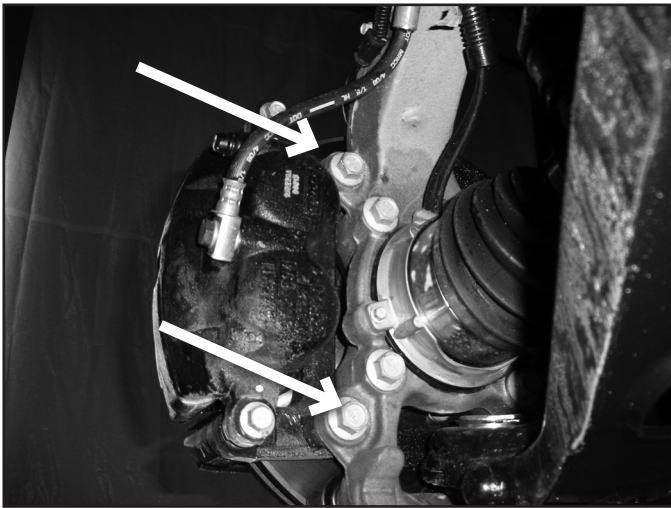
## FRONT INSTALLATION

1. Park the vehicle on a clean, flat surface and block the rear wheels for safety.
2. Measure and record pre-install ride height on the previous page instruction.
3. Raise the front of the vehicle and support with jack stands at each frame rail behind the lower control arms.
4. Remove the front wheels.

**! Caution** EPAS (Electronic Power Assist Steering), disconnect the power steering control module connector to avoid arcing of the contacts in the internal power relay from a hammer blow or impact wrench.

5. Remove all skid plates underneath the vehicle, including the front aluminum Raptor specific skid plate. Set the front aluminum Raptor specific skid plate aside for later installation, all other skid plates and hardware can be discarded.
6. Remove the brake caliper anchor bracket bolts and remove the caliper from the knuckle (Fig 1). Hang the caliper out of the way. Do not let the caliper hang by the brake hoses.

**FIGURE 1**

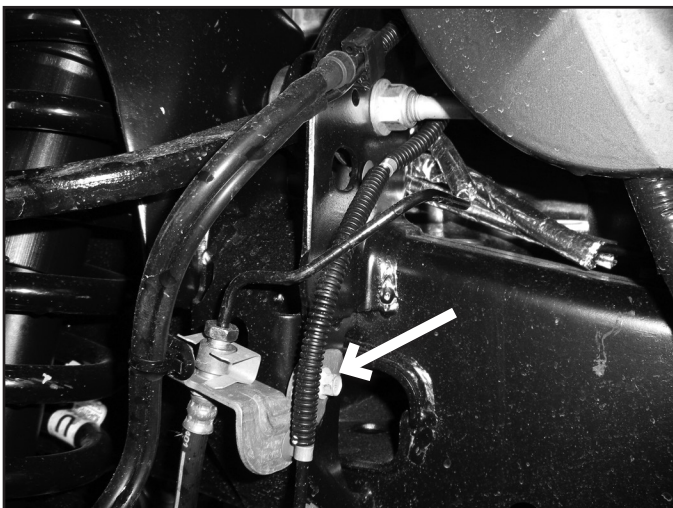


## SPECIAL TOOLS

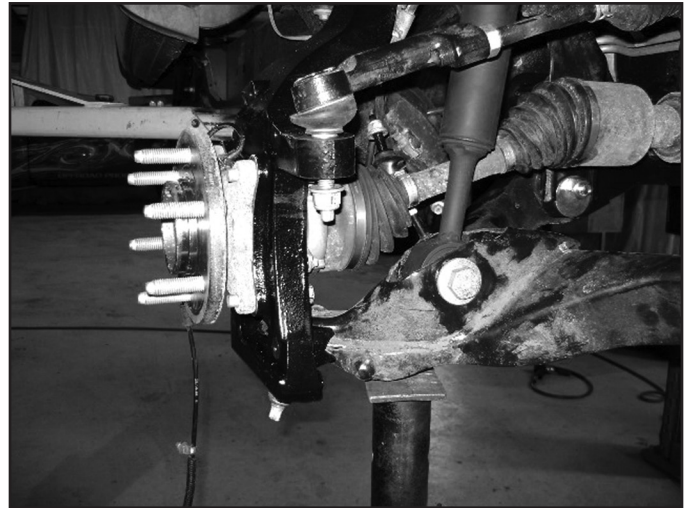
Requires frame bracket modification  
Reciprocating saw or equivalent  
Strut Compressor

7. Remove the brake rotor and set aside.
8. Disconnect the ABS and hub vacuum lines from the retaining clips. Disconnect the brakeline bracket from the frame rail. Disconnect the ABS line from the hub assembly. (Fig 2a / b).

**FIGURE 2A**



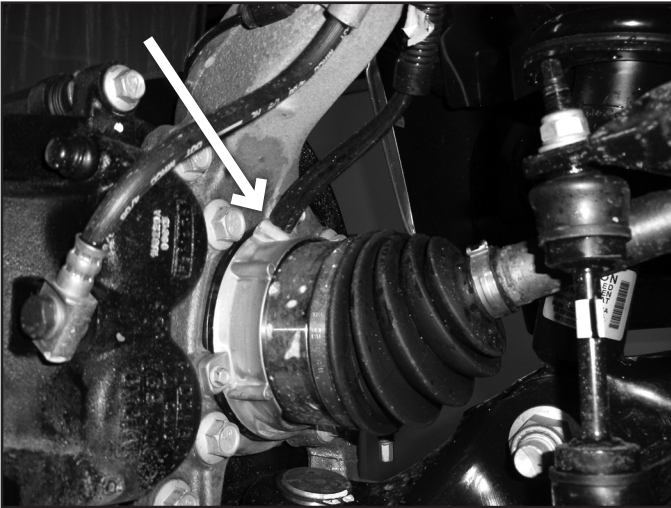
**FIGURE 2B**



9. Disconnect the hub vacuum line from the hub (Fig 3).

10. Disconnect the tie rod ends from the steering knuckles. Remove and retain the mounting nuts. Avoid hitting the aluminum steering knuckle, use appropriate tool to remove tie rod end from steering knuckle. Take care not to strike the tie rod end, or damage the threads. (Fig 4)

**FIGURE 3**



**FIGURE 4**



11. Disconnect the sway bar links from the sway bar (Fig 5). Retain hardware. The sway bar links do not need to be removed from the lower control arms.
12. Remove the four sway bar mounting nuts and remove the sway bar from the vehicle (Fig 6). Retain hardware

**FIGURE 5**

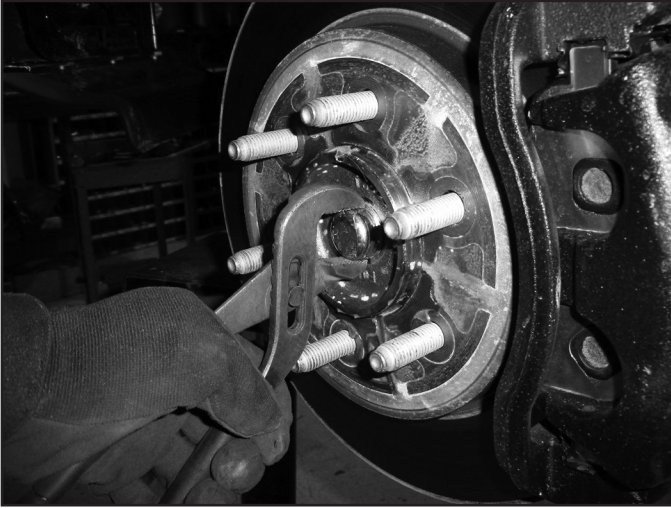


**FIGURE 6**



- Carefully remove the hub dust cap to expose the axle shaft nut (Fig 7 & 8). Remove the nut. Retain the cap and nut, they will be reinstalled later.

**FIGURE 7**



**FIGURE 8**



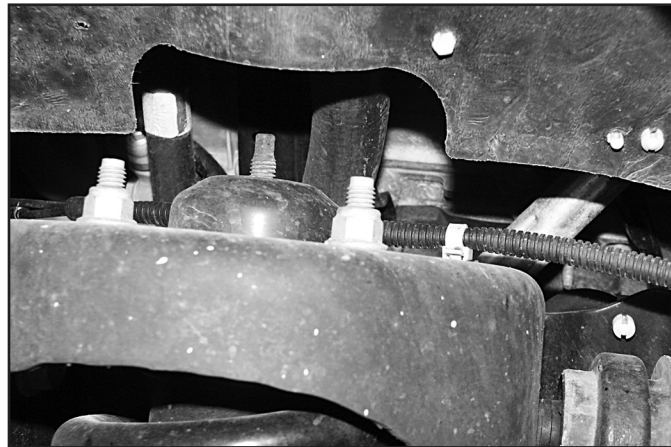
- Loosen but do not remove the three strut assembly mounting nuts at the frame (Fig 8). Do not loosen the middle strut nut.



**Tip**

*It may be easier for the Ford Raptor strut assembly mounting nuts to be loosened through the engine bay.*

**FIGURE 9**



- Remove the upper and lower ball joint nuts, refrain from hitting the aluminum steering knuckle, use appropriate tool to separate ball joints, avoid damaging the threads.
- Remove the upper ball joint and the strut-to-lower control arm hardware. Swing the knuckle/lower control arm down to remove the CV shaft from the hub. Retain ball joint nut and strut bolt.
- Remove the lower ball joint nut and remove the knuckle from the vehicle. Retain hardware.
- Remove the lower control arm mounting bolts and remove the lower control arm from the vehicle. Retain hardware.
- Mark the struts to distinguish between driver's and passenger's.
- Remove the three strut assembly mounting nuts at the frame and remove the strut assembly from the vehicle.



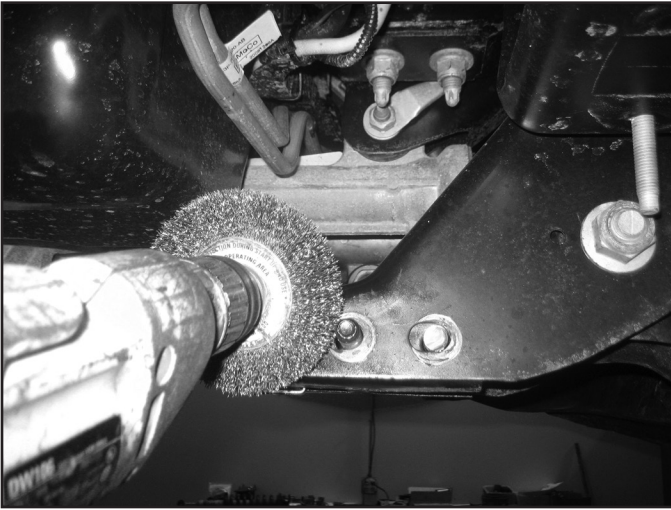
**Tip**

*It may be easier for the Ford Raptor strut assembly mounting nuts to be removed through the engine bay.*

- Take a wire brush and remove the material from the threads of the four bolts that attach the OE rear crossmember. Spray threads with lubricant and remove the bolts and crossmember from the vehicle. Discard the crossmember and hardware. (Fig 10)
- Remove the driveshaft mounting bolts and disconnect the driveshaft from the differential (Fig 11). Allow the driveshaft to rest out of the way.



**FIGURE 10**

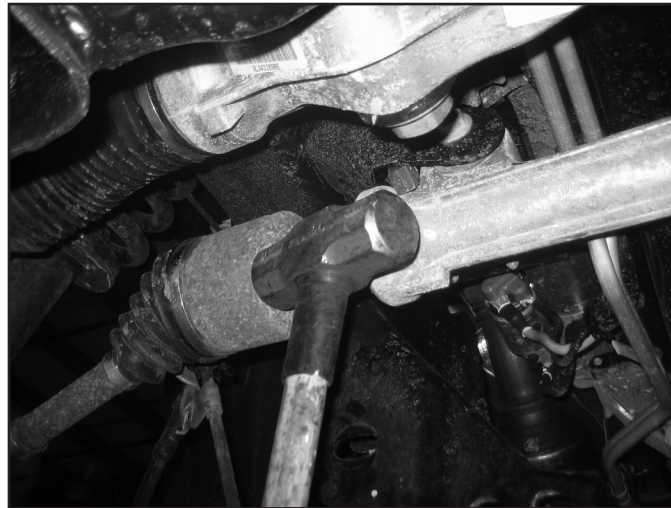


**FIGURE 11**



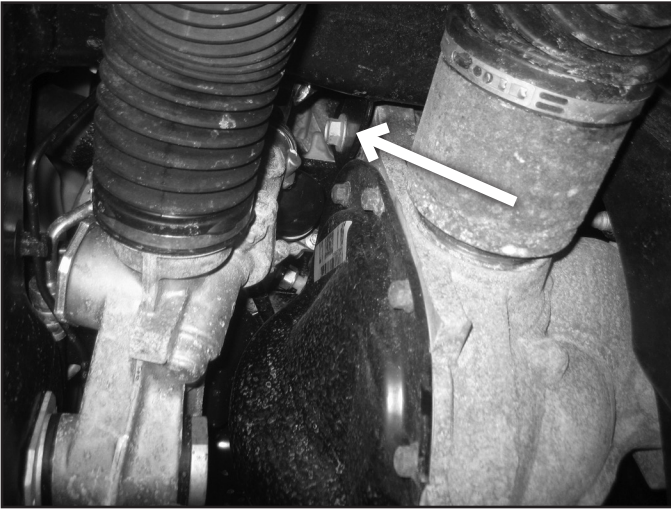
23. Remove the passenger's side CV only. Strike the shaft with a hammer to dislodge it from the splines. This will make handling the differential much easier. (Fig 12)

**FIGURE 12**

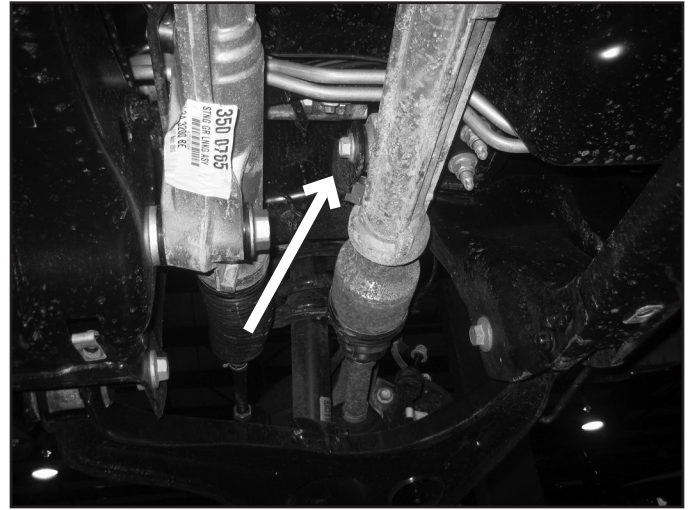


24. Support the front differential with an appropriate jack. Loosen all of the hardware and slide the differential all the way to the passenger's side. Orientate the joint at the steering rack so there is the most possible clearance to remove the front driver's side bolt. Remove this bolt first. Disconnect the differential breather hose from the differential housing. Remove the rear driver's side and one passenger's side differential mounting bolts (Fig 13A & B) and remove the differential from the vehicle.

**FIGURE 13A**

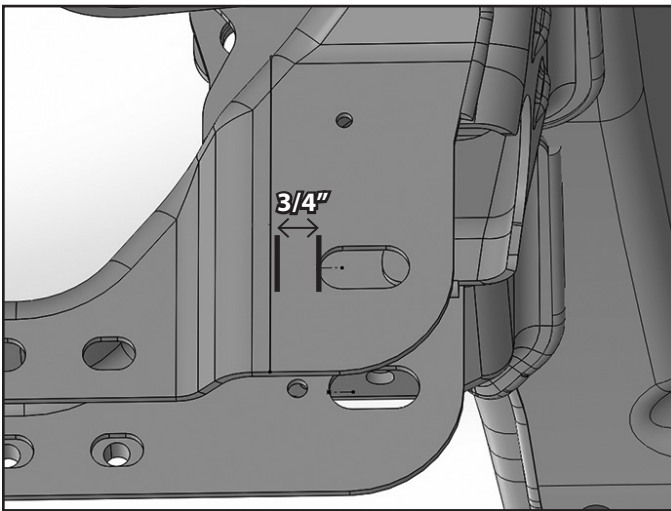


**FIGURE 13B**



25. The driver's side rear lower control arm frame pocket must be modified to provide clearance for the differential in its relocated position. On the front side measure from the inside edge of the slot 3/4" (Fig 14A & B). Make a vertical cut line at the mark.

**FIGURE 14A**



**FIGURE 14B**



26. On the back side measure from the inside edge of the slot 1-3/4" and make and mark a vertical cut. Measure 1" in from the angled top surface and mark (Fig 15).
27. Connect the front cut line straight to the back face. This will require trimming minor trimming on the factory differential mount tab. (Fig 16 & 17)

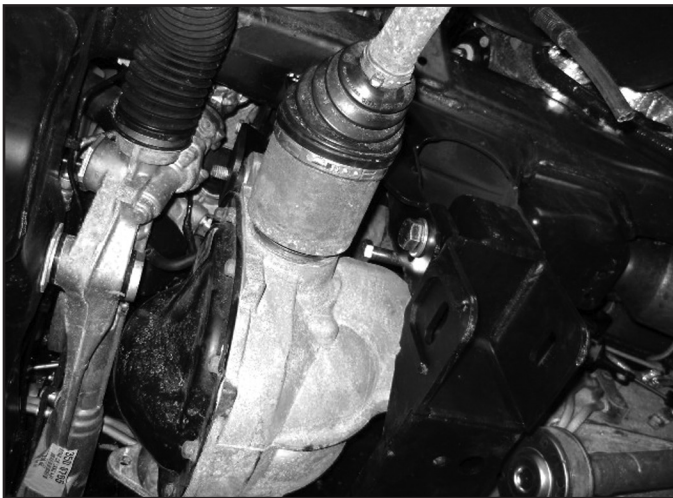


**FIGURE 18**



29. Install the new rear crossmember (02780) in the rear lower control arm frame pockets. Attach the rear crossmember with the sway bar drop brackets (02781) with new 18mm bolts and washers (BP #773). Run bolts from rear to front (Fig 22A). Leave hardware loose. Ensure the cutout made in Figure 15 is adequate to clear the differential mounting bolt. (Fig 19A). Do not tighten hardware at this time.
30. Fasten the differential to the rear crossmember (Fig 19B) with a 9/16" x 1-1/4" bolt, washers, and nut (BP #772). Run the bolt from rear to front. Leave hardware loose.

**FIGURE 19A**

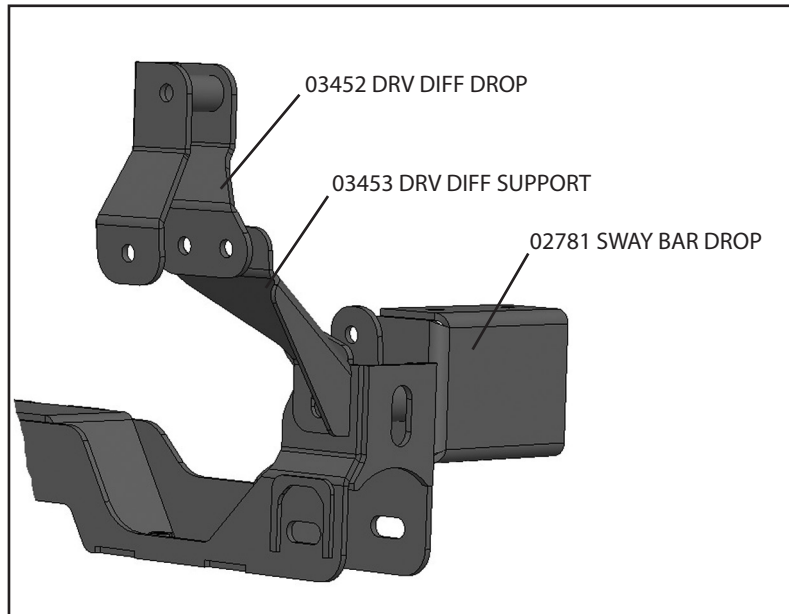


**FIGURE 19B**



31. Fasten the support bracket to the rear of diff drop bracket. Fasten with the driver's side rear crossmember hardware. Attach the hardware at the differential bracket from the front to rear. Leave all hardware loose at this time. (Fig 20A).

**FIGURE 20A**



32. Install the offset differential support bracket to the backside of the passenger's side differential bracket using the hardware that was just installed and a 9/16" x 1-1/4" bolt, washers, and nut (BP #772) to the BDS crossmember. Leave hardware loose. (Fig 20B)

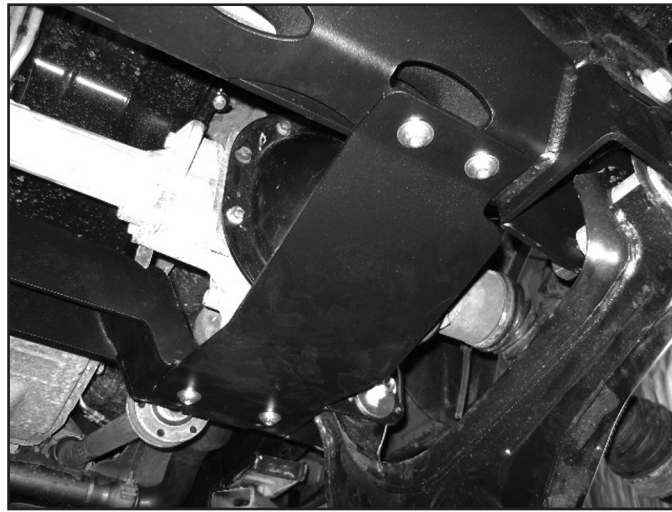
**FIGURE 20B**



33. Torque all of the differential mounting hardware to 95 ft-lbs (10 total). Attach the differential breather tube. Remove the differential breather elbow from the plastic line and replace it with the provided hose and attach it to the differential.
34. Install the front crossmember in the front lower control arm pockets and fasten with the OE lower control arm hardware. Leave hardware loose.
- Note: The edges of the front lower control arm pockets may need to be trimmed for crossmember clearance.*
35. Install the lower control arms in the new cross members and fasten with the provided 18mm cam bolts, cam washers and 18mm nuts. Run the front bolts from front to rear and leave loose. Run the rear bolts from rear to front. The main body of the cam will be 'up' in the cam slot
36. Install skid plate relocation bracket and differential skid plate on the bottom of the front BDS crossmember with three 1/2" x 1-1/4" bolts and 1.2" SAE washers (BP #675) into the weld nuts in the cross members. Leave hardware loose.
- Note: Install the differential skid plate below the skid plate relocation bracket.*
37. Install the differential skid plate to the rear cross members with two 1/2" x 1-1/4" button head bolts and 1/2" SAE washers (BP #773) into the weld nuts in the cross members (Fig 21). Leave hardware loose.

*Note: Figure 21 shows just the differential skid plate installed and not the Raptor skid plate relocation bracket.*

**FIGURE 21**

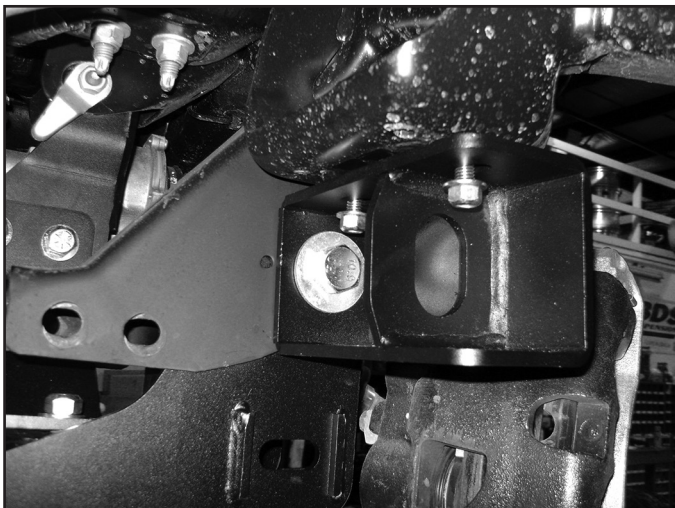


38. Attach the sway bar drop brackets with new 3/8" x 1-1/4" bolts, washers and nuts. Run hardware from bottom - up, snug but do not tighten at this time.

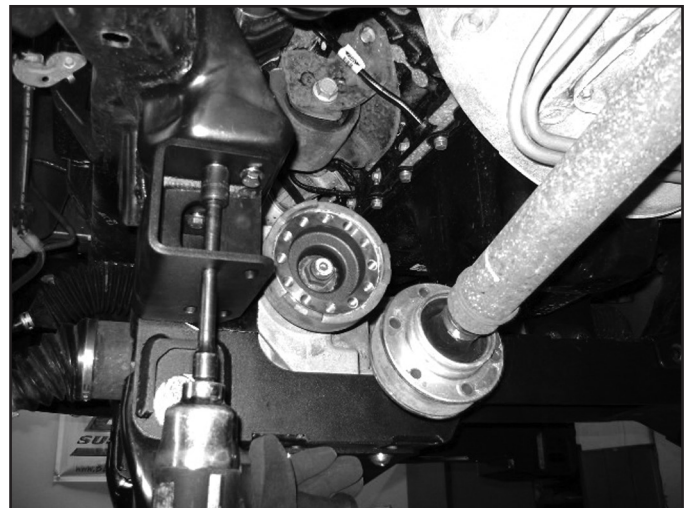


**Tip** Use a ratchet extension through the lower slots to access the hardware (Fig 22a/ b)

**FIGURE 22A**



**FIGURE 22B**



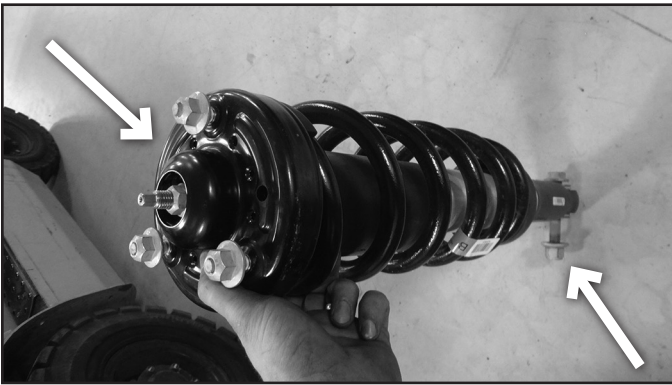
39. With the lower control arms installed torque the four crossmember mounting bolts to 222 ft-lbs. Ensure that the front crossmember is centered in the vehicle. Torque the differential skid plate bolts to 65 ft-lbs. Tighten sway bar drop hardware to 35 ft-lbs.
40. Reinstall the passengers side CV.

## STRUT INSTALLATION

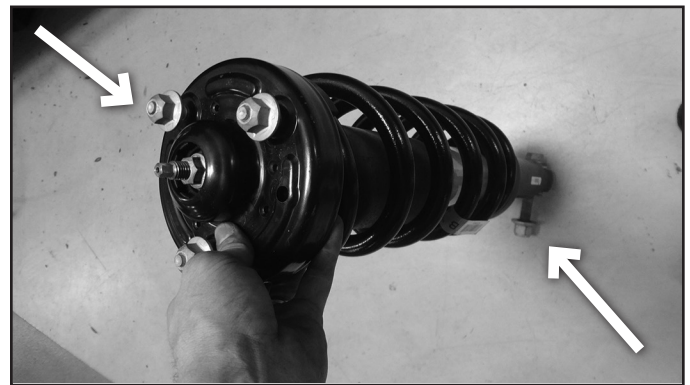
41. The driver side top strut mount will need to be rotated 180 degrees from how it was from the factory. This is to aid in tie rod clearance. Using a strut compressor, compress the spring and rotate the top strut mount 180 degrees as shown in the Figures 23A (Before) & Figure 23 B (After).

*Note: Only the driver's side top strut mount will need to be rotated.*

**FIGURE 23A**



**FIGURE 23B**



42. The same strut spacer is used on both sides. Place the 02427 strut spacer on each strut and attach with new 10mm nuts and washers (BP #629). Tighten to 40 ft-lbs.
43. Install the strut and spacer assembly into the vehicle. Attach to upper mount with new 7/16" nuts and washers (BP #769). Leave hardware loose at this time. (Fig 24).

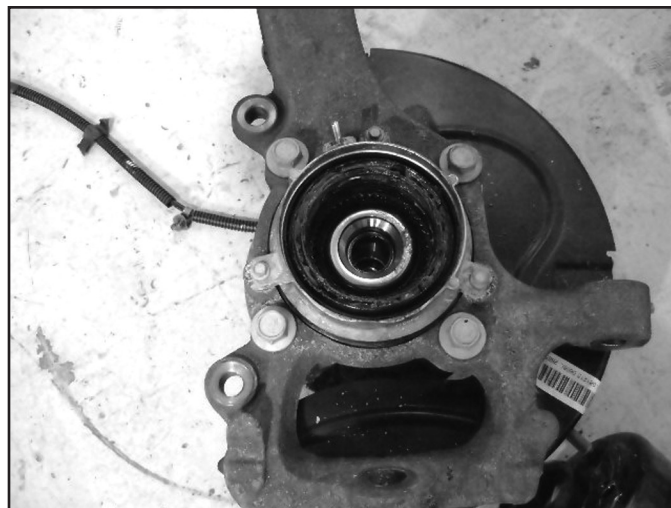
**FIGURE 24**



## **KNUCKLE INSTALLATION**

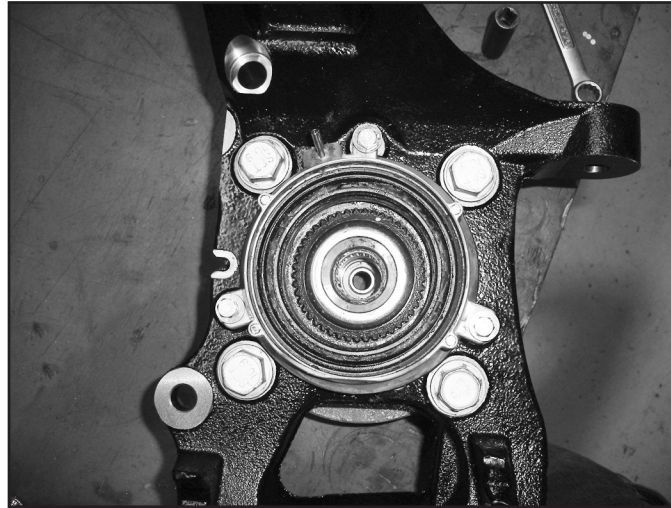
44. Remove the four hub bolts from the knuckle and remove the hub from the knuckle (Fig 25). Inspect mounting surface of the hub assembly and clean any dirt or corrosion off as necessary.

**FIGURE 25**



45. Install the hub into the corresponding new BDS knuckle (Drv- 02065, Pass- 02067) and fasten with the OE bolts. The ABS wire will be located at the 'top' of the hub. Use thread locker on the bolt threads and torque to 148 ft-lbs.
46. Remove the three 6mm bolts mounting the vacuum hub assembly to the inside of the OE knuckle (Fig 26). Transfer the vacuum assembly over to the new knuckle. Make sure the vacuum port is pointing towards the top. Attach with the OE bolts, tighten bolts securely (about 5-7 ft-lbs).

**FIGURE 26**

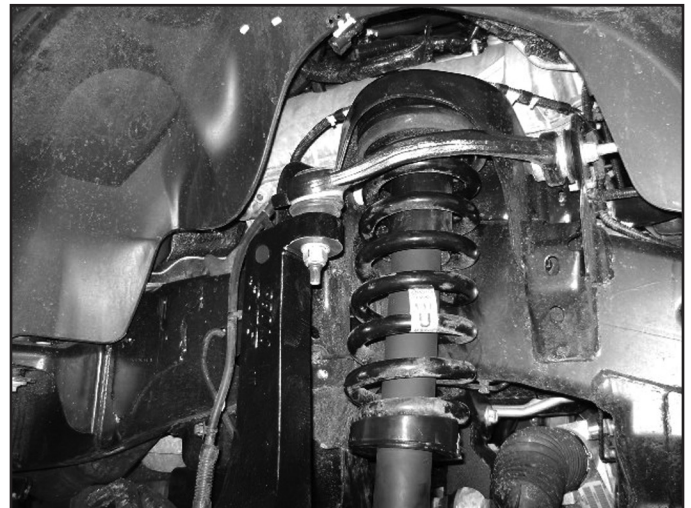


47. Install the dust shield with the factory 6mm bolts, tighten bolts securely (about 5-7 ft-lbs).
48. Install the new knuckle assembly on the lower control arm ball joint and loosely fasten with the original nut with new large machined washer (02487). Install the CV shaft in the hub, swing the whole assembly up and attach the lower control arm to the strut with the original hardware. Leave all hardware loose.
49. Attach the upper control arm to the knuckle with the original nut. The lower ball joint will get the large machined washer (Fig 27A) (02487) included in the knuckle box kits, make sure the washer is centered before torquing lower ball joint nut. Torque the upper ball joint to 85 ft-lbs and the lower ball joint to 111 ft-lbs. (Fig 27B)

**FIGURE 27A**



**FIGURE 27B**

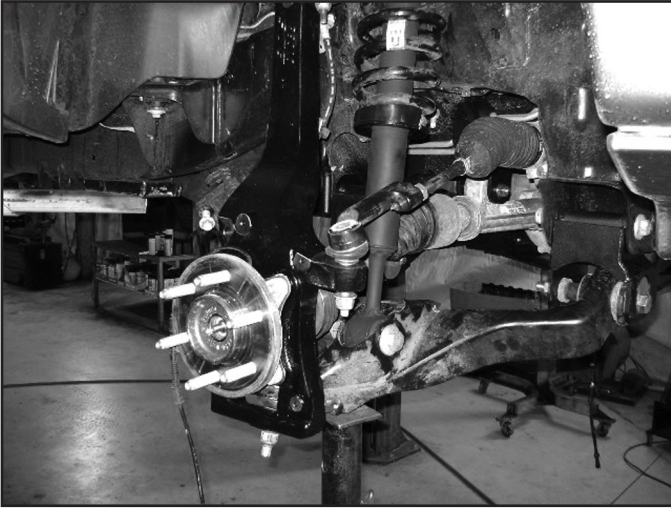


50. Torque the upper strut nuts to 35 ft-lbs. The lower bolt will be tightened later with the weight of the vehicle on the suspension.
51. Fasten the CV shaft to the hub with the original nut. Make sure the splines are engaged properly in the vacuum actuated section of the hub. The hub should have a very minor amount of rotational play with the CV shaft if installed properly, torque to 20 ft-lbs. Reinstall the dust cap.
52. Install tie rod from top-down. Torque to 111 ft-lbs.
53. Install the brake rotor and caliper to the knuckle with OE bolts. Torque to 148 ft-lbs.
54. Install the brake line relocation brackets (01602) at the frame. Attach with OE hardware to frame, attach brakeline retaining clip with 1/4" nut and washer (BP #773) to the relocation bracket. Tighten to 15 ft-lbs.

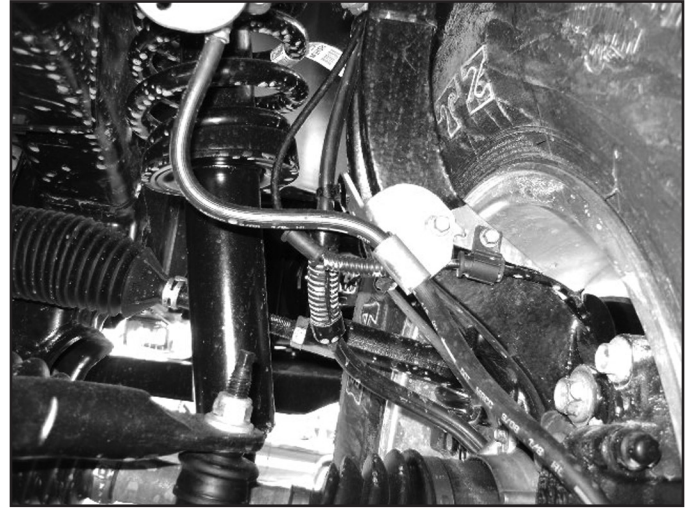


55. Attach the ABS line to the connector at the inner fender and the vacuum line to the hub. Route the lines similar to the factory setup down to the side of the knuckle. Attach the ABS wire with the factory 6mm bolt to the side of the knuckle. Attach the brakeline with a new 6mm x 18mm bolt with 1/4" washer to the side of the knuckle (BP #773), the brakeline locating tab will go into the unthreaded hole. (Fig 28A & B).

**FIGURE 28A**



**FIGURE 28B**



56. Install the sway bar to the new sway bar drop brackets with 7/16" x 1-1/4" bolts, nuts and 7/16" SAE washers (BP #772). Attach the sway bar to the sway bar end links with the original hardware. Torque the 7/16" hardware to 45 ft-lbs. Torque sway bar link nut to 45 ft-lbs.
57. Install the supplied driveshaft spacer and reattach front driveshaft to differential with new hardware (BP #925) and thread locker. Torque bolts to 76 ft-lbs. (Fig 29)

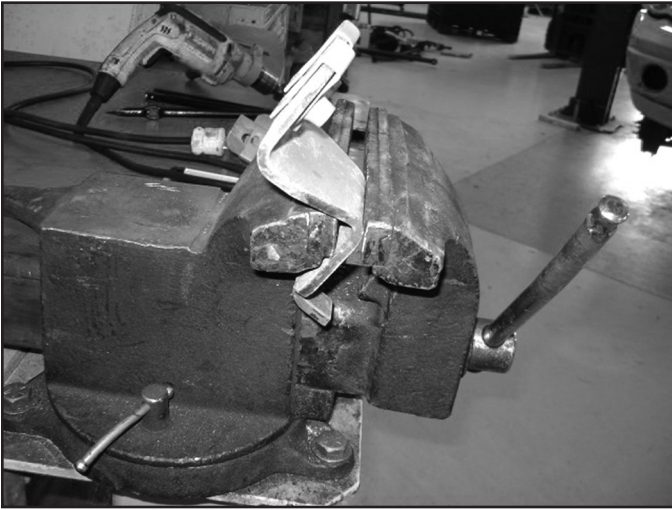
**FIGURE 29**



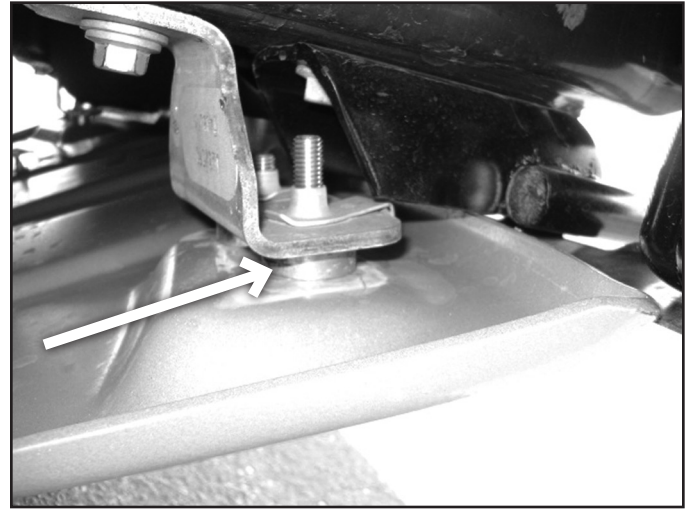
## SKID PLATE INSTALLATION

58. Remove the factory frame skid plate mounting brackets. Bend the brackets slightly approximately 10 degrees to allow the skid plate to be reattached. (Fig 30A)
59. Trim the factory skid plate to have a tab that is 20" wide following the original reliefs that will fit in between the crossmember pockets (Fig. 30C).
60. Install skid plate with new 10mm x 40mm hardware (BP #675) with spacers as shown (Fig. 30B). Do not tighten at this time. Mark the center of the holes, removed skid plate, and drill factory skid plate to 1/2" (Fig. D). Check the factory skid plate frame mounting brackets, additional tweaking may be required. (Fig 30A, 30B, 30C, & 30D)

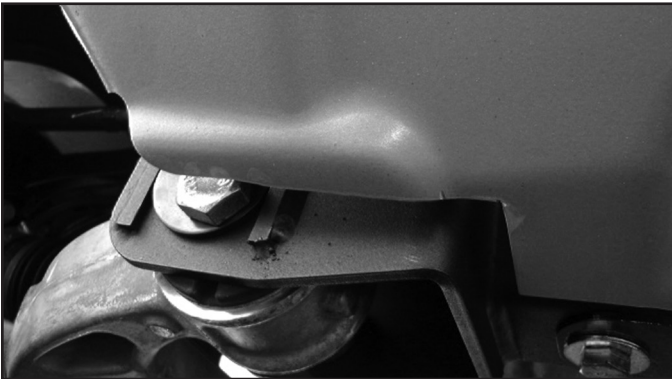
**FIGURE 30A**



**FIGURE 30B**



**FIGURE 30C**



**FIGURE 30D**

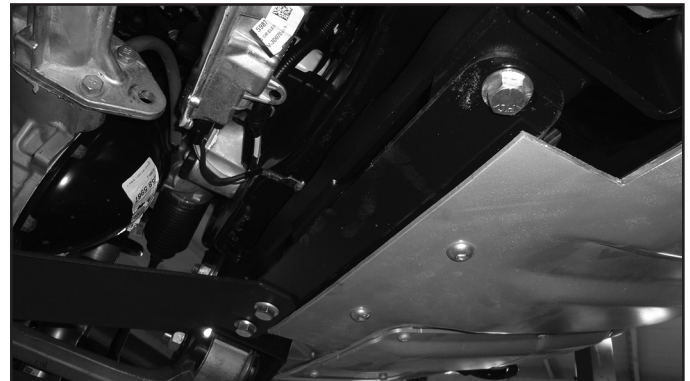


61. Reinstall front skid plate with 1/2" hardware and 10mm hardware with spacers. (BP #675) Tighten 10mm hardware to 35ft-lbs and 1/2" hardware to 55 ft-lbs. (Fig. 31 A & B)

**FIGURE 31A**



**FIGURE 31B**



62. Install the wheels and lower the vehicle to the ground.
63. Bounce the front of the vehicle to settle the suspension. Torque the lower strut mount bolts to 80 ft-lbs. Center the lower control arm cams and torque to 250 ft-lbs. Tighten upper strut mounting hardware on replacement strut kits to 35 ft-lbs. Adjust the toe before driving it to an alignment shop.
64. Cycle steering, the crash bars that protrude from the frame may create clearance issues with the front tires. Modifications may be required for clearance.
65. Check all hardware for proper torque.

## REAR INSTALLATION

66. Block the front wheels and raise the rear of the vehicle. Place jack stands under the frame rails ahead of the spring hangers.
67. Remove the wheels.
68. Disconnect the rear brake line from the top of the rear differential. Discard hardware. (Fig. 32)

**FIGURE 32**



69. Disconnect the ABS line from the frame mount on the driver's side. Retain mounting hardware.
70. Support the rear axle with a hydraulic jack. Remove the OE shocks. Discard hardware.  
*Note: Perform the rear installation on one side at a time.*
71. The shock relocation brackets can now be installed. Slide the brackets over the backside of the factory mount. Place the spacer sleeve inside and attach with new 12mm x 80mm hardware (BP #676) Drill the hole on the backside of the bracket to 3/8". Attach to backside of bracket with 3/18" x 1-1/4" bolt with serrated edge flanged nut (BP #676). Tighten the 3/8" bolt to 35 ft-lbs. (Fig. 33)

*Note: The relocation brackets will be a tight fit so that the shock relocation is a strong mount. Use of a dead blow hammer or hammer with block of wood may be required for install.*

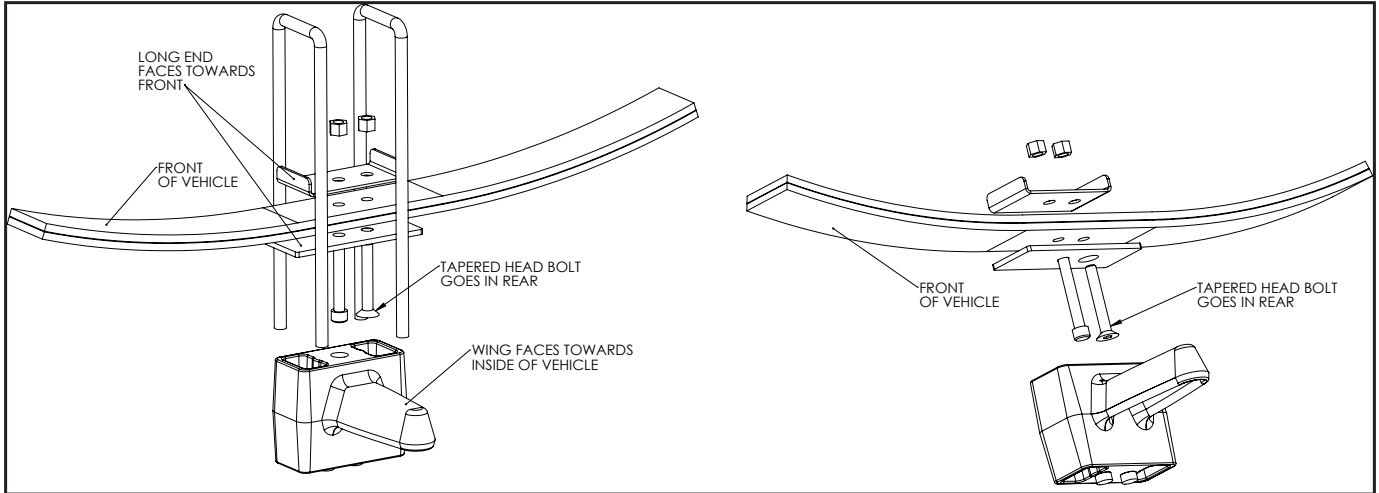
**FIGURE 33**



## REAR BLOCK INSTALLATION

72. Remove the passenger's side U-bolts.
73. Lower the axle and remove the OE lift block, it will not be reused.
74. Using C-clamps, clamp the leaf spring pack together on each side of the center pins. Remove the center pins and discard.
75. Place the plate on the bottom of the leaf pack and secure with new center pin in the 'forward' hole and flat head allen bolt through the 'rear' hole. Install new u-bolt retaining plate on top, it will be offset 'forward'. Tighten to 35 ft-lbs. (Fig 34 A, B, & C)

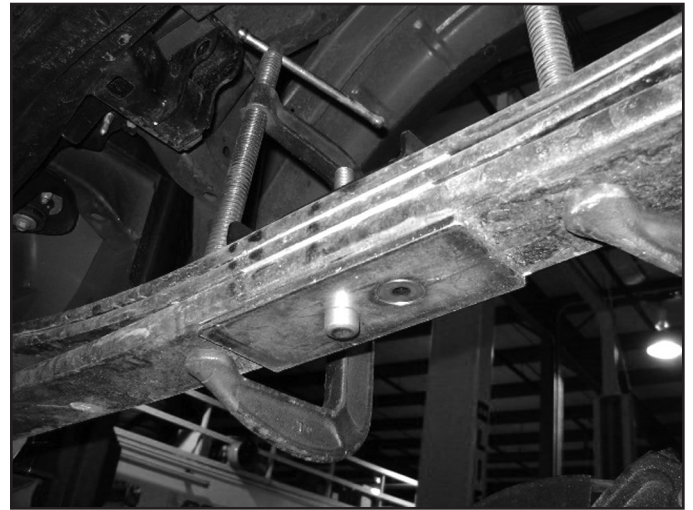
**FIGURE 34A**



**FIGURE 34B**

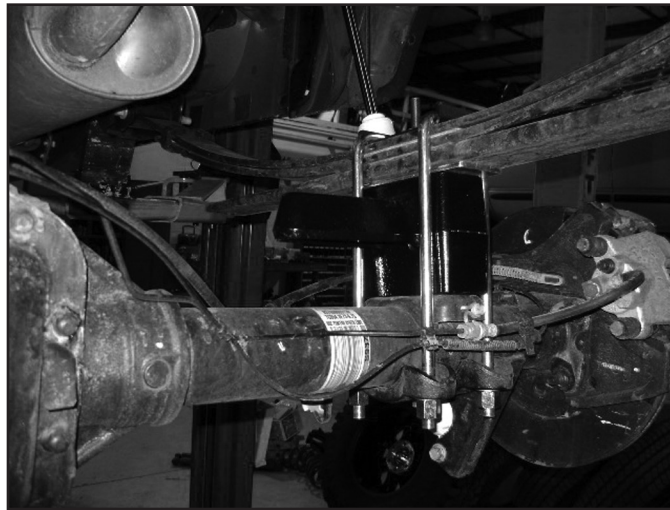


**FIGURE 34C**



76. Install the new provided lift block so that the bump stop wing goes toward the inside of the vehicle (Fig 35). The block will use the both of the lower center pin holes. The upper only uses 1 hole which will shift the axle slightly forward.

**FIGURE 35**



77. Raise the axle/block to the spring while aligning the center pin. Fasten the spring/block assembly with the provided U-bolts, high nuts and washers. Snug U-bolts, they will be torqued with the weight of the vehicle on the springs.
78. Reattach the shocks to the relocation brackets with new 12mm x 80mm hardware (BP #676). Use a spacer washer on EACH side of the lower shock bushing, the spacer washer is in Bolt Pack #676 and is the extra thick washers. Tighten 12mm shock relocation bracket hardware to 55 ft-lbs. (Fig. 36)

*Note: The Fox shocks are tough to compress, it may be easiest to disconnect the upper mount and attach the bottom first, then reattach the top with factory hardware.*

**FIGURE 36**



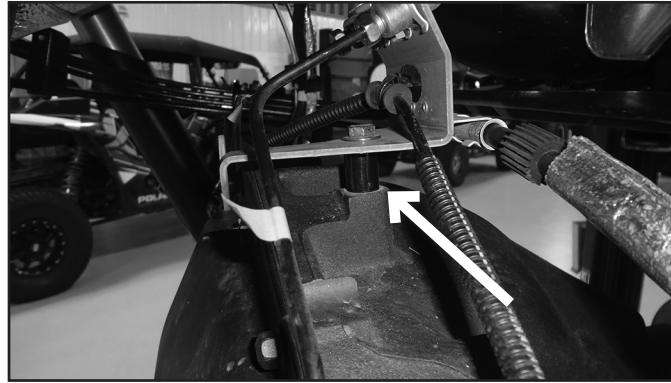
79. Install the provided brake line relocation bracket to the driver's side frame rail with the OE brake line bracket bolt (Fig 37). Torque to 15 ft-lbs.
80. Attach the brake line to the relocation bracket with a 1/4" nut and 1/4" washer (BP #697). It may be necessary to rotate the OE brakeline clip bracket to have the lines face 'down' for adequate slack. Torque to 15 ft-lbs.

**FIGURE 37**



81. Install the provided spacer washer between the rear differential and rear brake line bracket attaching the with the 5/16" bolt and washer (BP #697) and thread locker. (Fig. 38)

**FIGURE 38**



82. Check all lines/wires for proper slack.
83. Reconnect the power steering control module connector.
84. Install the wheels and lower the vehicle to the ground.
85. Bounce the rear of the vehicle to settle the suspension.
86. Torque the U-bolts to 100-120 ft-lbs.
87. Check all hardware for proper torque
88. Check hardware after 500 miles.
89. A complete front end alignment is necessary.
90. Adjust headlights.



### **WE WANT TO SEE YOUR RIDE!**

Grab photos of your BDS-equipped truck in action and send them in for a chance to be featured. Send it in to our Bad Ass Rides customer gallery at [bds-suspension.com/bar](http://bds-suspension.com/bar) and post them on the BDS Fan Page on Facebook at [facebook.com/BDSSuspensions](https://facebook.com/BDSSuspensions). Don't forget about your BDS swag! BDS offers t-shirts, hoodies, decals and more available on the BDS website or through your local BDS distributor.

---

## **TIME TO HAVE SOME FUN**

### **Thank you for choosing BDS Suspension.**

For questions, technical support and warranty issues relating to this BDS Suspension product, please contact your distributor/installer before contacting BDS Suspension directly.