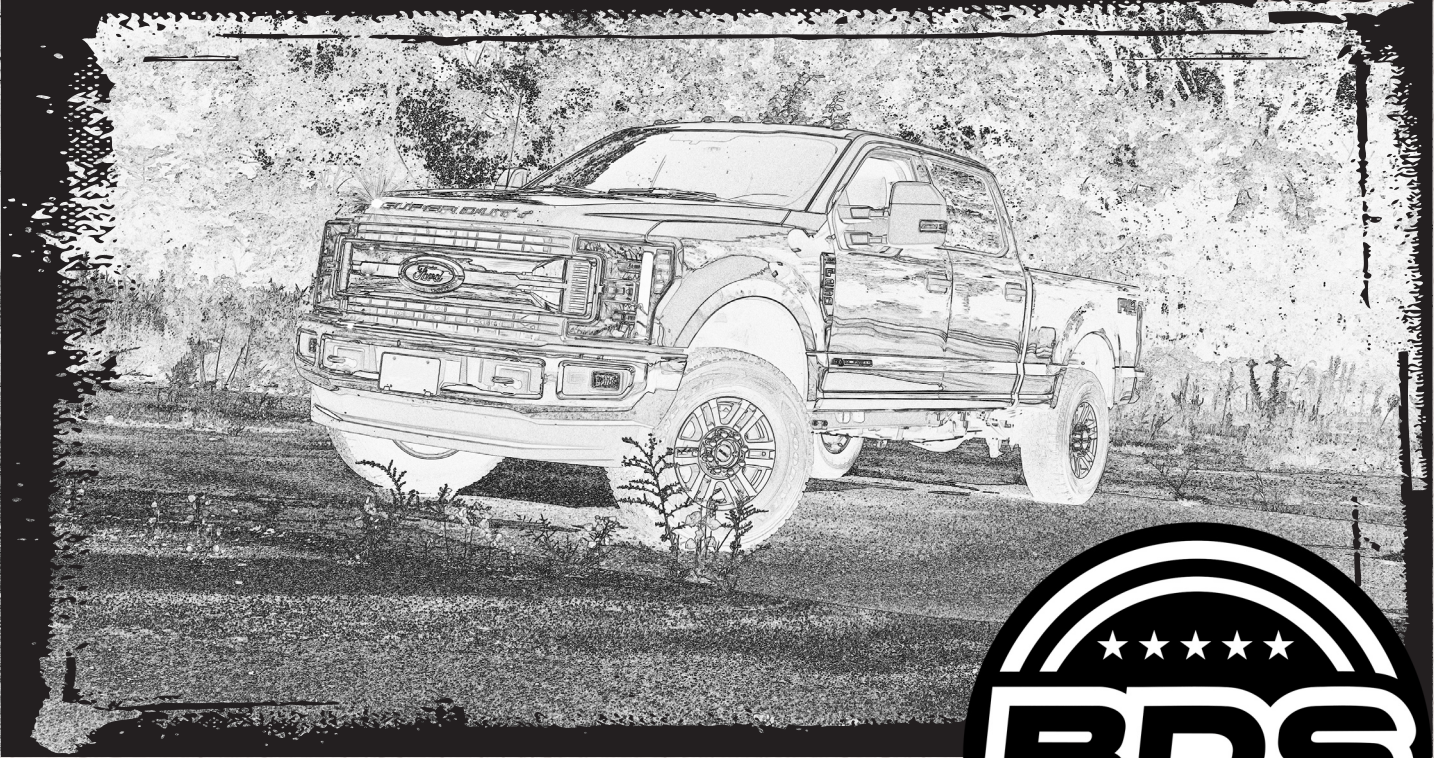


# INSTALLATION GUIDE



Part#: 013261



**HARDCORE LIMITED LIFETIME WARRANTY**

## 2.5"/3" Radius Arm Kit

**Ford F-250, F350 | 2020-2023**

Rev.082523

491 W. Garfield Ave., Coldwater, MI 49036 • Phone: 517-279-2135  
Web: [www.bds-suspension.com](http://www.bds-suspension.com) • E-mail: [tech-bds@ridefox.com](mailto:tech-bds@ridefox.com)

# Read And Understand All Instructions And Warnings Prior To Installation Of System And Operation Of Vehicle.



## THANK YOU

Your truck is about to be fitted with the best suspension system on the market today. That means you will be driving the baddest looking truck in the neighborhood, and you'll have the warranty to ensure that it stays that way for years to come. Thank you for choosing BDS Suspension!

### BEFORE YOU START

BDS Suspension Co. recommends this system be installed by a professional technician. In addition to these instructions, professional knowledge of disassembly/ reassembly procedures and post installation checks must be known.

### FOR YOUR SAFETY

Certain BDS Suspension products are intended to improve off-road performance. Modifying your vehicle for off-road use may result in the vehicle handling differently than a factory equipped vehicle. Extreme care must be used to prevent loss of control or vehicle rollover. Failure to drive your modified vehicle safely may result in serious injury or death. BDS Suspension Co. does not recommend the combined use of suspension lifts, body lifts, or other lifting devices. You should never operate your modified vehicle under the influence of alcohol or drugs. Always drive your modified vehicle at reduced speeds to ensure your ability to control your vehicle under all driving conditions. Always wear your seat belt.

### BEFORE INSTALLATION

- Special literature required: OE Service Manual for model/year of vehicle. Refer to manual for proper disassembly/reassembly procedures of OE and related components.
- Adhere to recommendations when replacement fasteners, retainers and keepers are called out in the OE manual.
- Larger rim and tire combinations may increase leverage on suspension, steering, and related components. When selecting combinations larger than OE, consider the additional stress you could be inducing on the OE and related components.
- Post suspension system vehicles may experience drive line vibrations. Angles may require tuning, slider on shaft may require replacement, shafts may need to be lengthened or trued, and U-joints may need to be replaced.
- Secure and properly block vehicle prior to installation of BDS Suspension components. Always wear safety glasses when using power tools.
- If installation is to be performed without a hoist, BDS Suspension Co. recommends rear alterations first.
- Due to payload options and initial ride height variances, the amount of lift is a base figure. Final ride height dimensions may vary in accordance to original vehicle attitude. Always measure the attitude prior to beginning installation.



Visit [560plus.com](http://560plus.com) for more information.

### TIRES AND WHEELS

35x12.50x17(18)(20) Tire  
4-1/2" ~ 5" Backspace Wheel



### BEFORE YOU DRIVE

Check all fasteners for proper torque. Check to ensure for adequate clearance between all rotating, mobile, fixed, and heated members. Verify clearance between exhaust and brake lines, fuel lines, fuel tank, floor boards and wiring harness. Check steering gear for clearance. Test and inspect brake system.

Perform steering sweep to ensure front brake hoses have adequate slack and do not contact any rotating, mobile or heated members. Inspect rear brake hoses at full extension for adequate slack. Failure to perform hose check/ replacement may result in component failure. Longer replacement hoses, if needed can be purchased from a local parts supplier.

Perform head light check and adjustment.

Re-torque all fasteners after 500 miles. Always inspect fasteners and components during routine servicing.

# CONTENTS OF YOUR KIT

## BDS 033251 - 2.5" Coil Springs

Part #	Qty	Description
033251R	2	Coil Springs

## Rear Kit BDS 013108 - 1" Bolt-on Block

Part #	Qty	Description
01015B	2	1in x 3in Wide Steel block
583181600SB	4	5/8" x 3-1/8" x 16 Semi-Round U-bolt
760600FCP	2	Center Pin
B949	1	Bag Kit - 5/8" U-Bolts
N58FHB	8	5/8" Fine High Nut - Black
W58SB	8	5/8" Washer - Black

## 123263 - Radius Arm Box Kit (2023)

Part #	Qty	Description
A444	1	2023 Radius Arm Assembly - DRV Side
05356	1	2023 Super Duty Radius Arm- Drv
868190	1	Ford F250 Control Arm Bushing
A445	1	2023 Radius Arm Assembly- PASS side
05357	1	2023 Super Duty Radius Arm- Pass
868190	1	Superduty Bushing
02802	2	BDS Badge
995	1	Rivet Bolt Pack
05358	4	3 Position Radius Arm Cam
02002ZP	2	M18-2.5 x 150 Bolt
N18MPT	2	M18-2.5 Lock Nut
W34SAE	4	3/4" SAE flat washer
099000	4	Zip Ties
099002	2	Push Pin Zip Ties

## BDS 013261 - 2.5" Front Box Kit - Replacement Radius Arm

Part #	Qty	Description
B1403	1	Bag Kit - 2.5" w/ Rad Arm
422	1	Bolt Pack - Sway Bar Drop
696	1	Bolt Pack - Bump Stop & Brake Line
341	2	Bolt pack - ABS wire clamp
01253	1	Sway Bar Drop - DRV
01254	1	Sway Bar Drop - PASS
A291	1	Front Adjustable Trackbar
B1068	1	Bag Kit - Adjustable Trackbar
3535BK	2	Bushing - black
107	1	1.125 x .156 x 1.745 DOM Tube
516	1	1/4in - 28 Grease Zerk (#60105)
3196	2	3" Dia x 1-1/2" tall bump stop
02998	1	2017 SD Brakeline Brkt - Drv
02999	1	2017 SD Brakeline Brkt- Pass

## BDS 123251 - Radius Arm Box Kit

Part #	Qty	Description
A241	1	Superduty Replacement Rad Arm - DRV
02799	1	Superduty Replacement Arm
868190	1	Rad Arm Bushing
97525A430	2	Stainless Rivet
02802	1	Stainless Radius Arm Logo Plate
A242	1	Superduty Replacement Rad Arm - Pass
02799	1	Superduty Replacement Arm
868190	1	Rad Arm Bushing
97525A430	2	Stainless Rivet
02802	1	Stainless Radius Arm Logo Plate
B1114	1	Bag Kit - Replacement Radius Arm
02421	4	Caster Cam Plates
02002ZP	2	M18-2.50 X 150mm Bolt
N18MPT	2	M18-2.50 Prevailing Torque Nut
W34SAE	4	Washer
099002	2	Zip Tie - Push In
099000	6	Zip Tie

# TECH TIPS

## TROUBLESHOOTING INFORMATION FOR YOUR VEHICLE

1. *This kit is not compatible with trucks equipped with radius arm mounted ride height sensors.*
2. Larger tires on stock wheels are not recommended due to brakeline clearance required. Use recommended specifications listed in tire and wheel fitment section.
3. Trackbar mounting bolt requires 405 ft-lbs of torque, plan ahead on how to achieve this.
4. Steering on F-250/F-350 trucks can be stiff from the factory. Replacement radius arms with increased caster typically help this issue. The base 2.5" lift with ball joint cams and or steering stabilizer options will not fix this problem. We have had success in reducing the torque specification to 85 ft-lbs for the upper ball joint. Use this as a last resort to cure factory steering issues.
5. Kit works on Gas model trucks. Gas models will achieve 1/2" more lift in the front.

## PRE INSTALLATION

### IMPORTANT

It is required that ride height measurements be taken before and after installation. Measure from the **WHEEL AXLE CENTER** up to the **FENDER LIP** of the wheel opening. Do this for all 4 wheels. Record measurements below.\*\*

#### BEFORE

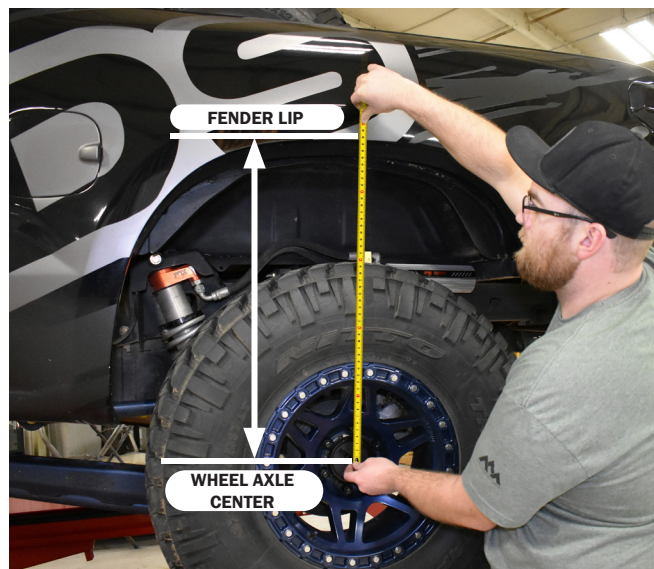
Left Front \_\_\_\_\_ Right Front \_\_\_\_\_

Left Rear \_\_\_\_\_ Right Rear \_\_\_\_\_

#### AFTER

Left Front \_\_\_\_\_ Right Front \_\_\_\_\_

Left Rear \_\_\_\_\_ Right Rear \_\_\_\_\_



**\*\*These ride heights will be required if you have any ride height concerns after installation. Please be prepared to provide these to Technical Support.**

# INSTALLATION INSTRUCTIONS

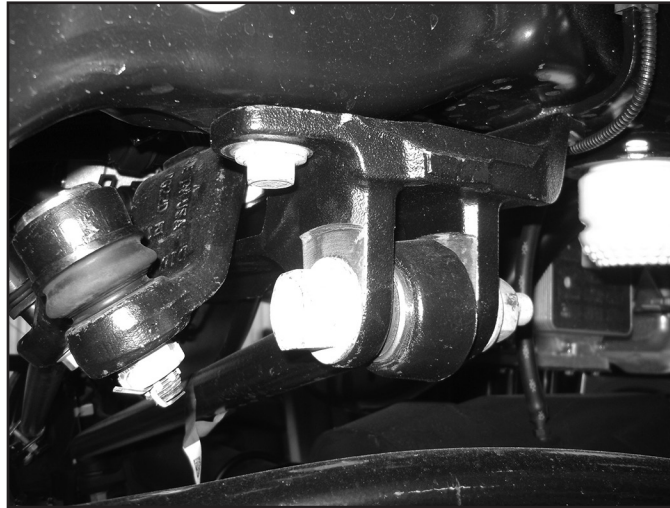
## SPECIAL TOOLS

### INSTALLATION INSTRUCTIONS

General tools, jacks, jack stands.  
30mm (1-3/16") Socket  
Small Pitman Arm Puller

1. Park the vehicle on a clean, flat surface and block the rear wheels for safety.
2. Disconnect the track bar from the frame bracket. Retain OE hardware. It is easiest to disconnect the track bar before the vehicle is lifted in the air. (Fig 1) Remove the track bar from the axle end. This can be done by removing the ball joint nut at the axle. Reinstall the nut a couple of turns to prevent damage to OE track bar joint threads. Use appropriate puller (small pitman arm puller works in most cases) to dislodge the taper from the axle bracket.
3. Remove the stock track bar. If this is used in conjunction with a BDS lift kit with replacement track bar bracket, save the cam plates. Retain all hardware.

**FIGURE 1**



4. Raise the front of the vehicle and support under the frame rails with jack stands.



#### Tip

*As a result of the location of the long radius arm suspension, support locations are limited. Use your best judgment while supporting the vehicle with sufficient strength stands at appropriate locations. The radius arms will need to move freely during this installation.*

5. Remove the front wheels.
6. Support the front axle with a hydraulic jack. With the axle supported this installation can be performed on both sides at the same time.

#### FRONT DISASSEMBLY:

7. Remove the vacuum line from the top of the radius arm on the driver's side (Fig 2a). Remove the vacuum line from the engine crossmember (Fig 2b).

**FIGURE 2A**



**FIGURE 2B**



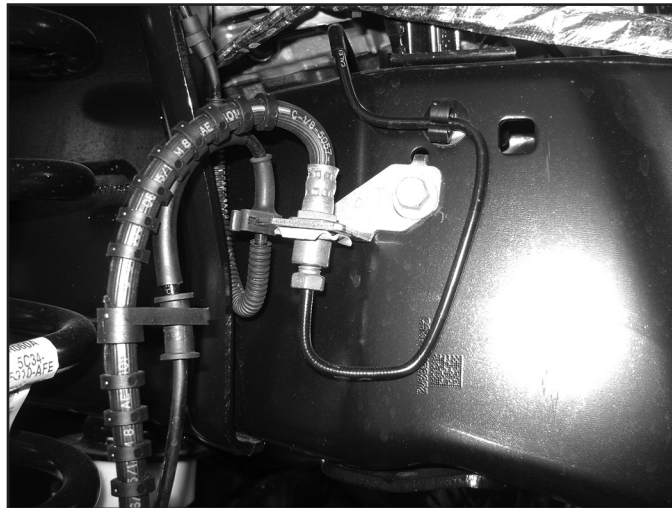
8. Remove the brake line bracket from the lower coil seat. Retain hardware. (Fig 3)

**FIGURE 3**



9. Disconnect the brake line bracket frame (Fig 4). Retain hardware.

**FIGURE 4**



- Carefully cut the factory bracket so that the brake line can be removed without breaking loose the fittings. Remove the factory brake lines from vehicle. Do not damage the brake line! (Fig. 5)

**FIGURE 5**

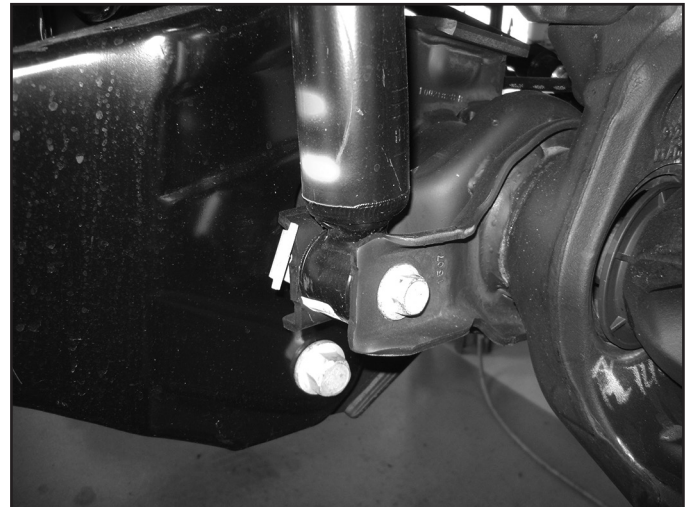


- Disconnect the shocks by removing factory hardware (Fig 6a, 6b). Retain lower bolt and nut tab for later reinstallation.

**FIGURE 6A**

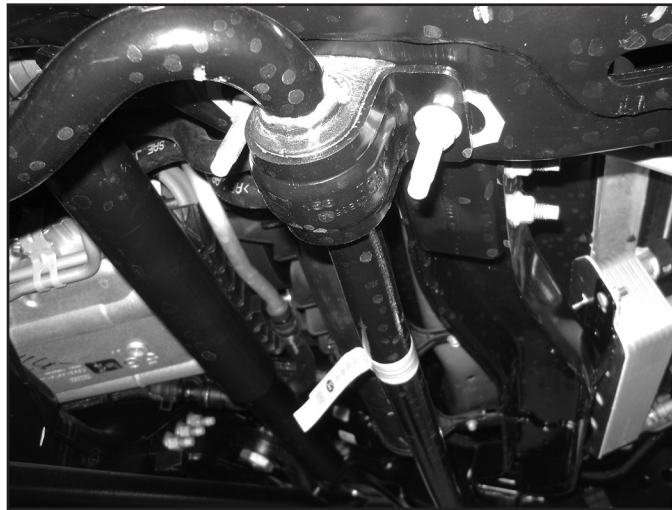


**FIGURE 6B**



- Disconnect sway bar from the frame. Retain (4) mounting nuts. (Fig 7)

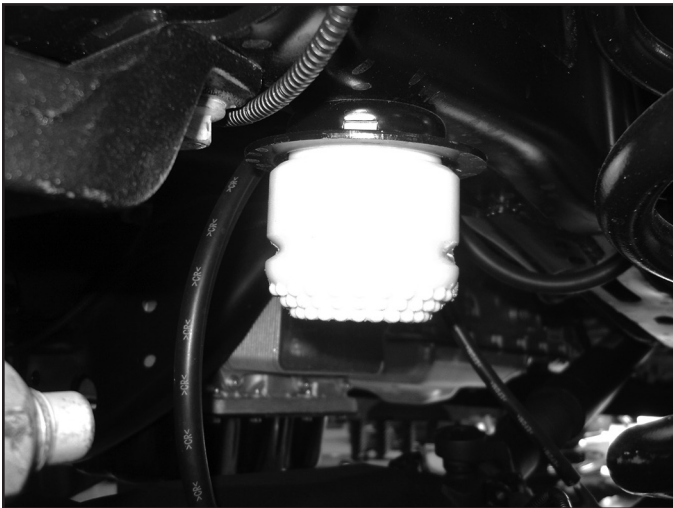
**FIGURE 7**



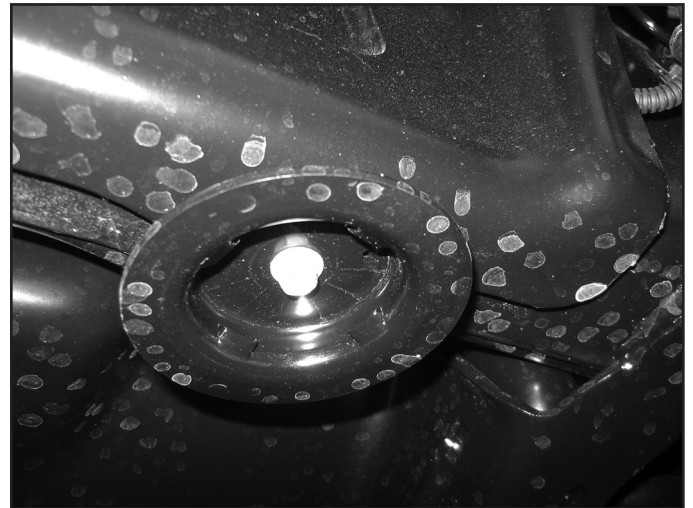
13. Lower the axle and remove the factory coil springs.

14. With coil springs out of the way, remove the factory bump stops, then remove the cup from the frame, discard hardware. (Fig 8a, 8b)

**FIGURE 8A**



**FIGURE 8B**



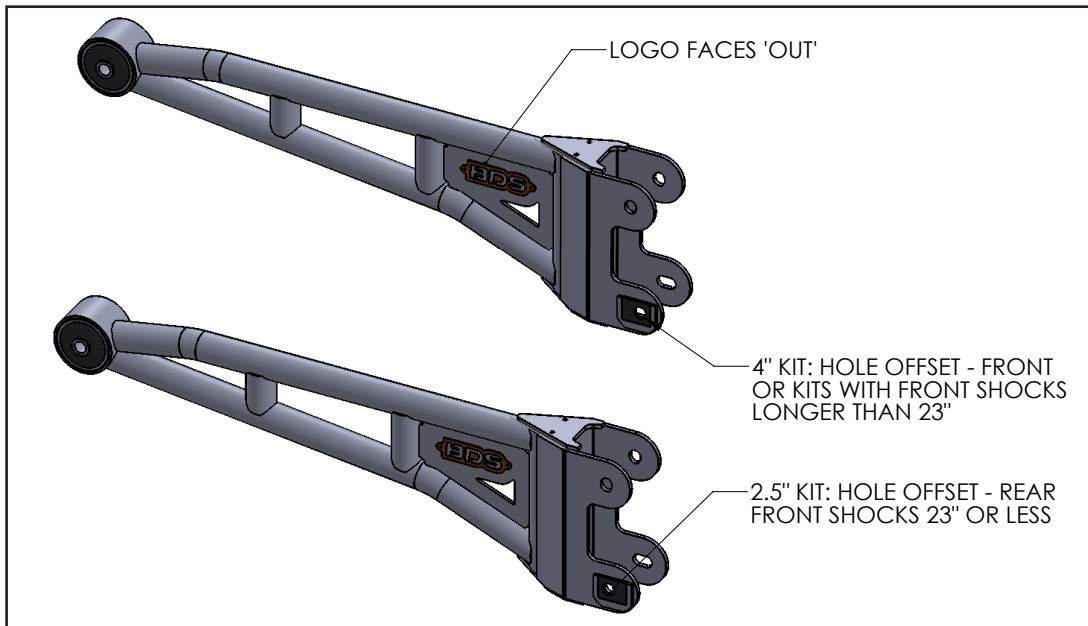
## **RADIUS ARM INSTALLATION**

15. **2023 Model Year Trucks:** Follow specific instructions found in radius arm box kit.

16. Working on one side of the vehicle at a time, remove the stock radius arm and replace with the new one. Install cams into the lower slots with new 18m hardware, and use new 18mm nut on the driver's side upper mount at the axle. (Fig 8) The cam will be offset towards the rear of the vehicle as shown in the bottom image of Figure 9.



**FIGURE 9**



17. Tighten the radius arm hardware at the axle to 222 ft-lbs. Do not tighten the pivot bushing at the frame. (Skip ahead to bump stop installation)

**BUMP STOP INSTALLATION**

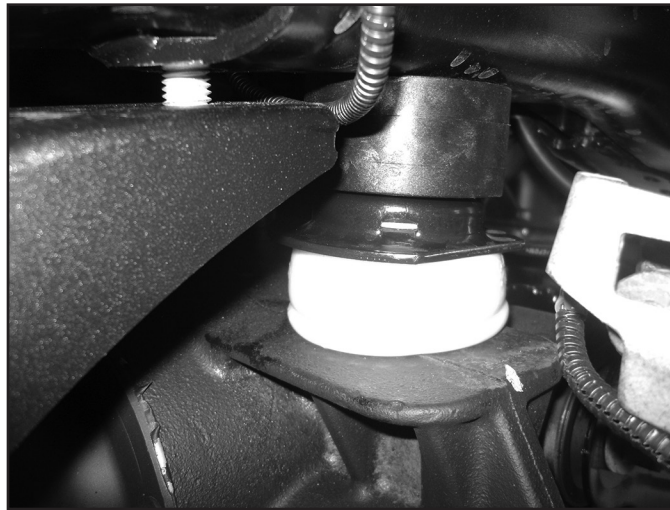
18. Trim off the round edge 1-1/2" from the hole center to have a flat face and coat with paint. This will give extra clearance between the coil spring and cup with the increased wheel travel the kit provides.
19. Install the 1-1/2" bump stop spacer with bump stop cup and 8mm hardware (BP #696). Rotate the bump stop cup so that the newly cut edge is flush with the frame. Note: If installing optional Fox coilovers, the 2" tall bump stop spacer that comes with the coilover mounting brackets will need to be installed. (Fig 10)

**FIGURE 10**



20. Grease the bump stops and reinstall into the factory cups. Raise the axle to get the bump stops to press into the cups. (Fig 11)

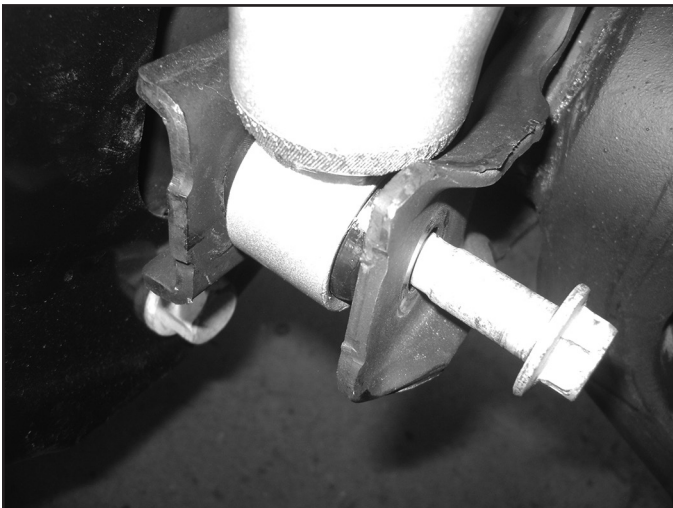
**FIGURE 11**



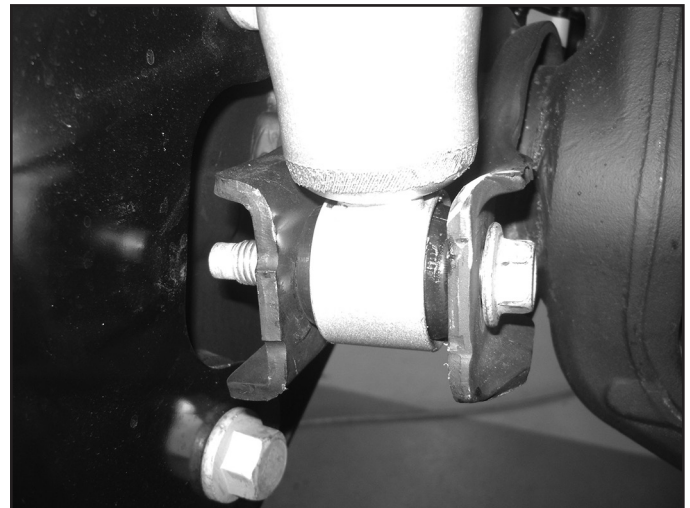
### **COIL AND SHOCK INSTALLATION**

21. If optional coilovers are going to be installed, reference the coilover bracket instruction sheet included with the bracket kit at this time.
22. Grease and install sleeves and bushings into the shocks.
23. BDS (Silver / non-Fox) shocks will require the lower mount to be modified. The sharp, non-formed edge will need to be ground to match the formed profile. Grind this and coat with paint. (Fig 12, 13)

**FIGURE 12**



**FIGURE 13**

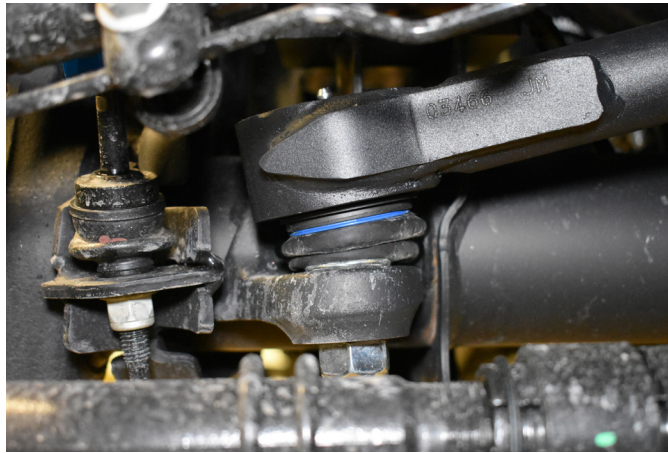


24. Compress the coils slightly by using a hydraulic jack on the axle. Install new shocks with factory lower hardware and stem washers, bushings, and 1/2" fine thread nut on the upper mount. Tighten the upper mount until the bushings begin to swell. Tighten lower mount to 50 ft-lbs.
25. Reattach all brake and vacuum lines to the original locations with the OE mounting hardware and included zip ties. Fox coilovers will have the brackets attach to the lower mounting bracket with included hardware.

### **ADJUSTABLE TRACK BAR BRACKET INSTALLATION**

26. Grease and install bushings and sleeves into track bar. Thread grease zerks into track bar.
27. Adjust the track bar length (eye to eye) to 37 3/8" for 2.5" lift.
28. Attach the track bar to the axle bracket first. Attach with new 18mm nut. Swing the track bar up to the frame end and check for clearance at the axle end between the new track bar gusset and the axle gussets. It may be necessary to grind the axle gussets for clearance. Once clearance is verified, tighten 18mm ball joint nut to 185 ft-lbs (Fig 14).

**FIGURE 14**

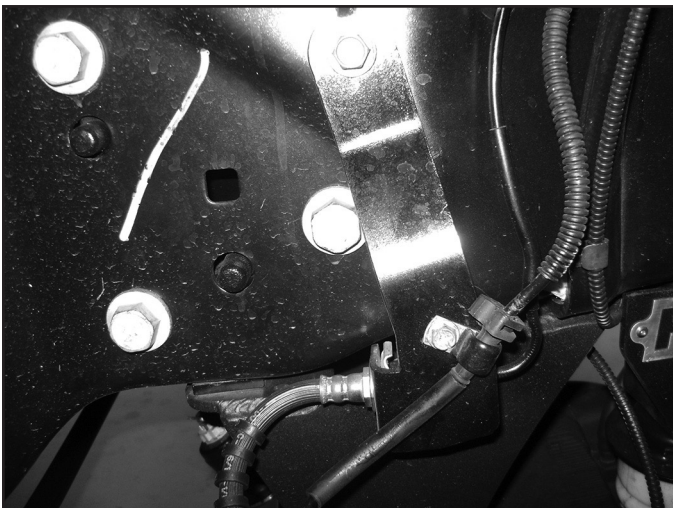


29. Remove (4) allen bolts and apply thread locker to threads, reinstall into track bar.
30. First, tighten pinch bolts on track bar left-to-right at 30 ft-lbs.
31. Repeat left-to-right torque sequence at 30 ft-lbs until all pinch bolts meet 30 ft-lbs specification.

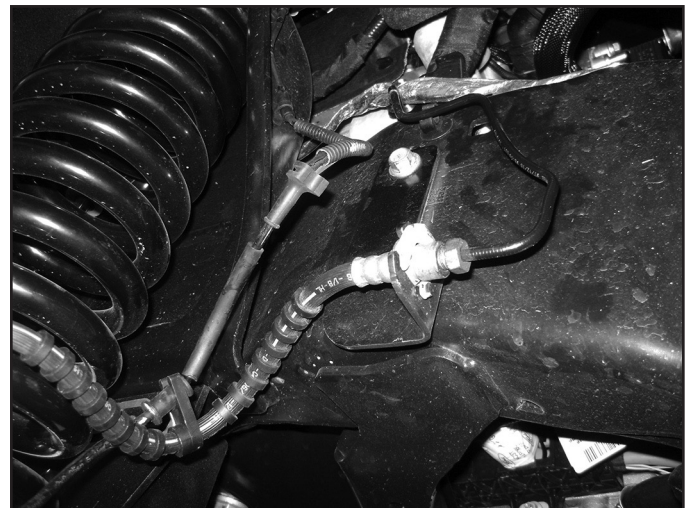
**BRAKELINE / SWAY BAR BRACKET INSTALLATION**

32. Install the new brake line brackets, brackets are side specific. Brake lines will need to be reformed to reach new mounting position. It may be necessary to slightly twist the brake line fittings in relation to the hardline to get adequate clearance to the frame/ wheel and tire. Attach the ABS wire to the driver's side with 1/4" hardware and rubber coated cable clamp (Fig 15a, 15b)

**FIGURE 15A - DRIVER'S**



**FIGURE 15B - PASSENGER'S**



33. Install new sway bar bracket with factory nuts. Slide the brackets as far forward on the vehicle and tighten to 35 ft-lbs.
34. Attach sway bar to the drop bracket with 3/8" hardware (BP #422). Check for sway bar to lower coil mount clearance. Adjust forward / rearward as necessary to have adequate clearance. Tighten to 35 ft-lbs. (Fig 15)

**FIGURE 15**



35. Reinstall wheels and lower vehicle to the ground.
36. Tighten radius arm pivot hardware at the frame to 222 ft-lbs.
37. Check for sway bar, sway bar link clearance to lower coil mount. Adjust sway bar mounting to bracket if necessary.
38. Attach the track bar to the factory bracket with OE hardware. Have an assistant turn the steering wheel to allow hardware installation. Tighten to 405 ft-lbs.
39. Ensure the axle is square under the vehicle. Additional adjustment of the track bar collar may be required. Check the track bar collar to frame crossmember for adequate clearance. A small amount of grinding on the frame cross member lip may be required for clearance to the track bar under compression clearance. (Fig 16)

**FIGURE 16**



40. Adjust steering wheel to center, this will require lengthening of the drag link. Do not drive the vehicle with the steering wheel off-center for extended distances / speeds or a trip to the dealership may be required to reset the computer. Note: if there is less than 1-3/4" of thread engaged in the adjusting collar, the track bar must be shortened to allow for adequate thread engagement of the drag link.
41. Adjust the clamps on the drag link so that they will not hit the sway bar through wheel travel or steering range of motion.
42. Check hardware after 500 miles.

## **REAR INSTALLATION 1" BLOCK KIT**

43. Block the front wheels for safety.
44. Raise the rear of the vehicle and support with jack stands under the frame rails just ahead of the spring hangers.
45. Remove the wheels.
46. Support the axle with a hydraulic jack.
47. Remove the factory shocks. Retain all mounting hardware.
48. Disconnect the passenger's side spring u-bolts. (Fig 17)

**FIGURE 17**



49. Remove the factory lift block. It will be reinstalled later.
50. Place a C-clamp on either side of the center pin, clamping all leaves together. Loosen the top center pin nut and lower the axle enough to remove the factory center pin.
51. Place the provided 1" block on the bottom of the leaf pack and insert the new center pin first through the block, then through the leaf pack. Tighten the nut to 20 ft-lbs. Remove the C-Clamps.
52. Replace the OE block and raise the axle to engage the block spring alignment pin. Fasten the entire assembly with the provided u-bolts, high nuts and washers. Snug but do not torque the u-bolts at this time.
53. Repeat block installation of the driver's side. Take care not to over extend the brake lines.
54. Install the new shocks with the original mounting hardware. Tighten to 55 ft-lbs.
55. Install wheels and lower the vehicle to the ground.
56. With the weight of the vehicle on the axle, torque the u-bolts to 130-150 ft-lbs. The u-bolts can be trimmed now to the desired length.
57. Torque lug nuts to factory specification.
58. Recheck all hardware for proper torque, check again after 500 miles and at regularly scheduled maintenance intervals.



### **WE WANT TO SEE YOUR RIDE!**

Grab photos of your BDS-equipped truck in action and send them in for a chance to be featured. Send it in to our Bad Ass Rides customer gallery at [bds-suspension.com/bar](http://bds-suspension.com/bar) and post them on the BDS Fan Page on Facebook at [facebook.com/BDSSuspensions](https://facebook.com/BDSSuspensions). Don't forget about your BDS swag! BDS offers t-shirts, hoodies, decals and more available on the BDS website or through your local BDS distributor.

---

## **TIME TO HAVE SOME FUN**

**Thank you for choosing BDS Suspension.**

For questions, technical support and warranty issues relating to this BDS Suspension product, please contact your distributor/installer before contacting BDS Suspension directly.