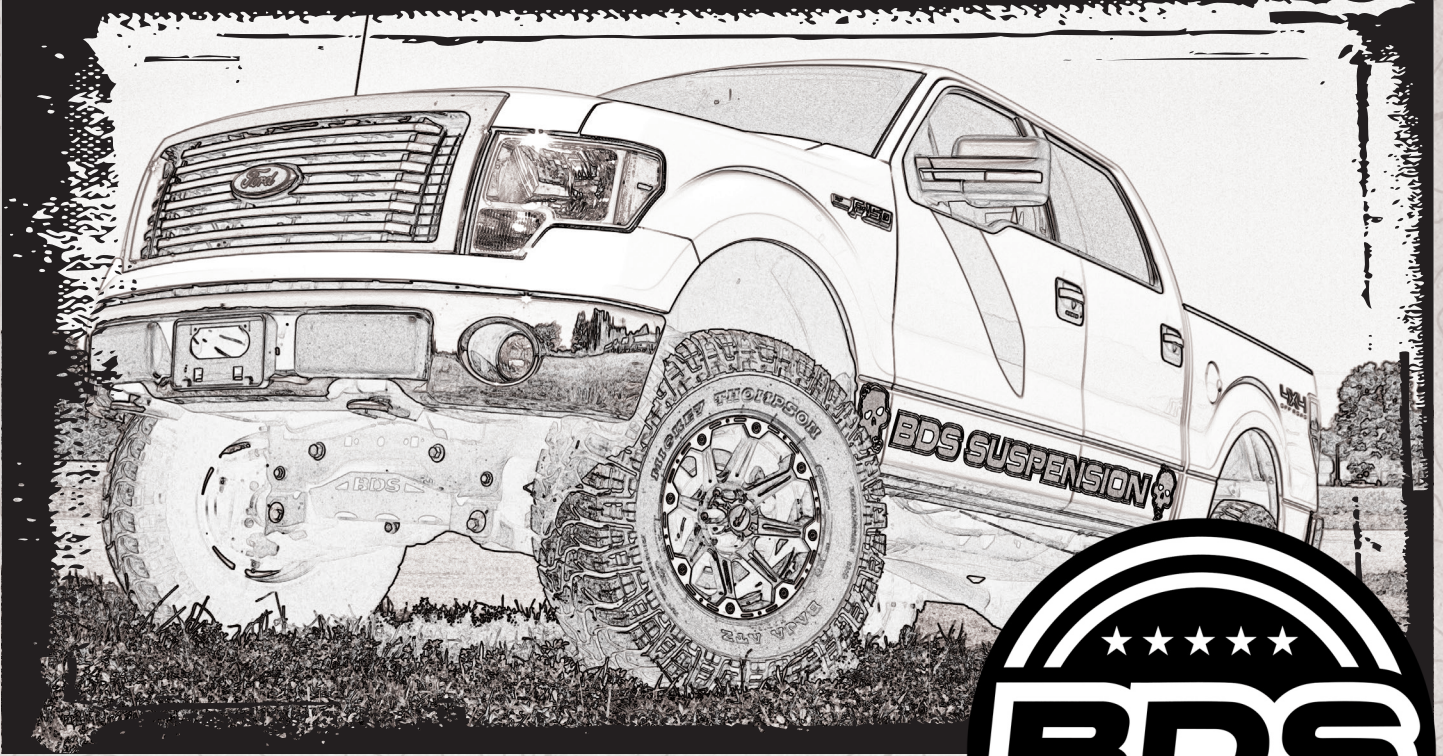
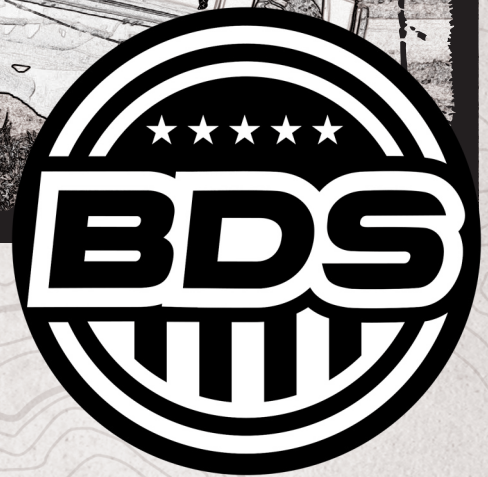


INSTALLATION GUIDE



Part#: 023622



HARDCORE LIMITED LIFETIME WARRANTY

4" & 6" Suspension System

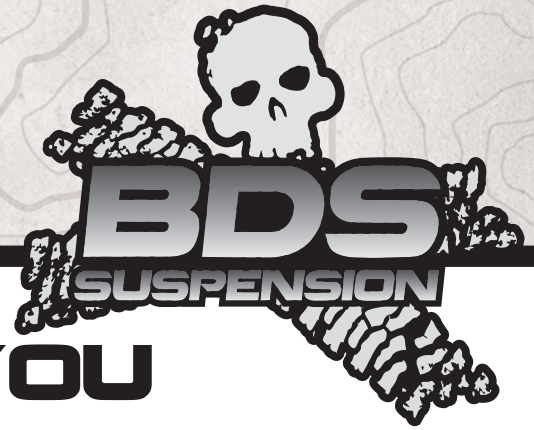
Ford F150 4WD | 2009-2014

Rev. 040422

491 W. Garfield Ave., Coldwater, MI 49036 • Phone: 517-279-2135

E-mail: tech@bds-suspension.com

Read And Understand All Instructions And Warnings Prior To Installation Of System And Operation Of Vehicle.



THANK YOU

Your truck is about to be fitted with the best suspension system on the market today. That means you will be driving the baddest looking truck in the neighborhood, and you'll have the warranty to ensure that it stays that way for years to come. Thank you for choosing BDS Suspension!

BEFORE YOU START

BDS Suspension Co. recommends this system be installed by a professional technician. In addition to these instructions, professional knowledge of disassembly/ reassembly procedures and post installation checks must be known.

FOR YOUR SAFETY

Certain BDS Suspension products are intended to improve off-road performance. Modifying your vehicle for off-road use may result in the vehicle handling differently than a factory equipped vehicle. Extreme care must be used to prevent loss of control or vehicle rollover. Failure to drive your modified vehicle safely may result in serious injury or death. BDS Suspension Co. does not recommend the combined use of suspension lifts, body lifts, or other lifting devices. You should never operate your modified vehicle under the influence of alcohol or drugs. Always drive your modified vehicle at reduced speeds to ensure your ability to control your vehicle under all driving conditions. Always wear your seat belt.

BEFORE INSTALLATION

- Special literature required: OE Service Manual for model/year of vehicle. Refer to manual for proper disassembly/reassembly procedures of OE and related components.
- Adhere to recommendations when replacement fasteners, retainers and keepers are called out in the OE manual.
- Larger rim and tire combinations may increase leverage on suspension, steering, and related components. When selecting combinations larger than OE, consider the additional stress you could be inducing on the OE and related components.
- Post suspension system vehicles may experience drive line vibrations. Angles may require tuning, slider on shaft may require replacement, shafts may need to be lengthened or trued, and U-joints may need to be replaced.
- Secure and properly block vehicle prior to installation of BDS Suspension components. Always wear safety glasses when using power tools.
- If installation is to be performed without a hoist, BDS Suspension Co. recommends rear alterations first.
- Due to payload options and initial ride height variances, the amount of lift is a base figure. Final ride height dimensions may vary in accordance to original vehicle attitude. Always measure the attitude prior to beginning installation.

BEFORE YOU DRIVE

Check all fasteners for proper torque. Check to ensure for adequate clearance between all rotating, mobile, fixed, and heated members. Verify clearance between exhaust and brake lines, fuel lines, fuel tank, floor boards and wiring harness. Check steering gear for clearance. Test and inspect brake system.



Visit 560plus.com for more information.

TRACTION CONTROL

In an effort to reduce the risk of rollover crashes the National Highway Traffic Safety Administration (NHTSA) established the Federal Motor Vehicle Safety Standard (FMVSS) No. 126 requiring all new passenger vehicles under 10,000 lbs GVWR include an electronic stability control (ESC) system as standard equipment. Effective August 2012 this law requires aftermarket products to be compliant with these same standards.



TIRES AND WHEELS

FITMENT GUIDE

6" Lift:

37x12.50 on 18x9 with 5" backspacing*
37x12.50 on 20x9 with 5.5" backspacing

4" Lift:

35x12.50 on 18x9 with 5" backspacing*
35x12.50 on 20x9 with 5.5" backspacing

*See troubleshooting notes



Perform steering sweep to ensure front brake hoses have adequate slack and do not contact any rotating, mobile or heated members. Inspect rear brake hoses at full extension for adequate slack. Failure to perform hose check/ replacement may result in component failure. Longer replacement hoses, if needed can be purchased from a local parts supplier.

Perform head light check and adjustment.

Re-torque all fasteners after 500 miles. Always inspect fasteners and components during routine servicing.

CONTENTS OF YOUR KIT

2009-13 6" KIT



4" KIT



023626 Box Kit

Part #	Qty	Description
02067	1	Steering Knuckle - Pass

023625 Box Kit

Part #	Qty	Description
02065	1	Steering Knuckle - Drv

023622

Part #	Qty	Description
02001	8	Cam Washer
02002	2	18mm x 150 Cam Bolt
02074	2	18mm x 170 Cam Bolt
N18MPT	4	18mm Prevailing Torque Nut
02068B	1	Front Crossmember
02069B	1	Rear Crossmember
02070B	2	Sway Bar Drop
02078	1	Front Driveshaft Spacer
02075	1	Weld In Gusset
01602	2	Strap w/Stud

023623

Part #	Qty	Description
02071B	2	Diff Drop Bracket
02072B	1	Diff Support Bracket
02073B	1	Diff Skid Plate
02076B	1	Diff Supt Brkt - DS
400408-10	1	Fuel Vent Hose
925	1	Bolt Pack - Drive Shaft Spacer
	6	10mm x 100mm bolt - SHCS
772	1	Bolt Pack - Differential Hardware
	3	9/16"-12 x 4" bolt
	5	9/16"-12 x 1-1/4" bolt
	16	9/16" SAE Thru hardened washer
	8	9/16"-12 Prevailing torque nut
	4	7/16"-14 x 1-1/4" bolt
	8	7/16" SAE Thru hardened washer
	4	7/16"-14 prevailing torque nut
773	1	Bolt Pack
	2	18mm x 150mm bolt
	4	3/4" SAE Washer
	2	18mm Prevailing torque nut
	2	1/4"-20 Prevailing torque nut
	4	1/4" USS flat washer
	2	6mm x 18mm bolt
	4	1/2"-13 x 1-1/4" button head bolt
	4	1/2" SAE Washer
	4	3/8"-16 x 1-1/4" bolt
	8	3/8" SAE Thru hardened washer
	4	3/8"-16 Prevailing torque nut

023605 Box Kit (2014 6" Only)

Part #	Qty	Description
02725	2	Strut Spacer
400408-10	1	Fuel Vent Hose - Not Used
629	1	Bolt Pack - Not Used
769	1	Bolt Pack
	6	7/16"-14 nylock nut clear zinc
	6	3/8" USS flat washer clear zinc

98163 Box kit (2009-13 6" Only)

Part #	Qty	Description
P01484	2	Strut Parts Pack
5398	2	6" Strut
N12MF	2	12mm Flanged Nut

023405/023425 Box Kit (4" Only)

Part #	Qty	Description
02429	1	4" Offset Rear Block - Drv.
02430	1	4" Offset Rear Block - Pass.
963181212QB	4	9/16 x 3-1/8 x 12-1/2 Square U-bolt
W96S-B	8	9/16 SAE Flat Washer
N96FH-B	8	9/16 Fine High Nut
02079B	1	E-Brake Bracket
01716	1	Offset Brake Line Drop Bracket
02427	2	Strut Spacer 4" - DRV & PASS (023425 Only)
02427	1	Strut Spacer 4" - DRV (023405 only)
02428	1	Strut Spacer 4" - PASS (023405 only)
605	1	Bolt Pack - E-Brake Bracket
	2	7/16"-14 x 1 1/4" bolt
	2	7/16"-14 prevailing torque nut
	4	7/16" SAE washer
768	1	Bolt Pack - Rear Brakeline Bracket
	2	1/4"-20 x 3/4" Bolt
	2	1/4"-20 nylock nut
	4	1/4" USS flat washer
769	1	Bolt Pack - Strut Spacers
	6	7/16"-14 nylock nut
	6	3/8" USS flat washer

013529 Rear Box kit (6" Only)

Part #	Qty	Description
01716	1	Offset Brake Line Drop Bracket
02085	2	5" Offset Rear Block
02079B	1	E-Brake Bracket - black
02086	2	Lower Spring Plate
02087B	2	Upper Spring Plate
774	1	Bolt Pack - Rear Block Kit
	2	1/2"-20 x 3-1/2" bolt flat SHCS
	2	1/2"-20 nut
	2	7/16"-14 x 1-1/4" bolt
	4	7/16" SAE washer
	2	7/16"-14 Prevailing torque nut
	1	1/4"-20 prevailing torque nut
	1	1/4" USS washer
120400FCP	2	1/2 x 4 Pin w/Nut
963181212QB	4	9/16 x 3-1/8 x 12-1/2 Square U-bolt
W96S-B	8	9/16 SAE Washer
N96FH-B	8	9/16 Fine High Nut
768	1	Bolt Pack - Rear Brakeline Bracket
	2	1/4"-20 x 3/4" Bolt
	2	1/4"-20 nylock nut
	4	1/4" USS flat washer

SPECIAL TOOLS

6" kits require high quality strut compressor
 Requires frame bracket modification and welding
 Reciprocating saw or equivalent

TROUBLESHOOTING INFORMATION FOR YOUR VEHICLE

- 18" wheels with 5-5.5" backspacing should be test fit prior to mounting the tire to ensure proper clearance to the steering knuckle/tie rod.
- 18" or larger diameter wheels required. Stock 17" and 18" wheels cannot be re-installed. Stock 20" wheels can be used with up to a 305/60R20 tire.
- E-brake bracket required for factory powersteps (123018)
- Models with 2-piece rear driveshaft may require carrier bearing shim kit 123402
- Block kits replace factory 1-1/4" block. For a level to tail low appearance use 023415 with kit 598H or use 013429 with 573H.
- Will fit EcoBoost models.

TECH TIPS

INSTALLATION INSTRUCTIONS

FRONT INSTALLATION

1. Park the vehicle on a clean, flat surface and block the rear wheels for safety.
2. Measure from the center of the wheel up to the bottom edge of the wheel opening and record below:

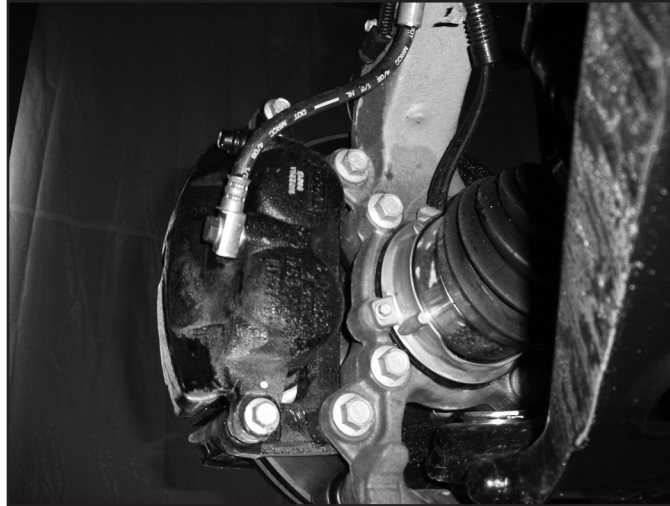
LF _____ RF _____ LR _____ RR _____

3. Raise the front of the vehicle and support with jack stands at each frame rail behind the lower control arms.
4. Remove the front wheels.

! Caution 2011 and newer models equipped with EPAS (Electronic Power Assist Steering), disconnect the power steering control module connector to avoid arcing of the contacts in the internal power relay from a hammer blow or impact wrench.

5. Remove the brake caliper anchor bracket bolts and remove the caliper from the knuckle (Fig 1). Hang the caliper out of the way. Do not let the caliper hang by the brake hoses.

FIGURE 1



6. Remove the brake rotor and set aside.
7. Disconnect the ABS and hub vacuum lines from the retaining clips. Disconnect the brakeline bracket from the frame rail. Disconnect the ABS line from the inner fender well, and disconnect the clip (Fig 2a / b).

FIGURE 2A

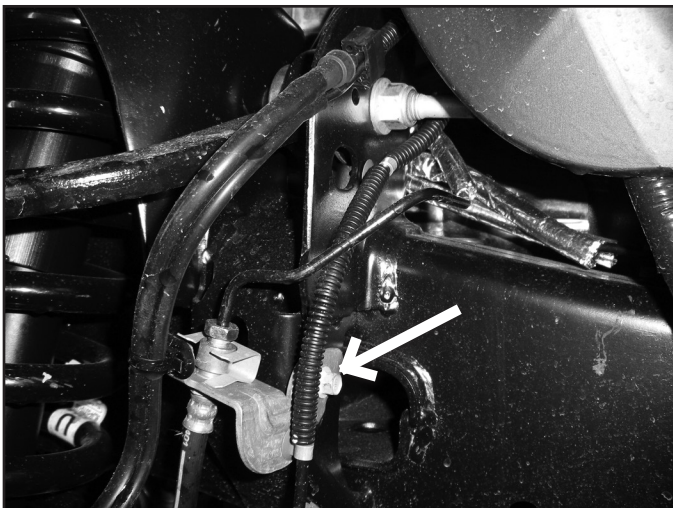


FIGURE 2B



8. Disconnect the hub vacuum line from the hub (Fig 3).
9. Disconnect the tie rod ends from the steering knuckles (Fig 4). Remove and retain the mounting nuts. Strike the steering knuckle near the tie rod end to dislodge the end. Take care not to strike the tie rod end.

FIGURE 3

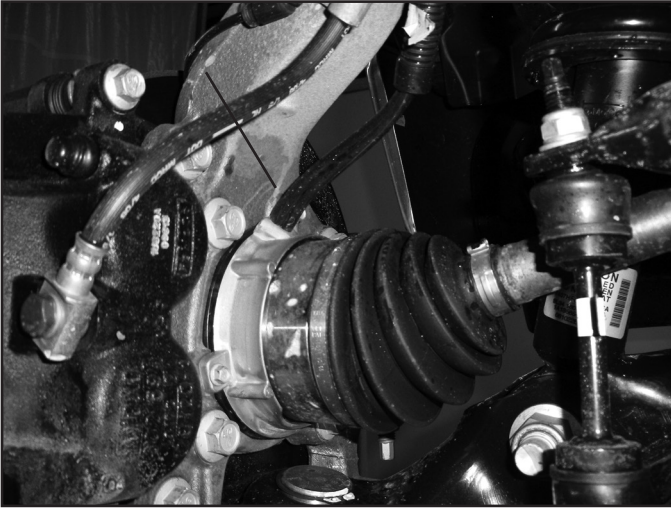


FIGURE 4



10. Disconnect the sway bar links from the sway bar (Fig 5 a). Retain hardware. The sway bar links do not need to be removed from the lower control arms.
11. Remove the four sway bar mounting nuts and remove the sway bar from the vehicle (Fig 5b). Retain hardware

FIGURE 5A



FIGURE 5B



12. Carefully remove the hub dust cap to expose the axle shaft nut (Fig 6 a / b). Remove the nut. Retain the cap and nut, they will be reinstalled later.

FIGURE 6A

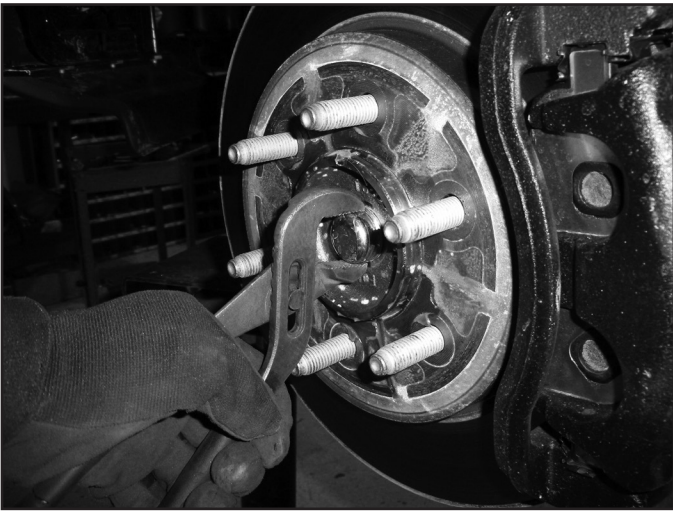
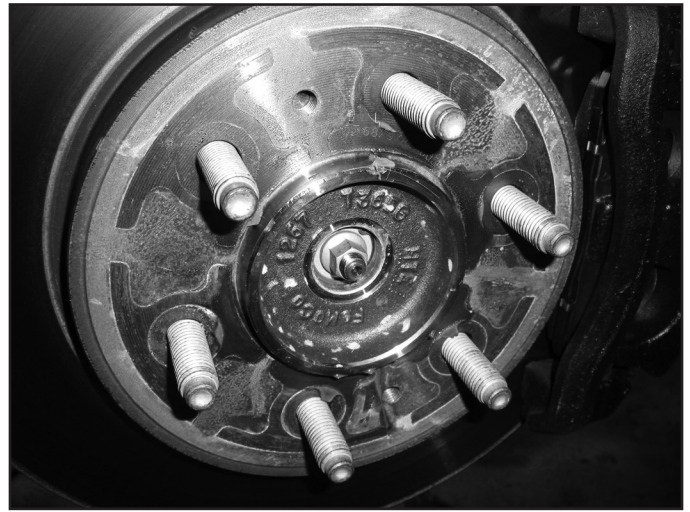
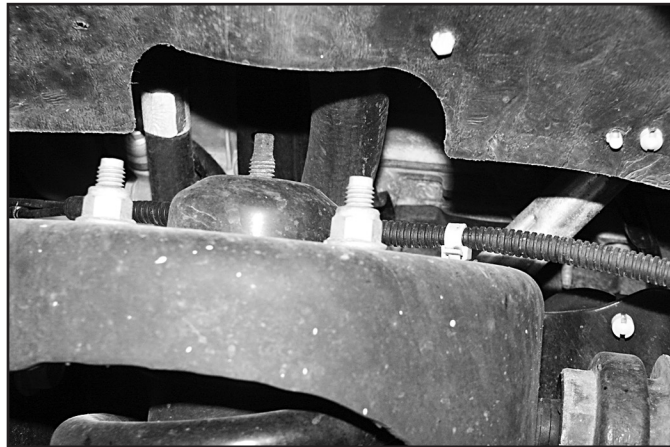


FIGURE 6B



13. Loosen but do not remove the three strut assembly mounting nuts at the frame (Fig 7). Do not loosen the middle strut nut.

FIG 7



14. Loosen and remove the nut from the strut-to-lower control arm mounting bolt (Fig 8). Leave the bolt in place at this time. Retain the mounting nut.
15. Remove the upper and lower ball joint nuts (Fig 9) and reinstall a few turns.

FIGURE 8

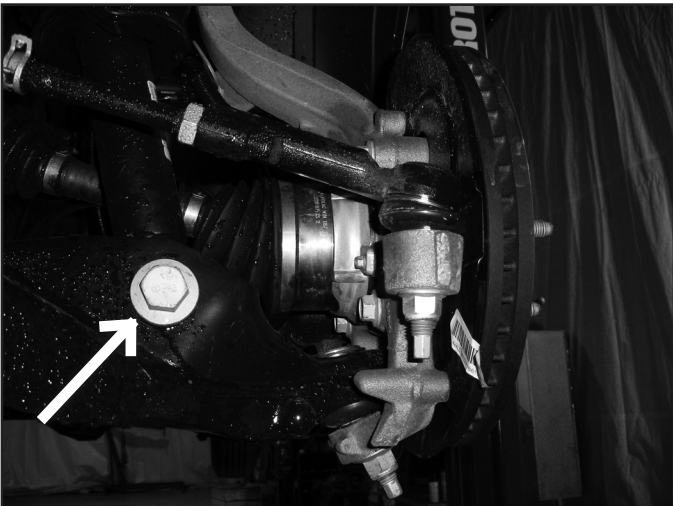


FIGURE 9



16. Strike the knuckle near the upper and lower ball joints to dislodge the joints from the knuckle.
17. Remove the upper ball joint and the strut-to-lower control arm bolt. Swing the knuckle/lower control arm down to remove the CV shaft from the hub. Retain ball joint nut and strut bolt.
18. Remove the lower ball joint nut and remove the knuckle from the vehicle. Retain hardware.
19. Remove the lower control arm mounting bolts and remove the lower control arm from the vehicle. Retain hardware.
20. Mark the struts to distinguish between driver's and passenger's. In addition, mark the relationship between the coil and the lower strut mounting hole and finally the top plate and the rubber coil seat.
21. Remove the three strut assembly mounting nuts at the frame and remove the strut assembly from the vehicle.
22. Take a wire brush and remove the material from the threads of the four bolts that attach the OE rear crossmember. Spray threads with lubricant and remove the bolts and crossmember from the vehicle. Discard the crossmember and hardware. (Fig 10)
23. Remove the driveshaft mounting bolts and disconnect the driveshaft from the differential (Fig 11). Allow the driveshaft to rest out of the way.

FIGURE 10

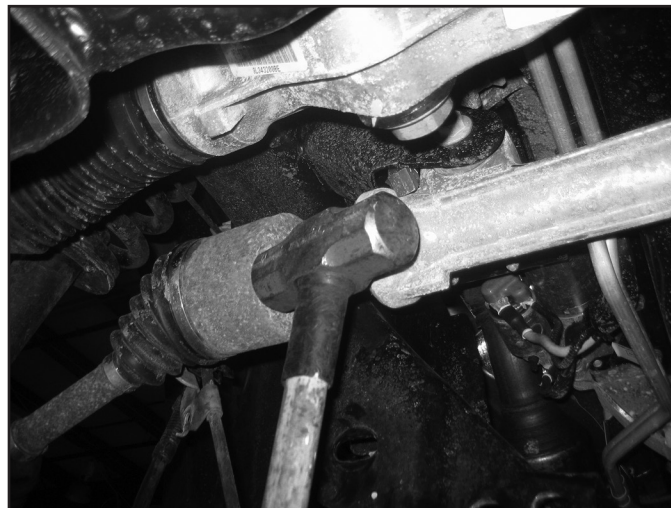


FIGURE 11



24. Remove the passenger's side CV only. Strike the shaft with a hammer to dislodge it from the splines. This will make handling the differential much easier. (Fig 12)

FIGURE 12



25. Support the front differential with an appropriate jack. Loosen all of the hardware and slide the differential all the way to the passenger's side. Orientate the joint at the steering rack so there is the most possible clearance to remove the front driver's side bolt. Remove this bolt first. Disconnect the differential breather hose from the differential housing. Remove the rear driver's side and one passenger's side differential mounting bolts (Fig 13a, 13b) and remove the differential from the vehicle.

FIGURE 13A

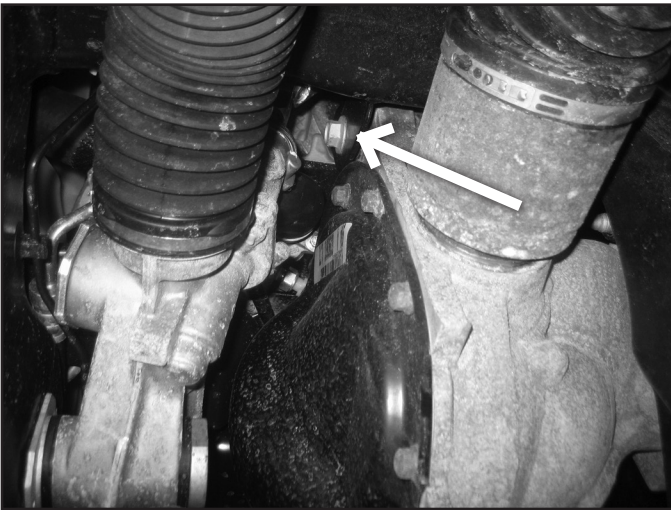


FIGURE 13B



26. Pull down on the differential breather hose to gain additional slack.
27. The driver's side rear lower control arm frame pocket must be modified to provide clearance for the differential in its relocated position. On the front side measure from the inside edge of the slot $5/8$ " (Fig 14a). Make a vertical cut line at the mark. Measure down $1-3/4$ " from the center of the slot, make a horizontal cut line.
28. On the back side measure from the inside edge of the slot $1-7/8$ " and mark (Fig 14b). Make a vertical cut line at the mark. Measure down $2-1/2$ " and make a horizontal cut line.

FIGURE 14A

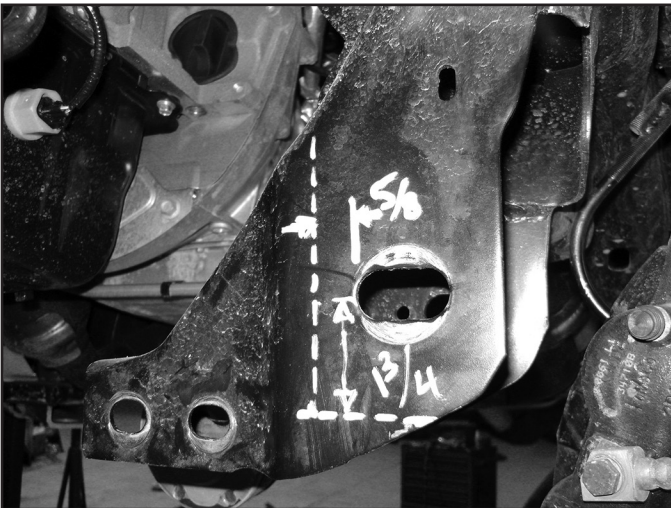
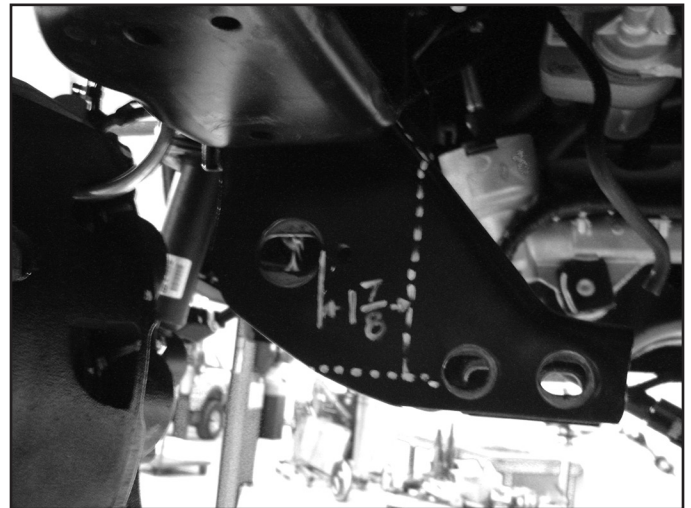


FIGURE 14B



29. Connect the front cut line straight to the back face. This will require trimming minor trimming on the factory differential mount tab. (Fig 14c, 14d)

FIGURE 14C

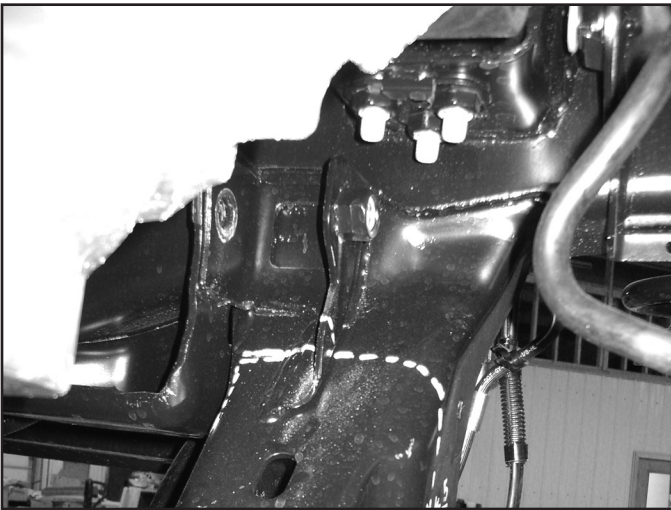


FIGURE 14D



30. Trim the shown area from the vehicle. (Fig 15a, 15b)

FIGURE 15A



FIGURE 15B

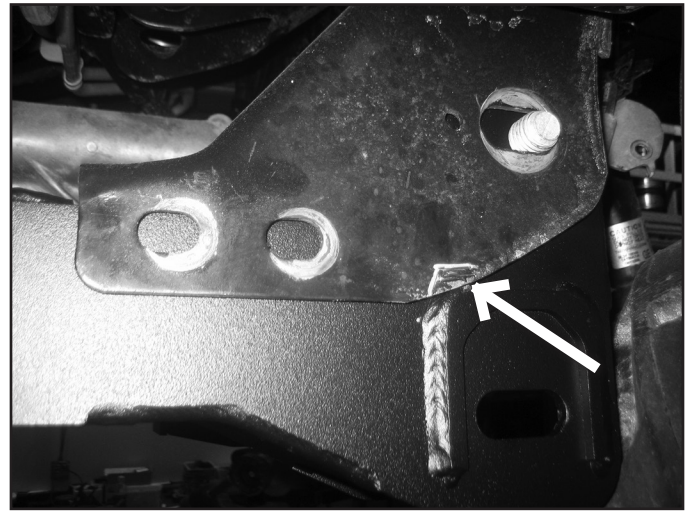


31. The passenger's side control arm pocket must also be trimmed. Measure down 1-3/4" and make a horizontal cut line. The cut will stop where the vertical offset begins. (Fig 16)
32. Install the rear crossmember and check the passenger's backside pocket for necessary clearance. A small amount of material may need to be removed. (Fig 16b)

FIGURE 16A

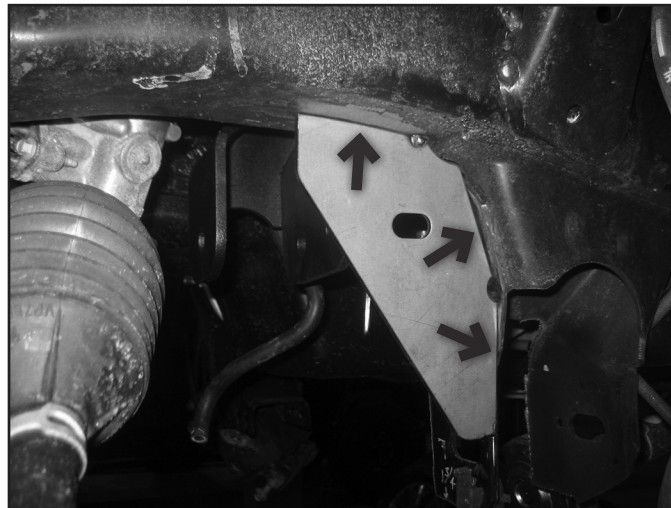


FIGURE 16B



33. With the crossmember installed mark the differential hole on the factory control arm bracket. Remove the crossmember and drill a 5/8" hole at the mark, for easiest access drill the hole from front to back, a step drill is recommended for this step.
34. Remove the paint from the driver's side rear control arm pocket. Place the weld in plate so that it is aligned with the outside edge of the bracket and the plate is vertical. Note: Newer models will require the factory mount that wraps to the bottom side of the frame to be trimmed for clearance. Tack weld in place. Note: If a welder is unavailable, this step may be performed after the entire installation is completed, it is safe to drive the vehicle to a place that is capable of performing the welding required. (Fig 17)

FIGURE 17



35. Temporarily install the differential drop bracket on the driver's side with OE bolt. Place the driver's side differential support bracket (L-shaped bracket) up between the weld in plate and differential drop. If the slots align, remove differential drop bracket and L-shaped bracket. Weld the outside of the plate in the 3 places shown. (Fig 17)
36. Allow the metal to cool and coat with paint.
37. Attach the differential relocation brackets (02071) to the differential with 9/16" hardware, do not tighten at this time. Run the hardware from front to rear. Raise the differential with the brackets attached into the vehicle by aligning the differential mounts in the two front drop brackets attach to the frame with OE hardware. (Fig 18)

FIGURE 18



38. Install the new rear crossmember (02069) in the rear lower control arm frame pockets. Attach the rear crossmember with the sway bar drop brackets with new 18mm bolts and washers. Run bolts from rear to front (Fig 22a). Leave hardware loose. Ensure the hole that was drilled in the frame pocket lines up to the differential mounting hole in the bracket. (Fig 19a). Do not tighten hardware at this time.
39. Fasten the differential to the rear crossmember (Fig 19b) with a 9/16" bolt, washers, and nut (BP #772). Run the bolt from front to rear. Leave hardware loose.

FIGURE 19A

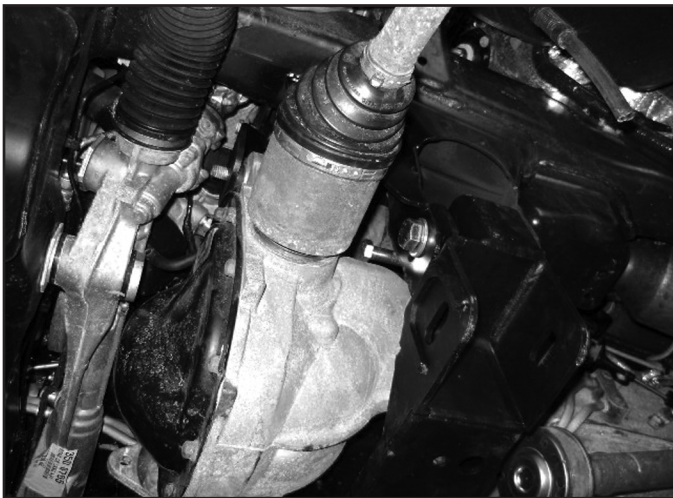
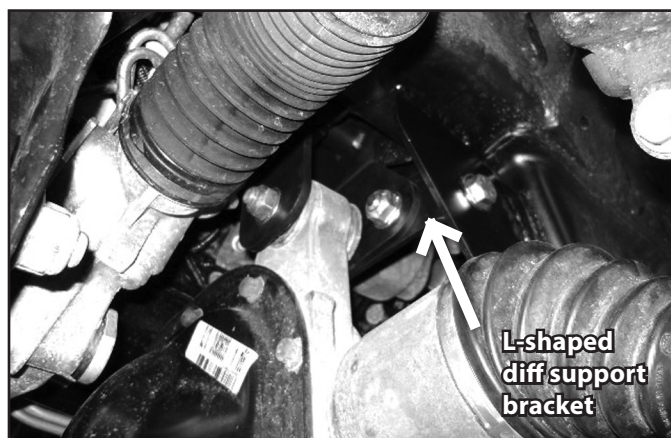


FIGURE 19B



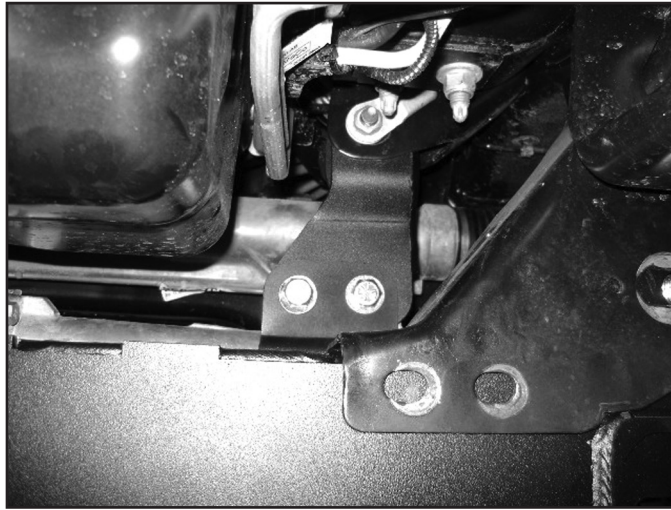
40. Fasten the L-shaped support bracket to the rear of diff drop bracket. Fasten to the passenger's side bracket with the same size hardware (BP #772). Attach all hardware from the front to rear. Leave all hardware loose at this time. (Fig 20a).

FIGURE 20A



41. Install the offset differential support bracket to the backside of the passenger's side differential bracket using the hardware that was just installed and 9/16" x 1-1/4" hardware to the BDS crossmember. Leave hardware loose. (Fig 20b)

FIGURE 20B



42. Torque all of the differential mounting hardware to 95 ft-lbs (10 total). Attach the differential breather tube. On 2014+ models - Remove the differential breather elbow from the plastic line and replace it with the provided hose and attach it to the differential.
43. Install the front crossmember in the front lower control arm pockets and fasten with the OE lower control arm hardware. Leave hardware loose.
44. Install the lower control arms in the new cross members and fasten with the provided 18mm cam bolts, cam washers and 18mm nuts. Run the front bolts from front to rear and leave loose. Run the rear bolts from rear to front. The main body of the cam will be 'up' in the cam slot
45. Install the provided differential skid plate to the front and rear cross members with 1/2" x 1-1/4" button head bolts and 1/2" SAE washers (BP #773) into the weld nuts in the cross members (Fig 21). Leave hardware loose.

FIGURE 21



46. Attach the sway bar drop brackets with new 3/8" x 1-1/4" bolts, washers and nuts. Run hardware from bottom - up, snug but do not tighten at this time.



Tip Use a ratchet extension through the lower slots to access the hardware (Fig 22a, 22b)

FIGURE 22A

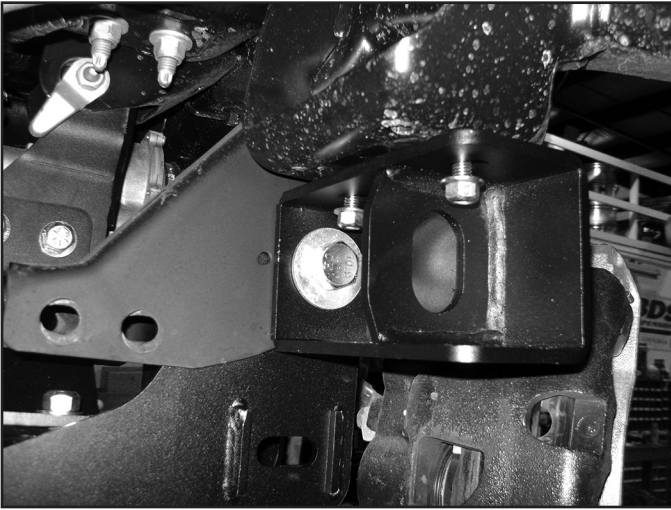


FIGURE 22B



47. With the lower control arms installed torque the four crossmember mounting bolts to 222 ft-lbs. Ensure that the front crossmember is centered in the vehicle. Torque the differential skid plate bolts to 65 ft-lbs. Tighten sway bar drop hardware to 35 ft-lbs.
48. Reinstall the passengers side CV.

4" KITS SKIP TO STEPS 56-58, 2009-13 6" KITS: USE STEPS 49-54, 2014 6" KITS STEPS 55 & 58, FOX COILOVERS SKIP TO STEP 59

4" & 6" PERFORMANCE SERIES 2.0 SNAP RING COILOVERS FOLLOW INSTRUCTIONS INCLUDED WITH COILOVERS SKIP TO STEP 60

49. (6" kit only 2009-13 models) Place the strut assembly into a high quality spring compressor.

! Caution *Only use a high quality wall mounted spring compressor! (Fig 23)*

FIGURE 23



50. (6" kit only 2009-13 models) Compress the coil following spring compressor instructions and remove the strut nut.
51. (6" kit only 2009-13 models) Remove the top cap and upper spring isolator.
52. (6" kit only 2009-13 models) Turn the new strut rod counterclockwise to release the rod and allow it to extend. Install the new lower coil seat and bump stop onto the replacement strut.
53. (6" kit only 2009-13 models) Align marks on coil to the upper mount and also with the lower mounting hole. Install the new strut in the coil spring and factory top cap. Fasten the strut rod with the new provided 12mm flange nut. Torque strut rod nut to 40 ft-lbs.
54. (6" kit only 2009-13 models) Install the strut assemblies in the appropriate sides on the vehicle with OE hardware, leave hardware loose at this time. Skip ahead to step 60.
55. (6" kit only 2014 models) The same strut spacer is used on both sides. Place the 02725 strut spacer on each strut and attach with the factory hardware. Tighten to 40 ft-lbs.
56. (4" kit only 2014 models) The same strut spacer is used on both sides. Place the 02427 strut spacer on each strut and attach with the factory hardware. The strut spacers are located in the rear box kit. Tighten to 40 ft-lbs.
57. (4" kit only 2009-13 models) Place the top spacer (02427 = Drv side, 02428 = pass side) on the correct side strut. Attach with the factory hardware and tighten to 40 ft-lbs.
58. (4-6" struts spacer kits - all models) Install the strut and spacer assembly into the vehicle. Attach to upper mount with new 7/16" nuts and washers (bolt pack #769). Leave hardware loose at this time. (Fig 23b). Skip ahead to step 60.

FIGURE 23B



59. Install coilovers as shown, coilovers are labeled which side for installation. Mount the reservoir to the top side of the upper strut mount, run the hose below the upper control arm, and attach with included hardware and bracket. 2014 models may require the upper hat to be removed and rotated 180 degrees on the passenger's side only. Tighten 3/8" hardware to 35 ft-lbs. Check hose for clearance, adjust as necessary. Coilovers are preset for 4" or 6" of lift (additional adjustment may be required to get the desired final height). (Fig 23c) **Note: 2014 models will use the provided 12mm bolts and washers at the bar pin mount on the lower A-arm.**

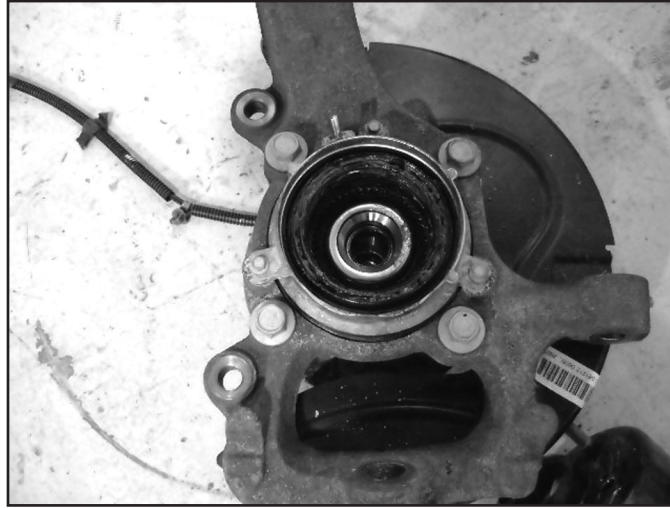
FIGURE 23C



4" AND 6" - ALL KITS

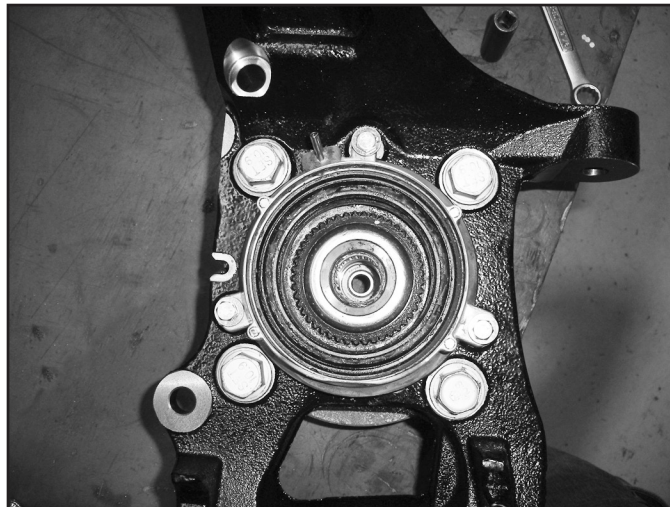
60. Remove the four hub bolts from the knuckle and remove the hub from the knuckle (Fig 24). Inspect mounting surface of the hub assembly and clean any dirt or corrosion off as necessary.

FIGURE 24



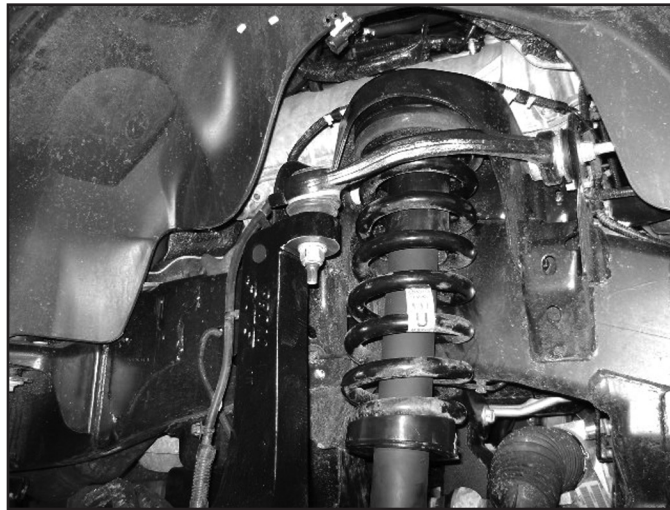
61. Install the hub into the corresponding new BDS knuckle (drv- 02065, pass- 02067) and fasten with the OE bolts. The ABS wire will be located at the 'top' of the hub. Use thread locker on the bolt threads and torque to 148 ft-lbs.
62. Remove the three 6mm bolts mounting the vacuum hub assembly to the inside of the OE knuckle (Fig 25). Transfer the vacuum assembly over to the new knuckle. Make sure the vacuum port is pointing towards the top. Attach with the OE bolts, tighten bolts securely (about 5-7 ft-lbs).

FIGURE 25



63. Install the dust shield with the factory 6mm bolts, tighten bolts securely (about 5-7 ft-lbs). Route the ABS cable behind the dust shield.
64. Install the new knuckle assembly on the lower control arm ball joint and loosely fasten with the original nut. Install the CV shaft in the hub, swing the whole assembly up and attach the lower control arm to the strut with the original hardware. Leave all hardware loose.
65. Attach the upper control arm to the knuckle with the original nut. Torque the upper ball joint to 85 ft-lbs and the lower ball joint to 111 ft-lbs. (Fig 26)

FIGURE 26



66. Torque the upper strut nuts to 35 ft-lbs. The lower bolt will be tightened later with the weight of the vehicle on the suspension.
67. Fasten the CV shaft to the hub with the original nut. Make sure the splines are engaged properly in the vacuum actuated section of the hub. The hub should have a very minor amount of rotational play with the CV shaft if installed properly, torque to 20 ft-lbs. Reinstall the dust cap.
68. Install tie rod from top-down. Torque to 111 ft-lbs.
69. Install the brake rotor and caliper to the knuckle with OE bolts. Torque to 148 ft-lbs.
70. Install the brake line relocation brackets (01602) at the frame. Attach with OE hardware to frame, attach brakeline retaining clip with 1/4" nut and washer to the relocation bracket. Tighten to 15 ft-lbs.
71. Attach the ABS line to the connector at the inner fender and the vacuum line to the hub. Route the lines similar to the factory setup down to the side of the knuckle. Attach the ABS wire with the factory 6mm bolt to the side of the knuckle. Attach the brakeline with a new 6mm x 18mm bolt with 1/4" washer to the side of the knuckle (BP# 773), the brakeline locating tab will go into the unthreaded hole. (Fig 28A, B).

FIGURE 28A



FIGURE 28B



72. Install the sway bar to the new sway bar drop brackets with 7/16" x 1-1/4" bolts, nuts and 7/16" SAE washers (BP #772). Attach the sway bar to the sway bar end links with the original hardware. Torque the 7/16" hardware to 45 ft-lbs. Torque sway bar link nut to 45 ft-lbs.
73. Install the supplied driveshaft spacer and reattach front driveshaft to differential with new hardware (BP# 925). Torque bolts to 76 ft-lbs. (Fig 29)

FIGURE 29



74. Install the wheels and lower the vehicle to the ground.
75. Bounce the front of the vehicle to settle the suspension. 2009-13 models: Torque the lower strut mount bolt to 350 ft-lbs. 2014 models: Torque the lower strut mount bolts to 80 ft-lbs. Center the lower control arm cams and torque to 150 ft-lbs. Tighten upper strut mounting hardware on replacement strut kits to 35 ft-lbs. Adjust the toe before driving it to an alignment shop.
76. Check all hardware for proper torque.

REAR INSTALLATION

77. Block the front wheels and raise the rear of the vehicle. Place jack stands under the frame rails ahead of the spring hangers.
78. Remove the wheels.
79. The parking brake cable must be relocated. To disconnect the cable from the frame first pull down on the cable and clamp it off with vise grips near the middle of the frame (Fig 30). This will gain slack to disconnect the driver's side rear cable from the main (passenger's side) cable.
80. Remove the driver's side parking brake cable from the junction bracket (Fig 31).

FIGURE 30



FIGURE 31



81. Compress the retaining tabs and remove the driver's side cable from the spring hanger (Fig 32). It will be relocated and reconnected later.
82. Disconnect the rear brake line from the frame. (Fig 33)

FIGURE 32

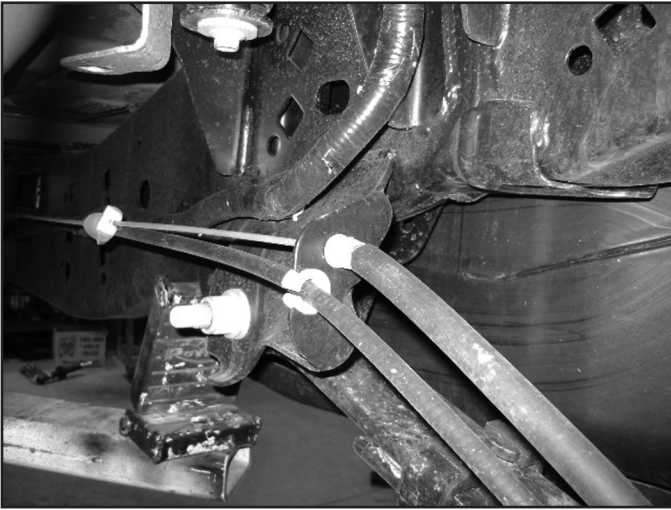
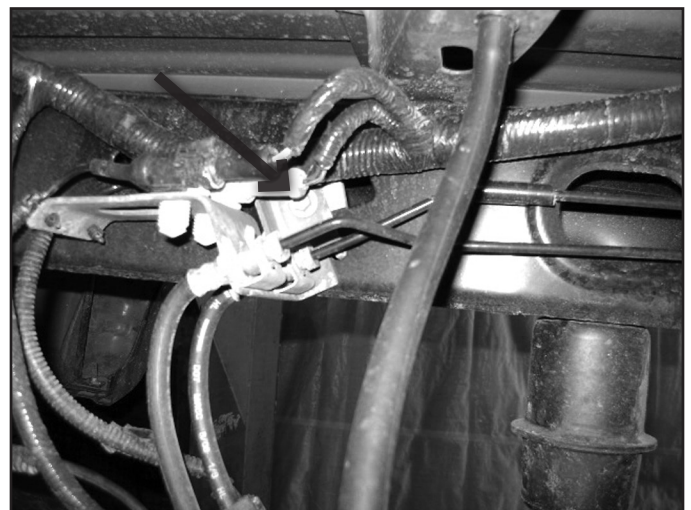


FIGURE 33



83. Support the rear axle with a hydraulic jack. Remove the OE shocks. Retain mounting hardware.
84. Note: Perform the rear installation on one side at a time.
85. Remove the passenger's side u-bolts.
86. Lower the axle and remove the OE lift block, it will not be reused.
87. 5" rear block kit, follow steps 89-93. 4" rear block kit follow steps 94-95.
88. Using C-clamps, clamp the leaf spring pack together on each side of the center pins. Remove the center pins and discard.
89. Place the plate on the bottom of the leaf pack and secure with new center pin in the 'forward' hole and flat head allen bolt through the 'rear' hole. Install new u-bolt retaining plate on top, it will be offset 'forward'. Tighten to 35 ft-lbs. (Fig 34, Fig 35A, B)

FIGURE 34

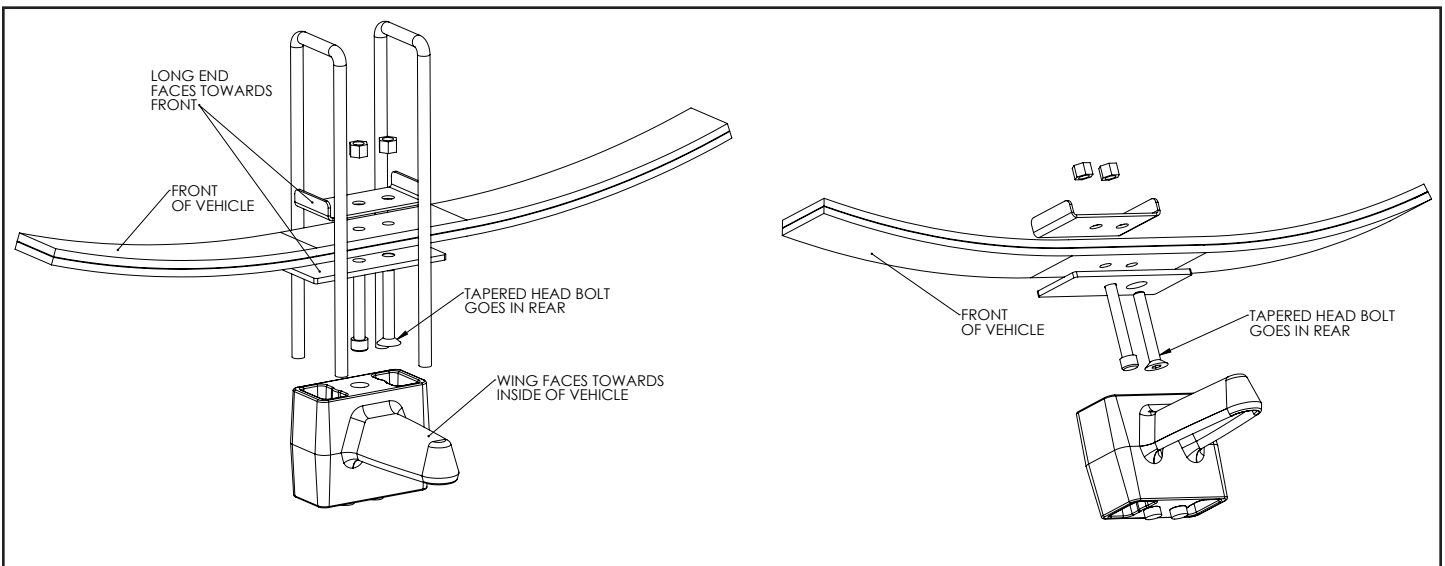
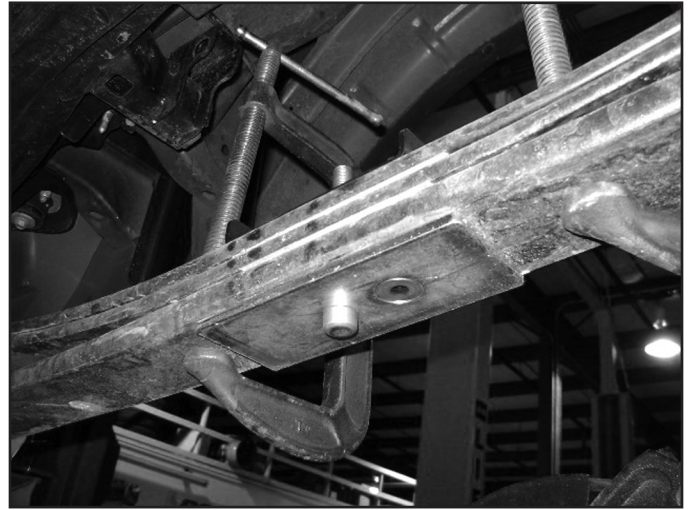


FIGURE 35A

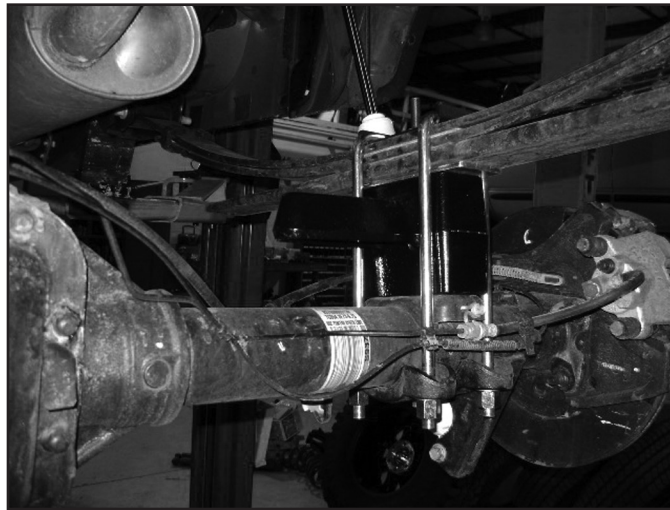


FIGURE 35B



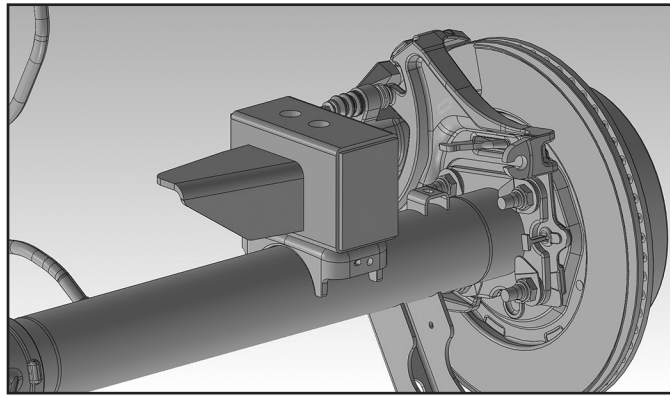
90. Install the new provided lift block so that the bump stop wing goes toward the inside of the vehicle. The block will use the both of the lower center pin holes. The upper only uses 1 hole which will shift the axle slightly forward.
91. Raise the axle/block to the spring while aligning the center pin. Fasten the spring/block assembly with the provided u-bolts, high nuts and washers. Snug u-bolts, they will be torque with the weight of the vehicle on the springs. (Fig 36a)

FIGURE 36A



92. Repeat installation procedure on the driver's side of the vehicle. Skip ahead to step #96
93. Install rear block (02429 - DRV side, 02430 - Pass side). The block is designed to offset the axle forward slightly. The bump stop wing will be centered under the bump stop on the frame with the vertical gusset facing towards the front of the vehicle. Align the center pins and raise axle. Fig 36b

FIGURE 36B



- 94. Attach u-bolts with the factory lower u-bolt plate. Snug u-bolts, they will be torqued to specification when the vehicle is on the ground.
- 95. Install the provided parking brake relocation bracket to the driver's side front spring hanger using 7/16" bolts, washers, and nuts. Late 2012 models and newer will require the retaining wire to be bolted to the bracket with 1/4" hardware (#768). (Fig 37a, 37b)

FIGURE 37A

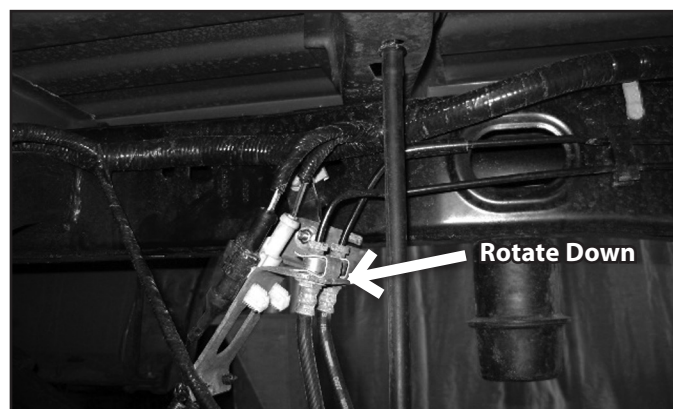


FIGURE 37B



- 96. Reconnect the parking brake cable at the junction. When reconnected, remove the clamp to allow the cable to return to its normal tension. Attach the parking brake cable through the relocation bracket through the slot in the bottom. Note: Models with automatic retracting running boards will require an additional bracket to have the cable clear the linkage. This optional accessory bracket kit #123018 is available separately.
- 97. Install the provided brake line relocation bracket to the driver's side frame rail with the OE brake line bracket bolt (Fig 38). Torque to 15 ft-lbs.

FIGURE 38



98. Attach the brake line to the relocation bracket with a ¼" nut and ¼" USS washer (BP #774). It may be necessary to rotate the OE brakeline clip bracket to have the lines face 'down' for adequate slack. Torque to 15 ft-lbs.
99. Install the provided new BDS shocks with the OE hardware. Torque to 60 ft-lbs.
100. Check all lines/wires for proper slack.
101. If the vehicle is equipped with EPAS, reconnect the power steering control module connector.
102. Install the wheels and lower the vehicle to the ground.
103. Bounce the rear of the vehicle to settle the suspension.
104. Torque the u-bolts to 100-120 ft-lbs.
105. Check all hardware for proper torque
106. Check hardware after 500 miles.
107. A complete front end alignment is necessary.
108. Adjust headlights.



WE WANT TO SEE YOUR RIDE!

Grab photos of your BDS-equipped truck in action and send them in for a chance to be featured. Send it in to our Bad Ass Rides customer gallery at bds-suspension.com/bar and post them on the BDS Fan Page on Facebook at facebook.com/BDSSuspensions. Don't forget about your BDS swag! BDS offers t-shirts, hoodies, decals and more available on the BDS website or through your local BDS distributor.

TIME TO HAVE SOME FUN

Thank you for choosing BDS Suspension.

For questions, technical support and warranty issues relating to this BDS Suspension product, please contact your distributor/installer before contacting BDS Suspension directly.