

# INSTALLATION GUIDE

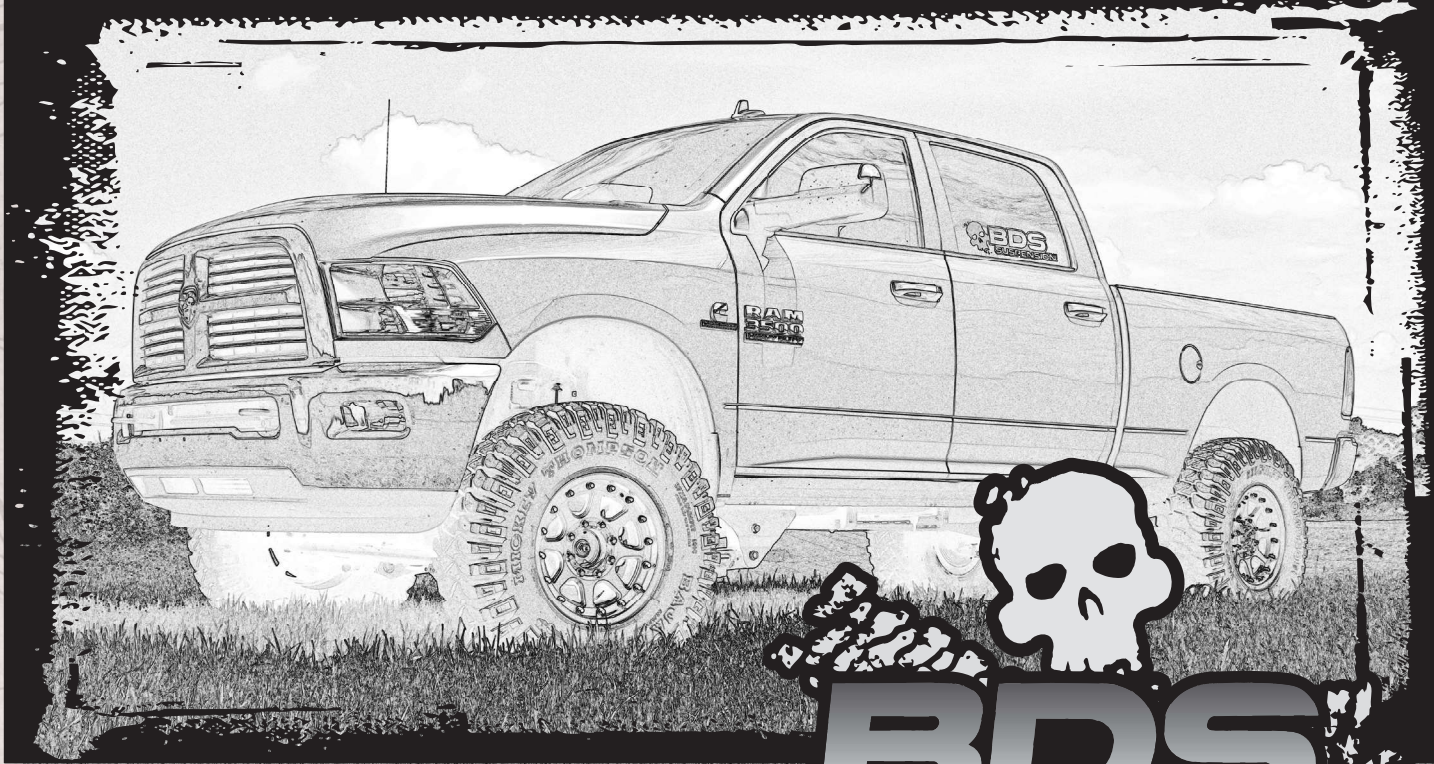

Part#: 012619



**HARDCORE LIMITED LIFETIME WARRANTY**

## 8" Rear Suspension System

**Dodge Ram 2500 | 2014**

Rev. 070518

491 W. Garfield Ave., Coldwater, MI 49036 • Phone: 517-279-2135

Web: [www.bds-suspension.com](http://www.bds-suspension.com) • E-mail: [tech-bds@ridefox.com](mailto:tech-bds@ridefox.com)



# Read And Understand All Instructions And Warnings Prior To Installation Of System And Operation Of Vehicle.

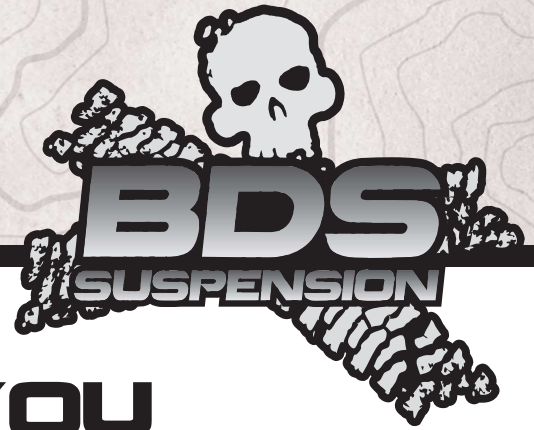

## THANK YOU

Your truck is about to be fitted with the best suspension system on the market today. That means you will be driving the baddest looking truck in the neighborhood, and you'll have the warranty to ensure that it stays that way for years to come.

Thank you for choosing BDS Suspension!

### BEFORE YOU START

BDS Suspension Co. recommends this system be installed by a professional technician. In addition to these instructions, professional knowledge of disassembly/ reassembly procedures and post installation checks must be known.

### FOR YOUR SAFETY

Certain BDS Suspension products are intended to improve off-road performance. Modifying your vehicle for off-road use may result in the vehicle handling differently than a factory equipped vehicle. Extreme care must be used to prevent loss of control or vehicle rollover. Failure to drive your modified vehicle safely may result in serious injury or death. BDS Suspension Co. does not recommend the combined use of suspension lifts, body lifts, or other lifting devices. You should never operate your modified vehicle under the influence of alcohol or drugs. Always drive your modified vehicle at reduced speeds to ensure your ability to control your vehicle under all driving conditions. Always wear your seat belt.

### BEFORE INSTALLATION

- Special literature required: OE Service Manual for model/year of vehicle. Refer to manual for proper disassembly/reassembly procedures of OE and related components.
- Adhere to recommendations when replacement fasteners, retainers and keepers are called out in the OE manual.
- Larger rim and tire combinations may increase leverage on suspension, steering, and related components. When selecting combinations larger than OE, consider the additional stress you could be inducing on the OE and related components.
- Post suspension system vehicles may experience drive line vibrations. Angles may require tuning, slider on shaft may require replacement, shafts may need to be lengthened or trued, and U-joints may need to be replaced.
- Secure and properly block vehicle prior to installation of BDS Suspension components. Always wear safety glasses when using power tools.
- If installation is to be performed without a hoist, BDS Suspension Co. recommends rear alterations first.
- Due to payload options and initial ride height variances, the amount of lift is a base figure. Final ride height dimensions may vary in accordance to original vehicle attitude. Always measure the attitude prior to beginning installation.



Visit [560plus.com](http://560plus.com) for more information.

### TIRES AND WHEELS

40x13.50x17/18/20 Tire  
4-1/2"-5" Backspace Wheel



### BEFORE YOU DRIVE

Check all fasteners for proper torque. Check to ensure for adequate clearance between all rotating, mobile, fixed, and heated members. Verify clearance between exhaust and brake lines, fuel lines, fuel tank, floor boards and wiring harness. Check steering gear for clearance. Test and inspect brake system.

Perform steering sweep to ensure front brake hoses have adequate slack and do not contact any rotating, mobile or heated members. Inspect rear brake hoses at full extension for adequate slack. Failure to perform hose check/ replacement may result in component failure. Longer replacement hoses, if needed can be purchased from a local parts supplier.

Perform head light check and adjustment.

Re-torque all fasteners after 500 miles. Always inspect fasteners and components during routine servicing.

# CONTENTS OF YOUR KIT

## 012619 Box Kit

Part #	Qty	Description
A253	1	Rear Upper Coil Mount - DRV
02870	1	Rear Upper Bracket - DRV
01572	1	BDS Name Plate - Stainless
97525A420	2	Rivets (1/8" Dia x 0.251-0.312)
A254	1	Rear Upper Coil Mount - Pass
02871	1	Rear Upper Bracket - Pass
01572	1	BDS Name Plate - Stainless
97525A420	2	Rivets (1/8" Dia x 0.251-0.312)
02872	1	Lower Rear Coil Mount - DRV
02873	1	Lower Rear Coil Mount - PASS
B1146	1	Bag Kit
02883	4	Rear Outboard Coil Mount - Outer Nut Tab
02884	1	Rear Coil Mount - DRV - Inner Nut Tab
02885	1	Rear Coil Mount - PASS - Inner Nut Tab
M20500-BK	2	Bump Stop
01457	2	Wide Spacer - Rear
75	2	Narrow Spacer - Front
N38FLG	2	3/8"-16 Flange Lock Nut Clear Zinc
NP54801	1	1/2"-13 taper hand tap
B1147	1	Bag Kit
02874	1	Dodge Ram 2500 Rear Trackbar Bracket
02879	1	Dodge Ram 2500 Rear Trackbar Support Tube
911123	2	Sway Bar Link 19" (EB2-EB2)
A252	1	Rear Track Bar Assembly
02818	1	Rear Track Bar
A175	1	Forged COM Assembly
B1145	1	Bag Kit
02819	2	COM Adapter
3535BK	2	Bushing
146	1	Sleeve
516	1	Grease Fitting
M02016BK	4	EB2 Bushing
93	4	0.750 x 12mm ID x 1.575 DOM
02880	1	Dodge Ram 2500 Rear Brakeline Bracket
687	1	Bolt Pack - Sway Bar Links
	4	12mm-1.75 x 70mm Bolt
	4	12mm-1.75 Prevailing Torque Nut
	8	7/16" USS Washer

## 685 Bolt Pack

Part #	Qty	Description
	8	1/2"-13 x 1-1/2" Bolt - Grade 8 - Yellow Zinc
	12	1/2" SAE Thru Hardened Washer - Yellow Zinc
	4	M10-1.5 x 30mm Flat-Head Socket Cap Screw
	4	1/2"-13 x 1-3/4" Bolt - Grade 8 - Yellow Zinc
	2	7/16"-14 x 1-1/2" Bolt Grade 8 - Yellow Zinc
	4	7/16" SAE Thru - Hardened Washer - Yellow Zinc
	2	7/16"-14 Prevailing Torque Nut - Yellow Zinc

## 686 Bolt Pack

Part #	Qty	Description
	2	9/16"-12 x 4" Bolt - Grade 8 - Yellow Zinc
	4	9/16" SAE Thru-Hardened Washer - Yellow Zinc
	2	9/16"-12 Prevailing Torque Nut - Yellow Zinc
	1	3/8"-16 x 1-1/2" Bolt - Grade 8 - Yellow Zinc
	1	3/8" SAE Thru-Hardened Washer - Yellow Zinc
	1	3/8"-16 Serrated Edge Flanged Nut - Clear Zinc
	1	1/2"-13 x 3" Bolt - Grade 8 - Yellow Zinc
	1	1/2" SAE Thru-Hardened Washer - Yellow Zinc
	1	1/2"-13 Serrated Edge Flanged Nut - Clear Zinc
	4	1/4"-20 x 3/4" Bolt - Grade 5 - Clear Zinc
	4	1/4" USS Washer- Clear Zinc
	4	1/4"-20 Serrated Edge Flanged Nut - Clear Zinc

## 687 Bolt Pack - Sway Bar Links

Part #	Qty	Description
	4	12mm-1.75 x 70mm Bolt - Class 10.9 - Clear Zinc
	4	12mm-1.75 Prevailing Torque Nut - Clear Zinc
	8	7/16" USS Washer - Clear Zinc

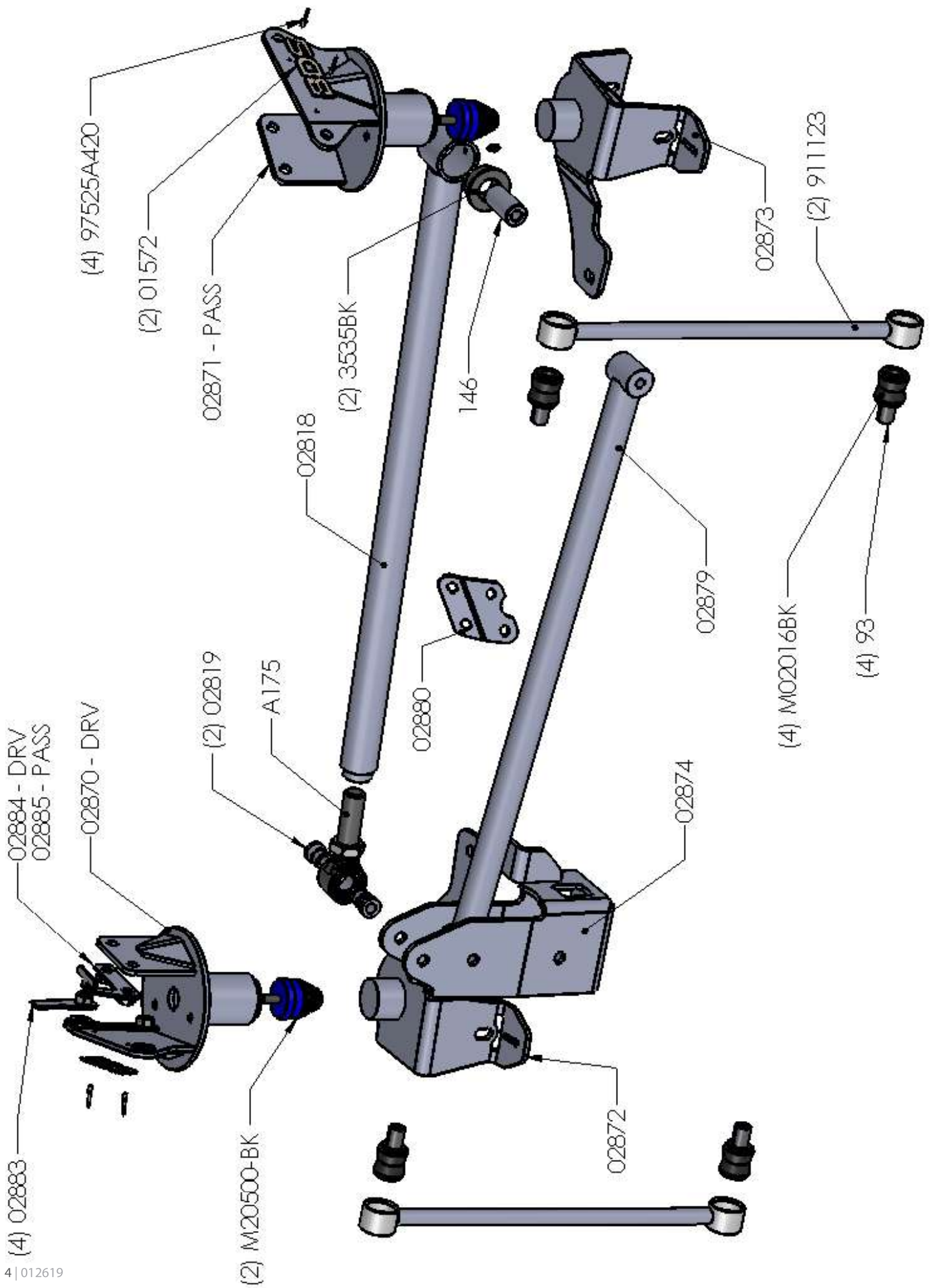

## TECH TIPS

### TROUBLESHOOTING INFORMATION FOR YOUR VEHICLE

1. If rear driveline vibration is present, order BDS # 122007 to increase driveshaft spline engagement. at the transfer case output.
2. Upgraded transmission output shaft recommended for vehicles with aftermarket programmers. There will be increased stress on the drive train with the heavier than stock wheel and tire combination and also 1/4" less engagement on the transmission output shaft. Drive accordingly.

## INSTALLATION INSTRUCTIONS

### INSTALLATION INSTRUCTIONS

1. Park vehicle on clean, flat, and level surface. Block the front wheels for safety.
2. Remove the rear track bar from the vehicle. Retain all hardware.
3. Raise the rear of the vehicle and support the frame rails with jack stands.
4. Remove the rear wheels.
5. Support the rear axle with a hydraulic jack.
6. Disconnect the rear brake line bracket from the differential. (Fig 1)

### SPECIAL TOOLS

Drill Bits and Drill  
Jackstands and Hydraulic Jack.

**FIG 1**



7. Remove the e-brake cable retaining bracket above the rear upper control arm at the frame. It will not be reinstalled. (Fig 2)



**FIG 2**

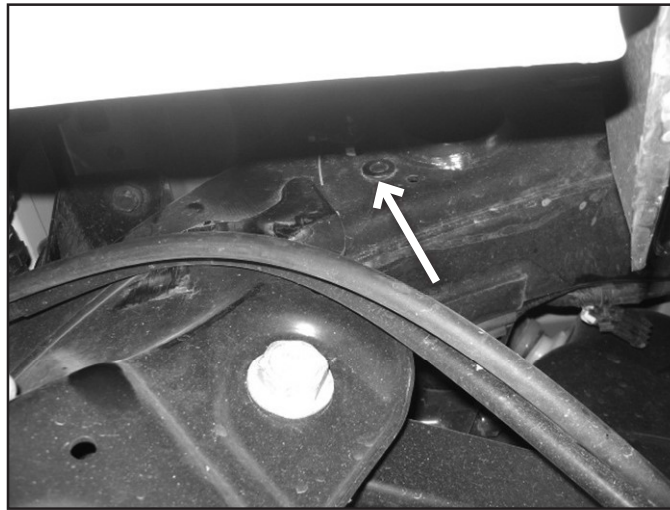

8. Remove the factory sway bar links, retain hardware.
9. Disconnect rear shocks, retain lower hardware. To access the top shock hardware, either remove the inner fender liner or trim the inner fender as shown. (Fig 3)

**FIG 3**



10. Lower the axle and remove the factory coil springs; retain both coil spring isolators.
11. Remove the factory bump stop brackets from the frame rail, bump stops and hardware will not be reused. (Fig 4)

**FIG 4**



## LOWER BRACKET INSTALLATION:

12. Remove the rear brake line bracket hardware from the backside of the axle, discard hardware. (Fig 5)

**FIG 5**



13. Drill the factory holes out to 27/64"; if drill bit is unavailable, use a 7/16".
14. Hand tap the holes to 1/2"-13 with the included tap. Tapping trick: Use a 12 point 5/16" (8mm) socket that fits on the head of the tap with a ratchet to cut threads. Use lubricant on tap to aid in cutting threads. (Fig 6) Do NOT use an impact!

**FIG 6**



15. Enlarge the holes on the factory lower coil buckets to 1/2" - 9/16", where the new lower coil seat brackets will be placed. (Fig 7)

**FIG 7**

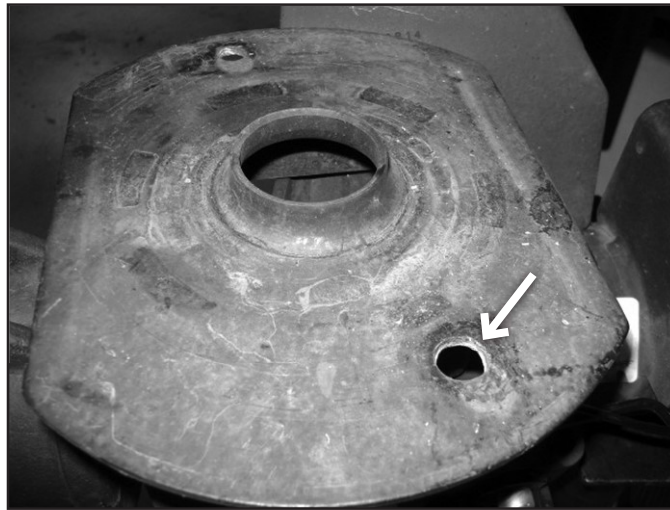

16. Place the lower coil seat brackets on the axle. Use the wide spacer at the rear (#01457) and the thinner spacer (#75) at the front side of the axle to space out the bracket. Attach brake lines to the new bracket with included 1/4" hardware (BP# 686) (Fig 8a, 8b)

**FIG 8A (WIDE SPACER)**

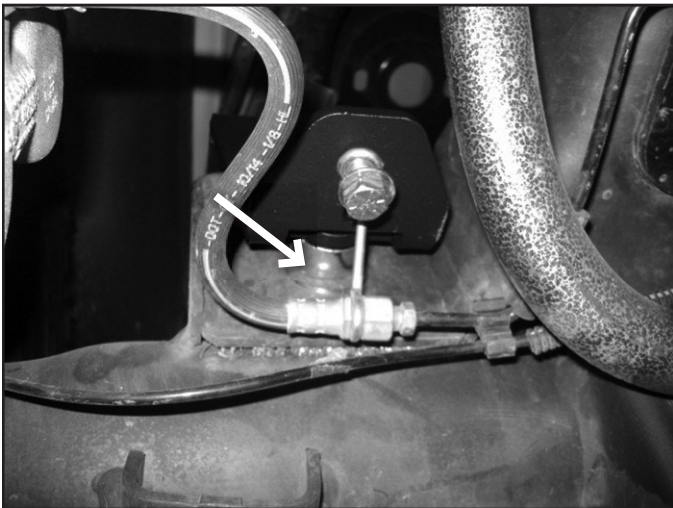
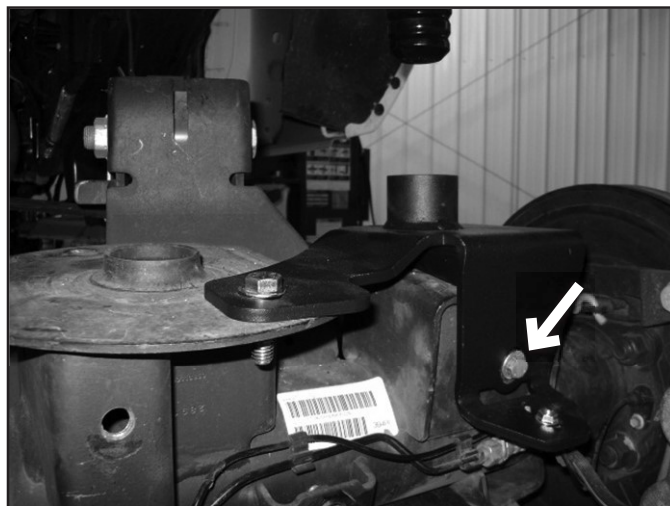

**FIG 8B (NARROW SPACER)**



17. Attach brackets to the original lower bump stop pad with 1/2" hardware, leave loose at this time. Do not attach the Driver's side where the trackbar support bracket will attach at the factory coil bucket. (Fig 9)

**FIG 9**





18. Place the new trackbar bracket onto the OEM mount. Align holes and attach with hardware as shown. Brake line on the driver's side may need to be formed slightly to clear the bracket. (Fig 10a, 10b)

**FIG 10A**



**FIG 10B**

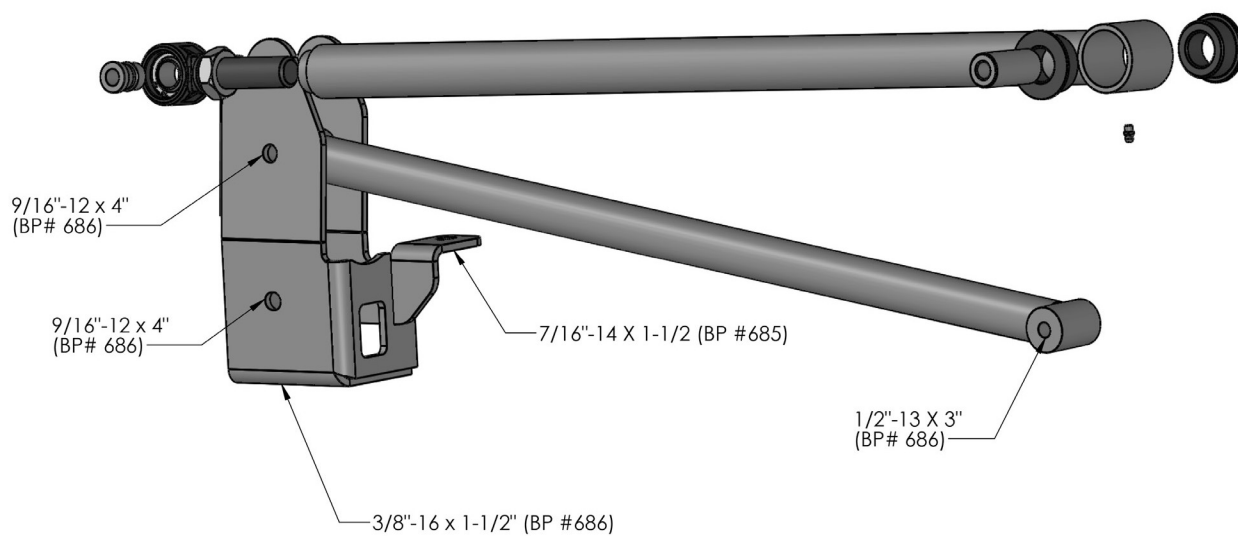

19. Install the trackbar support brace into the trackbar bracket with 9/16" hardware; do not tighten at this time. Swing the brace up to the passenger's side of the axle. Mark center of mounting tube and drill out to 1/2". Attach with 1/2" hardware and serrated edge flanged nut inside the factory bracket. Check for sway bar range of motion before drilling hole. Adjust support bar up higher if necessary. (Fig 11)

**FIG 11**



20. Install 7/16" hardware through the coil relocation mount and trackbar bracket. Tighten the 7/16" & 1/2" lower coil bracket hardware to 55 ft-lbs. Tighten the 3/8" bolt to 35 ft-lbs, 9/16" bolt in the original factory hole to 95 ft-lbs. Do not tighten the support tube hardware at this time, it will make installing the trackbar difficult.

### **UPPER BRACKET INSTALLATION:**

21. Install the new urethane bump stop to each of the upper coil spring mounts (02870 – Driver, 02871 – Passenger) through the clearance hole on the top side using the provided 3/8" serrated edge nut. It is easiest to use a 6" extension with a 9/16" short well socket to attach the bump stop to the mount. Tighten nut securely.

**FIGURE 12**

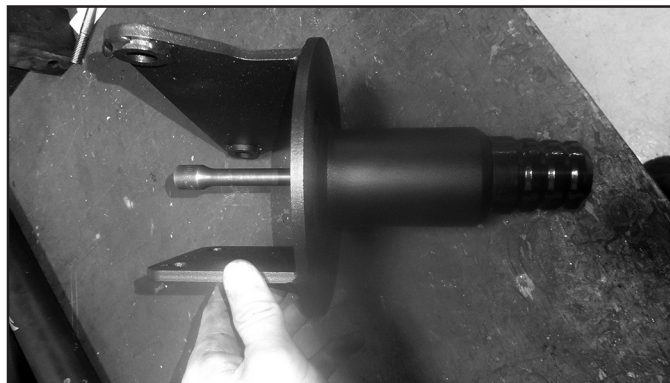

22. Install the upper coil spring mounts (02870 – Driver, 02871 – Passenger) with new 10mm flat-head socket cap screws (BP 685) to the bump stop mounts on the frame (Figure 13A). Be sure to start both of the 10mm flat head socket cap screw before tightening them down. Mark the 4 holes to be drilled to attach the upper coil spring mount to the frame, and then remove the upper coil spring mount (Figure 13B). Drill all 4 holes to 9/16" for both the passenger and driver sides (Figure 13C)

**FIGURE 13A**



**FIGURE 13B**



**FIGURE 13C**



23. Apply Loctite to the 10mm flat-head socket cap screw and re-install the upper coil spring mounts to the bump stop mounts on the frame. Tighten to 35 ft-lbs.



24. Starting on the outside of the frame, insert a nut tab through the slot above the coil spring mount (Figure 14A). Line up the nut on the nut tab with the previous drilled hole (Figure 14B) and attach using a 1/2" x 1-1/2" bolt and washer (BP 685). Repeat for both outside holes on the upper coil spring mount (Figure 14C). On the inside of the frame, insert a nut tab through the slot above the coil spring mount (Figure 14D). The inside nut tabs are side specific (Figure 14E). Line up the nuts on the nut tab with the two previously drilled holes and attach using two 1/2" x 1-1/2" bolt and washer. Tighten all 1/2" hardware to 65 ft-lbs.

**FIGURE 14A**

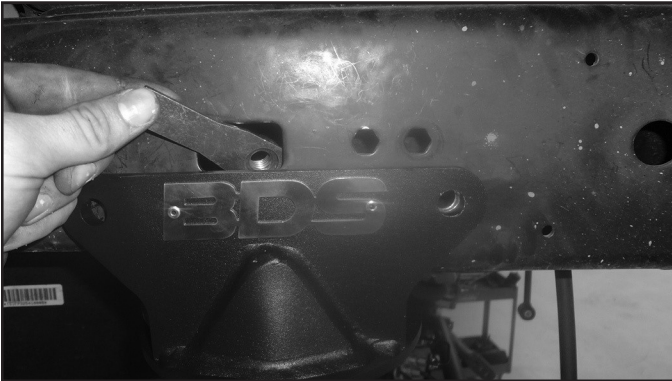

**FIGURE 14B**

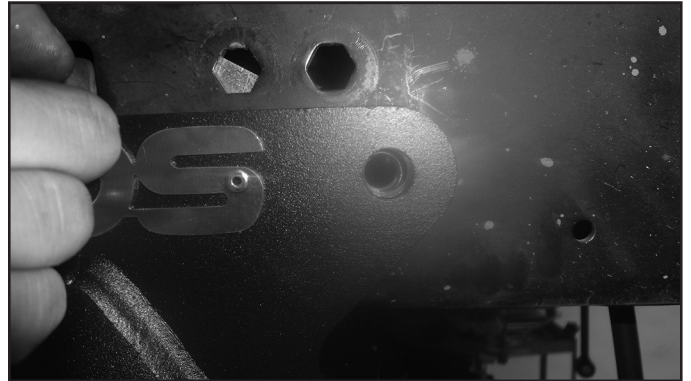

**FIGURE 14C**



**FIGURE 14D**

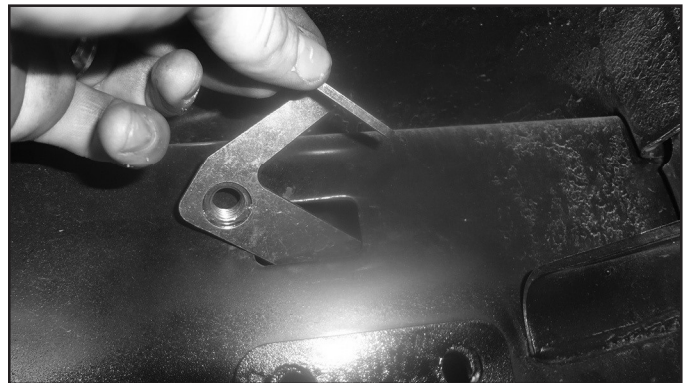

**FIGURE 14E**

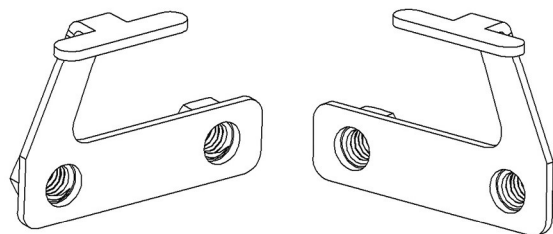

Driver Side

Passenger Side

## COIL AND SHOCK INSTALLATION:

25. Install the new coil adaptor into one end of the coil. Attach the small OEM rubber coil isolator onto the other end of the coil. Install the coil with the new isolator at the upper mount and factory mount at the lower position. (Fig 15a, 15b)

**FIG 15A**



**FIG 15B**



26. Grease and install bushings and sleeves into the shocks. Attach the clevis brackets to the shocks with included hardware. Install the shocks into the vehicle. The locating tab on the clevis bracket will go into the factory hole, ensure it is installed correctly, the bracket will offset the shock rear-ward. (Fig 16)

**FIG 16**



27. Attach shocks to the axle with factory hardware. Tighten to 65 ft-lbs.
28. Sway Bar Link Installation:
29. Grease and install bushings and sleeves into the sway bar links. Install sway bar links with 12mm hardware (#687). (Fig 17)

**FIG 17**



30. Attach the brake line relocation bracket to the top side of the axle with factory hardware and new 1/4" hardware (#686). (Fig 18)

**FIG 18**



## **TRACK BAR INSTALLATION:**

31. Grease and install bushings and sleeve into adjustable trackbar. Install grease zerk into eyelet. Install COM bearing adaptors into the adjustable end.
32. Adjust trackbar to the same length as the stock trackbar.
33. Install the COM bearing end of the track bar into the relocation bracket at the axle with the factory bolt and flagged nut. Tighten all trackbar hardware including the support tube hardware at this time. Tighten 9/16" & factory 14mm hardware to 95 ft-lbs, 1/2" hardware to 65 ft-lbss. Use a wrench to hold the factory flagged nut to keep from spinning. (Fig 19)



**FIG 19**

## 2014 DODGE RAM 2500 REAR TRACKBAR ASSEMBLY

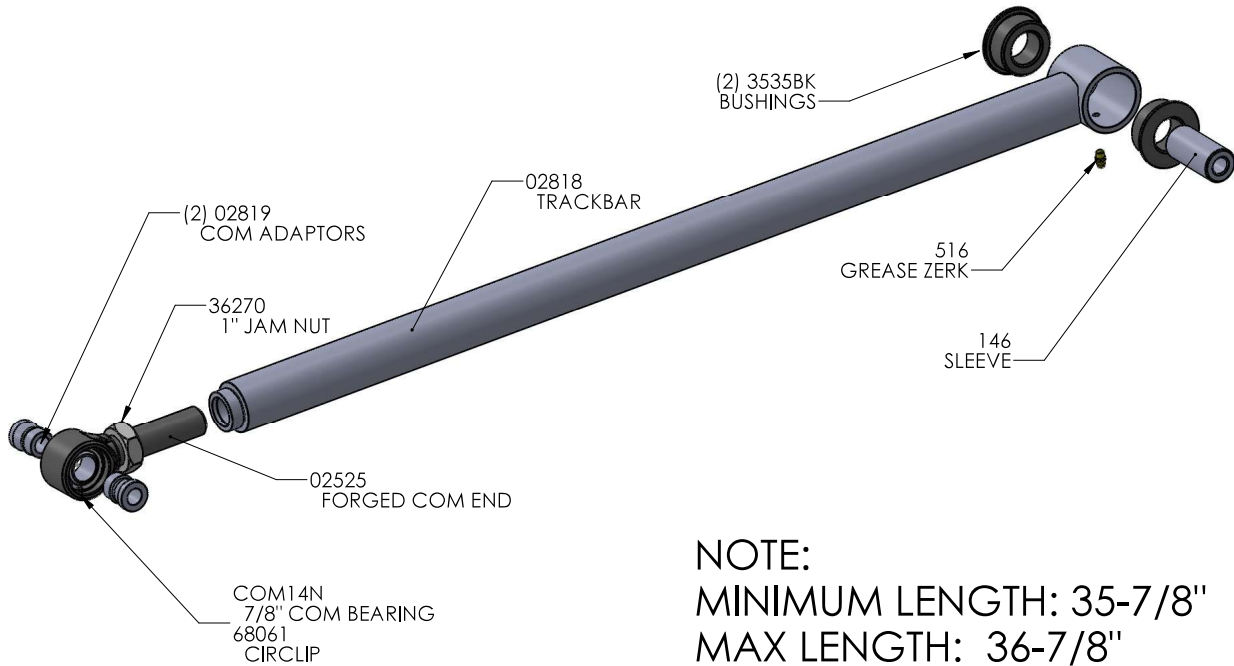

34. Lower vehicle to the ground. Grease the bushing faces and install trackbar into the frame mount on the passenger's side with urethane bushings with factory hardware. Tighten frame mount to 95 ft-lbs. Grease the trackbar at this time.
35. Recheck all hardware for proper torque. Check again after 500 miles.
36. A front end alignment is required with the addition of a front end lift. Do not drive the vehicle with the steering wheel off-center or traction control problems may arise.



### **WE WANT TO SEE YOUR RIDE!**

Grab photos of your BDS-equipped truck in action and send them in for a chance to be featured. Send it in to our Bad Ass Rides customer gallery at [bds-suspension.com/bar](http://bds-suspension.com/bar) and post them on the BDS Fan Page on Facebook at [facebook.com/BDSSuspensions](https://facebook.com/BDSSuspensions). Don't forget about your BDS swag! BDS offers t-shirts, hoodies, decals and more available on the BDS website or through your local BDS distributor.

## **TIME TO HAVE SOME FUN**

**Thank you for choosing BDS Suspension.**

For questions, technical support and warranty issues relating to this BDS Suspension product, please contact your distributor/installer before contacting BDS Suspension directly.