

INSTALLATION GUIDE

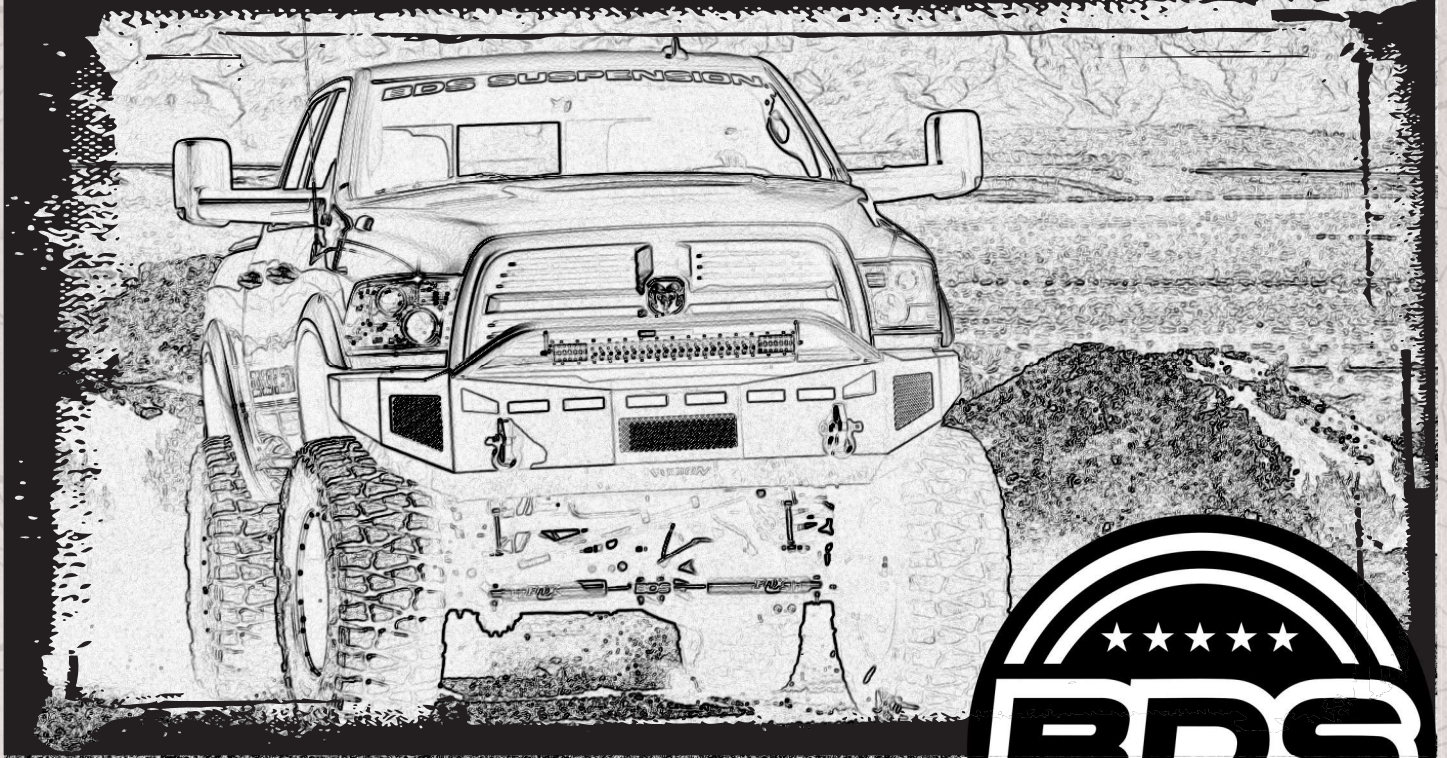

Part#: 012810



HARDCORE LIMITED LIFETIME WARRANTY

8" 4-Link Suspension System

2014-2018 Ram 2500 Diesel 4WD

2013-2018 Ram 3500 Diesel 4WD

Rev. 020524

491 W. Garfield Ave., Coldwater, MI 49036 • Phone: 517-279-2135

E-mail: tech-bds@ridefox.com

Read And Understand All Instructions And Warnings Prior To Installation Of System And Operation Of Vehicle.

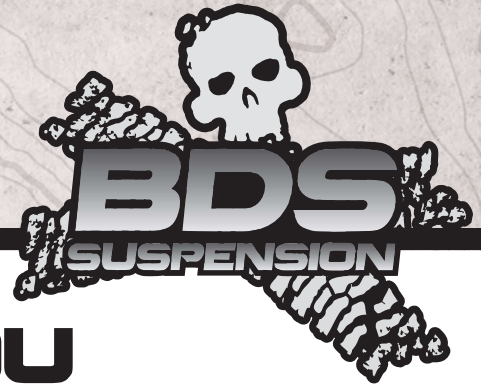

THANK YOU

Your truck is about to be fitted with the best suspension system on the market today. That means you will be driving the baddest looking truck in the neighborhood, and you'll have the warranty to ensure that it stays that way for years to come. Thank you for choosing BDS Suspension!

BEFORE YOU START

BDS Suspension Co. recommends this system be installed by a professional technician. In addition to these instructions, professional knowledge of disassembly/ reassembly procedures and post installation checks must be known.

FOR YOUR SAFETY

Certain BDS Suspension products are intended to improve off-road performance. Modifying your vehicle for off-road use may result in the vehicle handling differently than a factory equipped vehicle. Extreme care must be used to prevent loss of control or vehicle rollover. Failure to drive your modified vehicle safely may result in serious injury or death. BDS Suspension Co. does not recommend the combined use of suspension lifts, body lifts, or other lifting devices. You should never operate your modified vehicle under the influence of alcohol or drugs. Always drive your modified vehicle at reduced speeds to ensure your ability to control your vehicle under all driving conditions. Always wear your seat belt.

BEFORE INSTALLATION

Special literature required: OE Service Manual for model/year of vehicle. Refer to manual for proper disassembly/reassembly procedures of OE and related components.

Adhere to recommendations when replacement fasteners, retainers and keepers are called out in the OE manual.

Larger rim and tire combinations may increase leverage on suspension, steering, and related components. When selecting combinations larger than OE, consider the additional stress you could be inducing on the OE and related components.

Post suspension system vehicles may experience drive line vibrations. Angles may require tuning, slider on shaft may require replacement, shafts may need to be lengthened or trued, and U-joints may need to be replaced.

Secure and properly block vehicle prior to installation of BDS Suspension components. Always wear safety glasses when using power tools.

If installation is to be performed without a hoist, BDS Suspension Co. recommends rear alterations first.

Due to payload options and initial ride height variances, the amount of lift is a base figure. Final ride height dimensions may vary in



Visit 560plus.com for more information.

TIRES AND WHEELS

8" Lift:

40x13.50 w/ 4.5" to 5.5" Backspacing on 9" wide wheel. Minor modification to inner plastic fender well may be required. Certain running boards may require modification to clear this size tire.

This is the largest size that fits, wider & taller tires / rims will increase the amount of trimming required.



accordance to original vehicle attitude. Always measure the attitude prior to beginning installation.

BEFORE YOU DRIVE

Check all fasteners for proper torque. Check to ensure for adequate clearance between all rotating, mobile, fixed, and heated members. Verify clearance between exhaust and brake lines, fuel lines, fuel tank, floor boards and wiring harness. Check steering gear for clearance. Test and inspect brake system.

Perform steering sweep to ensure front brake hoses have adequate slack and do not contact any rotating, mobile or heated members. Inspect rear brake hoses at full extension for adequate slack. Failure to perform hose check/ replacement may result in component failure. Longer replacement hoses, if needed can be purchased from a local parts supplier.

Perform head light check and adjustment.

Re-torque all fasteners after 500 miles. Always inspect fasteners and components during routine servicing.

CONTENTS OF YOUR KIT

012403 - 4 Link Arms		
Part #	Qty	Description
02472	2	Dodge 4 link conversion - lower control arm
516	2	Straight Grease Zerk
7	2	Sleeve
3527BK	4	Bushing (Large - Lower Control Arm)
02473	2	Dodge 4 link conversion - Upper Control Arm
3537BK	2	Bushing (Small - Upper Control Arm)
60107	2	90 Deg Grease Zerk
61	2	Sleeve

012810		
Part #	Qty	Description
02594	1	4-Link Bracket - Drv
02595	1	4-Link Bracket - Pass
02449	2	BDS Badge
360	2	Rivet Bolt Packs
02596	2	1/16" Shim
02597	2	1/8in Shim
02470	2	Dodge weld in bung
02471	2	Dodge long machined spacer sleeve
7	2	Spacer Sleeve
73	2	1.250 x 0.312 x 0.875
799	1	Rivet nut installation bolt pack
95105A169	2	1/2" Rivet nuts
082405R	1	Pitman Arm
02988	1	8" BDS trackbar bracket
02474	2	Trackbar Cam 2013 Dodge 3500 (4 positions)
01499	1	1.00 x 0.2345 x 0.25 Spacer
01797	2	1/2" Bolt Tab
27031	1	Fish Wire
A239	2	Sway Bar Links
03012	2	Clevis Bracket
03029	2	Sleeve - Upper
149	2	Sleeve - Lower
M03212-BK-01	2	Offset Spacer
02475	2	Brake Line Brkt
B561G2	2	5/16" Self Taper
02255	2	Bump Stop Extensions
M02096bk	2	Poly Bump Stop
22517	2	Front Brake Line
CCW-03-050	4	Crush washer
5188	2	Clip
099000	8	Zip tie
0708760	4	Wire clip
785	1	Bolt Pack - Bump Stop Hardware

012810		
	4	3/8"-16 x 1-1/4 type 23 - self tapping screws - hex head - clear zinc
	4	3/8"-16 x 2" bolt - clear zinc
	6	3/8" SAE Washer - Clear zinc
	2	3/8" Split lock washer - clear zinc
	2	3/8"-16 nut - clear zinc
831	1	Bolt Pack
	1	1/2"-13 x 1-3/4" bolt - yellow zinc
	1	1/2"-13 Prevailing torque nut - yellow zinc
	2	1/2"-13 Nut (non locking) - yellow zinc
	4	1/2"-13 USS Washer - yellow zinc
	1	18mm-2.50 x 90mm bolt - clear zinc
	1	18mm-2.50 Prevailing torque nut - clear zinc
	2	3/4" SAE Washers - Clear zinc
788	1	Bolt Pack - 4 Link Brackets
	2	5/8"-11 x 6" bolt - yellow zinc
	4	5/8" USS Washer - yellow zinc
	2	5/8"-11 Prevailing torque nut - yellow zinc
	2	9/16"-12 x 4" bolt - yellow zinc
	4	9/16" SAE Washer - yellow zinc
	2	9/16"-12 Prevailing torque nut - yellow zinc
	2	3/4"-10 x 5-1/2" bolt - yellow zinc
	2	3/4"-10 x 5" bolt - yellow zinc
	8	3/4" SAE washer - yellow zinc
	4	3/4"-10 Prevailing torque nut - yellow zinc
	4	1/2"-13 x 1-1/4" bolt - yellow zinc
	4	1/2" USS Washer - yellow zinc
	2	5/16"-18 x 3/4" Self Threading Bolt
677	1	Bolt Pack - Front Sway Bar Links
	2	10mm-1.5 x 35mm button head bolt clear zinc
	2	10mm-1.5 nylock nut clear zinc
	2	10mm-1.5 x 50mm button head bolt clear zinc
	2	10mm external tooth lock washer clear zinc
	2	10mm flat washer clear zinc
	2	14mm-2.0 x 80mm bolt class clear zinc
	2	14mm-2.0 prevailing torque nut clear zinc
	4	9/16" SAE flat washer clear zinc

032802		
Part #	Qty	Description
032802R	2	8" Coils

PRE INSTALLATION

IMPORTANT

It is required that ride height measurements be taken before and after installation. Measure from the **WHEEL AXLE CENTER** up to the **FENDER LIP** of the wheel opening. Do this for all 4 wheels. Record measurements below.**

BEFORE

Left Front _____ *Right Front* _____

Left Rear _____ *Right Rear* _____

AFTER

Left Front _____ *Right Front* _____

Left Rear _____ *Right Rear* _____



***These ride heights will be required if you have any ride height concerns after installation. Please be prepared to provide these to Technical Support.*



INSTALLATION INSTRUCTIONS

PRE INSTALLATION NOTES:

-This kit is for diesel model trucks only. Gas model trucks will require extensive exhaust modifications and will achieve too much lift.

-Do NOT stack spacers on top of coils to get more lift!

-To maintain max payload capacity supplemental airbags are recommended and are not included.

-2500 Trucks, reference separate instruction sheet for rear installation (Rear box kit #012619)

SPECIAL TOOLS

- #1: Pitman arm puller
- #2: 11/16" drill bit (step drill highly recommended)
- #3: Welder
- #4: 9/16" drill bit (step drill bit can be used)

MEASURE FIRST

Measure and record from the center of the wheel up to the bottom edge of the wheel opening as shown on page 4.

4-LINK INSTALLATION INSTRUCTIONS

1. Park vehicle on clean flat and level surface. Block the rear wheels for safety.
2. Disconnect the battery / batteries, welding will be required. Do not weld on the vehicle with the batteries connected.
3. Remove the front trackbar bolt from the frame rail. Retain all hardware. (Fig. 1)

FIGURE 1



4. Raise the front of the vehicle and support the frame rails with jackstands. Do not support on the radius arms, they will be removed during the installation.

TRANSFER CASE INDEXING RING / CROSS MEMBER INSTALLATION



Tip *When the front driveshaft is disconnected: Before reattaching the front driveshaft, now is a great time to grease the nearly impossible to access grease fitting on the front dual cardan joint. A needle adaptor on a grease gun is required. This fitting is required to be serviced at every oil change interval. Ensure that this maintenance is not skipped!*

5. All 8" kits will require the installation of a transmission indexing ring and replacement crossmember. Reference the 6 bolt or 8 bolt (122813) instruction sheet at this time.

SUSPENSION DISASSEMBLY

6. Support the front axle with a hydraulic jack.
7. Remove the factory wheels, remove the retaining clips that hold the rotor on and may interfere with aftermarket wheels.
8. Remove the transmission skid plate (if equipped), retain hardware.
9. Break the jam nuts loose on the adjusting collar of the drag link. (Fig. 2)

FIGURE 2



10. Disconnect the tie rod from the pitman arm, do not damage the tie rod boot. Mark the orientation of the pitman arm and remove the pitman arm from the sector shaft. (Fig. 3)

FIGURE 3



11. Disconnect the sway bar links from the sway bar they will not be reinstalled. (Fig. 4)

FIGURE 4



12. Disconnect the brake line bracket from the top of the radius arm mount on the axle, retain bolt, discard bracket. (Fig. 5a)

FIGURE 5A

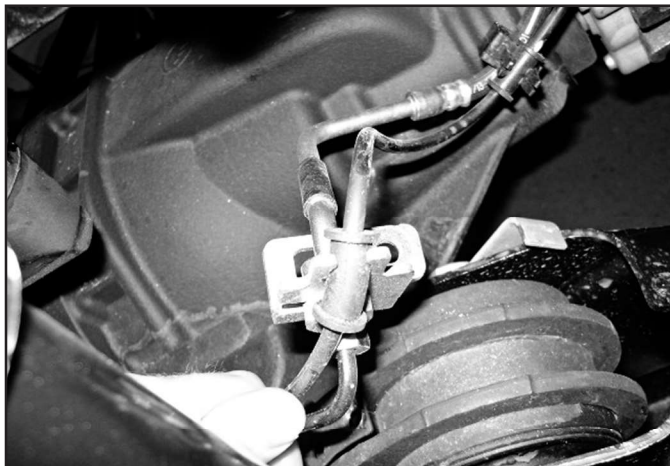

13. Disconnect the brake line from the ABS wires.

! Caution Do not allow large amounts of fluid to escape during installation, adverse affects to the ABS system may occur that requires a trip to the dealership.

14. Disconnect the stock brake line and replace with new brake line with NEW crush washers at the caliper with the factory banjo bolt. Tighten securely. Attach fitting to the frame with factory bracket. Figure 5b, 5c, 5d

FIGURE 5B

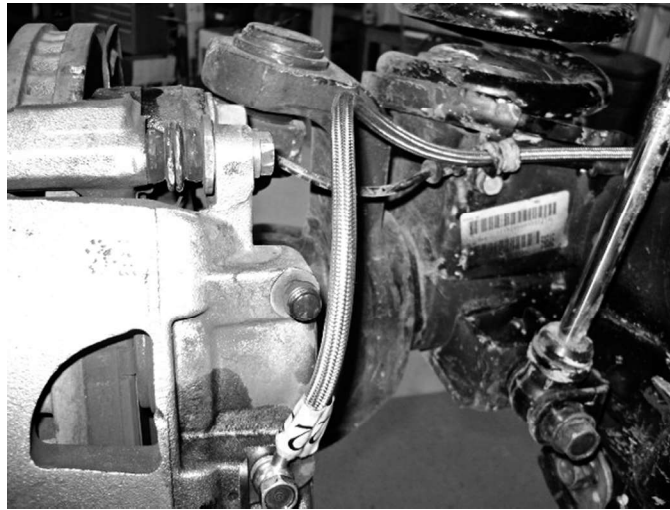

FIGURE 5C

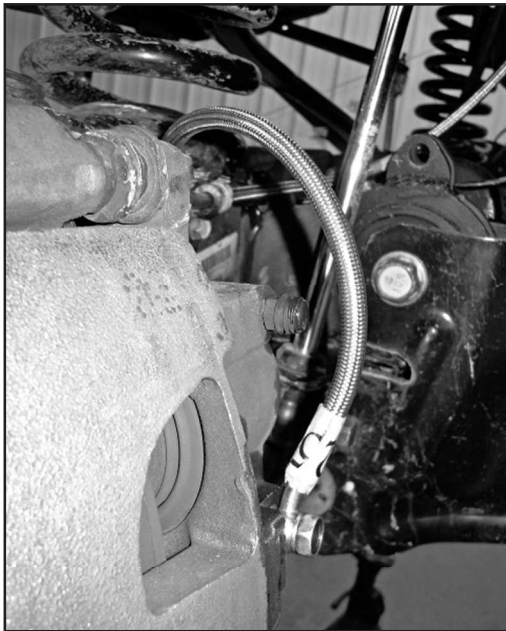
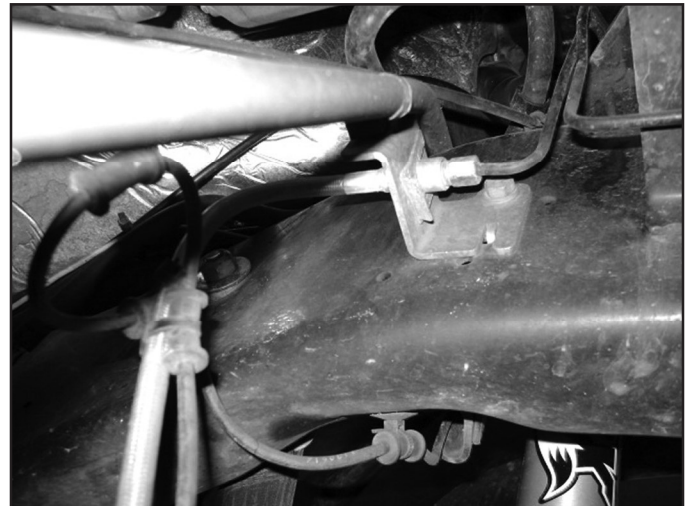

FIGURE 5D



15. Disconnect the front driveshaft from the axle, retain the 4 bolts.



Tip

The front driveshaft at the transfer case is extremely difficult to access once the kit is installed. Disconnecting it from the axle will let the driveshaft swing out of the way for access to 4-link hardware.

16. Disconnect the factory shock from the lower shock mount. (Fig. 6) Lower the front axle and remove the factory coil springs.

FIGURE 6



17. Raise the front axle and reattach factory shocks with factory bolt. It is not necessary to put the nut tab back on. The shocks will be there to keep the axle secure. Keep a jack under the axle for extra support.

4-LINK BRACKET INSTALLATION

18. Mark the cam at the axle. Remove the passenger's side radius arm. Retain all hardware. It will be necessary to remove the shock bolt and move the shock out of the way to get the upper hardware out. Reinsert the lower shock bolt when the arm is removed. This is a safety measure to keep the axle from moving an excessive amount.
19. On the passenger's side only. Measure and mark as shown (Fig. 7a,b). This material will need to be removed for clearance to the 4-link drop bracket. On the rear, the inside edge of the cut will be flush with the transmission crossmember and the outside edge will be flush with the radius arm mounting plate. Measure up $3/8$ " and remove this material for clearance. Similar to the rear, trim up the front side of the crossmember as shown by measuring up a quarter inch.

FIGURE 7A REAR SIDE

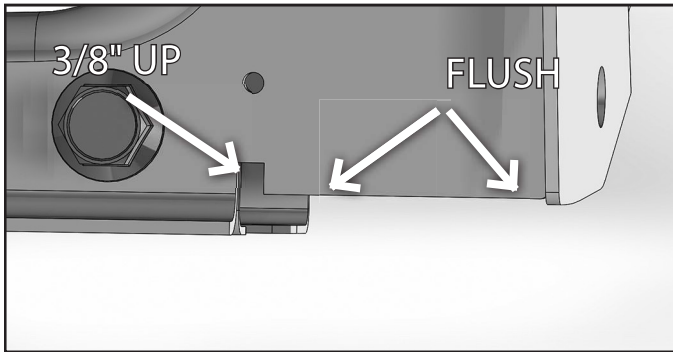
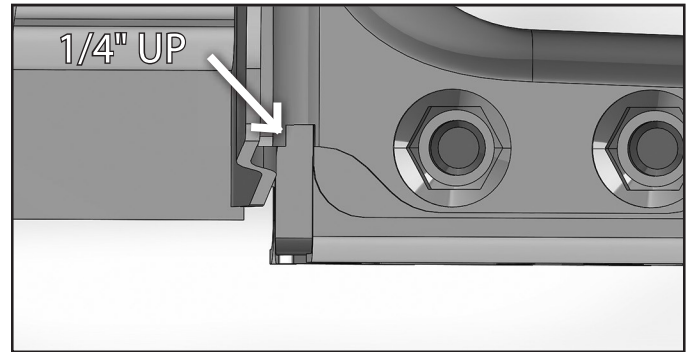
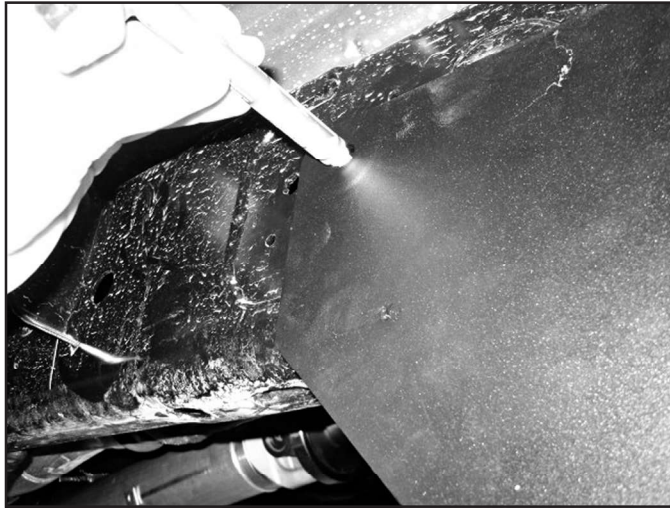

FIGURE 7B FRONT SIDE



20. Remove the nuts from the transmission crossmember, if not already done in the transfer case index installation. Place the 4-link bracket up to the frame rail. Insert $3/4$ " bolt to locate the bracket. Mark the center of the slot on the bottom of the frame rail, mark the center of the top, rear hole on the side of the frame rail. (Fig. 8)

FIGURE 8



21. Remove the bracket and drill the 2 centers to 11/16". Prep the area on the side of the frame rail for welding. Place the weld in bung into the hole and weld the bung into place. (Fig. 9)

FIGURE 9



22. Insert the rivet nut into the bottom of the frame rail. Use the hardware (#799) to set the rivet nut into place as shown (Fig. 10). See the end of the instruction sheet for detailed rivet nut installation instructions.

FIGURE 10



23. Place the machined sleeve into the existing frame rail hole. Reinstall the bracket with hardware (#788) and sleeve as shown. Due to variations in the factory brackets, shims are included to go between the bracket and transmission crossmember to take up the slack. Drop the shims in from the top. There are (2) 1/8" shims and (2) 1/16" shims included. Shims may need to be stacked. (Fig. 11a-g)

FIGURE 11A



FIGURE 11B

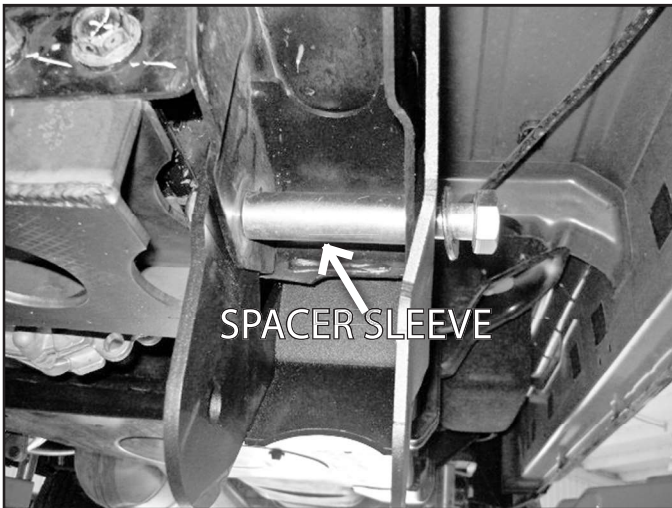

FIGURE 11D

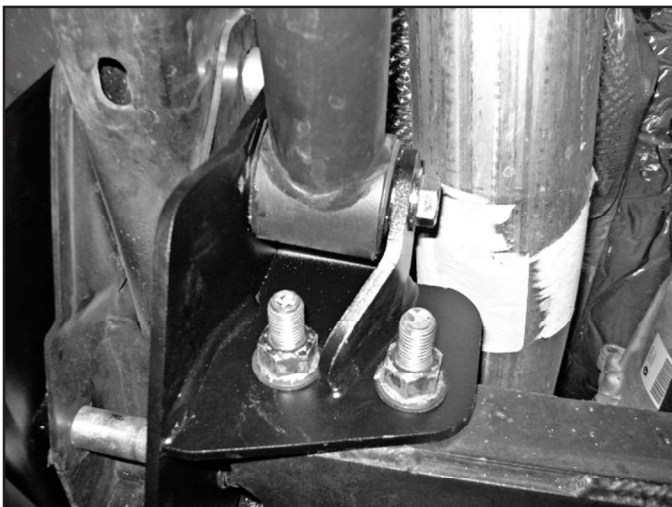

FIGURE 11C

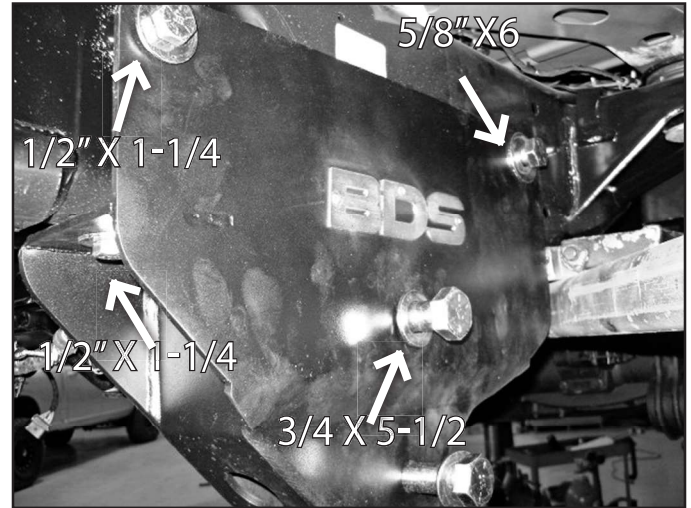

FIGURE 11E



FIGURE 11F

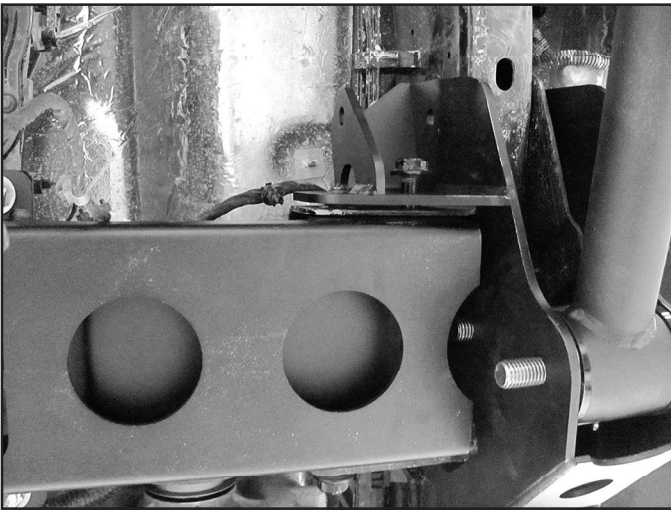

FIGURE 11G

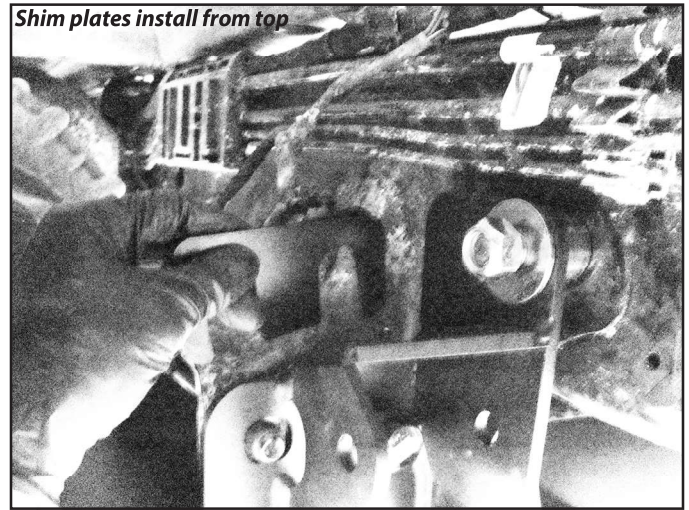

FIGURE 11H

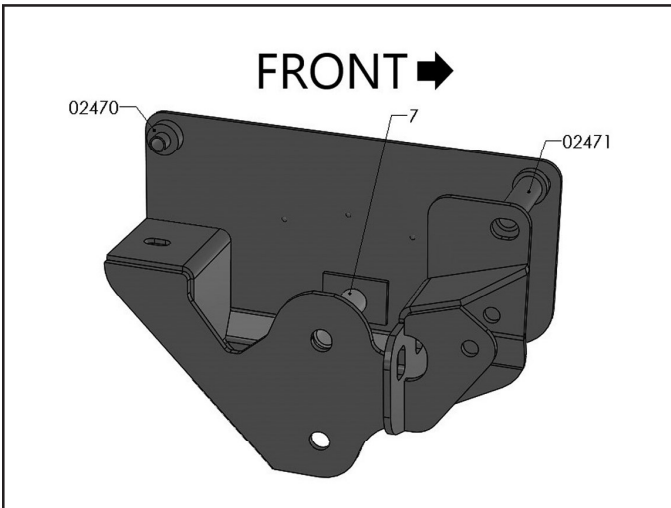
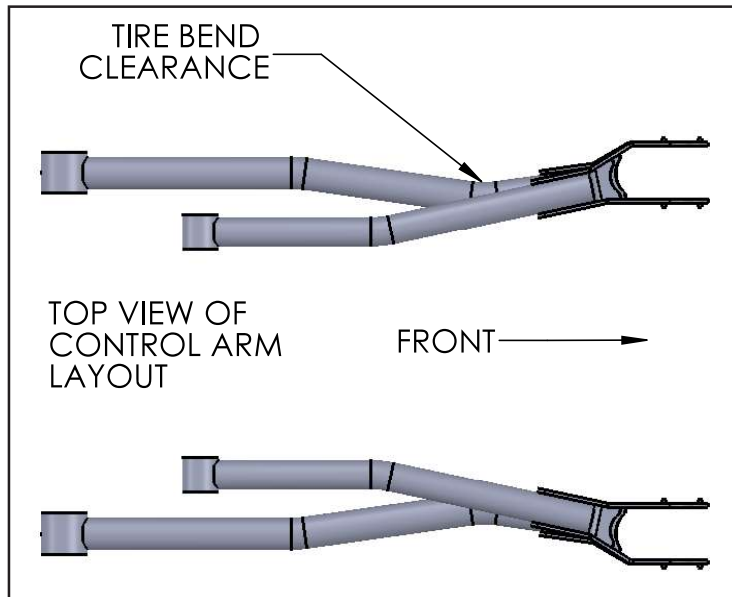

FIGURE 11I



24. Grease and install bushing and sleeves into the lower control arm. Thread the grease fitting into the arm.
25. With a jack still under the axle, disconnect the radius arm from the driver's side frame bracket. Install the new upper and lower control arm on the passenger's side. The upper arm will get 9/16" x 4" hardware, the lower will get 3/4" x 5" hardware. The factory hardware is used at the axle. It is recommended to knock the nut tabs from the factory nuts to allow for quick torque of the hardware with the shocks in place later in the installation. Place a large socket over the nut and press off the tab in a vice. Note: The lower arm is curved inward for tire clearance. Both the upper and lower arms will have the part #'s stamped on them and the part #'s will face in towards the center of the vehicle. (Fig 12)

FIGURE 12



26. Tighten hardware as follows: 1/2" 65ft-lbs, 5/8" through the frame bolt 110 ft-lbs, 3/4" through the factory radius arm mount: 180 ft-lbs. Do NOT tighten the control arm hardware at this time, final torque will be done with the weight of the vehicle on the ground.
27. Repeat bracket and arm installation procedure on the driver's side. The driver's side will require the transmission crossmember bolt that is closest to the frame rail to be ran from front to rear for upper arm clearance.



Tip *The trimming for clearance on the frame bracket is not required on the driver's side.*

28. Rotate the cam to the position marked at the beginning of the installation. Snug all hardware, do not tighten at this time.

BUMP STOP INSTALLATION:

29. Remove the factory bump stops, it is easiest to hit them from side with a hammer to pop them out. (Fig. 13a)

FIGURE 13A



30. Located the 2 existing holes in the frame rail inside the factory bump stop cup. If these holes do not exist, they must be drilled out to 21/64", use the bump stop extension as a guide for drilling the holes. Use the 3/8" self threading bolts to cut new threads into the frame rail, impact gun highly recommended (Fig 13b). Attach bump stop to bracket with washer, lock washer, and regular nut, tighten securely. Attach bracket with 3/8" x 2" bolts with washers, tighten to 30 ft-lbs. (Fig 13c) Hardware is in bolt pack # 785. Note: On the passenger's side only, there may be interference with the factory plate, this small amount will need to be trimmed off for clearance to the bump stop bracket if the bracket can not sit flush.

FIGURE 13B



FIGURE 13C

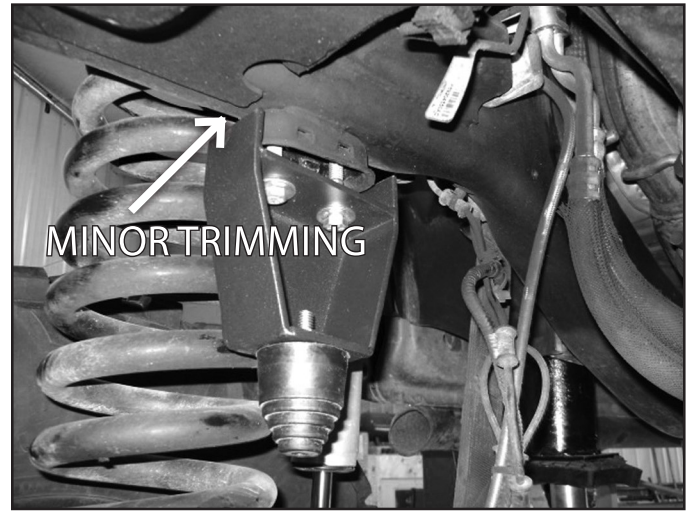

TRACK BAR BRACKET INSTALLATION

31. Install the trackbar bracket (#02988) with factory bolt through the original trackbar hole.
32. Clearance the factory hole on the frame crossmember where the trackbar bracket meets to 9/16".
33. The upper slot in the trackbar bracket will align with the hole in the factory trackbar bracket. These holes have variations in their position, and minor grinding of the factory hole may be required. Clearance the hole so 1/2" hardware will fit through it. (Fig. 14)

FIGURE 14



34. Fish the bolt tabs through the frame rail hole with the included bolt wire and attach to the trackbar bracket with 1/2" USS washer and regular nut (BP 831). (Fig. 15a). Apply thread locker to the bolt threads. Attach the upper hole with 1/2" x 1-3/4 (BP 831) bolt shown. (Fig. 15b)

FIGURE 15A

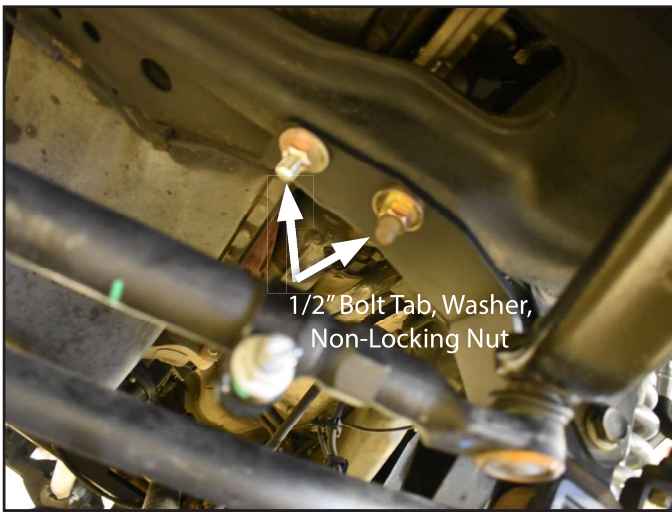
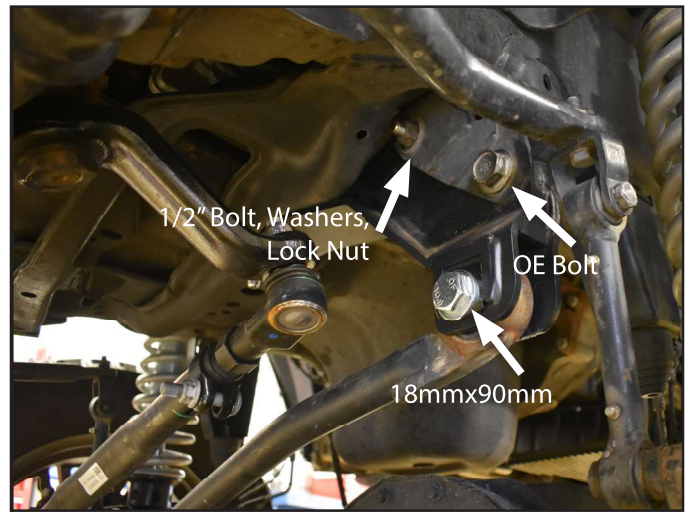

FIGURE 15B



- 35. Tighten 1/2" trackbar hardware to 65 ft-lbs. Tighten 18mm factory bolt to 250 ft-lbs.
- 36. Support front axle and remove the factory shocks. Retain the lower hardware, discard shocks and upper hardware.
- 37. Lower the axle and install the new coils with factory isolator. The Driver's side coil will install with the isolator tab in the factory hole. The Passenger's side isolator will need to be rotated just over 45 degrees. Cut and place the template up to the factory mount, mark hole center and drill to 1/2". The upper isolator on the passenger's side is shown in the new hole. (Fig 16a, 16b, 16c, 16d) ONLY on the passenger's side.

FIGURE 16A - TEMPLATE



FIGURE 16B

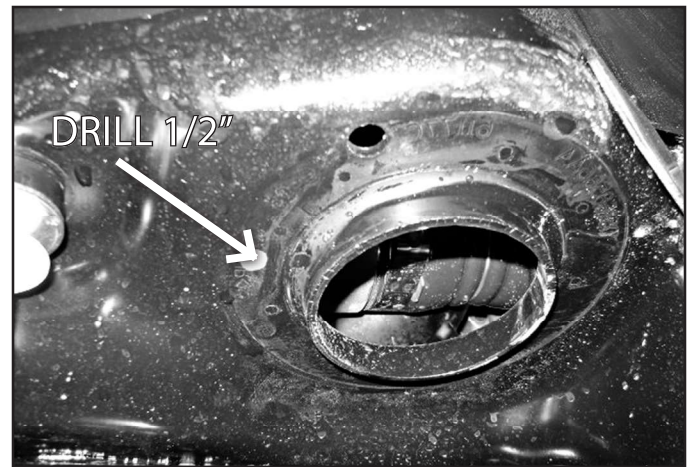

FIGURE 16C - INCORRECT



FIGURE 16D - CORRECT



- 38. Grease and install bushings and sleeves into the shocks. Install new shocks with cup washers, bushings, and 1/2" nut at the top mount. Tighten the nut until the bushings begin to swell.
- 39. Attach the lower shock with factory hardware. Tighten hardware to 65 ft-lbs.

STEERING MODIFICATION

40. Disassemble the drag link. Trim the tab from the tie rod end flush with the end of the threads (Fig 16a, 16b). Trim the end of the tab on the drag link to 1-1/4" long. (Fig. 17A-C).

FIGURE 17A

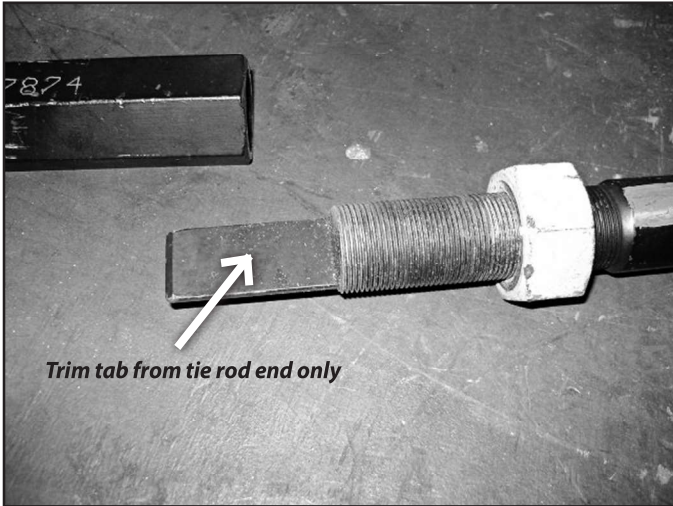
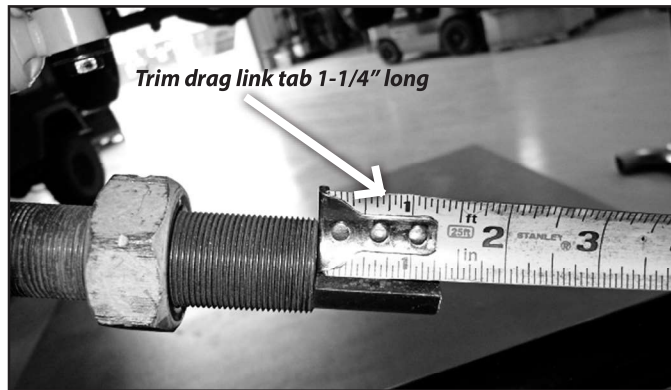

FIGURE 17B

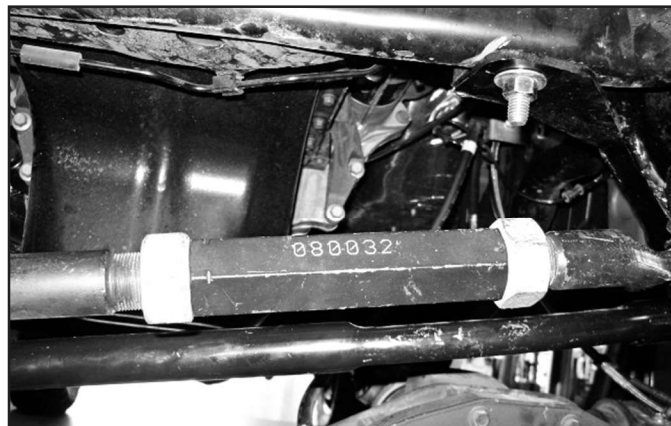

FIGURE 17C



41. Reassemble the drag link, adjust so that there is approximately 3/4"~7/8" of thread exposed past the jam nuts and that the tie rod end faces up. (Fig. 18A)

FIGURE 18A



42. Install new pitman arm, use alignment mark made earlier. The included pitman arm can be installed in 2 different positions. Ensure that the pitman arm is installed in the most counter clockwise position (towards the driver side) as shown in (Fig. 18B). Loctite factory nut and install with lock washer tighten nut to 225 ft-lbs.

FIGURE 18B



43. Install new sway bar links. The clevis bracket will be a tight squeeze to get over the factory sway bar (keeps it from rotating). It may be necessary to slightly clear the widest part of the sway bar to get the bracket to fit over it. Attach with hardware as shown. (Fig 19a, 19b, 19c, & 19d). Torque upper 10mm button head bolts to 30 ft-lbs, lower 14mm bolt to 88 ft-lbs.

FIGURE 19A



FIGURE 19B



FIGURE 19C

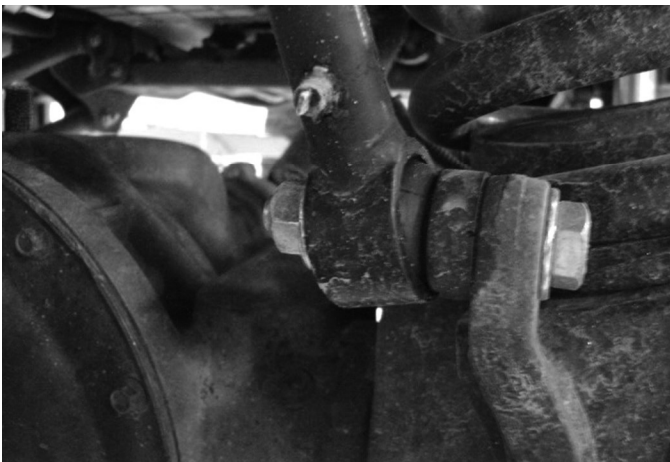
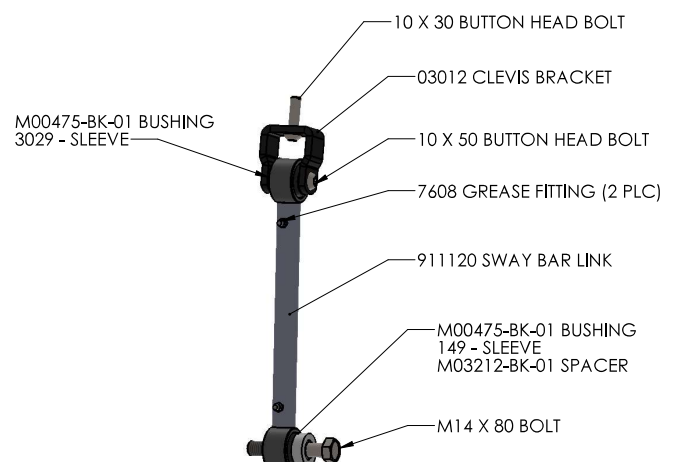
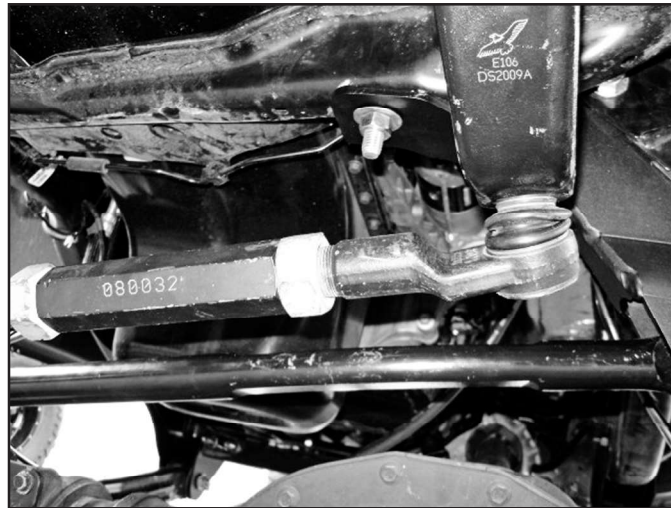

FIGURE 19D



44. Attach drag link to pitman arm with factory nut. Tighten to 65 ft-lbs. (Fig. 20)

FIGURE 20



45. Route and attach the brakeline to the axle with factory hardware and clamps. (Fig 21)

FIGURE 21



46. Reattach the front driveshaft to the front axle with factory hardware and thread locker. Tighten to 75 ft-lbs.
47. Install wheels and tighten lug nuts to factory specifications. Lower the vehicle to the ground.
48. Tighten 4-link hardware as follows: 18mm stock hardware at axle to 180 ft-lbs. 3/4" Lower hardware at 4-link bracket: 180 ft-lbs. 9/16" Upper arm hardware: 95 ft-lbs.
49. Turn the steering wheel to get the trackbar to align with the bracket. Install new 18mm bolt with cams and tighten to 250 ft-lbs (#789). Adjust cam so that the bolt is closest to the passenger's side (Fig 22). The cam can be rotated to center the axle to accommodate variations in trucks.

FIGURE 22



50. The front brakes must be bled, do so at this time.
51. The badge can now be riveted on to the 4-link brackets using the provided 1/8" rivets. Any residue on the badge can be cleaned up using alcohol or brake cleaner before install. With the badge not installed it can be painted to what ever color you desire, or left raw as a stainless steel badge.

(2500 TRUCKS SEE SEPARATE REAR INSTRUCTION SHEET)

REAR INSTALLATION FOR 3500 TRUCKS WITH LEAF SPRINGS

52. Raise the rear of the vehicle, block the front wheels for safety. Support the frame rails with jackstands.
53. Disconnect e-brake cable and reroute the line to give adequate slack in the cable at full droop, reattach once routed for extra slack. (Fig. 23a, 23b) Reattach once rerouted.

FIGURE 23A

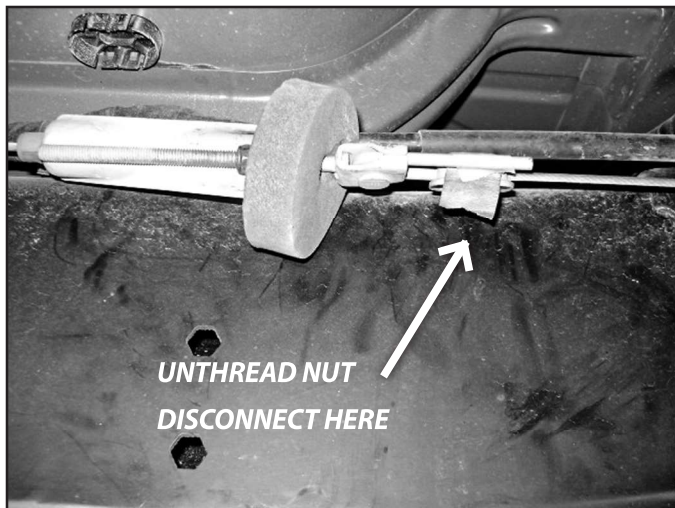

FIGURE 23B



54. Remove the factory shocks, retain all mounting hardware.
55. Disconnect the brake line brackets from the top of the axle to allow maximum droop without overextending the brake lines.
56. Support the rear axle with a hydraulic jack. Remove the u-bolts and plates from one side of the vehicle only. Loosen the u-bolts, but do not remove the opposite side.

REPLACEMENT SPRING INSTALLATION ONLY (DUAL ADD-A-LEAF SKIP AHEAD #59):

57. Lower the axle and remove the stock leaf spring with shackle. Transfer shackle over to new leaf spring and reinstall the entire assembly. Do NOT tighten any of the 3 bolts that attach to the spring or shackle at this time, make sure the shackle bolt is orientated correctly (inside - out). (Fig 24a, 24b)

FIGURE 24A



FIGURE 24B



58. Install new 2" lift block BACKWARDS (large end in front - small towards rear) with new u-bolts and install the nuts, snug but do not tighten at this time. Note: the new u-bolts are 5/8", which means they are larger and stronger than factory 14mm. The factory leaf spring plate will need to be modified to clear the u-bolts. Grind or drill out the mounting plates slightly for adequate clearance.
59. Repeat spring, block, and u-bolt installation on opposite side of the vehicle.

DUAL ADD-A-LEAF INSTALLATION:

60. The installation can be performed with the leaf springs remaining installed in the truck, but extra care must be used to ensure that cables / wires are not over extended.
61. Lower the axle on the side with the u-bolts removed.
62. Trim the leaf spring clamps near where they bend over to allow the leafs to be disassembled.
63. Clamp the leaf pack together with c-clamps, remove the dual center pins.
64. Loosen the clamps and allow the leaf pack to disassemble. Remove the lowest block off the leaf pack, remove the plastic center pin and replace it with the metal one (#01599) provided in the kit. Use a hammer, vice, or press to install the new metal pin.
65. The main leaf and the leaf, leaf with clamps, and factory overload leaf will all be reused. There will be one leaf that is not intended to be reused, however, it is possible to reinstall this leaf if the user desires.
66. Reassemble pack with new leafs with new center pins. Note: Overload applications will not reuse overloads. (Fig 24c, 24d)

FIGURE 24C



FIGURE 24D



67. Lower axle enough to install new block with the bump stop wing facing in. If installing air bags, the wing will need to face towards the caliper side of the wheel to allow for clearance.
68. Raise axle and attach with new u-bolts with factory spring plate. The u-bolts are 5/8" diameter, which are larger than the stock 9/16", use a rotary die grinder to enlarge the holes in the factory spring plate. Repeat installation on opposite side.

FINAL REAR ASSEMBLY:

69. Tighten u-bolts snugly at this time, do not torque until the vehicle is on the ground.
70. Grease bushings and sleeves, install them into both ends of the shocks. Install new shocks with factory hardware. Tighten to 65 ft-lbs. If installing optional Fox shocks, the body will be located at the frame mount.
71. Install 'L' shaped bracket to the top of the axle with factory hardware. Carefully reform the factory hard lines for adequate routing. Attach brake line bracket to 'L' bracket with 1/4" x 3/4" hardware (#768) (Fig 25a, 25b)

FIGURE 25A



FIGURE 25B

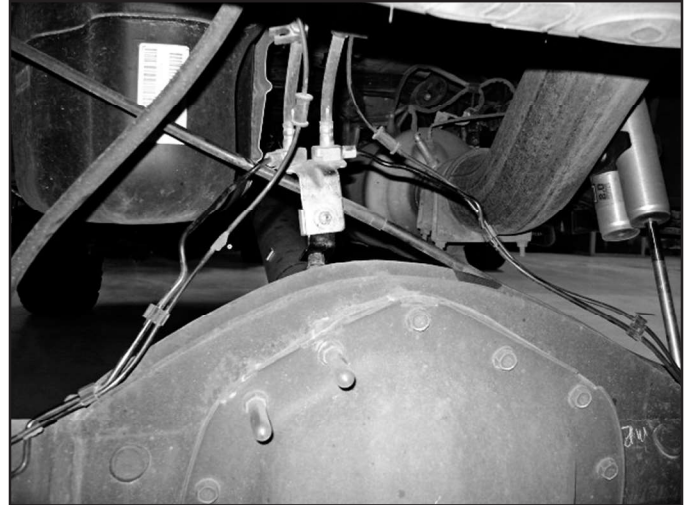

72. Reinstall wheels, torque to specification. Lower vehicle to the ground and torque u-bolts to 140 ft-lbs.
73. Tighten leaf spring and shackle hardware. Front mount: 250 ft-lbs Rear Spring to Shackle: 150 ft-lbs Shackle to Frame: 150 ft-lbs.

POST-INSTALLATION

1. Adjust the steering wheel to center with the collar on the drag link. Securely lock off the jam nuts once the wheel is straight. Do not drive the vehicle with the steering wheel off-center or adverse traction control problems may arise.
2. Recheck all hardware, check again at 500 miles, and again at regularly scheduled maintenance intervals. Check brake lines and ABS wires for proper clearance through steering sweep, use zip ties on the ABS wires if necessary. An alignment must now be performed.
3. These trucks can have a vibration from the factory under load and at extremely low RPM's (less than 1200 RPM's), the vibration can become more apparent after lifting the rear of the truck. There is an optional rear driveshaft spacer kit available (Part# 122007). This will increase rear driveshaft spline engagement and has been found to reduce vibration in rare instances where a vibration is present.
4. Carrier bearing drop is available separately, and is not included in the kit. Order separately if required.

RIVET NUT INSTALLATION INSTRUCTIONS

RIVET NUT SIZING

1. Verify the correct size rivet nut for the application based on the thickness of material where the rivet nut is to be installed using the following chart.

Part Number	Thread Size	Body Length (in)	Material Thickness (in)		Drill Size (in)
			Min.	Max.	
95105A159	3/8-16	.690	.027	.150	17/32
95105A168	3/8-16	.805	.150	.312	17/32
95105A169	1/2-13	1.150	.063	.200	11/16
95105A170	1/2-13	1.300	.200	.350	11/16

HOLE PREPARATION

2. Drill hole to appropriate size for rivet nut installation. 1/2" Rivnuts require an 11/16" hole and 3/8" Rivnuts require a 17/32" drill. It is critical that this hole is drilled to the correct size. Remove any burrs that could keep the rivet nut from seating flat against either side of the hole surface.



Tip *If the correct drill size is not available, it is possible to drill the hole to an available smaller size and slowly grind it out to until the rivet nut fits tight.*

RIVET NUT INSTALLATION TOOL ASSEMBLY

3. For a 3/8" rivet nut, place the provided 3/8" SAE flat washer on the 3/8" x 1-1/2" bolt, followed by 7/16" hex nut and then a 3/8" serrated washer. (Fig. 1) Thread this tool assembly into the rivet nut.
4. For a 1/2" rivet nut, place the provided 1/2" SAE washer on a 1/2" x 2" bolt followed by a 9/16" high nut and 1/2" serrated edge lock washer. Thread this tool assembly into the rivet nut as shown. (Fig. 1)

FIGURE 1- 1/2" RIVET NUT SHOWN

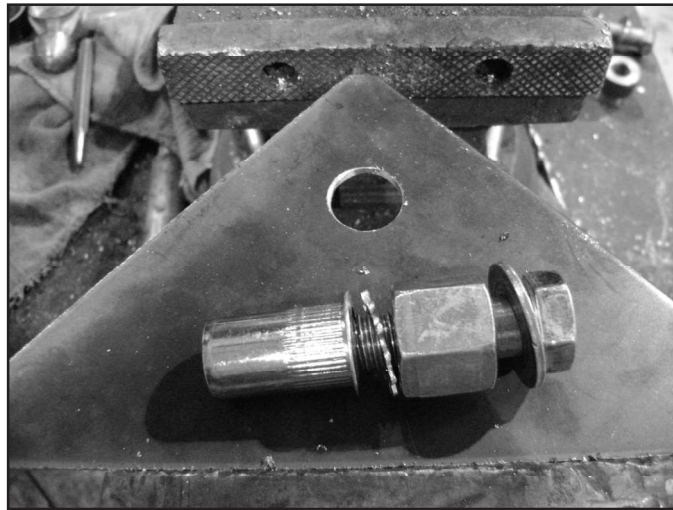

RIVET NUT INSTALLATION

5. Place the installation tool with the rivet nut threaded on the end into the appropriately sized hole.
6. For a 3/8" rivet nut, hold the nut closest to the rivet nut still with a 5/8" wrench and tighten the 3/8" bolt with a 9/16" wrench to set the rivet nut. Be sure to hold the rivet nut flush to the surface and square to the hole as it is tightened. (Fig. 2)



Tip *If available, an impact gun is recommended for tightening the bolt to ensure the rivet nut remains square to the hole and to ease holding the nut from spinning.*

7. For a 1/2" rivet nut, hold the nut closest to the rivet nut still with a 7/8" wrench and tighten the 1/2" bolt with a 3/4" wrench to set the rivet nut. Be sure to hold the rivet nut flush to the surface and square to the hole as it is tightened. (Fig. 2)

FIGURE 2 - 1/2" RIVET NUT SHOWN



TORQUE SPECIFICATIONS

- 3/8" rivet nuts will approach 40 ft. lbs for maximum grip strength. Do not exceed 45 ft-lbs when setting the rivet nut.
- 1/2" rivet nuts will approach 90 ft lbs for maximum grip strength. Do not exceed 100 ft-lbs when setting the rivet nut.



Tip

If using the recommended impact gun, use caution to not exceed the recommended torque specifications.

RIVET NUT TOOL REMOVAL

- Once the center bolt is tightened, remain holding the nut from spinning with the wrench and loosen the center bolt to remove the installation tool.



Caution

It is very important to hold the nut as the bolt is loosened because the grip of the star washer will try to spin the rivet nut and ruin the installation.

- Verify proper installation by checking for consistent rivet nut deformation to see the threads are square and centered to the rivet nut. (Fig. 3)

FIGURE 3



WE WANT TO SEE YOUR RIDE!

Grab photos of your BDS-equipped truck in action and send them in for a chance to be featured. Send it in to our Bad Ass Rides customer gallery at bds-suspension.com/bar and post them on the BDS Fan Page on Facebook at facebook.com/BDSSuspensions. Don't forget about your BDS swag! BDS offers t-shirts, hoodies, decals and more available on the BDS website or through your local BDS distributor.

TIME TO HAVE SOME FUN

Thank you for choosing BDS Suspension.

For questions, technical support and warranty issues relating to this BDS Suspension product, please contact your distributor/installer before contacting BDS Suspension directly.

