

INSTALLATION GUIDE

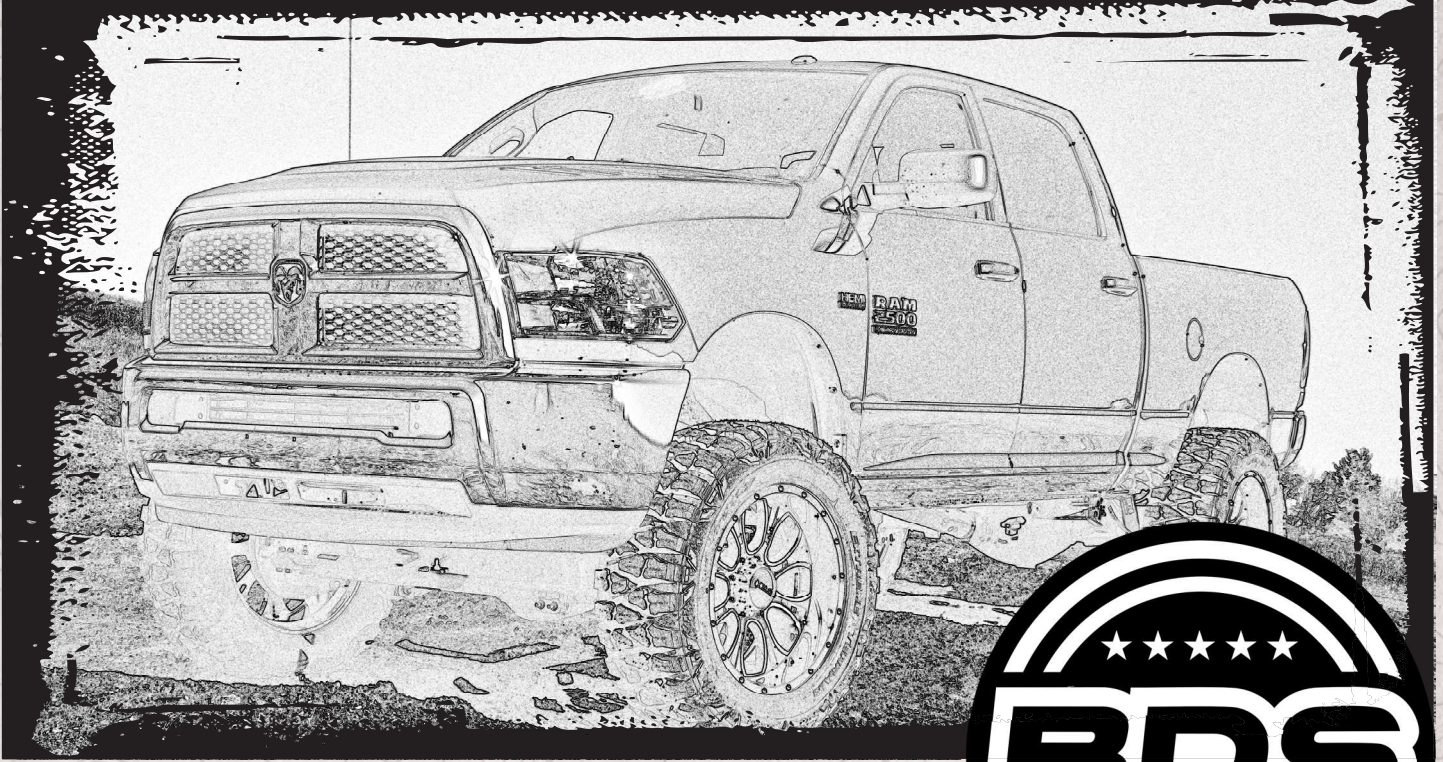

Part#: 012257, 012359, 012529

HARDCORE LIMITED LIFETIME WARRANTY

3.5" & 5" Rear Air Ride Lift Systems

Dodge 2500 Pickup | 2014-18

2.5" Rear Air Ride Lift Systems

Dodge 2500 Pickup | 2014-21

491 W. Garfield Ave., Coldwater, MI 49036 • Phone: 517-279-2135

Web: www.bds-suspension.com • E-mail: tech-bds@ridefox.com

Rev. 032923

Read And Understand All Instructions And Warnings Prior To Installation Of System And Operation Of Vehicle.

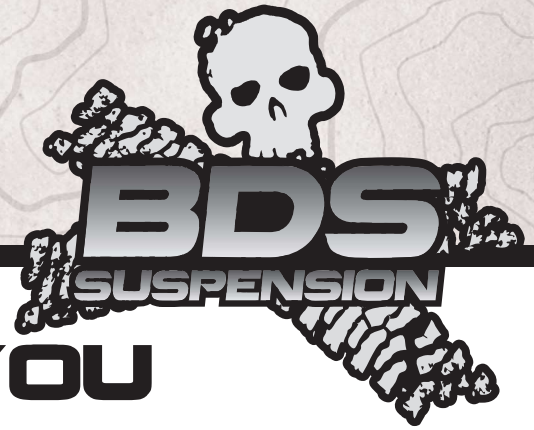

THANK YOU

Your truck is about to be fitted with the best suspension system on the market today. That means you will be driving the baddest looking truck in the neighborhood, and you'll have the warranty to ensure that it stays that way for years to come. Thank you for choosing BDS Suspension!

BEFORE YOU START

BDS Suspension Co. recommends this system be installed by a professional technician. In addition to these instructions, professional knowledge of disassembly/ reassembly procedures and post installation checks must be known.

FOR YOUR SAFETY

Certain BDS Suspension products are intended to improve off-road performance. Modifying your vehicle for off-road use may result in the vehicle handling differently than a factory equipped vehicle. Extreme care must be used to prevent loss of control or vehicle rollover. Failure to drive your modified vehicle safely may result in serious injury or death. BDS Suspension Co. does not recommend the combined use of suspension lifts, body lifts, or other lifting devices. You should never operate your modified vehicle under the influence of alcohol or drugs. Always drive your modified vehicle at reduced speeds to ensure your ability to control your vehicle under all driving conditions. Always wear your seat belt.

BEFORE INSTALLATION

Special literature required: OE Service Manual for model/year of vehicle. Refer to manual for proper disassembly/reassembly procedures of OE and related components.

Adhere to recommendations when replacement fasteners, retainers and keepers are called out in the OE manual.

Larger rim and tire combinations may increase leverage on suspension, steering, and related components. When selecting combinations larger than OE, consider the additional stress you could be inducing on the OE and related components.

Post suspension system vehicles may experience drive line vibrations. Angles may require tuning, slider on shaft may require replacement, shafts may need to be lengthened or trued, and U-joints may need to be replaced.

Secure and properly block vehicle prior to installation of BDS Suspension components. Always wear safety glasses when using power tools.

If installation is to be performed without a hoist, BDS Suspension Co. recommends rear alterations first.

Due to payload options and initial ride height variances, the amount of lift is a base figure. Final ride height dimensions may vary in accordance to original vehicle attitude. Always measure the attitude prior to beginning installation.



Visit 560plus.com for more information.

BEFORE YOU DRIVE

Check all fasteners for proper torque. Check to ensure for adequate clearance between all rotating, mobile, fixed, and heated members. Verify clearance between exhaust and brake lines, fuel lines, fuel tank, floor boards and wiring harness. Check steering gear for clearance. Test and inspect brake system.

Perform steering sweep to ensure front brake hoses have adequate slack and do not contact any rotating, mobile or heated members. Inspect rear brake hoses at full extension for adequate slack. Failure to perform hose check/ replacement may result in component failure. Longer replacement hoses, if needed can be purchased from a local parts supplier.

Perform head light check and adjustment.

Re-torque all fasteners after 500 miles. Always inspect fasteners and components during routine servicing.

CONTENTS OF YOUR KIT

Rear Air Bag Spacer Box Kit (012257, 012359, 012529)		
Part #	Qty	Description
03857	1	Rear Track Bar Bracket
145	1	Track Bar Bracket Sleeve (2-1/8" long)
02496	2	2.5" Air Bag Spacer (012257 only)
02963	2	3.5" Air Bag Spacer (012359 only)
02964	2	5" Air Bag Spacer (012529 only)
159	3	Air Tank Spacer
02961	1	Sensor Bracket - Drv
02962	1	Sensor Bracket - Pass
464	1	Bolt Pack - Air Tank Spacer
	3	8mm x 65mm Bolt
	3	5/16" SAE flat washer
422	1	Bolt Pack
	4	3/8"-16 x 4" bolt
	4	3/8" USS flat washer
	8	3/8"-16 Prevailing torque nut
02965	2	Rear Bump Stop
911112	2	15" Sway Bar Link
SB58BK	4	Hourglass Bushing - EB1
62147	4	5/8" x 12mm ID x 1-.3/8" Sleeve
498	1	Bolt Pack
	1	9/16"-12 x 4" bolt
	2	9/16" SAE Thru-hardened washer
	1	9/16"-12 Prevailing torque nut
	2	7/16"-14 x 1-1/2" bolt
	2	7/16" SAE thru hardened washer
	2	7/16"-14 Serrated flanged nut
359	1	Bolt Pack
	2	6mm-1.00 Nylock Nut, Clear Zinc
	2	6mm-1.00 x 20mm Bolt, Grade 8.8, Clear Zinc
	2	6mm Washer, Clear Zinc
	2	3/8"-16 x 1" Self Tapping Bolt Hex head type 23, Clear Zinc
	4	3/8"-16 x 1" Hex Bolt, Grade 8, Yellow Zinc
	4	3/8"-16 Prevailing Torque Nut, Yellow Zinc
	8	3/8" SAE Washer, Yellow Zinc
	1	8mm-1.25 Nylock Nut, Clear Zinc
	1	8mm Washer, Clear Zinc

Rear Air Bag Spacer Box Kit (012257, 012359, 012529)		
458	1	Bolt Pack
	8	10mm-1.50 x 25mm bolt
	4	10mm-1.50 x Prevailing torque nut
	12	10mm Washer
795	1	Bolt Pack
	2	1/4" USS Washer
	2	5/16"-18 Nylock nut

TROUBLESHOOTING INFORMATION FOR YOUR VEHICLE

1. When installing this rear air ride system in conjunction with a 4-Link or radius arm drop bracket system. Use the provided air tank spacers in this box kit to provide clearance to the brackets.

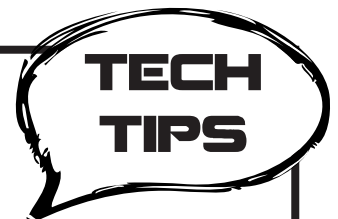

INSTALLATION INSTRUCTIONS

1. Park vehicle on clean flat and level surface. Block front wheels for safety.
2. Disconnect the battery to disable the rear air suspension.
3. Disconnect the rear trackbar from the axle, retain all hardware. (Fig 1)

SPECIAL TOOLS

1/2" Drill



Tip

You may need to detach the vent hose clip from the track bar bracket to prevent the nut tab from puncturing the vent hose.

FIGURE 1



4. Raise rear of vehicle and support frame rails with jack stands.
5. Remove the rear wheels.
6. Support the rear axle with a hydraulic jack.
7. Disconnect the rear sway bar links from the frame and sway bar. (Fig 2a,b)



Tip

Once the nut is loose on the sway bar, use a 8mm socket to tighten the stud and hold the nut with an 18mm wrench as shown in Fig2B

FIGURE 2A

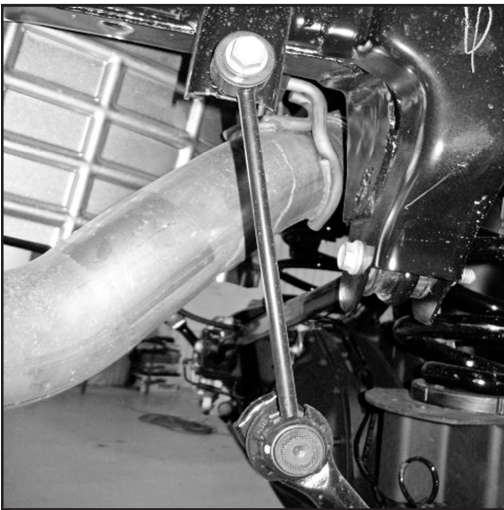
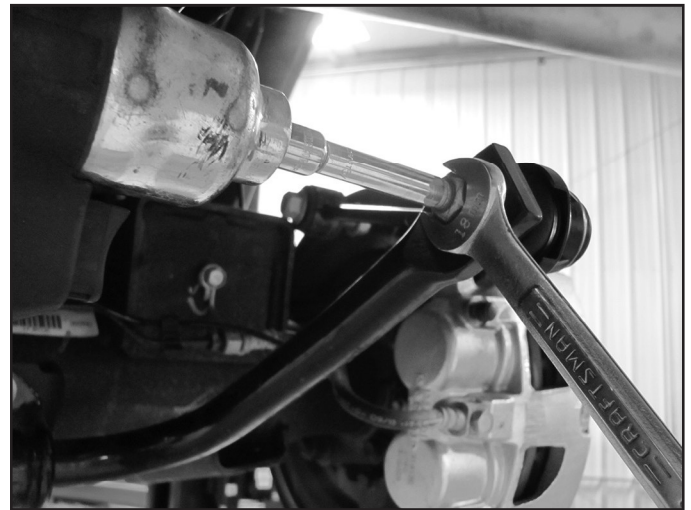

FIGURE 2B



8. Loosen the air fittings at the valve block on the passenger side frame rail to allow the air to bleed from the rear bags (Fig 3).
9. Disconnect the ride height linkage from the axle using a clip tool (Fig 4).

FIGURE 3

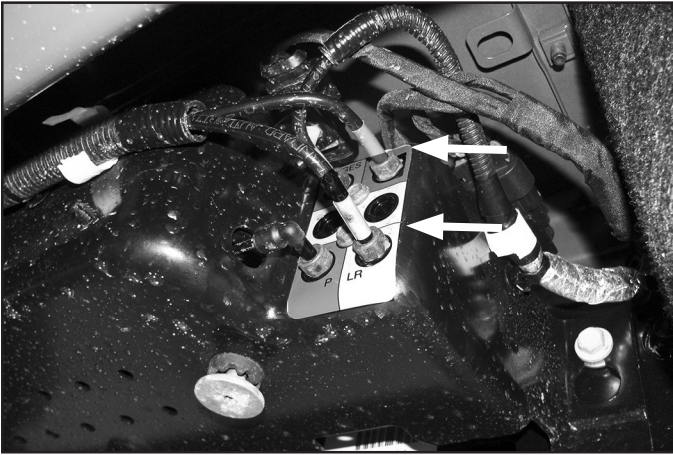
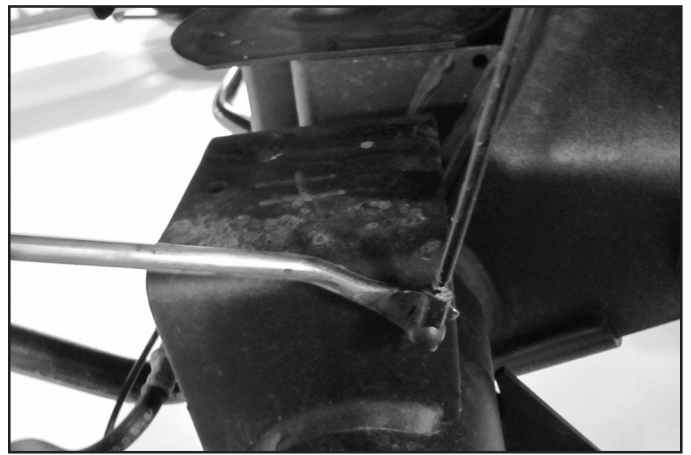

FIGURE 4



10. Disconnect the rear shocks and lower the axle, retain hardware. On the driver's side it is easiest to access the top hardware by cutting the inner fender well as shown. This trim procedure is not required but greatly aids in removal and installation of the shock (Fig 5a, 5b).



Tip

Tip: You may also remove the Inner fender liner if you prefer not to cut and need easier access to the shock nut.

FIGURE 5A



FIGURE 5B



11. Remove the air bag to axle mounting nuts; 2 per side.

FIGURE 6A



FIGURE 6B

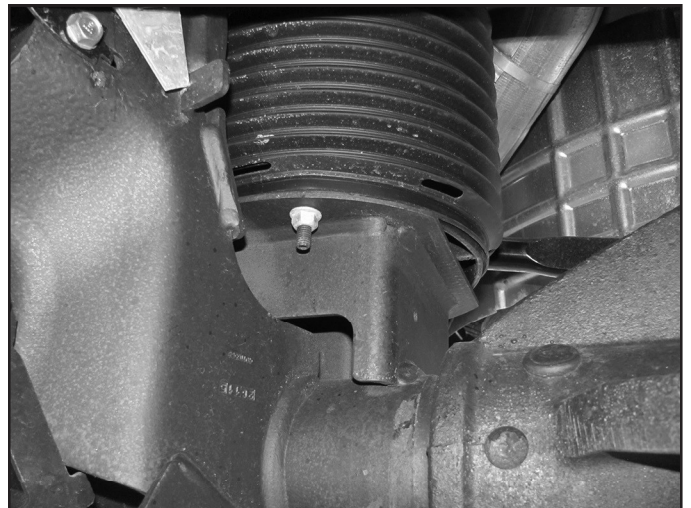

12. Install the rear air bag spacers with 3/8" hardware (BP 359) (Fig. 8). Tighten 3/8" hardware to 35 ft-lbs.

Note: Make sure the air bag spacer is installed correctly with the taper pointing forward.

FIGURE 8



13. Clearance the bottom two holes in the factory track bar bracket with a 1/2" drill bit to accept 7/16" hardware.
14. Install the track bar bracket to the axle. Hardware is located in bolt pack 498. First place the 2-1/8" long sleeve and place it inside the track bar bracket at the factory track bar bolt location using the provided 9/16" x 4" hardware. Using the 7/16" x 1-1/2" bolts, washers, and flange nuts attach the bracket through the bottom holes. (Fig 9A, 9B)

FIGURE 9A

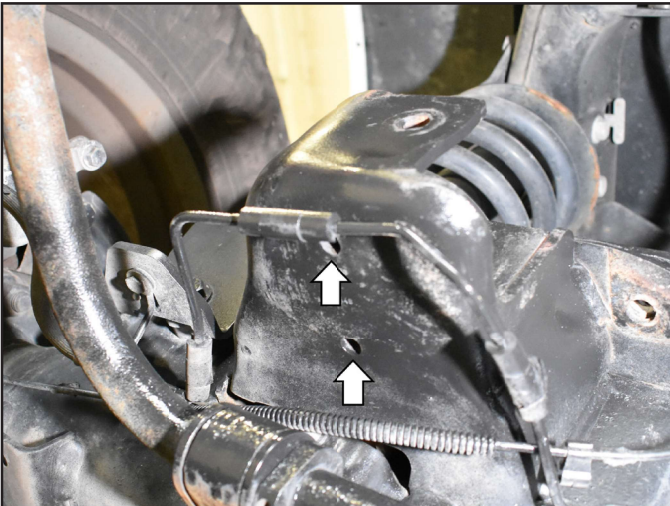
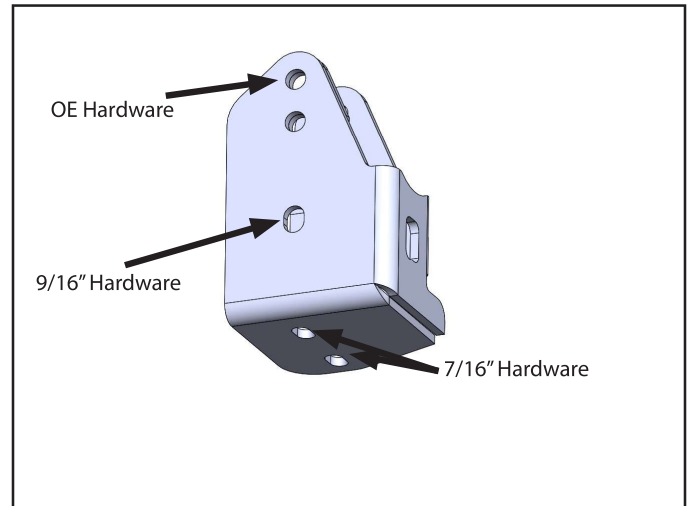

FIGURE 9B



Note: It may be necessary to grind the top of the OE track bar rear mount flange due to vehicle variances.

15. Tighten the track bar bracket hardware as follows: 14mm factory hardware to 140 ft-lbs, 7/16" hardware to 70 ft-lbs.
16. Attach the air bags to the air bag spacers using the factory nuts. An additional nut 8mm nut is provided in bolt pack 359 if not installed from the factory on the driver's side. (Fig 10)

FIGURE 10

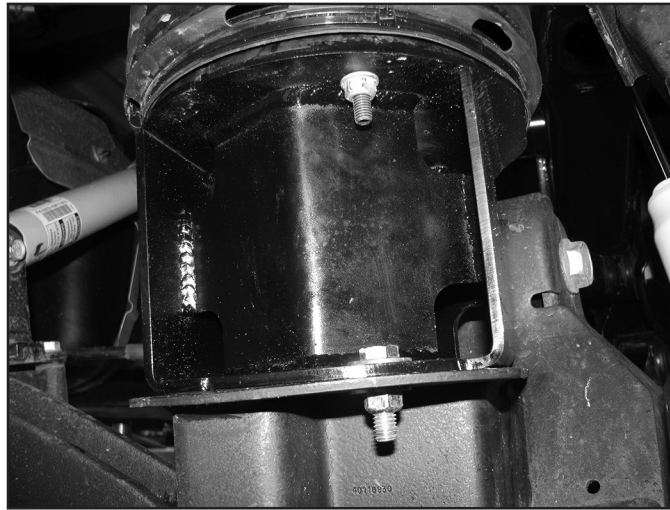

17. **3.5" - 5" Kit Shock Installation:** The shocks will require an offset stem eliminator bracket and bolt pack 946. The eye of the shock will need to be offset to the REAR of the vehicle to give the shock body clearance to the frame rail hole. Locate the OE frame hole towards the rear of the vehicle from the original stem mounting hole. Enlarge this hole using a 3/8" drill bit to fit to the tab on the offset bracket. (Fig. 11)

FIGURE 11



18. Grease bushings and sleeves and install into sway bar links. Install sway bar links with new 12mm hardware. (BP 795). Tighten to 45 ft-lbs. (Fig 12)

FIGURE 12



19. Remove the factory bump stops. from the vehicle.

FIGURE 13

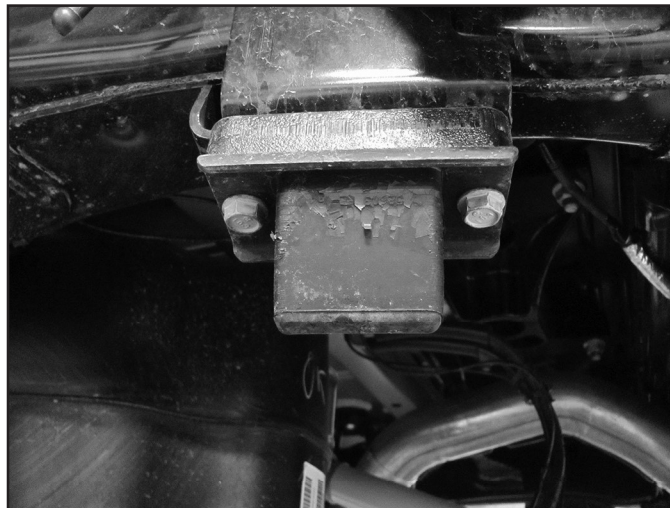

20. **2.5-3.5" Bump Stop Installation:** Install the bump stop drop brackets with new 10mm hardware to the frame (BP 458). Install so the gusseted side faces in and offsets the bump stop towards the center of the vehicle. Using the provided 10mm bolts, nuts, and washers, attached the bump stop directly to the bottom of the drop bracket. The factory spacer will not be used. Tighten to 35 ft-lbs. (Fig 14)
21. **5" Bump Stop Installation:** Install the bump stop drop brackets with new 10mm hardware to the frame (BP 458). Install so the gusseted side faces in and offsets the bump stop towards the center of the vehicle. Using the stock bolts and provided nuts and washers, install the bump stop WITH the factory bump stop spacer to the bottom of the drop bracket. (Fig 14)

FIGURE 14

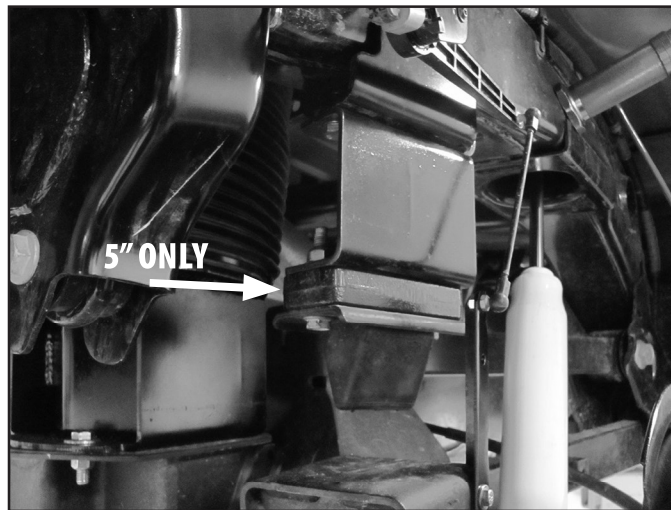

22. Remove ride height sensor linkage stud from the axle (Fig 15).
23. Using the supplied 3/8" self tapping bolt (BP359), thread the holes in front of the bump stop pads (Fig. 15).

FIGURE 15

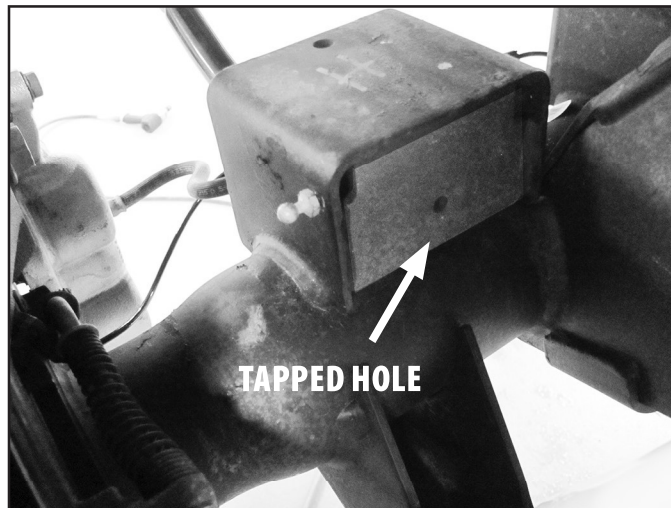

24. Fasten the sensor relocation brackets to the axle with the 3/8" self tapping bolt and provided 6mm bolt and washer (BP 359)

FIGURE 16



25. Attach the factory linkage stud to the linkage bracket with the provided nylock nut (BP359). Use the following image as a guide for your desired ride height. Pop the linkage rod back onto the stud.

FIGURE 17

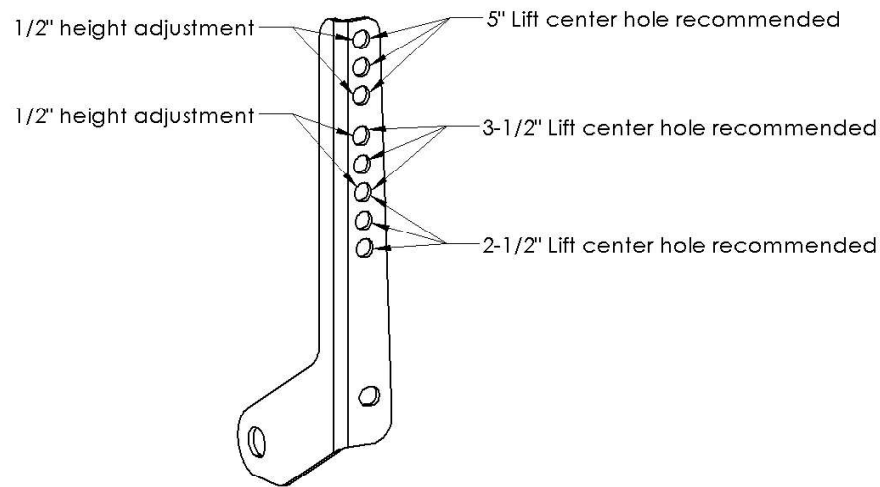

26. If installing a lift with 4-link bracket or radius arm relocation bracket. This box kit contains 3 air tank spacers (159) and bolts to provide bracket clearance. Remove the 3 factory mounting bolts. Insert the spacers between the tank mounts and frame and tighten with the provided hardware (BP 464).
27. Reinstall wheels, if installing aftermarket wheels it is recommended to remove all of the rotor retaining clips to allow the wheel to sit flush against the rotor. Tighten to factory specifications.
28. Lower vehicle to the ground. Ensure the air bags are seated correctly at the frame.
29. Tighten the air fittings at the valve block loosened in Figure 3. The torque spec is 53 in-lbs. Do not overtighten as this could lead to damage to the threads.
30. Cycle the key to the ignition on position until the rear air bags are inflated to the set ride height.
31. Attach track bar to the new bracket with factory trackbar bolt and nut tab. It may be necessary to have an assistant push on one side of the truck slightly to get the holes aligned. Tighten to 95 ft-lbs. 2.5"-3.5" kits use the lower hole, 5" rear kits use the upper hole.
32. Recheck all hardware for proper torque, check again after 500 miles.



WE WANT TO SEE YOUR RIDE!

Grab photos of your BDS-equipped truck in action and send them in for a chance to be featured. Send it in to our Bad Ass Rides customer gallery at bds-suspension.com/bar and post them on the BDS Fan Page on Facebook at facebook.com/BDSSuspensions. Don't forget about your BDS swag! BDS offers t-shirts, hoodies, decals and more available on the BDS website or through your local BDS distributor.

TIME TO HAVE SOME FUN

Thank you for choosing BDS Suspension.

For questions, technical support and warranty issues relating to this BDS Suspension product, please contact your distributor/installer before contacting BDS Suspension directly.