

INSTALLATION GUIDE



Part#: 012433



HARDCORE LIMITED LIFETIME WARRANTY

4" & 6" 4-Link Suspension System

Dodge Ram 3500 Pickup 4WD | 2019-2022

Dodge Ram 2500 Pickup 4WD | 2019-2023

Rev. 042023

491 W. Garfield Ave., Coldwater, MI 49036 • Phone: 517-279-2135

E-mail: tech-bds@ridefox.com

Read And Understand All Instructions And Warnings Prior To Installation Of System And Operation Of Vehicle.

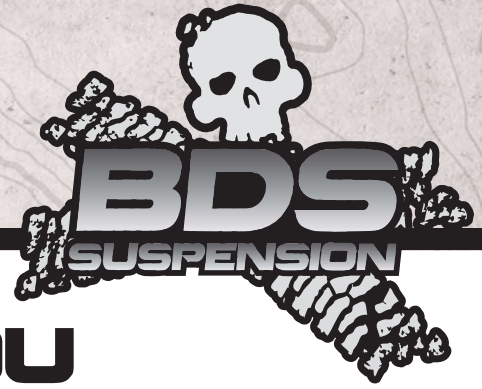

THANK YOU

Your truck is about to be fitted with the best suspension system on the market today. That means you will be driving the baddest looking truck in the neighborhood, and you'll have the warranty to ensure that it stays that way for years to come. Thank you for choosing BDS Suspension!

BEFORE YOU START

BDS Suspension Co. recommends this system be installed by a professional technician. In addition to these instructions, professional knowledge of disassembly/ reassembly procedures and post installation checks must be known.

FOR YOUR SAFETY

Certain BDS Suspension products are intended to improve off-road performance. Modifying your vehicle for off-road use may result in the vehicle handling differently than a factory equipped vehicle. Extreme care must be used to prevent loss of control or vehicle rollover. Failure to drive your modified vehicle safely may result in serious injury or death. BDS Suspension Co. does not recommend the combined use of suspension lifts, body lifts, or other lifting devices. You should never operate your modified vehicle under the influence of alcohol or drugs. Always drive your modified vehicle at reduced speeds to ensure your ability to control your vehicle under all driving conditions. Always wear your seat belt.

BEFORE INSTALLATION

Special literature required: OE Service Manual for model/year of vehicle. Refer to manual for proper disassembly/reassembly procedures of OE and related components.

Adhere to recommendations when replacement fasteners, retainers and keepers are called out in the OE manual.

Larger rim and tire combinations may increase leverage on suspension, steering, and related components. When selecting combinations larger than OE, consider the additional stress you could be inducing on the OE and related components.

Post suspension system vehicles may experience drive line vibrations. Angles may require tuning, slider on shaft may require replacement, shafts may need to be lengthened or trued, and U-joints may need to be replaced.

Secure and properly block vehicle prior to installation of BDS Suspension components. Always wear safety glasses when using power tools.

If installation is to be performed without a hoist, BDS Suspension Co. recommends rear alterations first.

Due to payload options and initial ride height variances, the amount of lift is a base figure. Final ride height dimensions may vary in



Visit 560plus.com for more information.

TIRES AND WHEELS

4" LIFT:

37x13.50 w/ 5.625" Backspacing on 9" wide wheel

37x12.50 w/ 5" Backspacing on 9" wide wheel

6" LIFT:

37x13.50 w/ 5.625" Backspacing on 9" wide wheel

37x12.50 w/ 4.5" Backspacing on 9" wide wheel

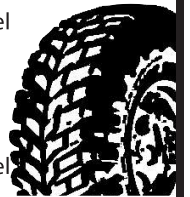

accordance to original vehicle attitude. Always measure the attitude prior to beginning installation.

BEFORE YOU DRIVE

Check all fasteners for proper torque. Check to ensure for adequate clearance between all rotating, mobile, fixed, and heated members. Verify clearance between exhaust and brake lines, fuel lines, fuel tank, floor boards and wiring harness. Check steering gear for clearance. Test and inspect brake system.

Perform steering sweep to ensure front brake hoses have adequate slack and do not contact any rotating, mobile or heated members. Inspect rear brake hoses at full extension for adequate slack. Failure to perform hose check/ replacement may result in component failure. Longer replacement hoses, if needed can be purchased from a local parts supplier.

Perform head light check and adjustment.

Re-torque all fasteners after 500 miles. Always inspect fasteners and components during routine servicing.

CONTENTS OF YOUR KIT

012434 - 4 Link Arms

Part #	Qty	Description
02472	2	Dodge 4-Link Conversion - Lower Control Arm
03842	2	Dodge 4-Link Conversion - Upper Control Arm
3527BK	4	Bushing (Large - Lower Control Arm)
7	2	1.00 x .120 x 3.25 Sleeve
516	2	Straight Grease Zerk
3537BK	4	Bushing (Small - Upper Control Arm)
61	2	.875 x .156 x 2.62 Sleeve
60107	2	90Deg Grease Zerk

012433- 4 Link Brackets

Part #	Qty	Description
03839	1	4-Link Bracket - DRV
03840	1	4-Link Bracket - PASS
02322BK	2	Bump Stop
03816	1	Front Track Bar Bracket
082405R	1	Pitman Arm
02470	2	Weld in Bung
02471	2	Machined 4-link Sleeve
03855	1	Brake Line Bracket - Drv
03856	1	Brake Line Bracket - Pass
03965	2	Sway Bar Drop Bracket
7	2	3-1/4" Sleeve
159	8	Vibration Dampner (Gas Models Only)
03966	4	Cam Plates
02449	2	BDS Badges
86-6277	1	CV Boot Large
86-6276	1	CV Boot Small
95105A169	2	1/2-13 Rivet Nut
360	2	Bolt Pack (Badge)
	3	1/8" SS Rivets
358	1	Bolt Pack (Cam Plates)
	2	18mm-2.50 x 140mm Bolt, Clear Zinc
	4	18mm Washer, Clear Zinc
	2	18mm-2.50 Prevailing Torque Nut, Clear Zinc
352	1	Bolt Pack (4-Link Bracket)
	2	5/8"-11 x 4-3/4" Bolt, Yellow Zinc
	4	5/8" SAE Washer, Yellow Zinc
	2	5/8"-11 Prevailing Torque Nut, Yellow Zinc
	2	3/4"-10 x 5-1/2" Bolt, Yellow Zinc
	4	3/4" SAE Washer, Yellow Zinc
	2	3/4"-10 Prevailing Torque Nut, Yellow Zinc
	4	1/2"-13 x 1-1/4" Bolt, Yellow Zinc
	4	1/2" USS Washer, Yellow Zinc
	2	14mm-2.00 x 100mm Bolt, Clear Zinc
	4	14mm Washer, Clear Zinc
	2	14mm-2.00 Prevailing Torque Nut, Clear Zinc

012433- 4 Link Brackets

357	1	Bolt Pack (Dampner) (Gas Only)
	8	8mm-1.25 x 60mm, Clear Zinc
	8	5/16" SAE Washer, Clear Zinc
495	1	Bolt Pack (Brake Line Bracket)
	2	1/4" USS Washer, Clear Zinc
	2	5/16"-18 Nylock Nut, Clear Zinc
494	1	Bolt Pack (Track Bar Bracket)
	2	14mm-2.00 x 35mm Bolt, Clear Zinc
	4	14mm Washer, Clear Zinc
	2	14mm-2.00 Prevailing Torque Nut, Clear Zinc
796	1	Bolt Pack (Sway Bar)
	4	10mm-1.50 x 55mm Bolt, Clear Zinc
	4	10mm Washer, Clear Zinc
799	1	Bolt Pack (Rivet Nut)
	1	1/2"-13 x 2" Bolt, Yellow Zinc
	1	1/2" SAE Washer, Yellow Zinc
	1	1/2" Star Washer External Tooth, Clear Zinc
	1	9/16"-18 Hex High Nut, Yellow Zinc

INSTALLATION INSTRUCTIONS

PRE INSTALLATION NOTES:

Gas models will require exhaust modification to clear the front driveshaft. The vehicle can be driven without the front driveshaft to an exhaust shop for modification and reinstalled after modification.

MEASURE FIRST

Measure from the center of the wheel up to the bottom edge of the wheel opening:

LF _____ RF _____

LR _____ RR _____

SPECIAL TOOLS

- #1: Pitman arm puller
- #2: 11/16" drill (step drill highly recommended)
- #3: Welder
- #4: CV Clamp Pliers
- #5: Cutoff Wheel

4-LINK INSTALLATION INSTRUCTIONS

1. Park vehicle on clean flat and level surface. Block the rear wheels for safety.
2. Disconnect the battery / batteries, welding will be required. Do not weld on the vehicle with the batteries connected.
3. Remove the front trackbar bolt from the frame rail. Retain all hardware. (Fig. 1)

FIGURE 1

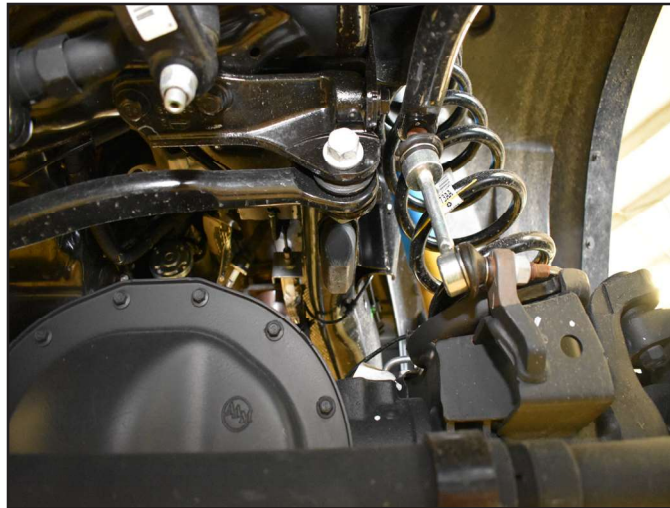

4. Raise the front of the vehicle and support the frame rails with jackstands. Do not support the vehicle by the radius arms, they will be removed during the installation.

SUSPENSION DISASSEMBLY

5. Support the front axle with a hydraulic jack.
6. Remove the factory wheels, remove the retaining clips that hold the rotor on and may interfere with aftermarket wheels.
7. Remove the transmission skid plate (if equipped).
8. Disconnect the front drive shaft from the front axle. Hang the drive shaft from the frame. Retain all hardware

9. Break the nut loose on the adjusting sleeve of the drag link. (Fig. 2)

FIGURE 2



10. Disconnect the drag link tie rod from the pitman arm, do not damage the tie rod boot. Mark the orientation of the pitman arm and remove the pitman arm from the sector shaft. (Fig. 3)

FIGURE 3

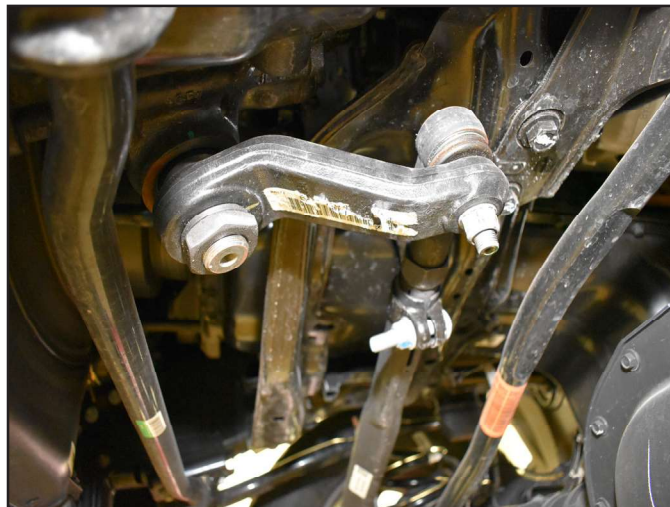

11. Disconnect the sway bar links from the sway bar. Retain all hardware. (Fig. 4)

FIGURE 4

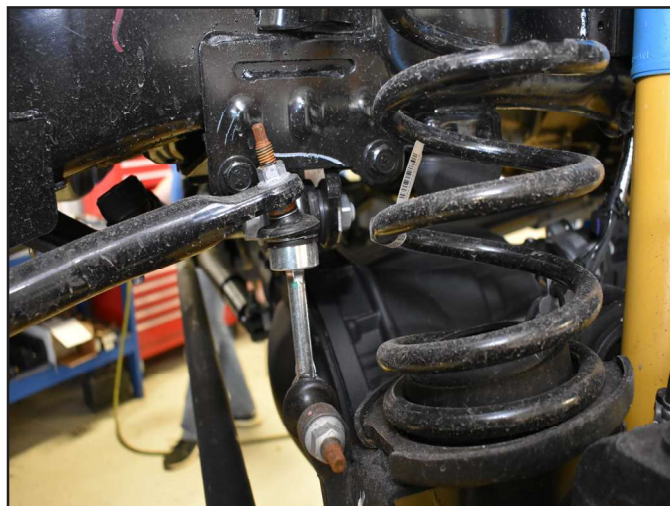

12. Disconnect the brake line bracket from the top of the radius arm mount on the axle, retain bolt and bracket. (Fig. 5)

FIGURE 5

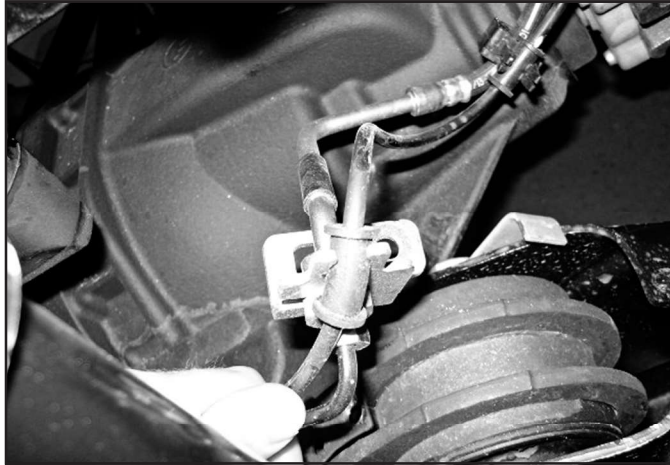

13. Detach the ABS and Central Axle Disconnect wires from retaining clips to allow for extra slack when the new coils will be installed.
14. Disconnect the shock hardware at the lower mounts; keep the lower bolt and nut tab. (Fig 6)

FIGURE 6

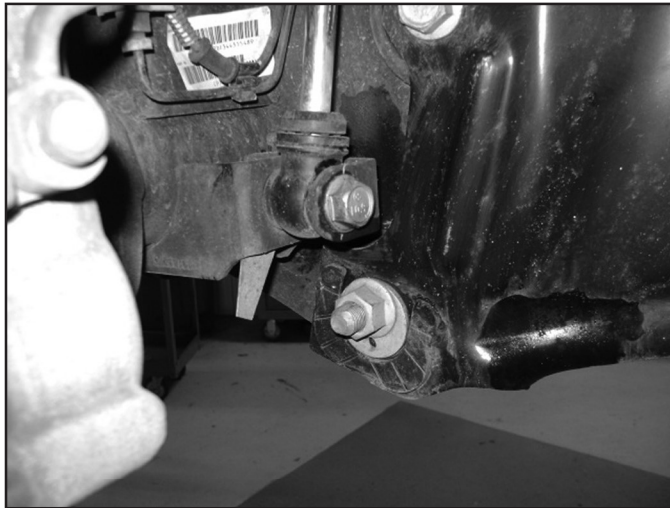

15. Lower the axle and remove the factory coils. Use care not to overextend any brake line, ABS, or CAD wires.
16. Raise the front axle and reattach factory shocks with factory bolt. It is not necessary to put the nut tab back on. The shocks will be there to keep the axle secure. Keep a jack under the axle for extra support.

4-LINK BRACKET INSTALLATION

17. Gas Models Only: Disconnect the two plugs going into the vibration dampner on the outside of the frame rail right behind the front wheels. Unbolt the dampners from the frame. They will be reinstalled later. (Fig 7)
18. Rear Air Ride Models Only: When doing the passenger side you will be required to loosen or unbolt the air tank to get the bracket and hardware installed. Do not disconnect or loosen the air line fitting from the tank.

Note: Disconnecting or loosening the Air Tanks fitting will require the system to be recharged and could require a trip to a dealership for a system reset.

FIGURE 7

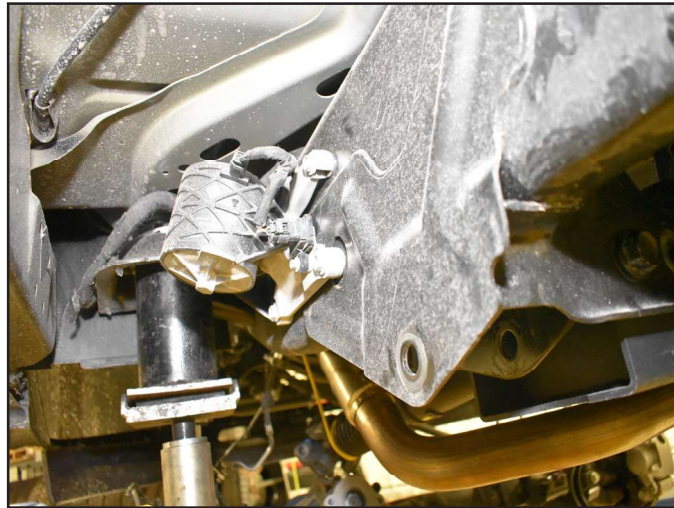

19. Remove the passenger's side radius arm. Retain all hardware. It will be necessary to remove the shock bolt and move the shock out of the way to get the upper hardware out. Reinsert the lower shock bolt when the arm is removed. This is a safety measure to keep the axle from moving an excessive amount.
20. Measure and mark as shown (Fig. 8, 9, 10). This material will need to be removed for clearance for the 4-link drop bracket. Measure back 3-3/8" from the front of radius arm bracket on the frame and make a vertical line. Make a horizontal line about even with the bottom of the frame or 1-1/2" up the vertical line. Use a cut off wheel to remove the material.

FIGURE 8



FIGURE 9



FIGURE 10



21. Mark as shown (Fig. 11), mark the front of the transmission crossmember bracket on the inside of the frame. In front of the weld and along the bottom of the frame. Using a cutoff wheel remove the material marked in the previous step and this step. Ensure you don't cut the frame or cut out the weld holding the crossmember mount brackets together. Paint all bare metal.

FIGURE 11



22. Place the 4-link bracket up to the frame rail. Insert the factory frame radius arm bolt to locate the bracket. Mark the center of the slot on the bottom of the frame rail towards the rear of the vehicle (Fig. 12), then mark the center of the Rear Upward most slot on the outside of the frame. (Fig. 13)

FIGURE 12



FIGURE 13



23. Remove the bracket and drill the 2 center marks to 11/16". Prep the area on the side of the frame rail for welding. Place the supplied weld in bung into the hole and weld the bung into place. (Fig. 14)

FIGURE 14



24. Insert a rivet nut into the bottom of the frame rail. Use the hardware (Bolt Pack #799) to set the rivet nut into place as shown (Fig. 15). See the end of the instruction sheet for detailed rivet nut installation instructions.

FIGURE 15



25. Place the machined sleeve into the existing frame rail hole towards the front of the vehicle. Reinstall the bracket with hardware (Bolt Pack #352) and sleeves as shown (Fig. 16). Place the 3-1/4" long spacer in the factory radius arm pocket and mount the 4-link bracket with provided 3/4" hardware (Fig. 17, 18). Using the provided 1/2" hardware, bolt the bracket to the previously installed riv nut and weld in bung. Slide the provided 5/8" bolt through the bracket and machined sleeve. (Fig. 18) Leave all hardware loose.

FIGURE 16



FIGURE 17

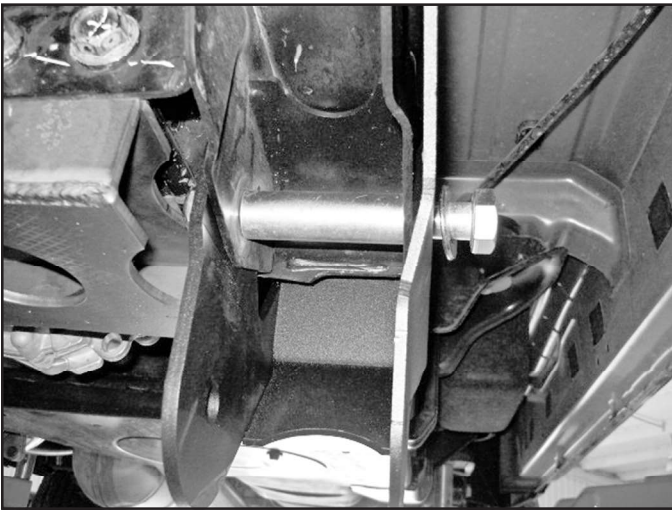

FIGURE 18

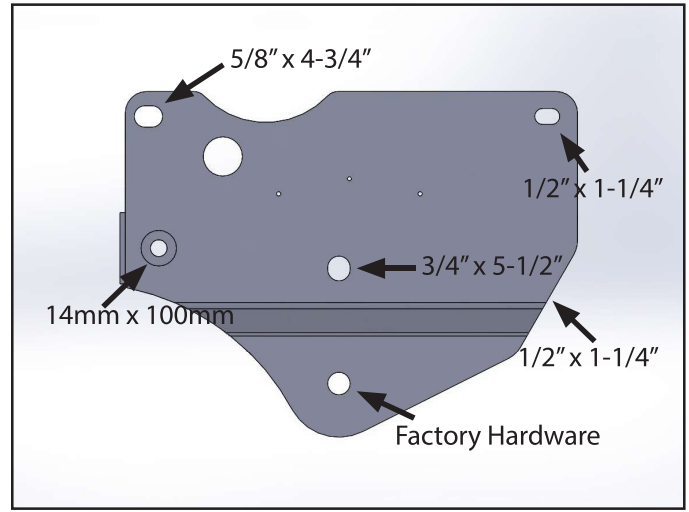

FIGURE 19

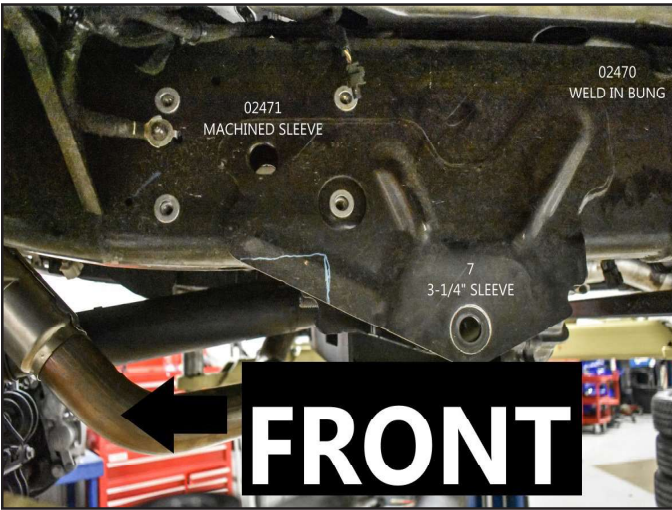
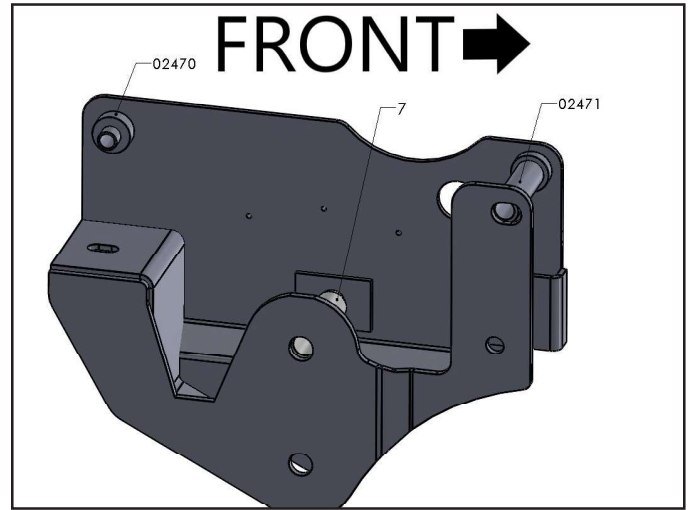

FIGURE 20



26. Grease and install bushing and sleeves into the upper and lower control arms. Thread the grease fitting into the arms. The 90 deg grease fitting is for the UCA.

27. With a jack still under the axle, disconnect the radius arm from the driver's side frame bracket. Install the new upper and lower control arm on the passenger's side. The upper arm will get 14mm" x 100mm hardware (Bolt Pack #352), the lower will get factory hardware at the frame (Fig. 18). Factory hardware is used at the axle for the upper control arm. Cam plates and new 18mm hardware (Bolt Pack #358) are provided for the lower control arm at the axle. The hole in the cam plate will be towards the rear of the vehicle. (Fig. 21) It is recommended to knock the nut tabs from the factory nuts to allow for quick torque of the hardware with the shocks in place later in the installation. Place a large socket over the nut and press off the tab in a vice.

Note: The lower and upper arms are curved inward towards the center of the vehicle for tire clearance.

FIGURE 21



28. Tighten all bracket hardware to the following; Factory radius arm bolt 258 ft-lbs, 5/8" hardware 180 ft-lbs, 1/2" hardware 90 ft-lbs. The arm hardware will be tightened later when the vehicle is on the ground.
29. Snug up but do not torque the lower control arm axle hardware to prevent the cam plates from falling out.

Note: The hole in the cam plate will be towards the rear of the vehicle. These plates are used to provide the proper amount of caster while not allowing the suspension to over extend the drive shaft at droop.

30. Repeat bracket and arm installation procedure on the driver's side.



Tip *Air assist only: The air tank could be remounted at this time following that part of the rear instructions. Do not start disassembling the rear. Finish the front first.*

31. Gas Models Only: Remount the vibration dampners to the frame using the provided 8mm hardware (Bolt Pack #357) and the provided 1-1/16" long spacers. Torque hardware to 15 ft-lbs. Replug in the 2 plugs to the dampner (Fig. 22).

FIGURE 22



BUMP STOP INSTALLATION:

32. Remove the factory bump stops, it is easiest to hit them from the side with a hammer to pop them out. (Fig. 23)

FIGURE 23



33. Grease the new replacement bump stops and raise the axle to press the bump stops into position. These will be a tight fit. It is easiest to lift the axle with a jack to compress the bump stops into position. (Fig. 24)

FIGURE 24



TRACK BAR BRACKET INSTALLATION

34. Remove the factory track bar bracket, retain the vertical hardware that goes into the cross member.
35. Install the provided trackbar bracket with factory bolts through the original vertical trackbar bracket holes in the crossmember, do not tighten.
36. Use the provided 14mm hardware in bolt pack 494, Bolt the new trackbar bracket to the Frame tab with the nut on the inside of the frame tab. Use OE hardware in the 3 remaining holes. Torque the OE bolts to 118 ft-lbs and provided 14mm hardware to 148.4 ft-lbs. (Fig 25)

FIGURE 25



37. Support the front axle and remove the factory shocks. Retain the lower hardware, discard shocks and upper hardware.
38. **6" Diesel & 4" Gas:** Lower the axle and install the new coils with factory isolator. The end of the spring with the windings closer together will go at the top, do not install upside down. The passenger's side upper mount will need to be reindexed. There is a template at the end of the instruction sheet. Cut this out and place over the passenger's side upper mount, mark the center of the hole, and drill to 1/2". The hole should now be directly to the 'Rear' of the vehicle. Install isolator with the new coil spring. Ensure that coils are seated properly, have someone help if necessary. (Fig 26a, 26b, 27a, 27b)

FIGURE 26A



FIGURE 26B



FIGURE 27A

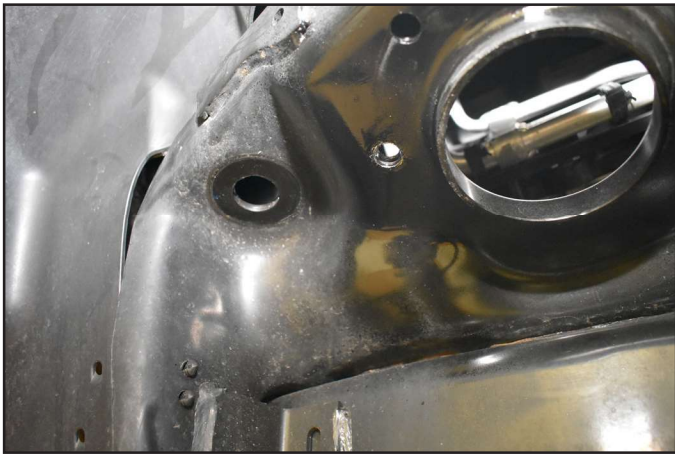
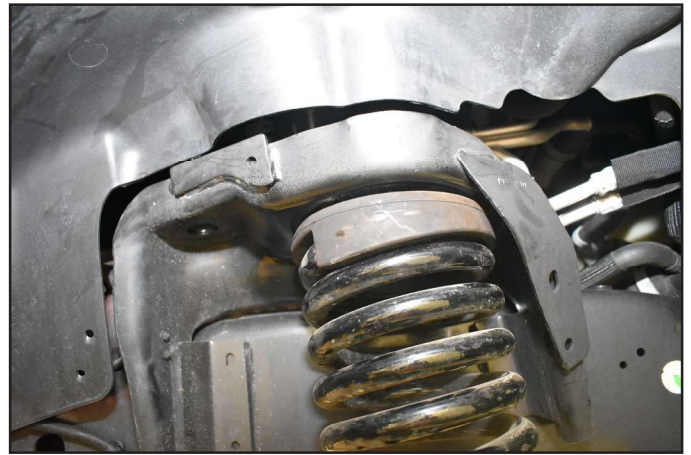

FIGURE 27B



39. **4" Diesel & 5.5" Gas:** Lower the axle and install the new coils with factory isolator. The end of the spring with the windings closer together will go at the top, do not install upside down. The passenger's side upper mount will need to be reindexed. There is a template at the end of the instruction sheet. Cut this out and place over the passenger's side upper mount, mark the center of the hole, and drill to 1/2". The hole should now be directly to the 'Outside' of the vehicle. Install isolator with new coil spring. Ensure that coils are seated properly, have someone help if necessary. (Fig 29a,28b, 29a, 29b)

FIGURE 28A



FIGURE 28B

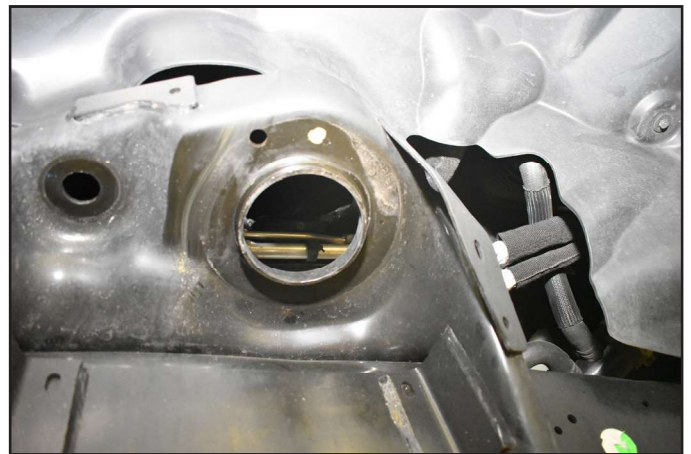
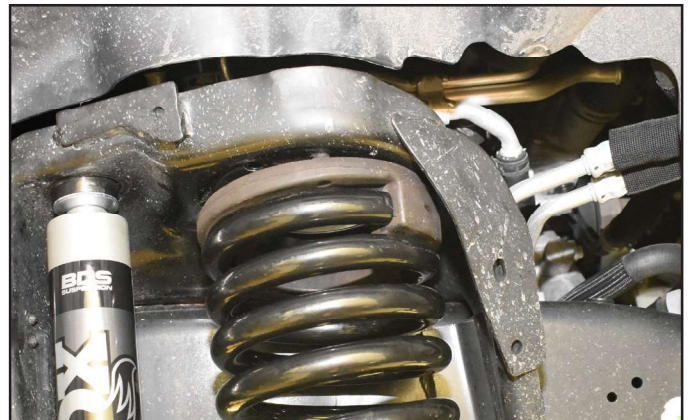

FIGURE 29A



FIGURE 29B



40. Grease and install the bushings and sleeves into the shocks. Install the new shocks with cup washers, bushings, and 1/2" nut at the top mount. Tighten the nut until the bushings begin to swell.
41. Attach the lower shock with factory hardware. Tighten hardware to 65 ft-lbs.

42. Mark or measure the amount of exposed threads on the drag link sleeve. Loosen the drag link sleeve until you can rotate the tie rod end 180deg. Re-thread the drag link sleeve to the original location. This is a starting point and will need to be adjusted after the installation is complete. (Fig 30, 31)

FIGURE 30

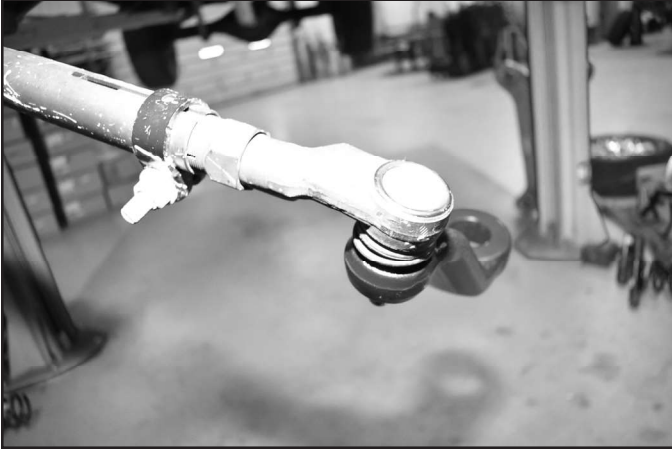

FIGURE 31



43. Install the new pitman arm, use the alignment mark made earlier. Thread locker the factory nut and install with lock washer tighten nut to 332 ft-lbs. (Fig 17)
44. Attach the drag link to pitman arm with a factory nut. Tighten to 27 ft-lbs Plus 180deg. (Fig 32)

FIGURE 32



45. Disconnect the brake line bracket from the frame (Fig. 31 Driver side). Reattach the factory brake line bracket to the axle with factory hardware, torque to 10ft-lbs. slightly bend the factory axle bracket to create more slack in the brake line with a pliers or small adjustable wrench.
46. Mount the brake line relocation bracket to the factory brake line mount location at the frame with factory hardware, torque to 9ft-lbs. Mount the brake line to the relocation bracket using the provided hardware (Bolt pack 495), torque to 101in-lbs. (Fig. 33 Driver Side shown, Fig. 34 Passenger side)

FIGURE 33



FIGURE 34



47. Install the sway bar drop between the mount and the frame with supplied 10mm hardware. Tighten hardware to 43 ft-lbs (Fig. 35)

FIGURE 35



Reconnect the sway bar links with the factory hardware, torque to 60ft-lbs

48. PLEASE SEE INDEX RING KIT INSTRUCTIONS AT THIS TIME.

49. PLEASE SEE REAR KIT INSTRUCTIONS AT THIS TIME.

50. Install wheels and tighten lug nuts to factory specifications. Lower the vehicle to the ground.
51. Tighten 4-link arm hardware to the following: 3/4" lower control arm frame hardware to 320 ft-lbs, 18mm lower control arm axle hardware to 270 ft-lbs. 14mm upper control arm hardware to 126 ft-lbs, factory upper control arm axle hardware to 258 ft-lbs.
52. If trackbar was disconnected from axle side for any reason, tighten trackbar axle hardware to 285 ft-lbs. Turn the steering wheel to get the trackbar sleeve to align with the hole in the bracket. Tighten to 74 ft-lbs plus 160deg.
53. The badge can now be riveted on to the 4-link brackets using the provided 1/8" rivets. Any residue on the badge can be cleaned up using alcohol or brake cleaner before install. With the badge not installed it can be painted to what ever color you desire, or left raw as a stainless steel badge.
54. Recheck all hardware, check again at 500 miles, and again at regularly scheduled maintenance intervals.
55. Straighten the wheels, adjust the steering wheel to center. Torque the drag link clamp bolt to 55 ft-lbs. Do not drive the vehicle with the wheel off center or adverse traction control events may occur.

POST-INSTALLATION

1. Recheck all hardware, check again at 500 miles, and again at regularly scheduled maintenance intervals. Check brake lines and ABS wires for proper clearance through steering sweep, use zip ties on the ABS wires if necessary.
2. These trucks can have a vibration from the factory under load and at extremely low RPM's (less than 1200 RPM's), the vibration can become more apparent after lifting the rear of the truck. There is an optional rear driveshaft spacer kit available (Part# 122007 - Non High Output). This will increase rear driveshaft spline engagement and has been found to reduce vibration in rare instances where a vibration is present.
3. Carrier bearing drop is available separately, and is not included in the kit. Order separately if required.

RIVET NUT INSTALLATION INSTRUCTIONS

RIVET NUT SIZING

1. Verify the correct size rivet nut for the application based on the thickness of material where the rivet nut is to be installed using the following chart.

Part Number	Thread Size	Body Length (in)	Material Thickness (in)		Drill Size (in)
			Min.	Max.	
95105A159	3/8-16	.690	.027	.150	17/32
95105A168	3/8-16	.805	.150	.312	17/32
95105A169	1/2-13	1.150	.063	.200	11/16
95105A170	1/2-13	1.300	.200	.350	11/16

HOLE PREPARATION

2. Drill hole to appropriate size for rivet nut installation. 1/2" Rivnuts require an 11/16" hole and 3/8" Rivnuts require a 17/32" drill. It is critical that this hole is drilled to the correct size. Remove any burrs that could keep the rivet nut from seating flat against either side of the hole surface.



Tip If the correct drill size is not available, it is possible to drill the hole to an available smaller size and slowly grind it out to until the rivet nut fits tight.

RIVET NUT INSTALLATION TOOL ASSEMBLY

3. For a 3/8" rivet nut, place the provided 3/8" SAE flat washer on the 3/8" x 1-1/2" bolt, followed by 7/16" hex nut and then a 3/8" serrated washer. (Fig. 1) Thread this tool assembly into the rivet nut.
4. For a 1/2" rivet nut, place the provided 1/2" SAE washer on a 1/2" x 2" bolt followed by a 9/16" high nut and 1/2" serrated edge lock washer. Thread this tool assembly into the rivet nut as shown. (Fig. 1)

FIGURE 1- 1/2" RIVET NUT SHOWN

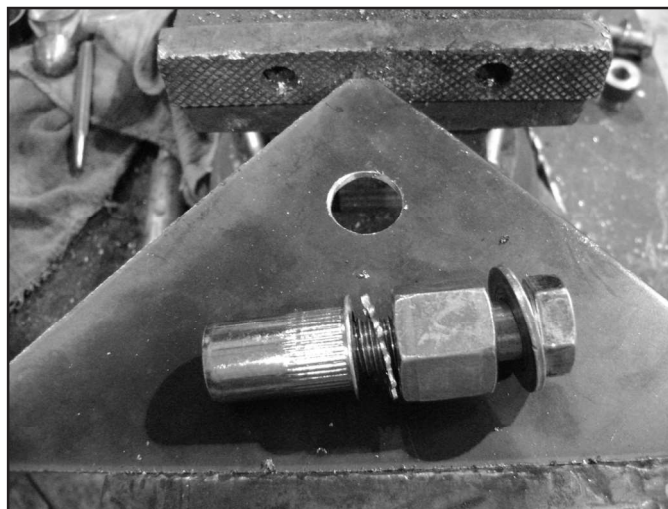

RIVET NUT INSTALLATION

5. Place the installation tool with the rivet nut threaded on the end into the appropriately sized hole.
6. For a 3/8" rivet nut, hold the nut closest to the rivet nut still with an 5/8" wrench and tighten the 3/8" bolt with a 9/16 wrench to set the rivet nut. Be sure to hold the rivet nut flush to the surface and square to the hole as it is tightened. (Fig. 2)



Tip *If available, an impact gun is recommended for tightening the bolt to ensure the rivet nut remains square to the hole and to ease holding the nut from spinning.*

7. For a 1/2" rivet nut, hold the nut closest to the rivet nut still with an 7/8" wrench and tighten the 1/2" bolt with a 3/4" wrench to set the rivet nut. Be sure to hold the rivet nut flush to the surface and square to the hole as it is tightened. (Fig. 2)

FIGURE 2 - 1/2" RIVET NUT SHOWN



TORQUE SPECIFICATIONS

8. 3/8" rivet nuts will approach 40 ft. lbs for maximum grip strength. Do not exceed 45 ft-lbs when setting the rivet nut.
9. 1/2" rivet nuts will approach 90 ft lbs for maximum grip strength. Do not exceed 100 ft-lbs when setting the rivet nut.



Tip *Note: If using the recommended impact gun, use caution to not exceed the recommended torque specifications.*

RIVET NUT TOOL REMOVAL

10. Once the center bolt is tightened, remain holding the nut from spinning with the wrench and loosen the center bolt to remove the installation tool.



Caution *It is very important to hold the nut as the bolt is loosened because the grip of the star washer will try to spin the rivet nut and ruin the installation.*

11. Verify proper installation by checking for consistent rivet nut deformation to see the threads are square and centered to the rivet nut. (Fig. 3)

FIGURE 3

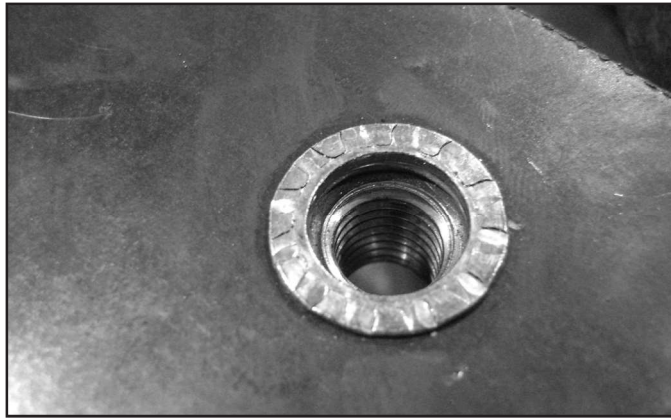

WE WANT TO SEE YOUR RIDE!

Grab photos of your BDS-equipped truck in action and send them in for a chance to be featured. Send it in to our Bad Ass Rides customer gallery at bds-suspension.com/bar and post them on the BDS Fan Page on Facebook at facebook.com/BDSSuspensions. Don't forget about your BDS swag! BDS offers t-shirts, hoodies, decals and more available on the BDS website or through your local BDS distributor.

TIME TO HAVE SOME FUN

Thank you for choosing BDS Suspension.

For questions, technical support and warranty issues relating to this BDS Suspension product, please contact your distributor/installer before contacting BDS Suspension directly.

