

ROUGH COUNTRY

SUSPENSION SYSTEMS®

FORD 2023-24 SUPERDUTY 6" LIFT KIT W/ RADIUS ARMS

Thank you for choosing Rough Country for your suspension needs.

Rough Country recommends a certified technician installs this system. In addition to these instructions, professional knowledge of disassemble/reassembly procedures as well as post installation checks must be known. Attempts to install this system without this knowledge and expertise may jeopardize the integrity and/or operating safety of the vehicle.

Please read all the instructions before beginning the installation. Check the kit hardware against the parts list. Be sure you have all the needed parts and understand where they go. Also please review the tools needed list and make sure you have needed tools.

PRODUCT USE INFORMATION

⚠ WARNING As a general rule, the taller a vehicle is the easier it will roll. We strongly recommend seat belts and shoulder harnesses should be worn at all times. Avoid situations where a side rollover may occur.

Braking performance and capabilities are decreased when significantly larger/heavier tires and wheels are used. Take this into consideration while driving. Also, speedometer recalibration is necessary when larger tires are installed.

Do not add, alter, or fabricate any factory or after-market parts which increase vehicle height over the intended height of the Rough Country product purchased. Mixing component brands, lifts, and/or combining body lift with suspension lifts voids all warranties. Rough Country makes no claims regarding lifting devices and excludes any and all implied claims. We will not be responsible for any product that is altered.

If you desire a different look or if the vehicle has a tool box or added weight in the rear, please consult with your sales representative about block / u-bolt options.

The 6" kit was developed for a 37x12.50x20 tire on an after market wheel w/ 4.5" back spacing.

⚠ NOTICE NOTICE TO DEALER AND VEHICLE OWNER

Any vehicle equipped with any Rough country product must have the "Warning to Driver" decal installed on the sun visor or dash. The decal is to act as a constant reminder for whoever is operating the vehicle of its unique handling characteristics. **INSTALLING DEALER**—It is your responsibility to install the warning decal and to forward these installation instructions on too the vehicle owner for review and to be kept in the vehicle for its service life.

Tools Needed:

10mm Socket / Wrench
 15mm Socket / Wrench
 18mm Socket / Wrench
 19mm Socket / Wrench
 21mm Socket / Wrench
 24mm Socket / Wrench
 30mm Socket
 34 Socket
 5/8" Socket / Wrench
 1 1/8" Wrench
 Jack Stands
 Jack
 Pliers
 Pitman Arm Tool
 Torque Wrench

Torque Specs:

Size	Grade 5	Grade 8
7/16"	45 ft/lbs	60 ft/lbs
1/2"	65 ft/lbs	90 ft/lbs
9/16"	95 ft/lbs	130 ft/lbs
5/8"	135 ft/lbs	175 ft/lbs
3/4"	185 ft/lbs	280 ft/lbs
	Class 8.8	Class 10.9
8MM	18ft/lbs	23 ft/lbs
10MM	32ft/lbs	45ft/lbs
12MM	55ft/lbs	75ft/lbs
14MM	85ft/lbs	120ft/lbs



KIT CONTENTS

9296

6" Diesel Coil Springs

41200991

1504BAG2
41200BAG1
Pitman Arm
Dr. Shim Plate
2 - Sway Bar Link
Stabilizer Frame Mount
Stabilizer Bar Mount
4 - Sway Bar Bracket
2 - Front Brake Line Bracket
Dr. Sway Bar Drop Bracket
Pass. Sway Bar Drop Bracket
Track Bar Bracket
Rear Brake Bracket
2 - Auto Leveling Headlight Sensor Bracket
2 - Body Puck

41200992

1481BAG1
5/8BAG
41930BAG1
4 - 19" U-bolt (Overload Option)
4 - 16" U-bolt (Non-Overload Option)
4 - Fabricated Block Shim
2 - Rear Lift Block

50420BOX1

2 - Front N3 Shocks
2 - Rear N3 Shocks

43701

43701BAG1
Dr. Radius Arm
Pass. Radius Arm



Bag Contents:

1504BAG1

5/16" Flange Locknut (4)
5/16" U-bolt (1)
1/2" Nylock Nut (1)
5/16" x 3/4" Bolts (2)
1/2" x 1.75" Bolt (1)
12mm Flange Locknut (1)
12mm x 55mm Bolt (1)
5/16" Flat Washers (2)
1/2" Flat Washer (1)
7/16" x 1.25" Bolts (4)
5/16" Lock Washers (8)
7/16" Nylock Nuts (4)

41200BAG1

10 - 7/16" Flat Washer
2 - 8mm x 95mm Bolt
1 - 7/16" x 1" Bolt
5 - 7/16" Lock Nut
4 - 7/16" x 1 1/4" Bolt
2 - #10 x 5/8" Button Head Bolt
2 - #10 Lock Nut

1481BAG1

4 - 3 1/4" Square U-bolt (Non-Overload Option)
4 - 4 1/4" Square U-bolt (Overload Option)
8 - 7/16" Flat Washer
8 - 7/16" Lock Nut

5/8BAG

8 - 5/8" Lock Nut
8 - 5/18" Flat Washer

41930BAG1

2 - Front Brake Line Bracket
2 - 5/16" x 3/4" Bolt
2 - 5/8" Flange Lock Nut

43701BAG1

4 - Radius Arm Cam Plate
2 - 18mm x 130mm Bolt
2 - 18mm Lock Nut



KIT PICTURE



FRONT INSTALLTION INSTRUCTIONS

1. Block the rear wheels of the vehicle. Raise the front of the vehicle and support the frame with jack stands. Remove the front wheels and tires and set aside. Position a hydraulic jack under the front axle and raise the jack until the front suspension begins to compress.
2. Disconnect the track bar from the driver side frame bracket, using a 30mm wrench. **See Photo 1.**
3. Remove the bump stop from the cup shaped bracket. Remove the bracket from the frame rail. **See Photo 2.**

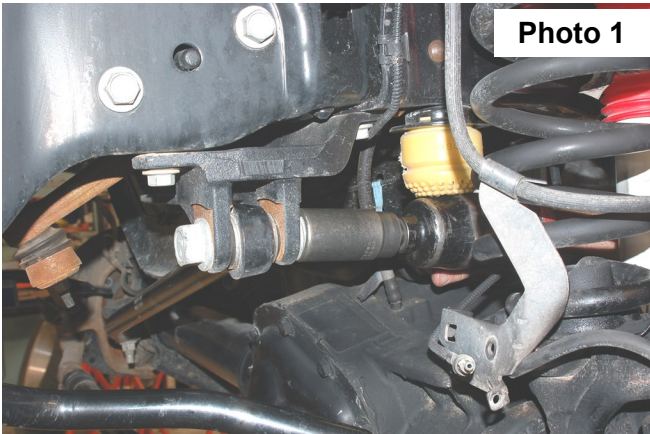

Photo 1

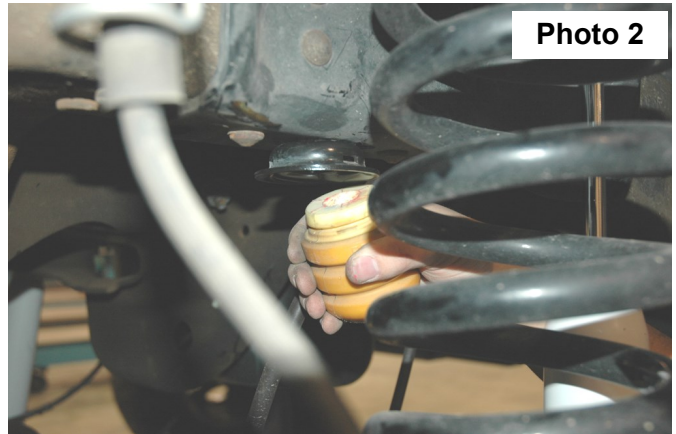

Photo 2

4. Using a 13mm socket, remove the brake line bracket from the frame. **See Photo 3.**
5. Remove the ABS wire from the brake line bracket. **See Photo 4.**

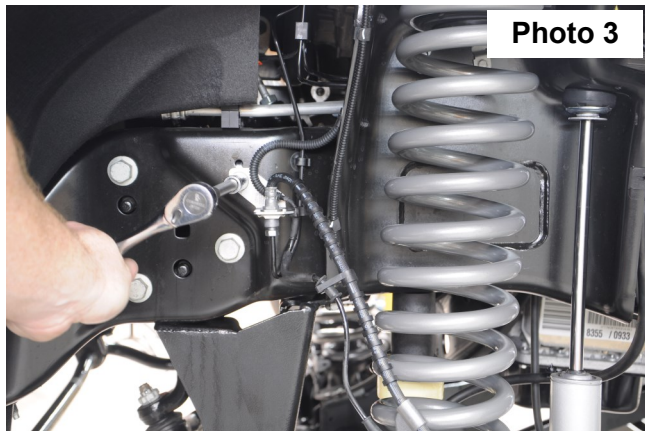

Photo 3

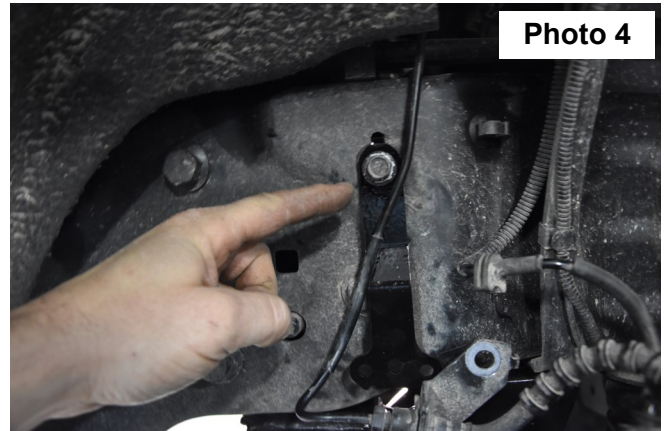

Photo 4

6. **DIESEL MODEL ONLY:** Carefully bend the brake line towards the coil. Install the new brake line bracket on the frame using the factory hardware. Torque to 15 ft-lbs. Attach the brake line to the extended bracket using the supplied 5/16 bolt, washer and nut. Torque to 15 ft-lbs. **See Photo 5.**
7. Repeat the process on the opposite side brake line. **See Photo 6.**



Photo 5

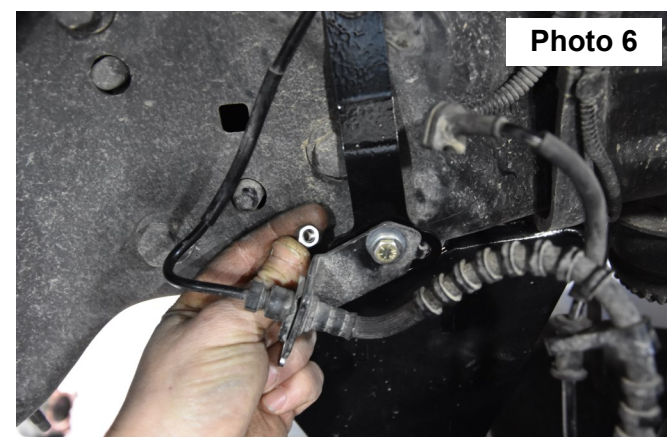
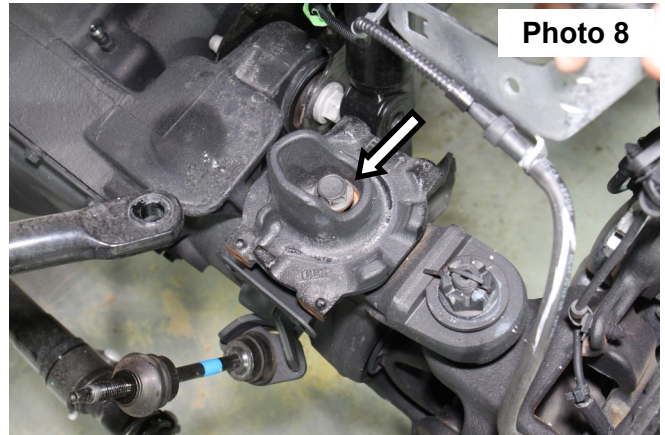
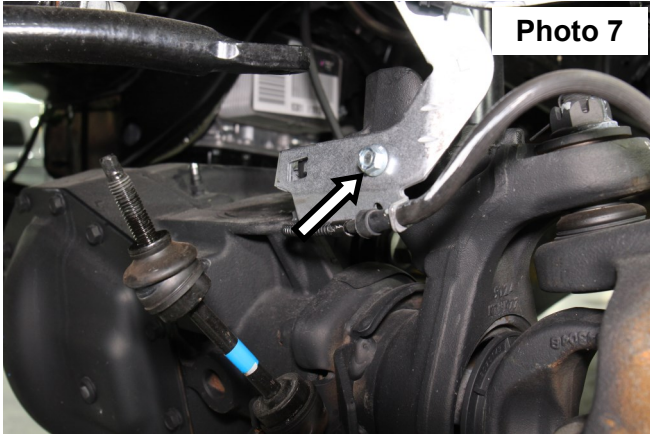

Photo 6

8. Using an 18mm wrench remove the sway bar links from the truck.
9. Using 18mm and 19mm wrenches, remove the front shocks.
10. Using 18mm and 15mm wrenches, remove the factory steering stabilizer from the truck.
11. Carefully lower the jack until the coil springs are free. Remove the coil springs from the vehicle. **Note:** Use of a coil spring compressor may be required for spring removal.

12. GAS MODELS ONLY: Remove the factory brake line bracket bolt with a 10mm wrench. **See Photo 7.**
13. GAS MODELS ONLY: Remove factory spring seat bolt using an 18mm socket. Retain hardware for reuse. **See Photo 8.**



14. GAS MODELS ONLY: Place supplied brake line bracket mount (41930BAG1) under the factory spring seat and around the factory spring seat bolt. **See Photo 9.**
15. GAS MODELS ONLY: Reinstall spring seat with supplied bracket in the mounting location using factory hardware. Tighten with an 18mm wrench. **See Photo 10.**

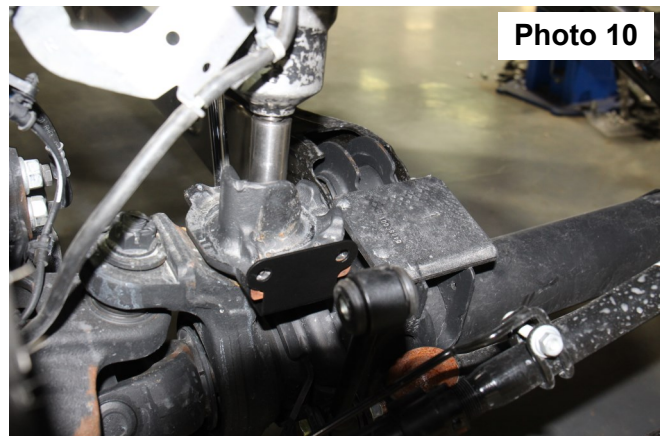

16. GAS MODELS ONLY: Reinstall factory brake line bracket to the previously installed mount using a supplied 5/16" x 3/4" bolt and 5/16" lock nut. Tighten with a 1/2" wrench. **See Photo 11.**

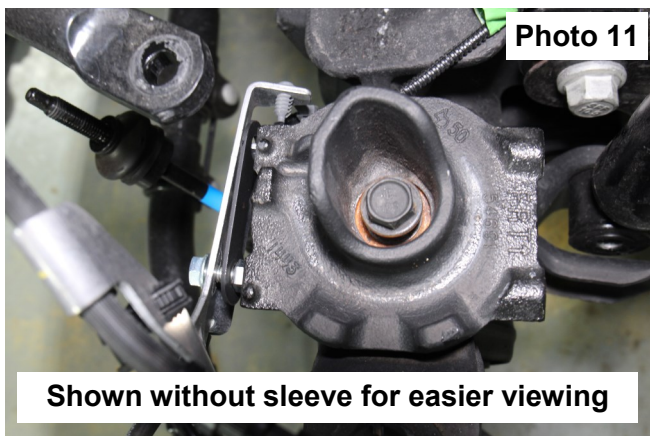

17. Remove upper radius arm bolt with a 24mm wrench and socket. Retain hardware for reuse. **See Photo 12.**

18. Remove the lower radius arm bolt using a 24mm wrench and socket. **See Photo 13.**

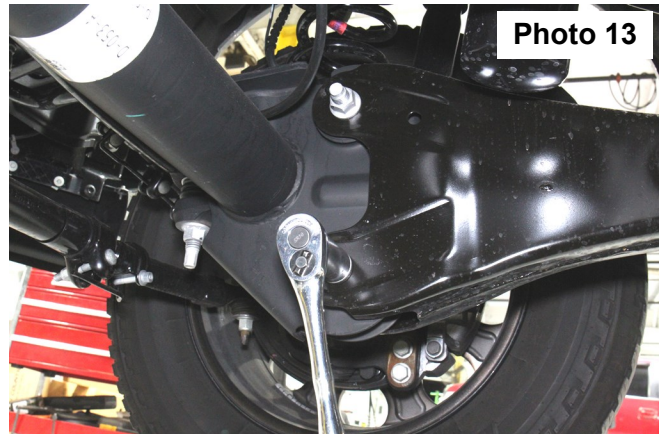
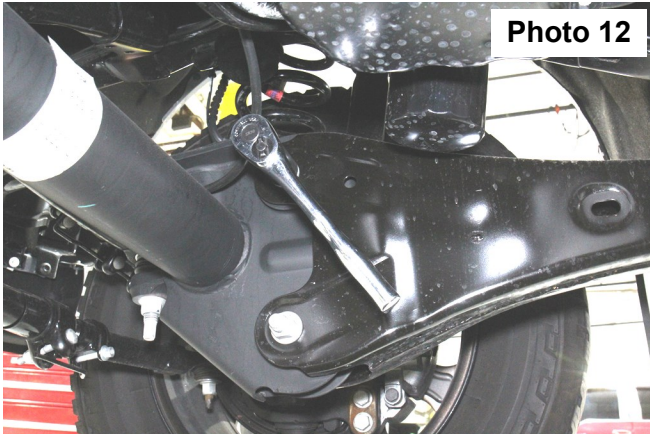

19. Remove rear radius arm bolt with a 24mm wrench and socket. Remove factory radius arm from vehicle. Retain hardware for reuse. **See Photo 14.**

20. Install supplied tubular radius arm at the rear using the factory hardware. Tighten with a 24mm wrench and socket. **See Photo 15.**

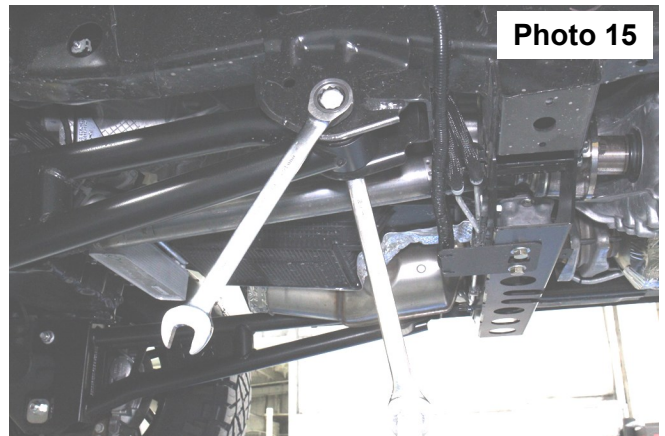
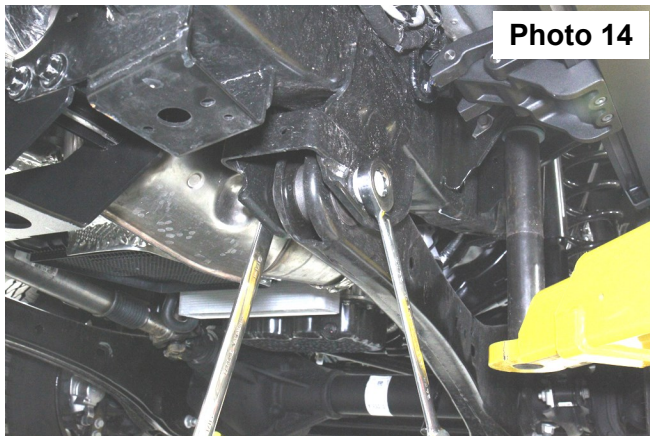

21. Use supplied 18mm x 130mm, (2) cam plates, and a supplied 18mm lock nut to secure the radius arm to axle in the lower bolt location. Tighten with a 24mm wrench and socket. **See Photo 16.**

22. Use the factory hardware to secure the radius arm to the upper bolt locations. **See Photo 17.**

23. Repeat for other side.

24. Using a 21mm wrench and 19mm socket remove the factory track bar bracket from the frame. Retain stock hardware for re-use.

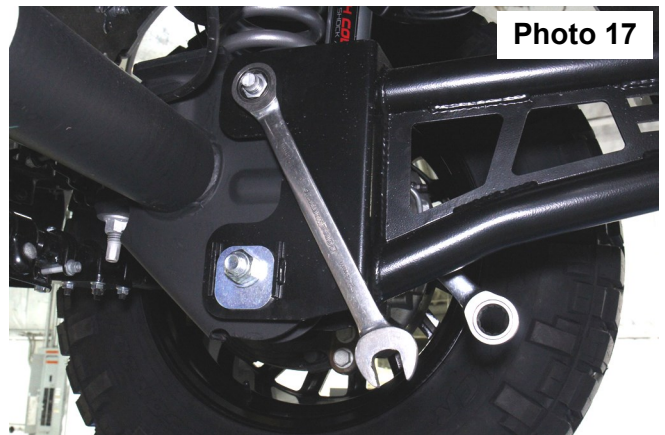
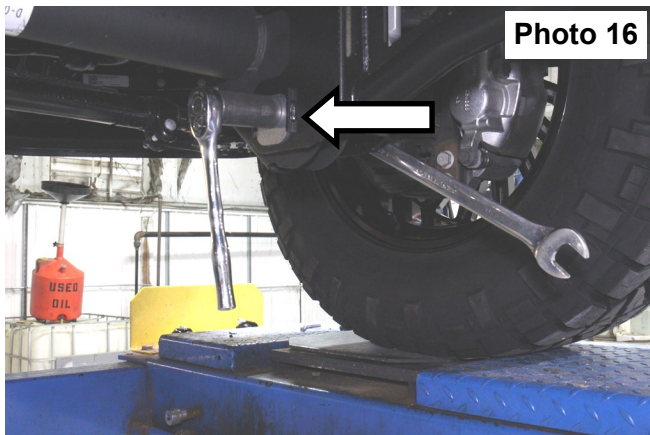

25. Using the nylon bump stop extension provided, place the extension between the frame and the bump stop cup. Bolt back into the original location using the 8mmx95mm bolt supplied. Torque to 15 ft-lbs. Reinstall the factory bump stop in the bump stop cup. **See Photo 18.**
26. Lower the front axle enough to install the new coil springs. Position the coil springs in the lower coil buckets on the axle and rotate as necessary to be sure that the pigtail of the coil is indexed properly in the bucket. Position the factory rubber isolator on top of each coil, then raise the axle enough to seat the coil springs in the upper spring buckets.
27. Compress the front springs enough to install the front shocks. Bolt the lower end of the shock to the axle using the stock hardware. Torque to 88 ft-lbs. using a 18mm wrench. Attach the upper end of the shock with the stock hardware, using a 19mm wrench. **Torque to 15 ft-lbs. Or only enough to bulge the bushing.**
28. Remove the cotter pin and nut using a 21mm wrench, from the drag link end where it attaches to the pitman arm.
29. Dislodge link with a tie rod end puller. **Note:** Replace the link if any stud looseness is detected, (excessive play) or (excessive wear) is found in the tie rod end.
30. Remove the collar lock bracket from the drag link on the truck using a 13mm wrench.
31. Using 15mm and 13mm wrenches, loosen the drag link adjustment collar. **See Photo 19.**

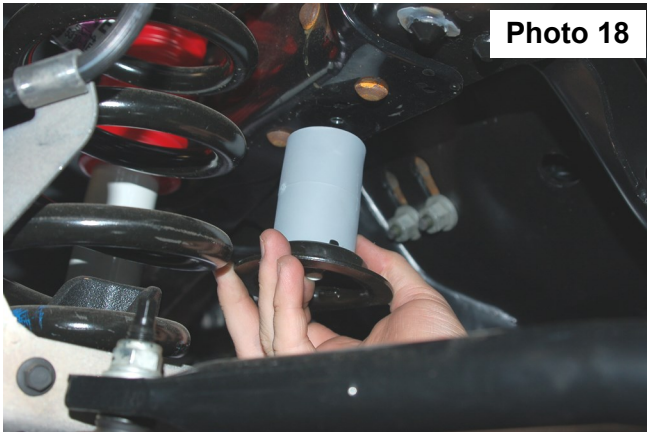

Photo 18

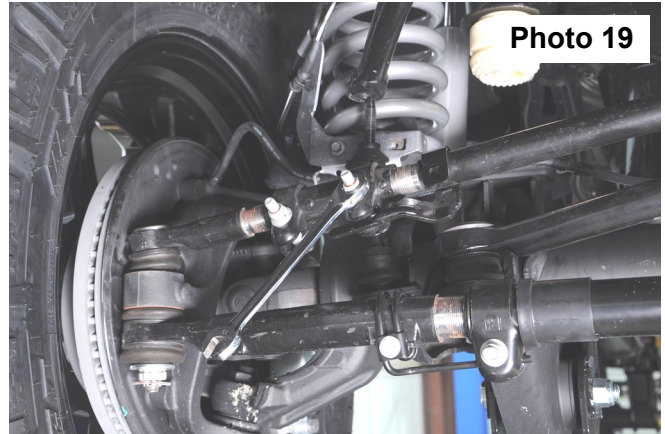

Photo 19

32. Spin the drag link over so the tie rod end is pointing up, torque the adjustment collar to 32 ft-lbs.
33. Using a 34mm socket, remove the nut from the steering sector and remove the pitman arm with a puller tool. Inspect the splines on the shaft for excessive wear, repair if needed.
34. Install new pitman arm, lock washer, and nut. Torque to 350 ft-lbs. Using a 34mm socket, tighten nut.
35. Attach the drag link stud to the pitman arm. Torque nut to 88 ft-lbs, and install cotter pin. Check for adequate linkage clearances while turning steering wheel full lock in both positions.
36. Position the Rough Country track bar bracket on the frame in the same position as the original and secure using the factory hardware. Torque to 120 ft-lbs. **See Photo 20.**
37. Using a 13mm socket, remove the stabilizer mount from the frame. **See Photos 21.**

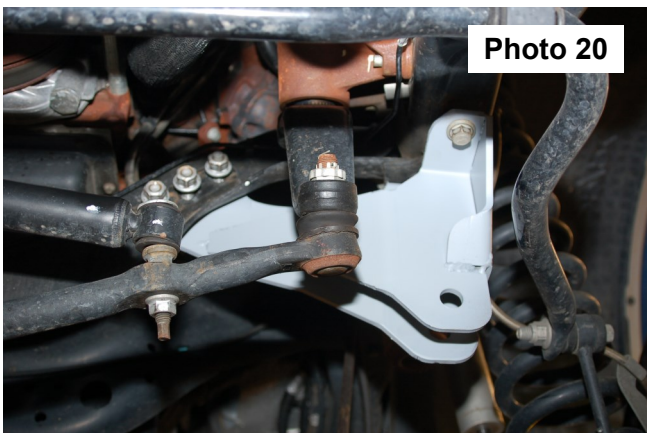

Photo 20

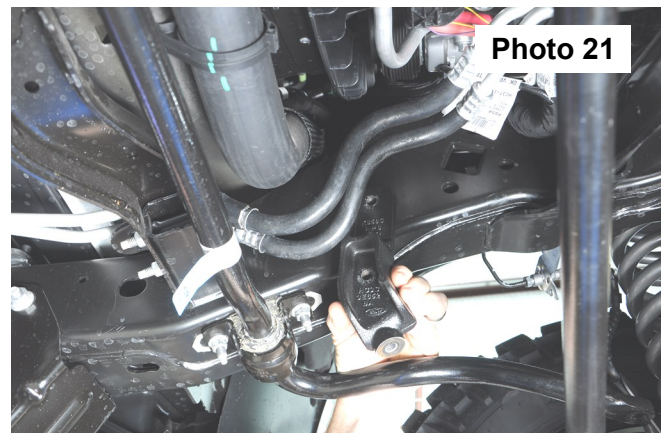
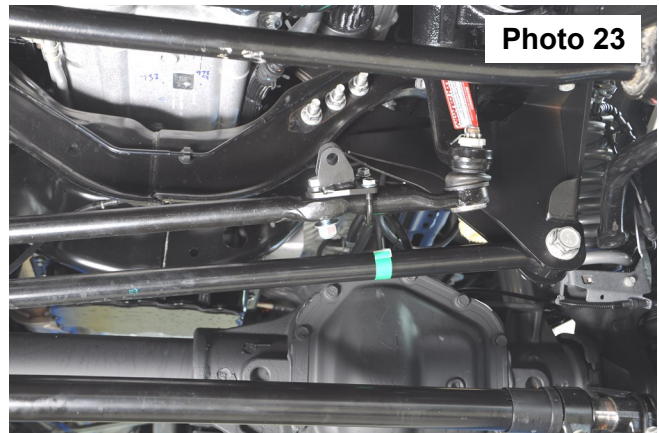
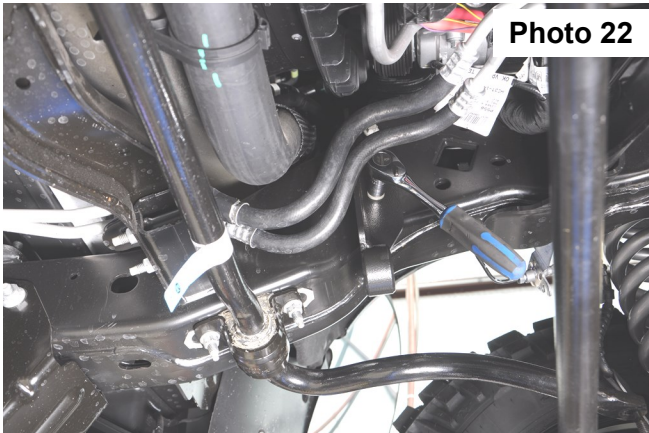
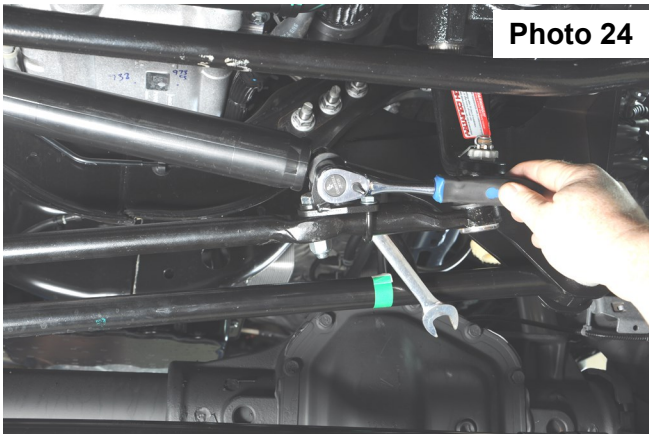

Photo 21

38. Install the new stabilizer bracket on the frame using the factory bolts, Torque to 45 ft-lbs. with a 13mm socket. **See Photo 22.**
39. Install the stabilizer bracket on the drag link using the supplied .5" x 2" bolt, washer and nut also using the supplied 5/16 u-bolt and nuts. **See Photo 23.** Torque the 1/2 inch bolt to 65 ft-lbs. Torque the 5/16 u-bolt to 15 ft-lbs.



40. Install the stabilizer on the frame mount using the factory hardware. Torque to 55 ft-lbs. using 18mm an socket. **See Photo 24.**
41. Using a 15mm socket, lower the factory sway bar from the frame. Retain the factory hardware.
42. Install the supplied sway brackets to the factory studs using the factory nut. **See Photo 25.** Torque to 32 ft-lbs using a 15mm socket.



43. Install the sway bar onto the brackets using the supplied 7/16" x 1.25" bolts, washers, and nuts. Tighten using a 5/8" socket and wrench. **See Photos 26 & 27.** Torque to 60 ft-lbs.

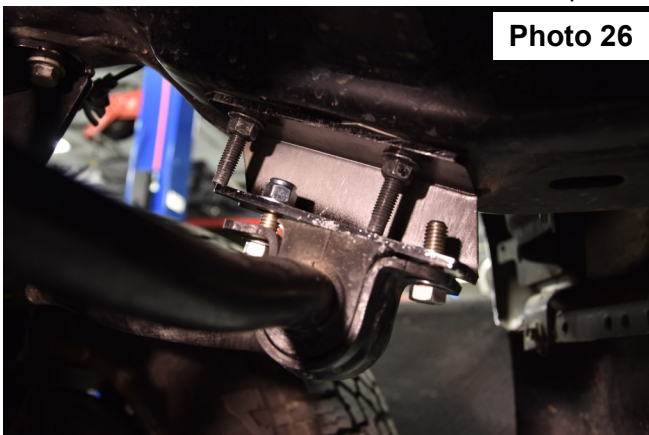

44. Install the supplied upper and lower sway bar link mounts using the supplied 1/2" x 1.5" bolts washers and nuts. Tighten using 3/4" wrenches. **See Photo 28.** Torque to 70 ft-lbs.
45. Install the sway bar links into the brackets using the supplied 12mm x 65mm bolts, washers, and nuts. Tighten using 18mm and 19mm wrenches. **See Photo 29.** Torque to 55 ft-lbs.

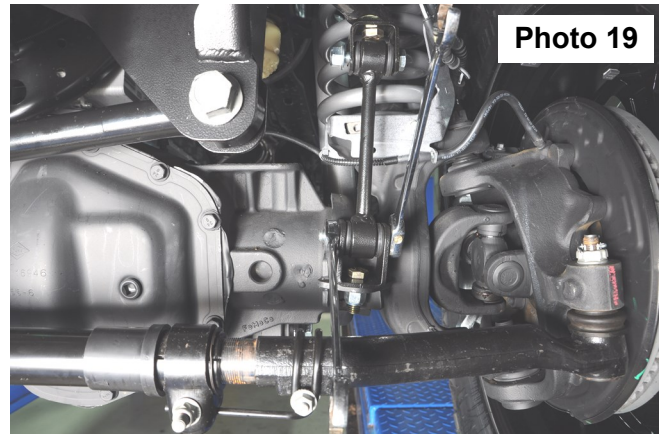
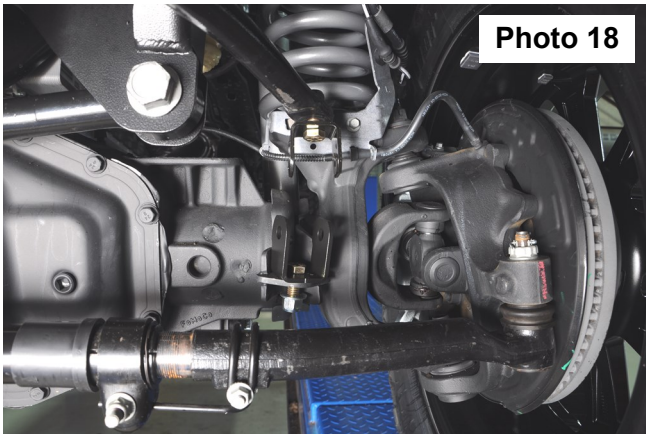

46. Install tires and wheels and lower the vehicle to the ground.
47. Line up the track bar with the hole in the new track bar bracket. You may have to start the truck and turn the wheels in the direction the track bar needs to go to help align the track bar with the hole. Install using the stock track bar bolt. Tighten bolt. Torque to 270 ft-lbs.
48. Torque the radius arm bolts to 270 ft-lbs.
49. Torque the radius arm brackets to 270 ft-lbs.

HEADLIGHT SENSOR BRACKET

1. Remove factory ride height sensor hardware with a 1/8" Allen wrench.
2. Attach the sensor bracket to the factory bracket using the supplied #10 hardware. Tighten with a 1/8" Allen wrench.
3. Re-use the factory ballstud to match the current lift kit on the vehicle. **See Photo 1.**

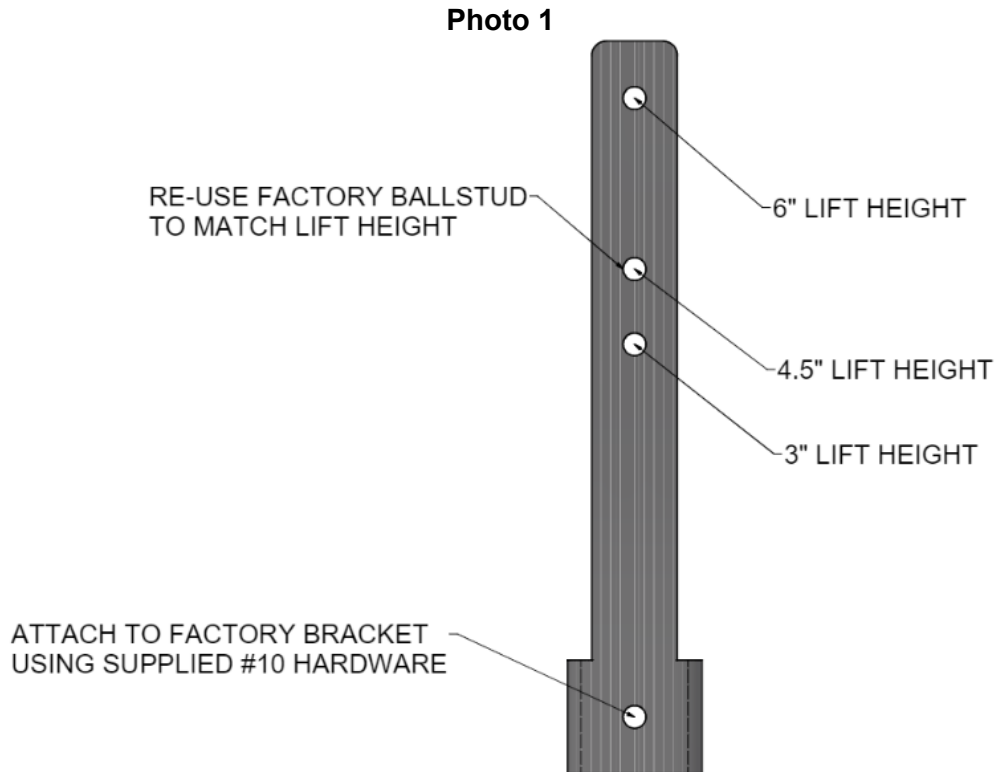

REAR INSTALLATION

1. Chock front wheels and jack up the rear of the vehicle. Secure with jack stands on the frame rail.
2. Place a floor jack under the rear differential on the rear axle. Using a 18mm wrench for the upper, and 19mm and 15mm wrench for the lower, remove the stock shock absorbers, retain the stock hardware for reuse.
3. Remove the diff vent hose from the differential. **See Photo 1.**
4. Remove the diff vent tube using a 5/8" wrench. Retain the vent tube for reuse. **See Photo 2.**

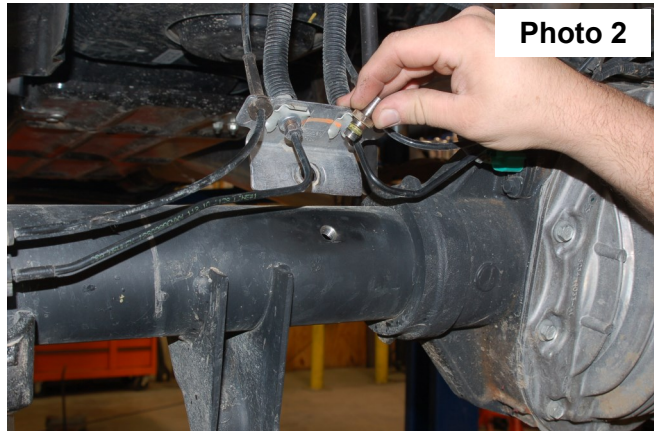

5. Install the supplied bracket in the stock location using the stock hardware. Torque to 28 ft-lbs. using a 5/8" socket. **See Photo 3.**
6. Install the stock brake line bracket to the new bracket with the supplied 7/16" x 1" Bolts, washers and lock nuts and Torque to 45 ft-lbs. using 5/8" wrench. Reinstall the diff vent hose as shown. **See Photo 4.**
7. Using a 24mm socket, remove the stock u-bolts. Use the floor jack to lower the axle assembly to allow for lifted block installation.



8. Place the rear lift block under the leaf pack. Replace the factory U-bolts with the supplied 5/8" round U-bolts in the factory location using the supplied U-bolt hardware from 5/8BAG. Install supplied 7/16" square U-bolts over the bottom section of the leaf spring and through the holes in the lift block using the supplied 7/16" hardware. Tighten with a 15/16" wrench and 5/8" wrench. **See Photo 5.**
9. Reinstall rear wheels and lower vehicle to the ground.

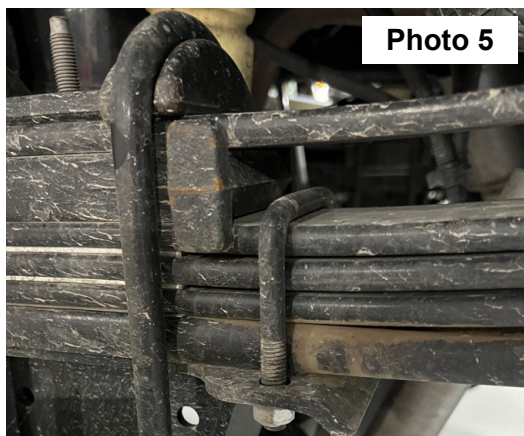

POST INSTALLTION INSTRUCTIONS

1. Adjust steering wheel to re-center prior to driving.
2. Check all fasteners for proper torque. Check to ensure for adequate clearance between all rotating, mobile, fixed, and heated members. Verify clearance between exhaust and brake lines, fuel lines, fuel tank, floor boards and wiring harness. Check steering gear for clearance. Test and inspect brake system.
3. Perform steering sweep to ensure front brake hoses have adequate slack and do not contact any rotating, mobile or heated members. Inspect rear brake hoses at full extension for adequate slack. Failure to perform hose check/ replacement may result in component failure. Longer replacement hoses, if needed can be purchased from a local parts supplier.
4. Have a qualified alignment center realign front end to
 - Caster min- 4.0 degree
 - Camber -0.6—.09 degree
 - Toe -.10- .15 degree
5. Install Warning to Driver decal on sun visor.
6. Re-torque all nuts, bolts, and especially u-bolts after the first 100 miles, again after another 100 miles and then check periodically thereafter.
7. All components must be retightened after 500 miles, and every three thousand miles after installation
8. Adjust headlights to proper settings.



Thank you for choosing Rough Country for your suspension needs.

By purchasing any item sold by Rough Country, LLC, the buyer expressly warrants that he/she is in compliance with all applicable Federal, State, and Local laws and regulations regarding the purchase, ownership, and use of the item. It shall be the buyers responsibility to comply with all Federal, State and Local laws governing the sales of any items listed, illustrated or sold. The buyer expressly agrees to indemnify and hold harmless Rough Country, LLC for all claims resulting directly or indirectly from the purchase, ownership, or use of the items.

