

# INSTALLATION GUIDE



Part#: 012312



**HARDCORE LIMITED LIFETIME WARRANTY**

**3" Suspension System**

Dodge Ram 3500 | 2013-2022

Dodge Ram 2500 | 2014-2023

**2" Suspension System**

RAM POWER WAGON | 2019-2021

Rev. 080323

491 W. Garfield Ave., Coldwater, MI 49036 • Phone: 517-279-2135

E-mail: [tech-bds@ridefox.com](mailto:tech-bds@ridefox.com)

# Read And Understand All Instructions And Warnings Prior To Installation Of System And Operation Of Vehicle.

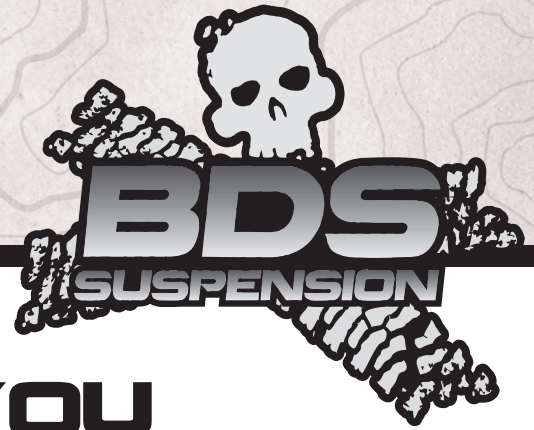

## THANK YOU

Your truck is about to be fitted with the best suspension system on the market today. That means you will be driving the baddest looking truck in the neighborhood, and you'll have the warranty to ensure that it stays that way for years to come.

Thank you for choosing BDS Suspension!

### BEFORE YOU START

BDS Suspension Co. recommends this system be installed by a professional technician. In addition to these instructions, professional knowledge of disassembly/ reassembly procedures and post installation checks must be known.

### FOR YOUR SAFETY

Certain BDS Suspension products are intended to improve off-road performance. Modifying your vehicle for off-road use may result in the vehicle handling differently than a factory equipped vehicle. Extreme care must be used to prevent loss of control or vehicle rollover. Failure to drive your modified vehicle safely may result in serious injury or death. BDS Suspension Co. does not recommend the combined use of suspension lifts, body lifts, or other lifting devices. You should never operate your modified vehicle under the influence of alcohol or drugs. Always drive your modified vehicle at reduced speeds to ensure your ability to control your vehicle under all driving conditions. Always wear your seat belt.

### BEFORE INSTALLATION

- Special literature required: OE Service Manual for model/year of vehicle. Refer to manual for proper disassembly/reassembly procedures of OE and related components.
- Adhere to recommendations when replacement fasteners, retainers and keepers are called out in the OE manual.
- Larger rim and tire combinations may increase leverage on suspension, steering, and related components. When selecting combinations larger than OE, consider the additional stress you could be inducing on the OE and related components.
- Post suspension system vehicles may experience drive line vibrations. Angles may require tuning, slider on shaft may require replacement, shafts may need to be lengthened or trued, and U-joints may need to be replaced.
- Secure and properly block vehicle prior to installation of BDS Suspension components. Always wear safety glasses when using power tools.
- If installation is to be performed without a hoist, BDS Suspension Co. recommends rear alterations first.
- Due to payload options and initial ride height variances, the amount of lift is a base figure. Final ride height dimensions may vary in accordance to original vehicle attitude. Always measure the attitude prior to beginning installation.



Visit [560plus.com](http://560plus.com) for more information.

### TIRES AND WHEELS

35x12.50x17 / 18 / 20  
9" Wide Wheel With 4-1/2" ~ 5" Backspacing



### BEFORE YOU DRIVE

Check all fasteners for proper torque. Check to ensure for adequate clearance between all rotating, mobile, fixed, and heated members. Verify clearance between exhaust and brake lines, fuel lines, fuel tank, floor boards and wiring harness. Check steering gear for clearance. Test and inspect brake system.

Perform steering sweep to ensure front brake hoses have adequate slack and do not contact any rotating, mobile or heated members. Inspect rear brake hoses at full extension for adequate slack. Failure to perform hose check/ replacement may result in component failure. Longer replacement hoses, if needed can be purchased from a local parts supplier.

Perform head light check and adjustment.

Re-torque all fasteners after 500 miles. Always inspect fasteners and components during routine servicing.

# CONTENTS OF YOUR KIT

BDS012312 Main Box Kit		
Part #	Qty	Description
03855	1	Brake Line Bracket - Drv
03856	1	Brake Line Bracket - Pass
02378BK	2	Bump Stops
A350	1	Adjustable Track Bar
B56X114G8	4	5/16" x 1-1/4" SHCS
3565BK	4	Dodge T-bar Bushings
143	2	2013 Dodge T-bar Sleeve
342701	1	Thread Locker
A239	(2)	Sway Bar Link Assembly
03012	2	Clevis
03029	2	Sleeve - Upper
149	2	Sleeve - Lower
M03212-BK-01	2	Offset Spacer
677	1	Bolt Pack
495	1	Bolt Pack - Brake Line Bracket

BDS122321 Radius Arm Box Kit (DSL 3" only)		
Part #	Qty	Description
A243	2	Radius Arm Assembly
02802	2	Aluminum Logo Plate - In DRV Position
995	1	Bolt Pack
	4	Rivet

\*Rear Box kits - See Separate Instruction Sheets\*

# INSTALLATION INSTRUCTIONS

## INSTALLATION INSTRUCTIONS

1. Park vehicle on clean, flat, and level surface. Block the rear wheels for safety.
2. Disconnect the front trackbar bolt from the frame while the vehicle is still on the ground. Retain bolt and nut tab. (Fig 1)

## SPECIAL TOOLS

1-1/16" or 27mm Socket

**FIGURE 1**

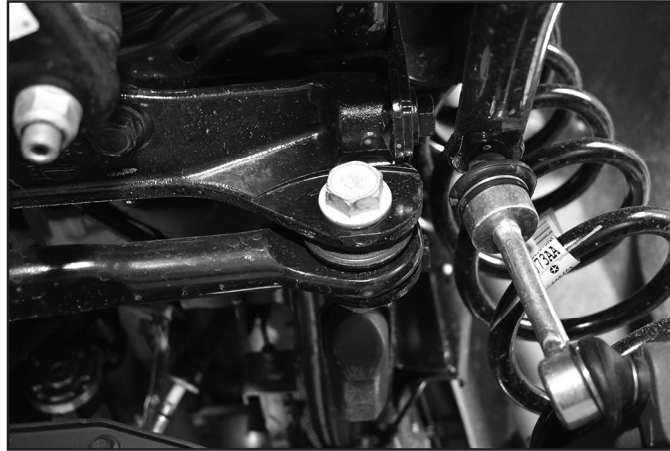

3. Raise the front of the vehicle and support the frame rails with jackstands. Note: The radius arms will be removed during this installation; do not support the weight of the truck on the radius arms.
4. Remove the wheels.
5. Disconnect the front driveshaft from the front axle. Hang the drive shaft from the frame. Retain all hardware.
6. Remove the trackbar bolt from the axle, retain bolt and nut tab. (Fig 2)

**FIGURE 2**



7. Remove the factory sway bar links, they will not be reinstated. (Fig 3)

**FIGURE 3**



8. Disconnect the brake line bracket from the top of the axle. Retain hardware (Fig 4)

**FIGURE 4**



9. Disconnect the brake line from the backside of the axle. Retain hardware (Fig 5)

**FIGURE 5**



10. It is recommended to disconnect the drag link from the pitman arm at this time. This will prevent the joint from binding while installing new coils. Use care not to damage the drag link joint boot. (Fig 6)

**FIGURE 6**



11. Detach the ABS and Central Axle Disconnect wires from retaining clips to allow for extra slack when new coils will be installed.
12. Support the front axle with a hydraulic jack.
13. Disconnect the shock hardware at lower and upper mounts; keep the lower bolt and nut tab. Remove the shocks. (Fig 7)

**FIGURE 7**



14. Lower the axle and remove the factory coils. Use care not to overextend any brake line, ABS, or CAD wires.

### **RADIUS ARM INSTALLATION: (DSL 3" ONLY, POWER WAGON 2" SKIP TO STEP 18)**

15. Working on one side of the vehicle at a time, remove the factory radius arm. Retain all hardware.
16. Replace the radius arm with the new one, both sides are the same. Reattach with factory hardware. Adjust the cams so the bolt is centered. (Fig 8a Driver Side shown) Note: Due to increased caster built into the arms, it may not be possible to reinstall the factory hardware with the opposite side hardware in. Remove one of the opposing bolts at the axle to allow the axle to rotate. (Fig 8b)

**FIGURE 8A**



**FIGURE 8B**

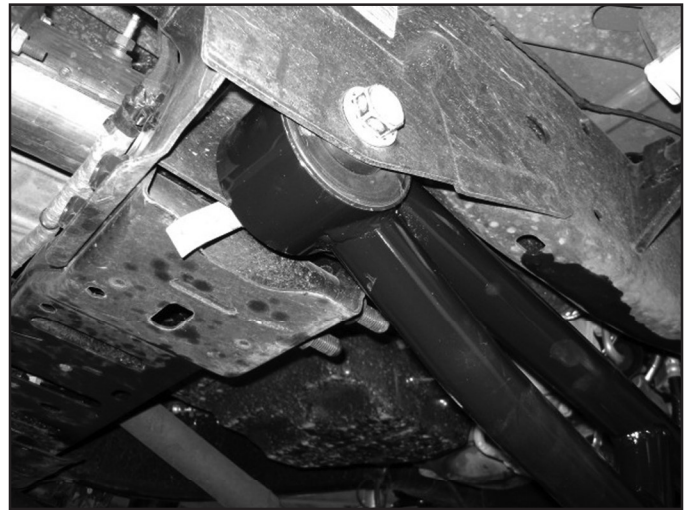

17. Repeat radius arm installation on opposite side.
18. Tighten the upper bolt at the axle to 258 ft-lbs. Tighten lower cams to 258 ft-lbs. Do not tighten the pivot bushing hardware at the frame at this time.

### **BUMP STOP INSTALLATION:**

19. Remove the factory bump stops. It is easiest to hit them from the side with a hammer to get them to pop out. (Fig 9a)
20. Lightly grease and install new bump stops by compressing the axle and pressing the bump stops into position. (Fig 9b)

**FIGURE 9A**



**FIGURE 9B**



### **COIL / SHOCK INSTALLATION:**

21. See Instruction provided in Coil Spring box for proper indexing of the Passenger side coil spring.
22. Install new coils with the factory isolator on top of the coil. The end of the spring with the windings closer together will go at the top, do not install upside down. Use hydraulic jack to raise the axle to seat the coils. Ensure that the coils are seated properly. Driver's side – Figure 10

**FIGURE 10 - DRIVER'S SIDE**

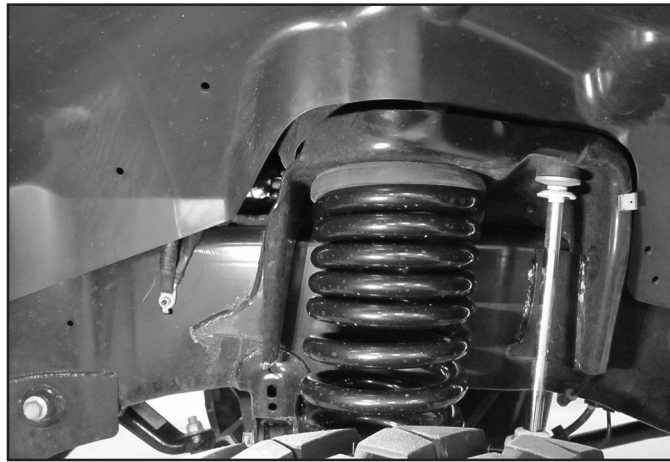

23. Grease and install bushings into new shocks. Install new shocks on vehicle with factory lower hardware and new cup washers, bushings, and nut on the top. Tighten the upper nut until the bushings begin to swell, do not over tighten. Note: It is easiest to install the lower hardware first, compress the shock and allow it to expand up into the upper mounting position. Ensure that the upper mount is centered in the factory hole. Tighten lower mount to 89 ft-lbs.)



**Tip** Front shock numbers for 2019+ are Fox982244710 or 85713.

*Front shock numbers for 2013/14-2018 are Fox98224700 or 85700*

24. Lower the axle and allow the axle to hang from the shocks.

## **TRACKBAR INSTALLATION:**

25. Grease and install bushings and sleeves into the trackbar assembly. Adjust length to 39-1/8".
26. Remove the bolts on the adjusting collar, apply thread locker to threads, and reinstall into adjusting collar.
27. First, tighten pinch bolts on track bar left-to-right at 30 ft-lbs.
28. Repeat left-to-right torque sequence at 30 ft-lbs until all pinch bolts meet 30 ft-lbs specification.
29. Install into the vehicle by attaching the axle end first with factory bolt and nut tab. Do not tighten at this time; do not attach the frame mount at this time.
30. Reattach the factory drag link to the pitman arm with factory nut. Tighten to 65 ft-lbs.

## **BRAKE LINE BRACKET:**

31. Unbolt the Brake lines from the frame. Retain hardware. Install the provided brake line relocation brackets onto the frame, driver and passenger side. Attach the brake line to the relocation bracket. Some manipulation of the hard line will be required. Ensure the tab on the factory line is located in the relocation bracket. Brake line relocation hardware in BP495. Tighten factory hardware to 15 ft-lbs, tighten provide hardware to 209 in-lbs. (Fig 11)

**FIGURE 11**

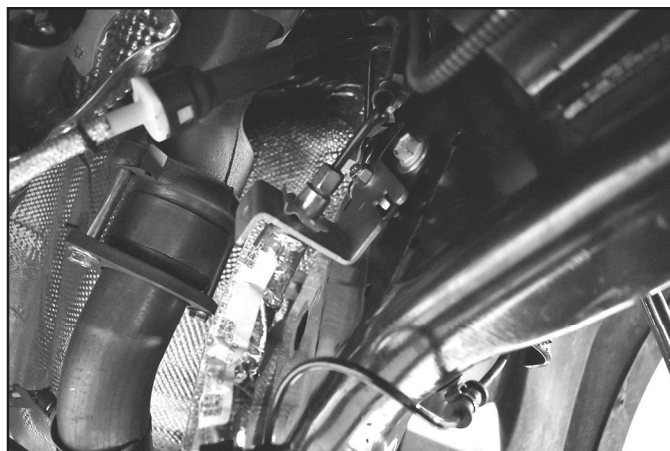



32. Reattach the brake line to the axle with factory bolts and locations, tighten to 15 ft-lbs.

## SWAY BAR LINKS:

33. Install new sway bar links. The clevis bracket will be a tight squeeze to get over the factory sway bar (keeps it from rotating). It may be necessary to slightly clear the widest part of the sway bar to get the bracket to fit over it. Attach with hardware as shown. (Fig 12a, 12b, 12c, & 12d). Torque upper 10mm button bolts to 30 ft-lbs, lower bolt to 88 ft-lbs.

**FIGURE 12A**

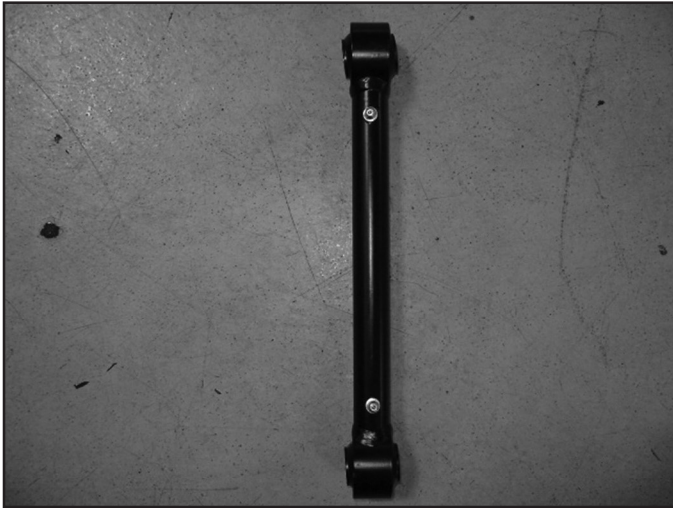

**FIGURE 12B**



**FIGURE 12C**

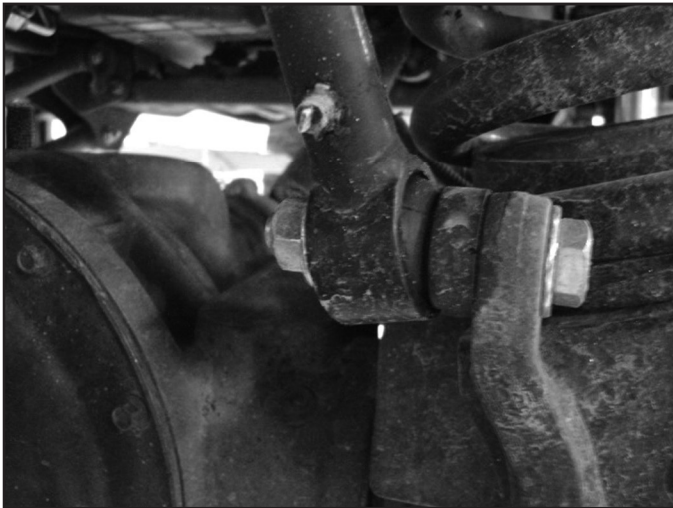

**FIGURE 12D**

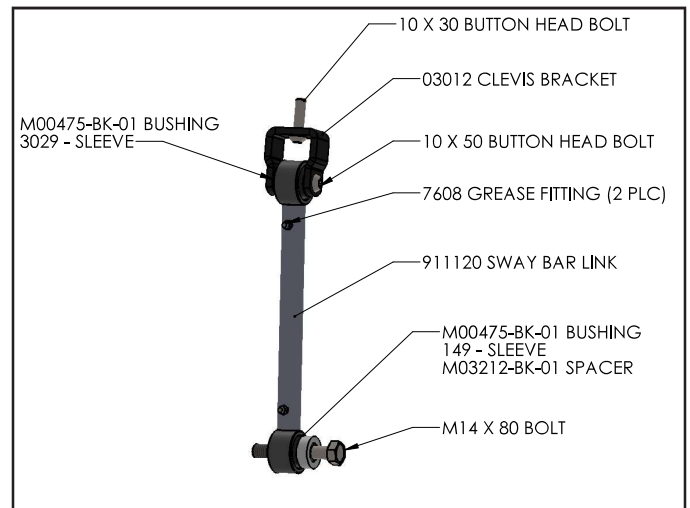

## REAR KIT (2500, 3500, & POWER WAGON SEE SEPARATE INSTRUCTION SHEET):

34. Reattach the front drive shaft to the axle with OE hardware and thread locker, torque to 85 ft-lbs. rotate the front drive shaft to ensure it spins freely and clears exhaust and crossmember. It may be necessary to move the wiring harness rearward on crossmember. To do this carefully remove the push-in ziptie and move to the hole located further rear on the crossmember.
35. Reinstall wheels, torque to specification. Lower vehicle to the ground and torque u-bolts to 120 ft-lbs.
36. Reinstall wheels, lower vehicle to the ground and torque lug nuts to specification.
37. Tighten the radius arm mount at the frame to 258 ft-lbs.
38. If trackbar was disconnected from axle side for any reason, tighten trackbar axle hardware to 285 ft-lbs Turn the steering wheel to get the trackbar sleeve to align with the hole in the frame bracket. Attach with factory bolt and nut tab. Tighten to 74 ft-lbs plus 160deg.
39. Straighten the steering wheel by adjusting the drag link adjuster. Do not drive the vehicle for extended periods of time with the steering wheel off center.
40. Recheck all hardware for proper torque, check again after 500 miles, and at regularly scheduled maintenance intervals.
41. An alignment is now recommended. The caster should fall between 4.00 and 5.50 (between 5.00 and 5.50 is recommended), adjustment for better driving characteristics may be required.



## **WE WANT TO SEE YOUR RIDE!**

Grab photos of your BDS-equipped truck in action and send them in for a chance to be featured. Send it in to our Bad Ass Rides customer gallery at [bds-suspension.com/bar](http://bds-suspension.com/bar) and post them on the BDS Fan Page on Facebook at [facebook.com/BDSSuspensions](https://facebook.com/BDSSuspensions). Don't forget about your BDS swag! BDS offers t-shirts, hoodies, decals and more available on the BDS website or through your local BDS distributor.

---

## **TIME TO HAVE SOME FUN**

### **Thank you for choosing BDS Suspension.**

For questions, technical support and warranty issues relating to this BDS Suspension product, please contact your distributor/installer before contacting BDS Suspension directly.

