

# INSTALLATION GUIDE



Part#: 012627



**HARDCORE LIMITED LIFETIME WARRANTY**

## 8" Rear Suspension System

**Dodge Ram 2500 | 2019-2023**

Rev. 042023

491 W. Garfield Ave., Coldwater, MI 49036 • Phone: 517-279-2135

Web: [www.bds-suspension.com](http://www.bds-suspension.com) • E-mail: [tech-bds@ridefox.com](mailto:tech-bds@ridefox.com)



# Read And Understand All Instructions And Warnings Prior To Installation Of System And Operation Of Vehicle.

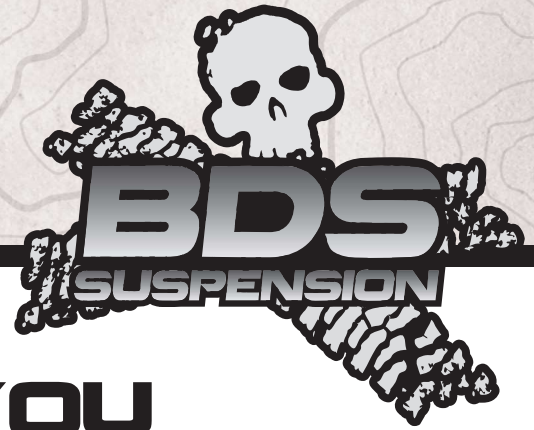

## THANK YOU

Your truck is about to be fitted with the best suspension system on the market today. That means you will be driving the baddest looking truck in the neighborhood, and you'll have the warranty to ensure that it stays that way for years to come.

Thank you for choosing BDS Suspension!

### BEFORE YOU START

BDS Suspension Co. recommends this system be installed by a professional technician. In addition to these instructions, professional knowledge of disassembly/ reassembly procedures and post installation checks must be known.

### FOR YOUR SAFETY

Certain BDS Suspension products are intended to improve off-road performance. Modifying your vehicle for off-road use may result in the vehicle handling differently than a factory equipped vehicle. Extreme care must be used to prevent loss of control or vehicle rollover. Failure to drive your modified vehicle safely may result in serious injury or death. BDS Suspension Co. does not recommend the combined use of suspension lifts, body lifts, or other lifting devices. You should never operate your modified vehicle under the influence of alcohol or drugs. Always drive your modified vehicle at reduced speeds to ensure your ability to control your vehicle under all driving conditions. Always wear your seat belt.

### BEFORE INSTALLATION

- Special literature required: OE Service Manual for model/year of vehicle. Refer to manual for proper disassembly/reassembly procedures of OE and related components.
- Adhere to recommendations when replacement fasteners, retainers and keepers are called out in the OE manual.
- Larger rim and tire combinations may increase leverage on suspension, steering, and related components. When selecting combinations larger than OE, consider the additional stress you could be inducing on the OE and related components.
- Post suspension system vehicles may experience drive line vibrations. Angles may require tuning, slider on shaft may require replacement, shafts may need to be lengthened or trued, and U-joints may need to be replaced.
- Secure and properly block vehicle prior to installation of BDS Suspension components. Always wear safety glasses when using power tools.
- If installation is to be performed without a hoist, BDS Suspension Co. recommends rear alterations first.
- Due to payload options and initial ride height variances, the amount of lift is a base figure. Final ride height dimensions may vary in accordance to original vehicle attitude. Always measure the attitude prior to beginning installation.



Visit [560plus.com](http://560plus.com) for more information.

### TIRES AND WHEELS

40x13.50 w/ 4.5" to 5.5" Backspacing on 9" wide wheel.

38x15.50 w/ 5.5" Backspacing on 12" wide wheel.



### BEFORE YOU DRIVE

Check all fasteners for proper torque. Check to ensure for adequate clearance between all rotating, mobile, fixed, and heated members. Verify clearance between exhaust and brake lines, fuel lines, fuel tank, floor boards and wiring harness. Check steering gear for clearance. Test and inspect brake system.

Perform steering sweep to ensure front brake hoses have adequate slack and do not contact any rotating, mobile or heated members. Inspect rear brake hoses at full extension for adequate slack. Failure to perform hose check/ replacement may result in component failure. Longer replacement hoses, if needed can be purchased from a local parts supplier.

Perform head light check and adjustment.

Re-torque all fasteners after 500 miles. Always inspect fasteners and components during routine servicing.

# CONTENTS OF YOUR KIT

012627 Box Kit		
Part #	Qty	Description
02872	1	DRV Lower Coil Brkt
02873	1	PASS Lower Coil Brkt
02870	1	DS - Rr Outbrd Coil Mnt
02871	1	PS - Rr Outbrd Coil Mnt
05024	1	Dodge Rear Track Bar 6in
02879	1	6in Support Tube
911123	2	19in Sway Bar Link (Dodge RR)
02818	1	Dodge Rear Trackbar - Adj
A175	1	Forged End with 7/8 COM
02819	2	Com Adaptor - Dodge T-bar
03896	1	2019 Ram 3500 Rear Brake Line Bracket
01661	2	Fuel Line Relocation Bracket
146	1	sleeve 1.125 x .281 x 2.420 - knurl ends
03535BK	2	Bushing - black
516	1	1/4in - 28 Grease Zerk (#60105)
93	4	.75 x .134 x 1.575 Rolled Sleeve
M02016BK	4	Large Hourglass Bush M00489-BK-01- black
01457	2	1.250 x .281 x .625 Spacer Sleeve
02883	4	RR Outbrd Coil Mnt-Ram - Outer Nut Tab
02884	1	RR Outbrd Coil Mnt-Ram-Inner Nut Tab DS
02885	1	RR Outbrd Coil Mnt-Ram-Inner Nut Tab PS
75	2	1.25 x 5/16 x .50 DOM Sleeve
M20500-BK-01	2	Bump Stop Bushing
N38FLG	2	3/8-16 Flange Nut Clear Zinc
NP54801	1	1/2-13 Taper Hand Tap
01572	2	BDS Badge (3.920")
BP1023	1	Bolt Pack - Track Bar & Brakes
	2	9/16"-12 x 4" Bolt, Grade 8, Yellow Zinc
	4	9/16" SAE Washer, Yellow Zinc
	2	9/16"-12 Prevailing Torque Nut, Yellow Zinc
	2	3/8"-16 x 1-1/2" Bolt, Grade 8, Yellow Zinc
	2	3/8" SAE Washer, Yellow Zinc
	2	3/8"-16 Serrated Edge Flanged Nut, Clear Zinc
	1	1/2"-13 x 3" Bolt, Grade 8, Yellow Zinc
	1	1/2" SAE Washer, Yellow Zinc
	1	1/2"-13 Serrated Edge Flanged Nut, Clear Zinc
	2	1/4"-20 x 3/4" Bolt, Grade 5, Clear Zinc
	2	1/4" USS Washer, Clear Zinc
	2	1/4"-20 Serrated Edge Flanged Nut, Clear Zinc

012627 Box Kit		
685	1	Bolt Pack - Coil Spring Mounts
	8	1/2"-13 x 1-1/2" Bolt, Grade 8, Yellow Zinc
	12	1/2" SAE Washer, Yellow Zinc
	4	10mm-1.50 x 30mm, Class 10.9 - Black Oxide Flat-Head Socket cap Screw
	4	1/2"-13 x 1-3/4" Bolt, Grade 8, Yellow Zinc
	2	7/16"-14 x 1-1/2" Bolt, Grade 8, Yellow Zinc
	4	7/16" SAE Washer, Yellow Zinc
	2	7/16"-14 Prevailing Torque Nut, Yellow Zinc
687	1	Bolt Pack - Sway Bar Link
	4	12mm-1.75 x 70mm Bolt, Class 10.9, Clear Zinc
	4	12mm-1.75 Prevailing Torque Nut, Clear Zinc
	8	7/16" USS Washer, Clear Zinc
356	1	Bolt Pack - Brake Line
	2	5/16"-18 x 1" Bolt, Clear Zinc
	4	5/16" SAE Washer, Clear Zinc
	2	5/16"-18 Prevailing Torque Nut, Clear Zinc
	1	8mm-1.25 Prevailing Torque Nut, Clear Zinc
	1	1/4" USS Washer, Clear Zinc
354	1	Bolt Pack - E-brake
	2	3/8"-16 x 1-1/4" Bolt, Grade 8, Yellow Zinc
	4	3/8" SAE Washer, Yellow Zinc
	2	3/8"-16 Prevailing Torque Nut, Yellow Zinc
887	2	Bolt Pack - Badge
	2	1/8" Stainless Steel Blind Rivet

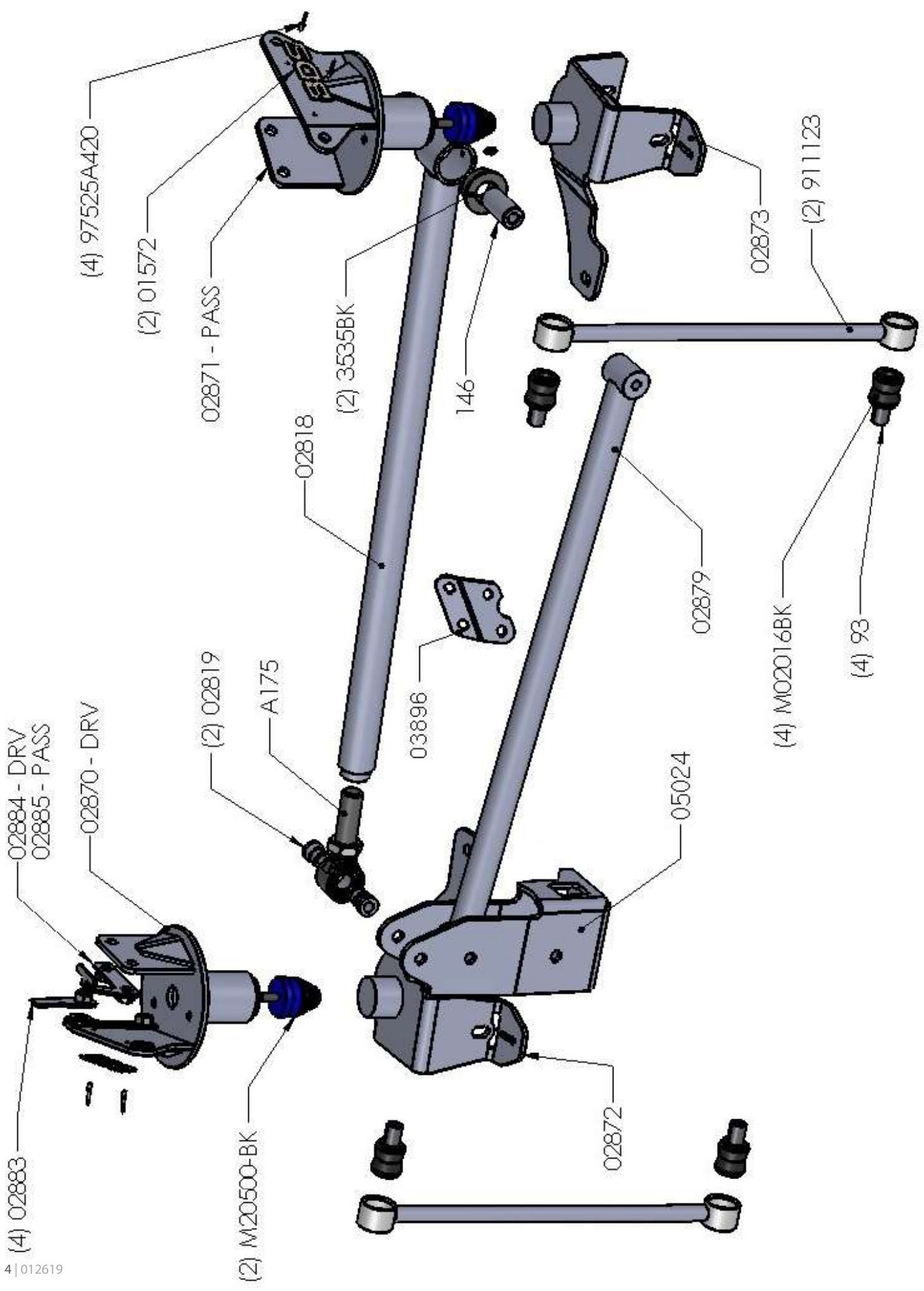



## TECH TIPS

### TROUBLESHOOTING INFORMATION FOR YOUR VEHICLE

1. If rear driveline vibration is present, order BDS # 122007 to increase driveshaft spline engagement. at the transfer case output. (Non High Output Vehicles only)
2. Upgraded transmission output shaft recommended for vehicles with aftermarket programmers. There will be increased stress on the drive train with the heavier than stock wheel and tire combination and also 1/4" less engagement on the transmission output shaft. Drive accordingly.
3. Kit is for Ram 2500 coil spring equipped vehicles only. It will not fit rear Air Ride Equipped vehicles.

## INSTALLATION INSTRUCTIONS

### INSTALLATION INSTRUCTIONS

1. Park vehicle on clean, flat, and level surface. Block the front wheels for safety.
2. Remove the rear track bar from the vehicle. Retain all hardware.
3. Raise the rear of the vehicle and support the frame rails with jack stands.
4. Remove the rear wheels.
5. Support the rear axle with a hydraulic jack.
6. Disconnect the rear brake line bracket from the differential. (Fig 1)

### SPECIAL TOOLS

Drill Bits and Drill  
Jackstands and Hydraulic Jack.

**FIG 1**



7. Disconnect the Driver side e-brake cable from the frame on the driver side right in front of the UCA frame mount to provide addition slack during Install (Fig 2)

**FIG 2**



8. Remove the factory sway bar links.
9. Disconnect the rear shocks. To access the top shock hardware, either remove the inner fender liner or trim the inner fender as shown. (Fig 3)

**FIG 3**



10. Lower the axle and remove the factory coil springs; retain both coil spring isolators.
11. Remove the factory bump stop brackets from the frame rail, bump stops. (Fig 4)

**FIG 4**





## LOWER BRACKET INSTALLATION:

12. Remove the rear brake line bracket hardware from the backside of the axle, discard hardware. (Fig 5)

**FIG 5**



13. Place the lower coil mount bracket over the factory bump stop pad and mark the center of the hole on the backside of the axle. Drill out to 27/64"; if drill bit is unavailable, use a 7/16". (Fig 6)
14. Hand tap the holes to 1/2"-13 with the included tap. Tapping trick: Use a 12 point 5/16" (8mm) socket that fits on the head of the tap with a ratchet to cut threads. Use lubricant on tap to aid in cutting threads. (Fig 6) Do NOT use an impact!

**FIG 6**



15. Enlarge the holes on the factory lower coil buckets to 1/2" - 9/16", where the new lower coil seat brackets will be placed. (Fig 7)

**FIG 7**

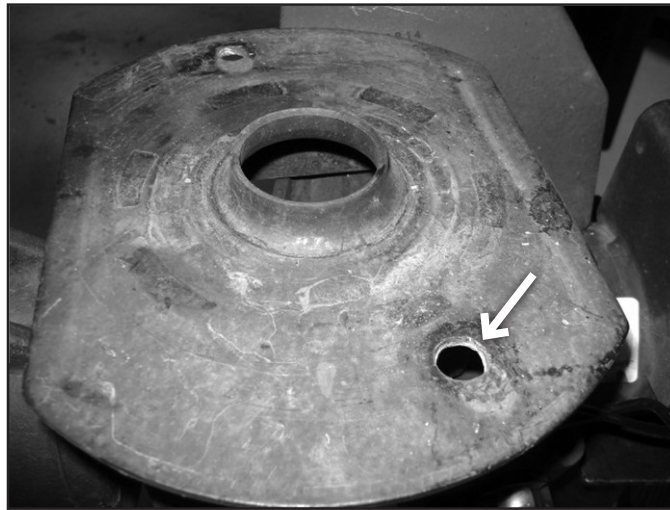

16. Place the lower coil seat brackets on the axle. Use the wide spacer at the rear (#01457) and the thinner spacer (#75) at the front side of the axle to space out the bracket. Attach brake lines to the new bracket with included 1/4" hardware (BP# BP1023) (Fig 8, 9)

**FIG 8 (WIDE SPACER)**

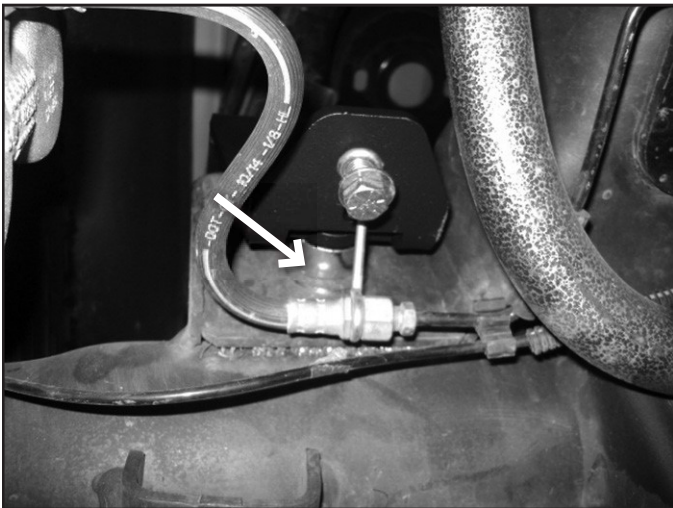

**FIG 9 (NARROW SPACER)**



17. Attach the brackets to the original lower bump stop pad with 1/2" hardware, leave loose at this time. (Fig 10)

**FIG 10**





18. Place the new trackbar bracket onto the OEM mount. Align holes and attach with hardware as shown. Place the 2-1/8" long sleeve in the place of the factory track bar location to prevent the bracket from collapsing. Brake line on the driver's side may need to be formed slightly to clear the bracket. (Fig 11, 12)

**FIG 11**

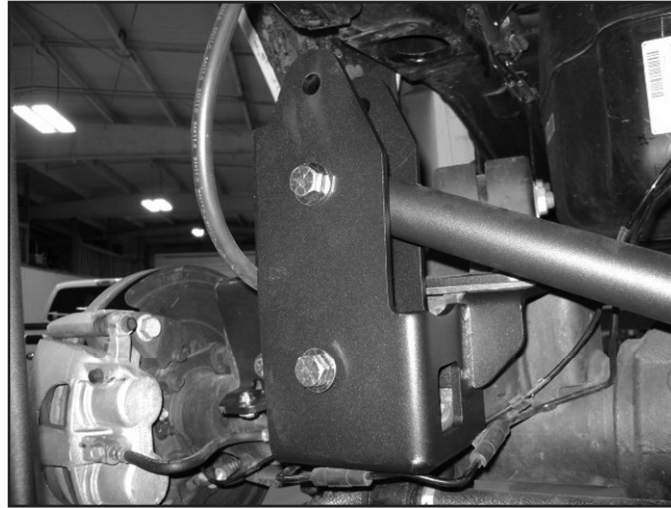

**FIG 12**

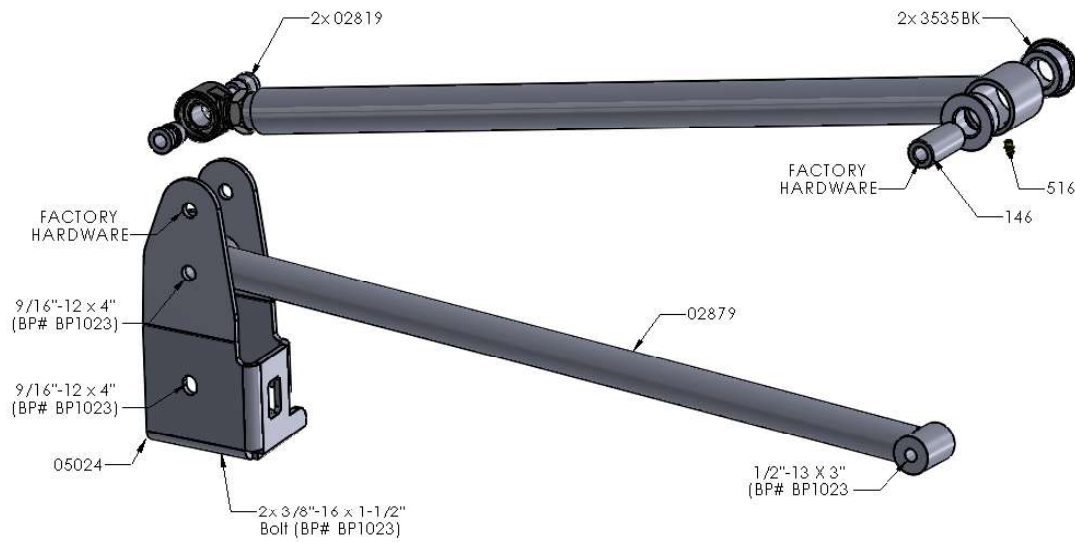

19. Install the trackbar support brace into the trackbar bracket with 9/16" hardware; do not tighten at this time. Swing the brace up to the passenger's side of the axle. Mark center of mounting tube and drill out to 1/2". Attach with 1/2" hardware and serrated edge flanged nut inside the factory bracket. Check for sway bar range of motion before drilling hole. Adjust support bar up higher if necessary. (Fig 13)

**FIG 13**



20. Install 7/16" hardware through the coil relocation mount. Tighten the 7/16" & 1/2" lower coil bracket hardware to 55 ft-lbs. Tighten the 3/8" bolt to 35 ft-lbs, 9/16" bolt in the original factory hole to 95 ft-lbs. Do not tighten the support tube hardware at this time, it will make installing the trackbar difficult.

### **UPPER BRACKET INSTALLATION:**

21. Install the new urethane bump stop to each of the upper coil spring mounts (02870 – Driver, 02871 – Passenger) through the clearance hole on the top side using the provided 3/8" serrated edge nut. It is easiest to use a 6" extension with a 9/16" short well socket to attach the bump stop to the mount. Tighten nut securely. (Fig 14)

**FIGURE 14**

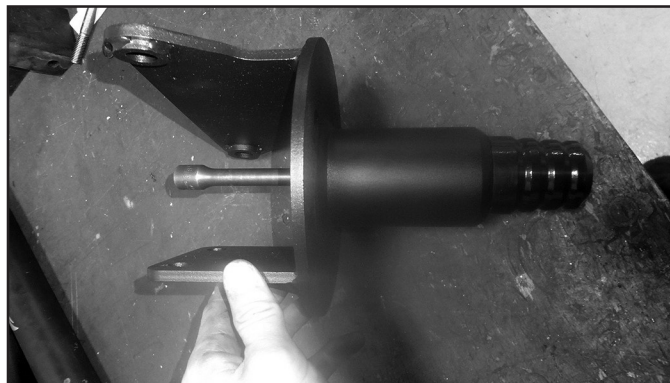

22. Install the upper coil spring mounts (02870 – Driver, 02871 – Passenger) with new 10mm flat-head socket cap screws (BP 685) to the bump stop mounts on the frame (Figure 15). Be sure to start both of the 10mm flat head socket cap screw before tightening them down. Mark the 4 holes to be drilled to attach the upper coil spring mount to the frame, and then remove the upper coil spring mount (Figure 16). Drill all 4 holes to 9/16" for both the passenger and driver sides (Figure 17)



**FIGURE 15**



**FIGURE 16**



**FIGURE 17**



23. Apply Thread locker to the 10mm flat-head socket cap screw and re-install the upper coil spring mounts to the bump stop mounts on the frame. Tighten to 35 ft-lbs.

24. Starting on the outside of the frame, insert a nut tab through the slot above the coil spring mount (Figure 18). Line up the nut on the nut tab with the previous drilled hole (Figure 19) and attach using a 1/2" x 1-1/2" bolt and washer (BP 685). Repeat for both outside holes on the upper coil spring mount (Figure 20). On the inside of the frame, insert a nut tab through the slot above the coil spring mount (Figure 21). The inside nut tabs are side specific (Figure 22). Line up the nuts on the nut tab with the two previously drilled holes and attach using two 1/2" x 1-1/2" bolt and washer. Tighten all 1/2" hardware to 65 ft-lbs.

**FIGURE 18**

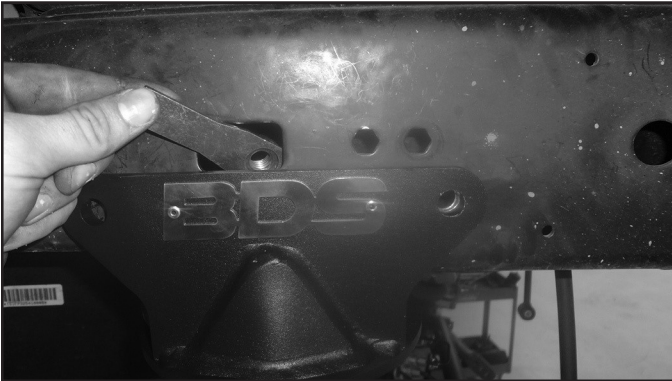

**FIGURE 19**



**FIGURE 20**



**FIGURE 21**

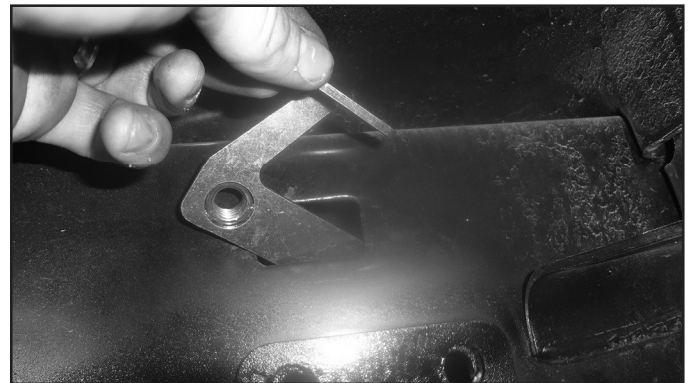

**FIGURE 22**

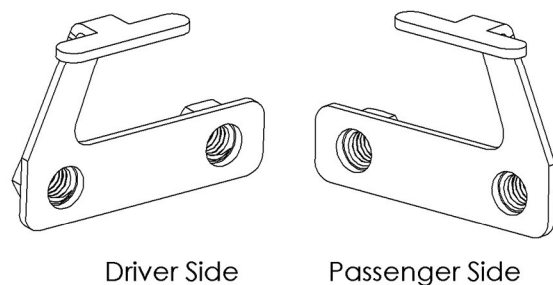

25. The badge can now be riveted on to the sway bar drops using the provided 1/8" rivets. Any residue on the badge can be cleaned up using alcohol or brake cleaner before install. With the badge not installed it can be painted to what ever color you desire, or left raw as a stainless steel badge. (Fig 23)

## **COIL AND SHOCK INSTALLATION:**

26. Install the new coil adaptor into one end of the coil. Attach the small OEM rubber coil isolator onto the other end of the coil. Install the coil with the new isolator at the upper mount and factory isolator at the lower mount. (Fig 23, 24)



**FIG 23**



**FIG 24**

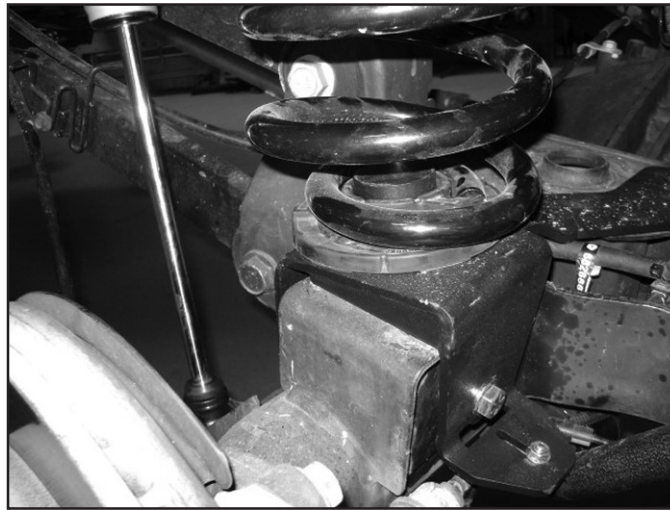

27. Drill out the small hole inside the frame behind the shock mounting hole to 3/8".
28. Grease and install bushings and sleeves into the shocks. Attach the clevis brackets to the shocks with included hardware. Tighten 1/2" eliminator hardware to 75 ft-lbs. Install the shocks into the vehicle. Tighten 3/4" hardware to 120ft-lbs. The locating tab on the clevis bracket will go into the factory hole that was drilled out, ensure it is installed correctly, the bracket will offset the shock rear-ward. (Fig 25)

**FIG 25**



29. Attach shocks to the axle with factory hardware. Tighten to 65 ft-lbs.

30. Grease and install bushings and sleeves into the sway bar links. Install sway bar links with 12mm hardware (#687). Tighten to 45ft-lbs. (Fig 26)

**FIG 26**



31. Remove the passenger side brake hardline from the passenger side of the differential cover. (Fig 27)

**FIGURE 27**



32. Attach the supplied brake line tab to the passenger side hard line with the supplied 5/16" hardware (Bolt Pack 354) and then the tab to the differential cover with the supplied washer and 8mm nut. Torque all hardware to 21 ft-lbs. (Fig 28)

**FIGURE 28**



33. Attach the supplied rear brake line bracket to the top of the rear differential cover with factory hardware. Torque to 12 ft-lbs. Use the provided 3/8" hardware (Bolt Pack 356) and fasten the factory brake line bracket to the supplied brake line bracket. Torque hardware to 26 ft-lbs. (Fig 29)

**FIGURE 29**

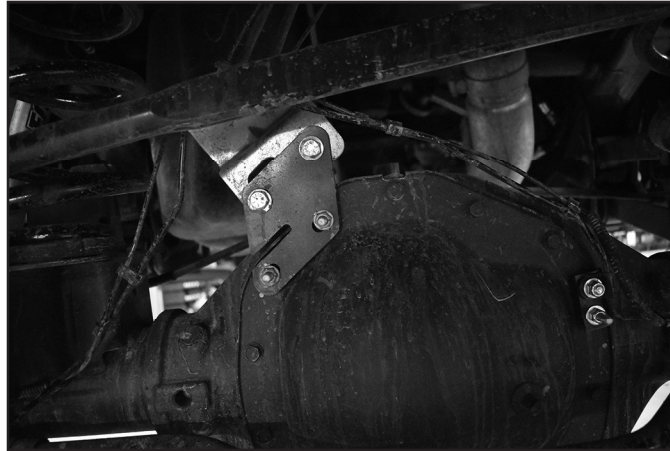

34. Attach the supplied brake line tab to the driver side e-brake line with the supplied 5/16" hardware (Bolt Pack 354) and then the tab to the driver side frame with factory hardware. Torque all hardware to 21 ft-lbs. (Fig 29)

**FIGURE 30**

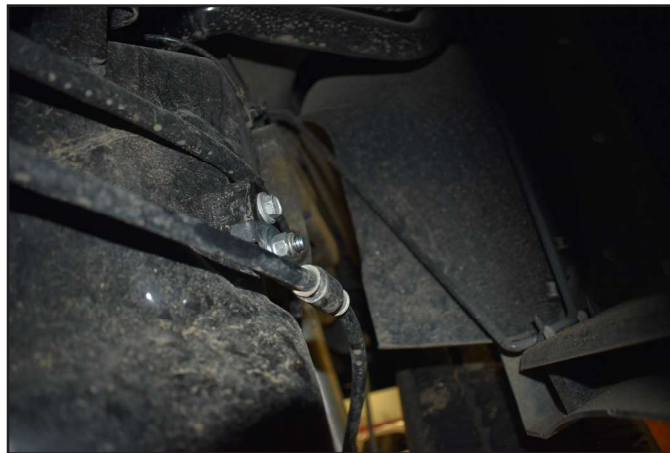

## **TRACK BAR INSTALLATION:**

35. Grease and install bushings and sleeve into adjustable trackbar. Install grease zerk into eyelet. Install COM bearing adaptors into the adjustable end.
36. Adjust trackbar to the same length as the stock trackbar.
37. Install the COM bearing end of the track bar into the relocation bracket at the axle with the factory bolt and flagged nut. Tighten all trackbar hardware including the support tube hardware at this time. Tighten 9/16" to 130 ft-lbs & factory 14mm hardware to 140 ft-lbs, 1/2" hardware to 90 ft-lbs. Use a wrench to hold the factory flagged nut to keep from spinning. (Fig 31)



**FIG 31**

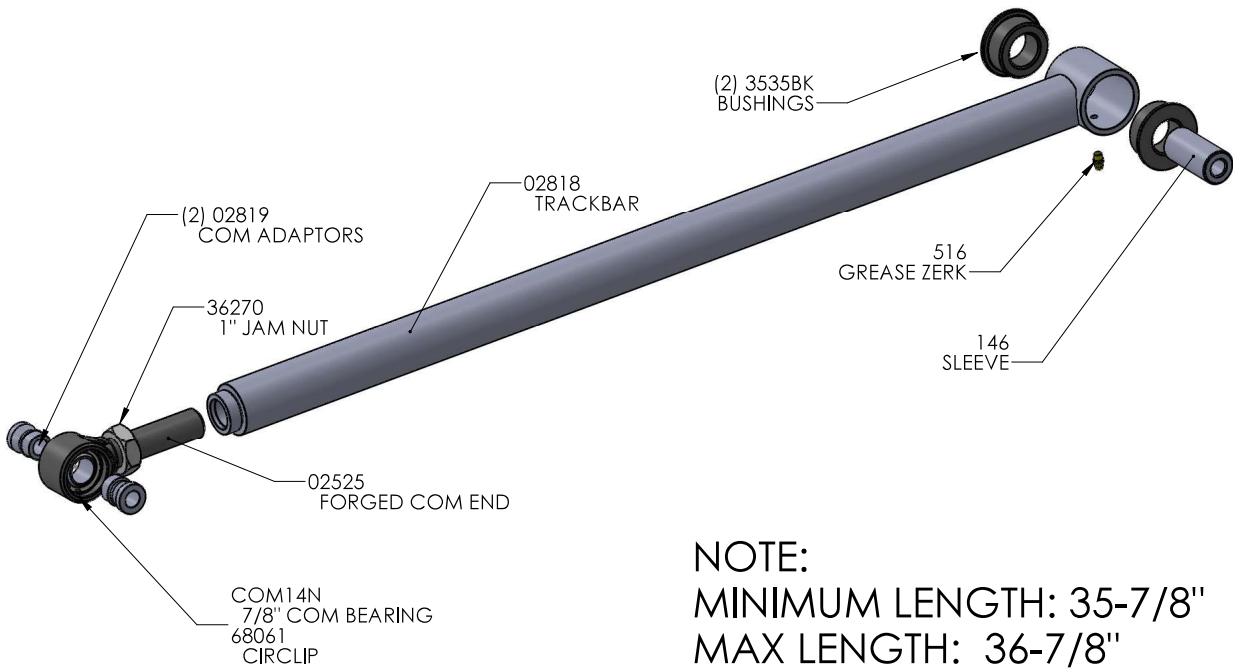

**NOTE:**  
MINIMUM LENGTH: 35-7/8"  
MAX LENGTH: 36-7/8"

38. Lower vehicle to the ground. Grease the bushing faces and install trackbar into the frame mount on the passenger's side with urethane bushings with factory hardware. Tighten frame mount to 156 ft-lbs. Grease the trackbar at this time.
39. Recheck all hardware for proper torque. Check again after 500 miles.
40. A front end alignment is required with the addition of a front end lift. Do not drive the vehicle with the steering wheel off-center or traction control problems may arise.



### **WE WANT TO SEE YOUR RIDE!**

Grab photos of your BDS-equipped truck in action and send them in for a chance to be featured. Send it in to our Bad Ass Rides customer gallery at [bds-suspension.com/bar](http://bds-suspension.com/bar) and post them on the BDS Fan Page on Facebook at [facebook.com/BDSSuspensions](https://facebook.com/BDSSuspensions). Don't forget about your BDS swag! BDS offers t-shirts, hoodies, decals and more available on the BDS website or through your local BDS distributor.

## **TIME TO HAVE SOME FUN**

**Thank you for choosing BDS Suspension.**

For questions, technical support and warranty issues relating to this BDS Suspension product, please contact your distributor/installer before contacting BDS Suspension directly.