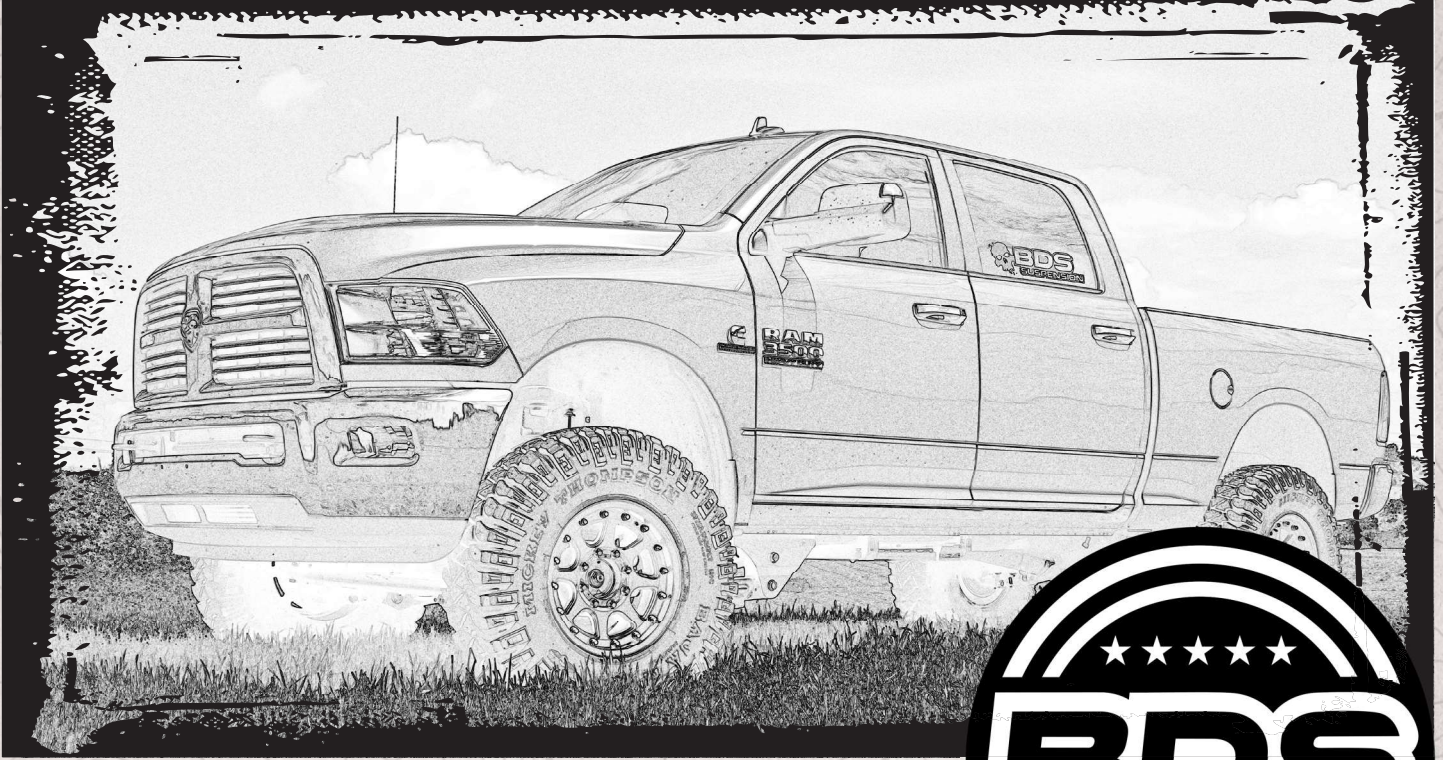


INSTALLATION GUIDE



Part#: 122616



HARDCORE LIMITED LIFETIME WARRANTY

Transfer Case Indexing Ring Kit - GAS

Dodge 2500 | 2014-18

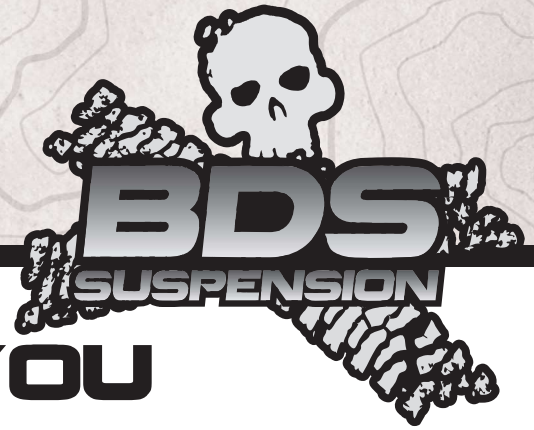
Dodge 3500 | 2013-18

Rev. 043019

491 W. Garfield Ave., Coldwater, MI 49036 • Phone: 517-279-2135

Web: www.bds-suspension.com • E-mail: tech-bds@ridefox.com

Read And Understand All Instructions And Warnings Prior To Installation Of System And Operation Of Vehicle.



THANK YOU

Your truck is about to be fitted with the best suspension system on the market today. That means you will be driving the baddest looking truck in the neighborhood, and you'll have the warranty to ensure that it stays that way for years to come. Thank you for choosing BDS Suspension!

BEFORE YOU START

BDS Suspension Co. recommends this system be installed by a professional technician. In addition to these instructions, professional knowledge of disassembly/ reassembly procedures and post installation checks must be known.

FOR YOUR SAFETY

Certain BDS Suspension products are intended to improve off-road performance. Modifying your vehicle for off-road use may result in the vehicle handling differently than a factory equipped vehicle. Extreme care must be used to prevent loss of control or vehicle rollover. Failure to drive your modified vehicle safely may result in serious injury or death. BDS Suspension Co. does not recommend the combined use of suspension lifts, body lifts, or other lifting devices. You should never operate your modified vehicle under the influence of alcohol or drugs. Always drive your modified vehicle at reduced speeds to ensure your ability to control your vehicle under all driving conditions. Always wear your seat belt.

BEFORE INSTALLATION

- Special literature required: OE Service Manual for model/year of vehicle. Refer to manual for proper disassembly/reassembly procedures of OE and related components.
- Adhere to recommendations when replacement fasteners, retainers and keepers are called out in the OE manual.
- Larger rim and tire combinations may increase leverage on suspension, steering, and related components. When selecting combinations larger than OE, consider the additional stress you could be inducing on the OE and related components.
- Post suspension system vehicles may experience drive line vibrations. Angles may require tuning, slider on shaft may require replacement, shafts may need to be lengthened or trued, and U-joints may need to be replaced.
- Secure and properly block vehicle prior to installation of BDS Suspension components. Always wear safety glasses when using power tools.
- If installation is to be performed without a hoist, BDS Suspension Co. recommends rear alterations first.
- Due to payload options and initial ride height variances, the amount of lift is a base figure. Final ride height dimensions may vary in accordance to original vehicle attitude. Always measure the attitude prior to beginning installation.



Visit 560plus.com for more information.

BEFORE YOU DRIVE

Check all fasteners for proper torque. Check to ensure for adequate clearance between all rotating, mobile, fixed, and heated members. Verify clearance between exhaust and brake lines, fuel lines, fuel tank, floor boards and wiring harness. Check steering gear for clearance. Test and inspect brake system.

Perform steering sweep to ensure front brake hoses have adequate slack and do not contact any rotating, mobile or heated members. Inspect rear brake hoses at full extension for adequate slack. Failure to perform hose check/ replacement may result in component failure. Longer replacement hoses, if needed can be purchased from a local parts supplier.

Perform head light check and adjustment.

Re-torque all fasteners after 500 miles. Always inspect fasteners and components during routine servicing.

CONTENTS OF YOUR KIT

Indexing Ring		
Part #	Qty	Description
A238	1	Indexing Ring Assembly
02296	1	Drive Shaft Spacer
	1	Thread Locker
932	1	Bolt Pack - Front Drive Shaft Spacer
	4	7/16"-14 x 2-1/4" Flanged head bolt
950	1	Bolt Pack
	6	10mm-1.50 x 30mm Flat head socket cap screw
	6	3/8"-24 hex nut
	6	3/8" cadmium plated washer

Transmission Crossmember Kit		
Part #	Qty	Description
02729	1	2013 Dodge transmission x-member - Gas
099000	6	Zip Tie

TROUBLESHOOTING INFORMATION FOR YOUR VEHICLE


1. The front driveshaft dual cardan may need clearanced on vehicles with a large amount of lift. Use a rotary grinding with carbide bit to eliminate any possible interference.
2. Cannot be used on 8-bolt t-case models.
3. 6.4L and 5.7L gas models require front exhaust modification.




**TECH
TIPS**

INSTALLATION INSTRUCTIONS

INSTALLATION INSTRUCTIONS

 **Tip** *The transmission output seal and transfer case input shaft have been redesigned from previous version trucks. There is no longer a need for a seal extension with replacement seal. Do NOT remove the transmission output seal!*

1. Park vehicle on clean, flat, and level surface. Block the rear wheels for safety.
2. Remove the transfer case skid plate if equipped, it will not be reinstalled.
3. Remove the rear driveshaft, retain hardware. Disconnect the front driveshaft from the transfer case. (Fig 1a, 1b).

 **Tip** *To aid in removal of the front driveshaft, first remove the hardware from the axle end. Next, remove the driveshaft from the transfer case end using a combination of swivels and extensions. The driveshaft will need to be rotated to access all four of the bolts for the driveshaft.*

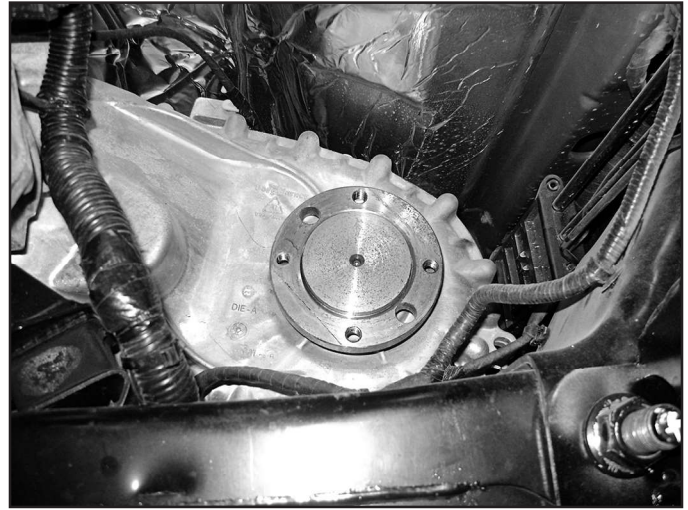
SPECIAL TOOLS

Transmission jack is highly recommended

FIGURE 1A



FIGURE 1B

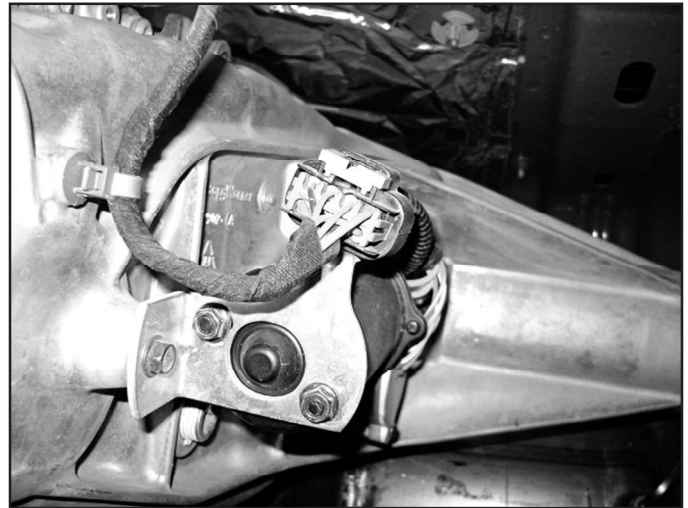


4. Disconnect the wire harness that controls the transfer case, manual shift linkage transfer cases will look slightly different. (Fig 2a, 2b)

FIGURE 2A

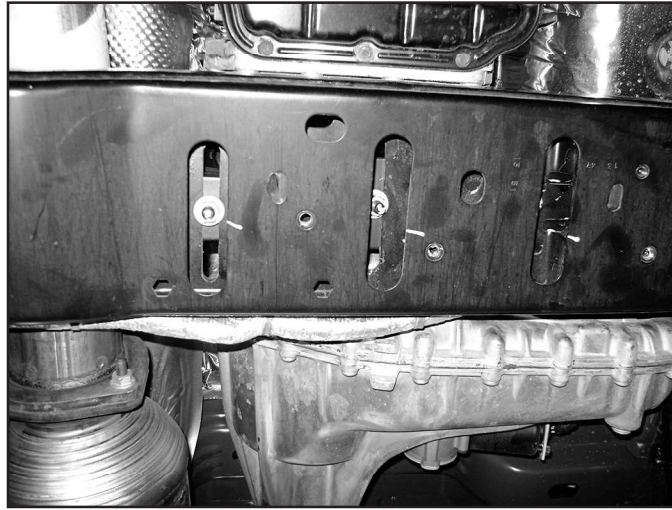


FIGURE 2B



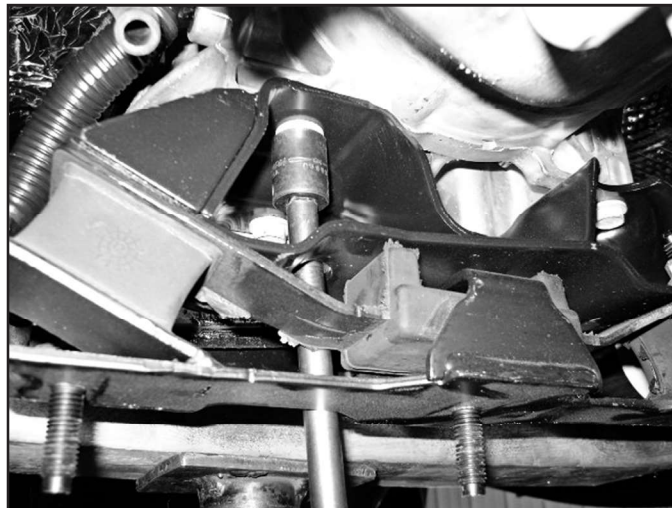
5. Disconnect the breather vent tube from the top of the transfer case.
6. Remove the 3 nuts that hold the transmission mount to the transmission crossmember. (Fig 3)

FIGURE 3



7. Support the transmission with a jack.
8. Remove the transmission crossmember and retain hardware.
9. Remove the mounting brackets that hold the transmission to the crossmember. (Fig 4)

FIGURE 4



10. Manual shift transfer cases: Disconnect the shift linkage from the transfer case, retain all hardware (Fig 5a, 5b).

FIGURE 5A



FIGURE 5B



11. Remove the 6 nuts that hold the transfer case to the transmission and remove the transfer case from the vehicle. Use extra caution as the transfer case is very heavy.

12. Remove the 6 studs by double nutting the studs. Place new indexing ring up to the transfer case. Attach with 10mm flat head allen bolts (BP #950). Note there is a specific orientation and the indexing ring will need to be rotated to get the proper hole alignment. (Fig 5a, 5b, 5c)

FIGURE 5A

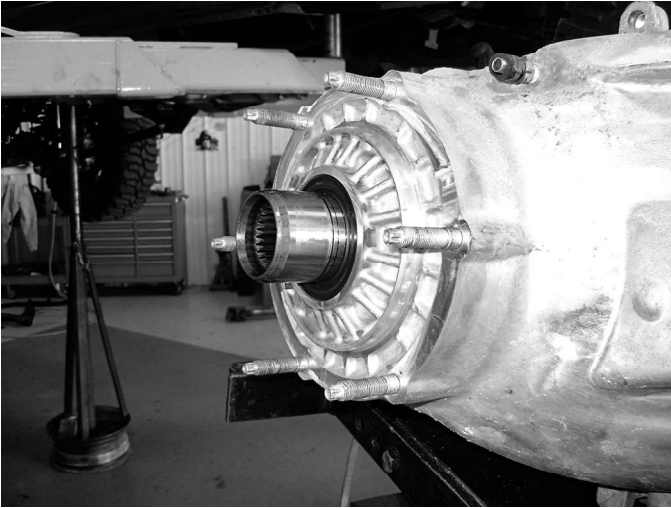


FIGURE 5B

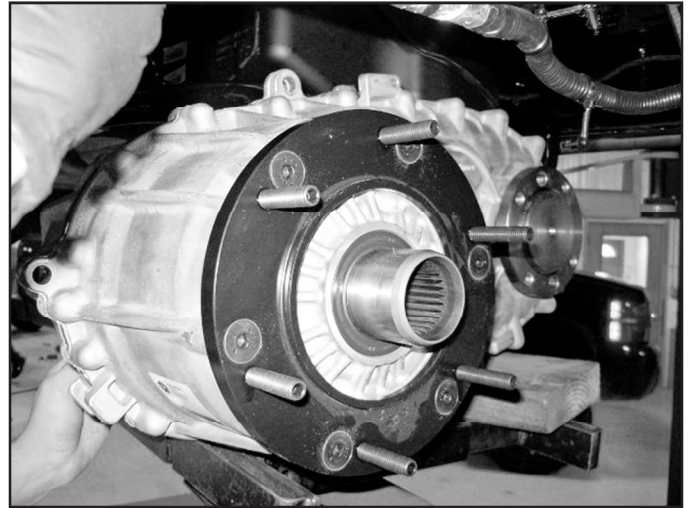
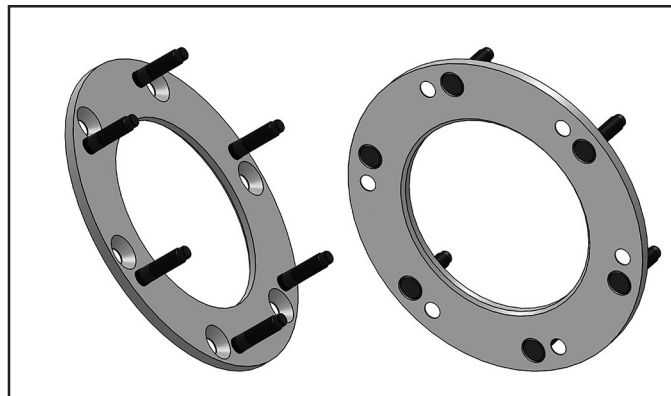


FIGURE 5C




13. Reinstall the transfer case and tighten with 3/8" fine thread nuts with washers. Loc-tite and tighten to 45 ft-lbs. Note: This torque applies with the thread locker still slightly damp and acting as a lubricant. The max recommended torque is 55 ft-lbs when rechecking hardware.
14. Disconnect the wire harness on the frame rail, reroute the wires to the transmission / transfer case above the front driveshaft. (Fig 6a, 6b)

FIGURE 6A



FIGURE 6B



 **Tip** Before hooking up the front driveshaft, now is a great time to grease the nearly impossible to access grease fitting on the front dual cardan joint. A needle adaptor on a grease gun is required. This fitting is required to be serviced at every oil change interval. Ensure that this maintenance is not skipped!

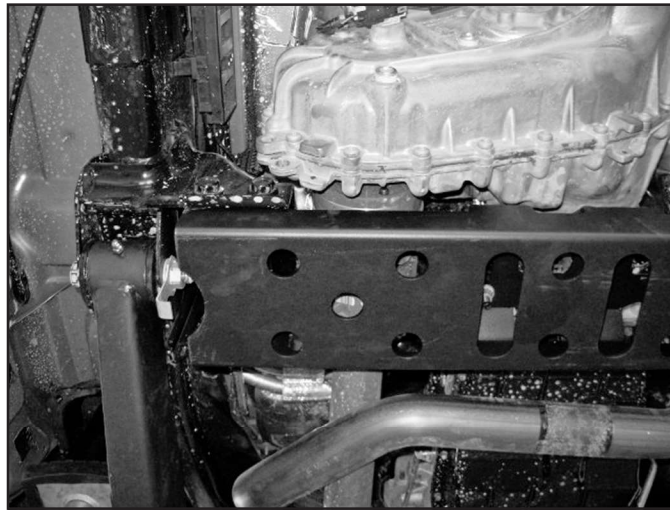
15. Reattach the front driveshaft with driveshaft spacer to the transfer case with new 7/16" hardware with loc-tite on the threads. Tighten to 75 ft-lbs (Fig 7). For 6.4L or 5.7L gas models see last step for exhaust modification.

FIGURE 7



16. Reinstall the transmission mount with factory hardware.
17. Install new crossmember with factory bolts. If this installation is combined with a BDS 4-link kit the nuts will not be put on at this time, and will need to be installed with the 4-link brackets. The hardware may need to be run from rear to front to clear the transfer case. Raise the transfercase and transmission assembly to get clearance for the bolt to be installed. Otherwise tighten to 150 ft-lbs. (Fig 8)

FIGURE 8



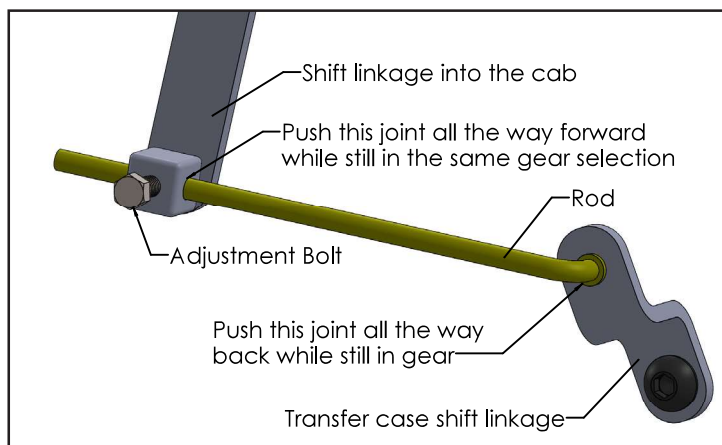
18. Attach transmission mount with factory nuts. Tighten to 40 ft-lbs.
19. Attach the wiring to the transmission crossmember with the provided zip ties and secure wires to keep them clear of any rotating parts or exhaust..
20. Manual Shift Transfer Case: Reconnect the shift linkage to the transfer case. The adjuster may need to be loosened to allow the shift lever to rotate and line up with the linkage on the transfer case (Fig 9A). Additional adjustment may be necessary to get proper engagement in all gear ranges.

FIGURE 9A



21. When adjusting the shift linkage, it is best to keep the shift linkage in 2wd. Loosen the bolt attaching the rod to the shifter lever going into the cab of the truck (Fig. 9B).
22. Push the transfer case shifter linkage towards the back of the truck, making sure it is still in the correct position (2wd). Next push the shifter linkage going into the cab all the way forward while still making sure it is reading the correct position in the cab (2wd). Tighten the shifter linkage bolt to tighten down the shifter linkage to the rod connecting to the transfer case shifter linkage (Fig 9B). Additional adjustment may be necessary to get proper engagement in all gear ranges.

FIGURE 9B



23. Front exhaust modification is required on 6.4L gas models and some 5.7L gas models. Make sure adequate clearance is given to the front driveshaft before installation of the front driveshaft. The vehicle can be driven without the front driveshaft to an exhaust shop for modification and reinstalled after modification. This can also be performed by using heat and a hammer or clamp to bend the exhaust to provide clearance for the front driveshaft. Check the exhaust to drive shaft clearance at full droop for a worst case scenario.

FIGURE 10A



FIGURE 10B



24. Reinstall rear driveshaft with factory hardware with loc-tite on threads. Tighten to 75 ft-lbs.
25. Recheck all hardware for proper torque. Check again after 500 miles and at regularly scheduled maintenance intervals.
26. Manual Shift Transfer Case: If the shift linkage was adjusted, check to make sure the transfer case is shifted to the correct location for 4x4 HI, LO, and 2wd. Adjust as necessary.



WE WANT TO SEE YOUR RIDE!

Grab photos of your BDS-equipped truck in action and send them in for a chance to be featured. Send it in to our Bad Ass Rides customer gallery at bds-suspension.com/bar and post them on the BDS Fan Page on Facebook at facebook.com/BDSSuspensions. Don't forget about your BDS swag! BDS offers t-shirts, hoodies, decals and more available on the BDS website or through your local BDS distributor.

TIME TO HAVE SOME FUN

Thank you for choosing BDS Suspension.

For questions, technical support and warranty issues relating to this BDS Suspension product, please contact your distributor/installer before contacting BDS Suspension directly.