

INSTALLATION GUIDE

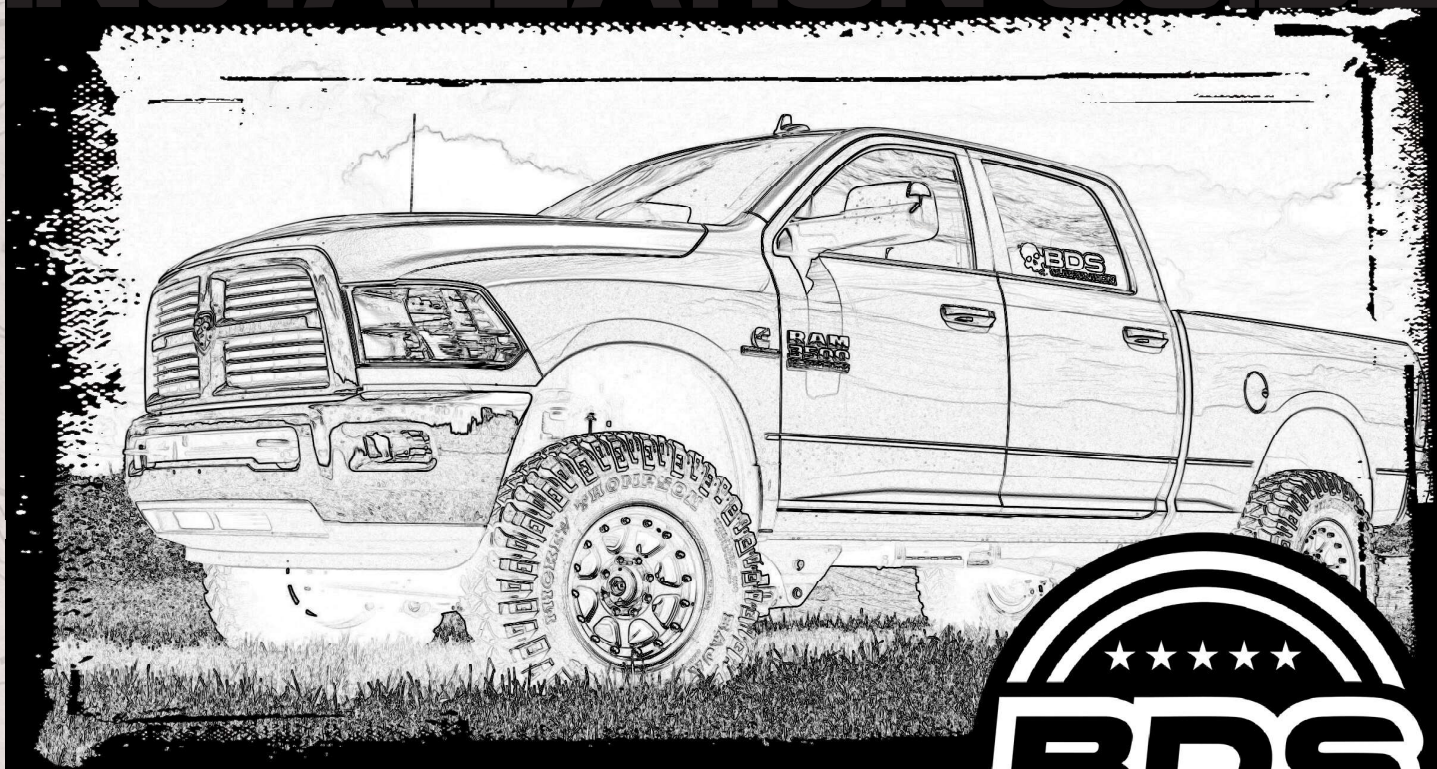

Part#: 012401



HARDCORE LIMITED LIFETIME WARRANTY

4" Radius Arm Drop Bracket Kit

Dodge Ram 3500 4WD Pickup | 2013-2018

Dodge Ram 2500 4WD Pickup | 2014-2018

Rev. 020524

491 W. Garfield Ave., Coldwater, MI 49036 • Phone: 517-279-2135

Web: www.bds-suspension.com • E-mail: tech-bds@ridefox.com

Read And Understand All Instructions And Warnings Prior To Installation Of System And Operation Of Vehicle.



THANK YOU

Your truck is about to be fitted with the best suspension system on the market today. That means you will be driving the baddest looking truck in the neighborhood, and you'll have the warranty to ensure that it stays that way for years to come. Thank you for choosing BDS Suspension!

BEFORE YOU START

BDS Suspension Co. recommends this system be installed by a professional technician. In addition to these instructions, professional knowledge of disassembly/ reassembly procedures and post installation checks must be known.

FOR YOUR SAFETY

Certain BDS Suspension products are intended to improve off-road performance. Modifying your vehicle for off-road use may result in the vehicle handling differently than a factory equipped vehicle. Extreme care must be used to prevent loss of control or vehicle rollover. Failure to drive your modified vehicle safely may result in serious injury or death. BDS Suspension Co. does not recommend the combined use of suspension lifts, body lifts, or other lifting devices. You should never operate your modified vehicle under the influence of alcohol or drugs. Always drive your modified vehicle at reduced speeds to ensure your ability to control your vehicle under all driving conditions. Always wear your seat belt.

BEFORE INSTALLATION

Special literature required: OE Service Manual for model/year of vehicle. Refer to manual for proper disassembly/reassembly procedures of OE and related components.

Adhere to recommendations when replacement fasteners, retainers and keepers are called out in the OE manual.

Larger rim and tire combinations may increase leverage on suspension, steering, and related components. When selecting combinations larger than OE, consider the additional stress you could be inducing on the OE and related components.

Post suspension system vehicles may experience drive line vibrations. Angles may require tuning, slider on shaft may require replacement, shafts may need to be lengthened or trued, and U-joints may need to be replaced.

Secure and properly block vehicle prior to installation of BDS Suspension components. Always wear safety glasses when using power tools.

If installation is to be performed without a hoist, BDS Suspension Co. recommends rear alterations first.

Due to payload options and initial ride height variances, the amount of lift is a base figure. Final ride height dimensions may vary in accordance to original vehicle attitude. Always measure the attitude prior to beginning installation.

BEFORE YOU DRIVE

Check all fasteners for proper torque. Check to ensure for adequate clearance between all rotating, mobile, fixed, and heated members. Verify clearance between exhaust and brake lines, fuel lines, fuel tank, floor boards and wiring harness. Check steering gear for clearance. Test and inspect brake system.

Perform steering sweep to ensure front brake hoses have adequate slack and do not contact any rotating, mobile or heated members. Inspect rear brake hoses at full extension for adequate slack. Failure to perform hose check/ replacement may result in component failure. Longer replacement hoses, if needed can be purchased from a local parts supplier.

Perform head light check and adjustment.

Re-torque all fasteners after 500 miles. Always inspect fasteners and components during routine servicing.

TIRES AND WHEELS

FITMENT GUIDE

4" Lift:

37x12.50 w/ 5.625" Backspacing on 9" wide wheel

35x12.50 w/ 4.5" Backspacing on 9" wide wheel



CONTENTS OF YOUR KIT

012401		
Part #	Qty	Description
082405R	1	Pitman Arm
02446	1	Trackbar bracket
27031	1	Fish Wire
01797	1	1/2" Bolt Tab
01499	1	1/4" Spacer
02475	2	Dodge 4-6" brakeline relocation bracket
B561G2	2	5/16"-18 x 1" Type 23 self threading bolt
02470	2	Dodge weld in bung
02471	2	Dodge long machined spacer sleeve
02476	1	Rad arm drop brkt - Driver
02477	1	Rad arm drop brkt - Pass
95105A169	2	1/2" Rivet nuts
7	2	Spacer Sleeve
99000	2	Cable Tie
342701	1	Thread locker
02322BK	2	Bump Stop
799	1	Rivet nut installation bolt pack
	1	1/2"-13 x 2" bolt grade 8
	1	1/2" SAE flat washer
	1	1/2" star washer
	1	9/16"-18 high nut
792	1	Bolt Pack - Track bar Bracket
	1	1/2"-13 x 1-3/4" bolt - grade 8 - yellow zinc
	1	1/2"-13 Prevailing torque nut - yellow zinc
	1	1/2"-13 Nut (non locking) - yellow zinc
	3	1/2"-13 USS Washer - yellow zinc
	1	18mm-2.50 x 80mm bolt - class 10.9 clear zinc
	1	18mm-2.50 Prevailing torque nut - clear zinc
	2	3/4" SAE Washers - Clear zinc
793	1	Bolt Pack - Rad Arm Drop Brackets
	2	5/8"-11 x 5" bolt - grade 8 - yellow zinc
	4	5/8" USS Washer - yellow zinc
	2	5/8"-11 Prevailing torque nut - yellow zinc
	2	3/4"-10 x 5-1/2" bolt - grade 8 - yellow zinc
	4	3/4" SAE Thru hardened washer - yellow zinc
	2	3/4"-10 Prevailing torque nut - yellow zinc
	4	1/2"-13 x 1-1/4" bolt - grade 8 - yellow zinc
	4	1/2" USS Washer - yellow zinc

032401		
Part #	Qty	Description
032401R	1	DRV Coil
032402R	1	PASS Coil

032302		
Part #	Qty	Description
032302R	2	Gas 4" Coil

PRE INSTALLATION

IMPORTANT

It is required that ride height measurements be taken before and after installation. Measure from the **WHEEL AXLE CENTER** up to the **FENDER LIP** of the wheel opening. Do this for all 4 wheels. Record measurements below.**

BEFORE

Left Front _____ *Right Front* _____

Left Rear _____ *Right Rear* _____

AFTER

Left Front _____ *Right Front* _____

Left Rear _____ *Right Rear* _____

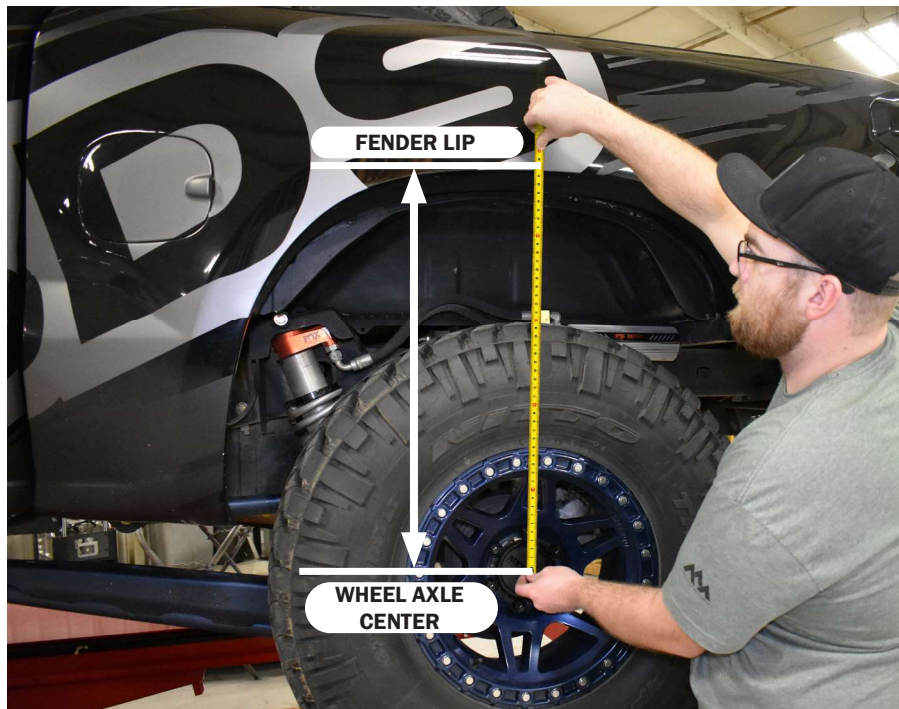

****These ride heights will be required if you have any ride height concerns after installation. Please be prepared to provide these to Technical Support.**

INSTALLATION INSTRUCTIONS

PRE INSTALLATION NOTES:

6.4L Gas models will require exhaust modification to clear the front driveshaft. 5.7L Gas models may require modification - but not in all cases. The vehicle can be driven without the front driveshaft to an exhaust shop for modification and reinstalled after modification.

SPECIAL TOOLS

- #1: Pitman arm puller
- #2: 11/16" drill (step drill highly recommended)
- #3: Welder

MEASURE FIRST

Measure and record from the center of the wheel up to the bottom edge of the wheel opening as shown on page 4.

RADIUS ARM INSTALLATION INSTRUCTIONS

1. Park vehicle on clean flat and level surface. Block the rear wheels for safety.
2. Disconnect the battery / batteries, welding will be required. Do not weld on the vehicle with the batteries connected.
3. Remove the front trackbar bolt from the frame rail. Retain all hardware. (Fig. 2)

FIGURE 1

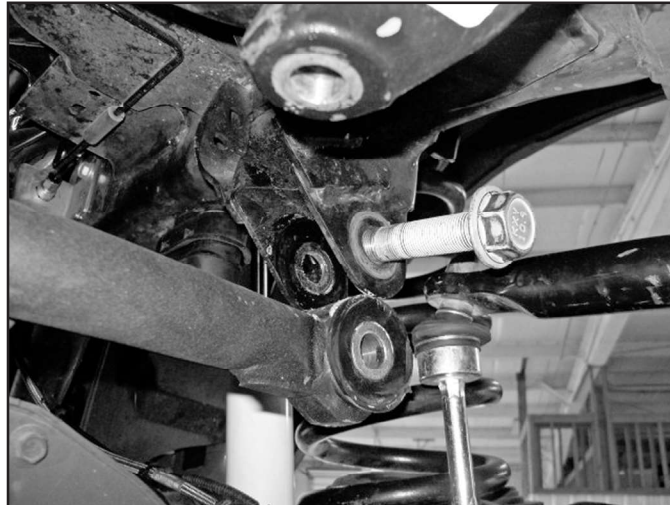

4. Raise the front of the vehicle and support the frame rails with jackstands. Do not support on the radius arms, they will be removed during the installation.

5. SUSPENSION DISASSEMBLY

6. Support the front axle with a hydraulic jack.
7. Remove the factory wheels, remove the retaining clips that hold the rotor on and may interfere with aftermarket wheels.
8. Break the jam nuts loose on the adjusting collar of the drag link. (Fig 2)

FIGURE 2

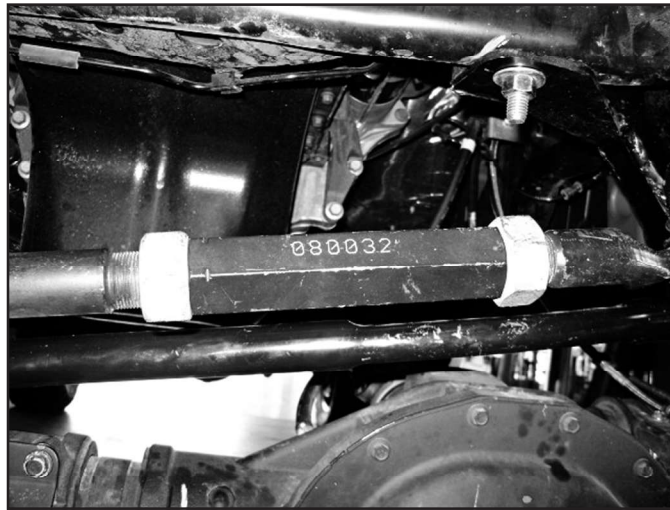

9. Disconnect the tie rod from the pitman arm, do not damage the tie rod boot. Mark the orientation of the pitman arm and remove the pitman arm from the sector shaft. (Fig. 3)

FIGURE 3



10. Disconnect the sway bar mounting hardware from the frame, and allow the sway bar to swing down. Retain all hardware. (Fig. 4)

FIGURE 4



11. Disconnect the brake line bracket from the top of the radius arm mount on the axle, retain bolt, discard bracket. (Fig. 5)

FIGURE 5

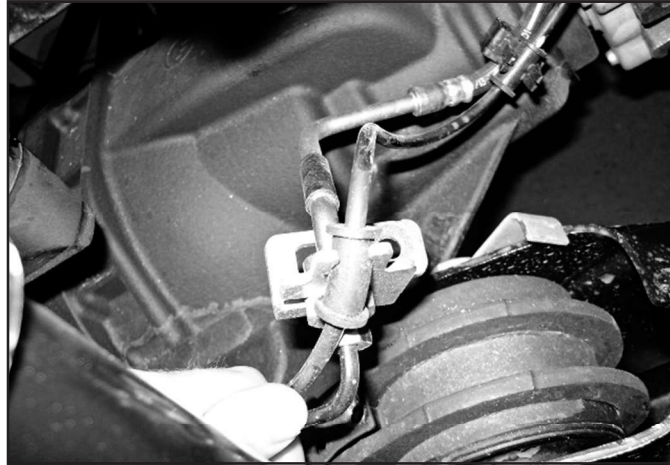

12. Disconnect the factory shock from the lower shock mount. (Fig. 6) Lower the front axle and remove the factory coil springs.

FIGURE 6



13. Raise the front axle and reattach factory shocks with factory bolt. It is not necessary to put the nut tab back on. The shocks will be there to keep the axle secure. Keep a jack under the axle for extra support.
14. Mark the cam at the axle. Remove the passenger's side radius arm. Retain all hardware. It will be necessary to remove the shock bolt and move the shock out of the way to get the upper hardware out. Reinsert the lower shock bolt when the arm is removed.

RADIUS ARM DROP BRACKET INSTALLATION

15. On the passenger's side only. Measure and mark as shown in Figure 7. This small amount of material will need to be removed for clearance to the new radius arm drop bracket. The inside edge of the cut will be flush with the transmission crossmember. The outside edge will be flush with the radius arm mounting plate. Measure up 1/4" and remove this material for clearance.

FIGURE 7

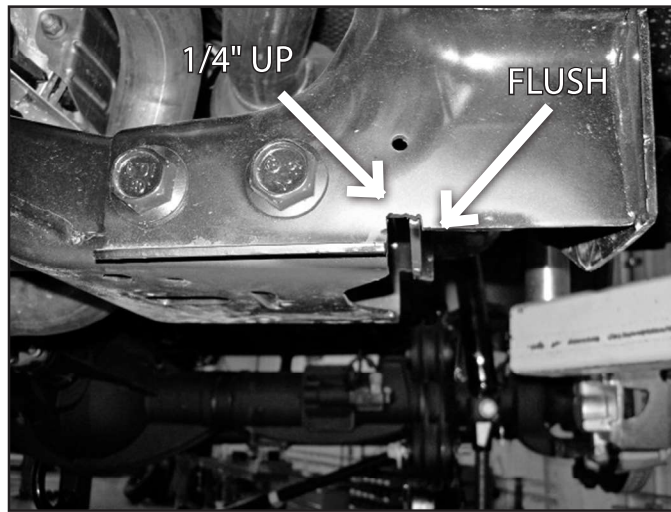

16. Place the radius arm drop bracket up to the frame rail. Insert $\frac{3}{4}$ " bolt to locate the bracket. Mark the center of the slot on the bottom of the frame rail, mark the center of the top, rear hole on the side of the frame rail. (Fig. 8)

FIGURE 8

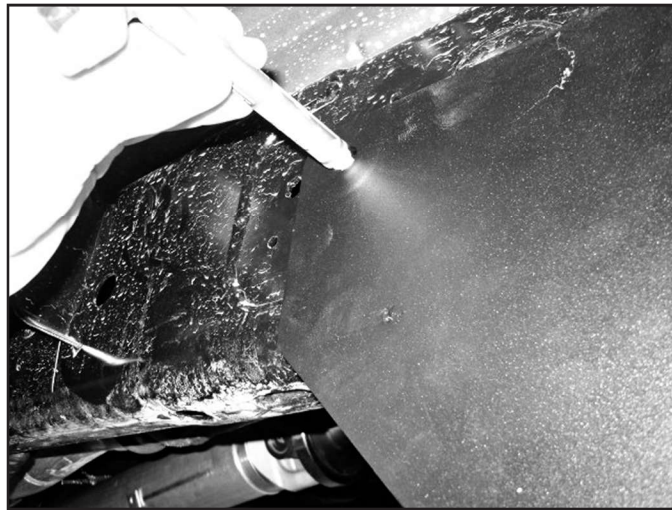

17. Remove the bracket and drill the 2 centers to $\frac{11}{16}$ ". Prep the area on the side of the frame rail for welding. Place the weld in bung into the hole and weld the bung into place. (Fig. 9)

FIGURE 9



18. Insert the rivet nut into the bottom of the frame rail. Use the hardware (#799) to set the rivet nut into place as shown (Fig. 10) See the end of the instruction sheet for detailed rivet nut installation instructions.

FIGURE 10



19. Place the machined sleeve into the existing frame rail hole. Reinstall the bracket with hardware (#793) and sleeve as shown. Torque 5/8" hardware to 150 ft lbs, 1/2" hardware to 80 ft lbs, and 3/4" hardware to 200 ft lbs. (Fig. 11A, 11B, 11C, 11D, 11E)

FIGURE 11A



FIGURE 11B

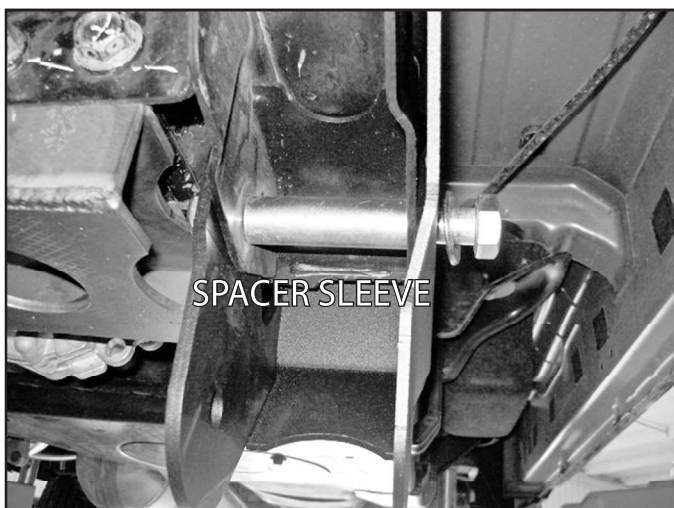

FIGURE 11C

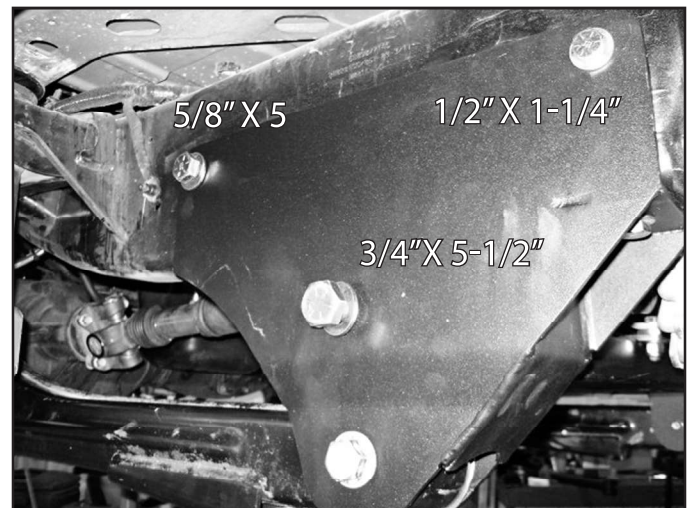

FIGURE 11D

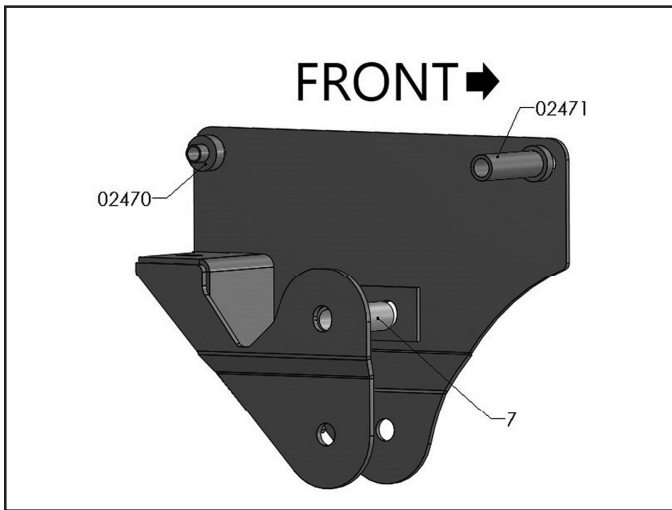
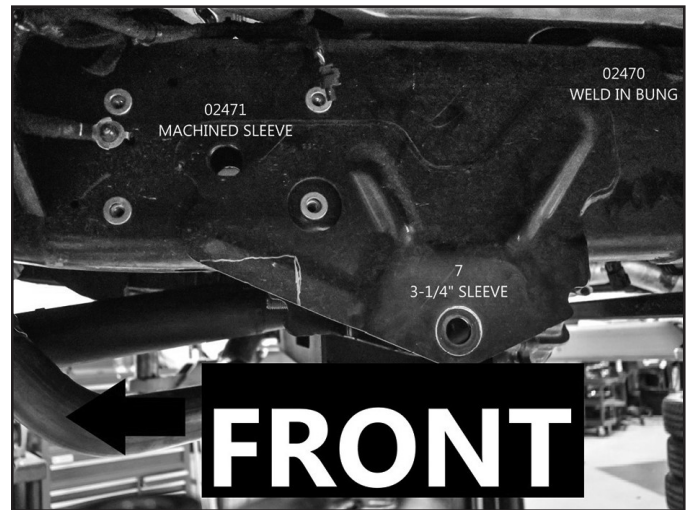

FIGURE 11E



20. With a jack still under the axle, disconnect the radius arm from the driver's side frame bracket. Reinstall the passenger's side radius arm with factory hardware. Rotate the cam to the marked position. Leave hardware slightly loose.
21. Repeat bracket installation procedure on the driver's side.



Tip *The trimming for clearance on the frame bracket is NOT required on the driver's side.*

22. Reinstall the driver's side radius arm with factory hardware. Rotate the cam to the position marked at the beginning of the installation. Snug all hardware, do not tighten at this time.

BUMP STOP INSTALLATION:

23. Remove the factory bump stops, it is easiest to hit them from side with a hammer to pop them out. (Fig. 12)

FIGURE 12



24. Grease new replacement bump stops and raise axle to press the bump stops into position. These will be a tight fit. It is easiest to lift the axle with a jack to compress the bump stops into position. (Fig. 13)

FIGURE 13



TRACK BAR BRACKET INSTALLATION

25. Install the trackbar bracket with factory bolt through the original trackbar hole.
26. Clearance the factory hole on the frame crossmember where the trackbar bracket meets to 9/16".
27. The upper slot in the trackbar bracket will align with the hole in the factory trackbar bracket. These holes have variations in their position, and minor grinding of the hole horizontally may be required. Clearance the hole so 1/2" hardware will fit through it. (Fig. 14)

FIGURE 14

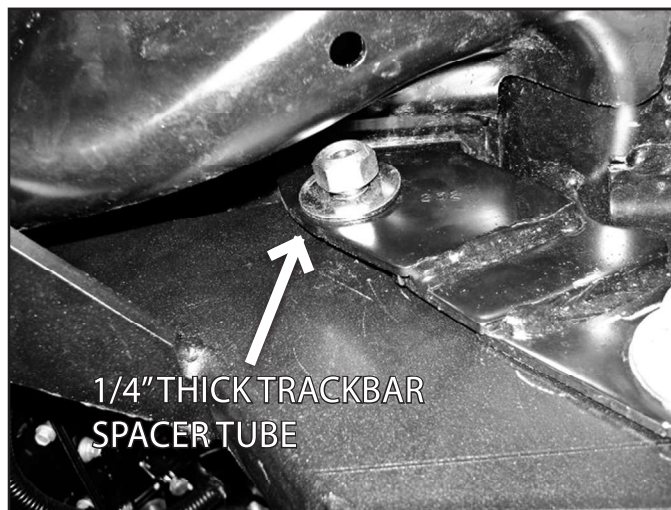

28. Fish the bolt tab through the frame rail with the included bolt wire and attach to the trackbar bracket with 1/2" USS washer and regular nut. Apply thread locker to the bolt threads. Attach the upper hole with 1/2" x 1-3/4 (#792) bolt with spacer washer as shown. (Fig. 15A, 15B)

FIGURE 15A



FIGURE 15B



29. Tighten 1/2" trackbar hardware to 65 ft-lbs. Tighten 18mm factory bolt to 150 ft-lbs.
30. Support front axle and remove the factory shocks. Retain the lower hardware, discard shocks and upper hardware.
31. **4" Diesel:** Lower the axle and install the new coils with factory isolator. The coils are side specific. They are marker "PASS" for the passenger side and nothing for the driver, install on the correct side of the vehicle. The windings of the coil that are close together will be located at the top (frame mount)
32. **4" Gas :** Lower the axle and install the new coils with factory isolator. The Driver's side coil will install with the isolator tab in the factory hole. The Passenger's side isolator will need to be rotated just over 45 degrees. Cut and place the template up to the factory mount, mark hole center and drill to 1/2". The upper isolator on the passenger's side is shown in the new hole. (Fig 16a, 16b, 16c, 16d) ONLY on the passenger's side.

FIGURE 16A



FIGURE 16B

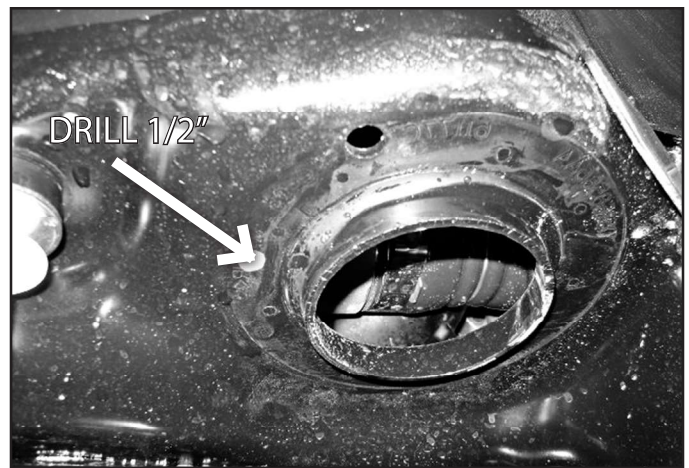
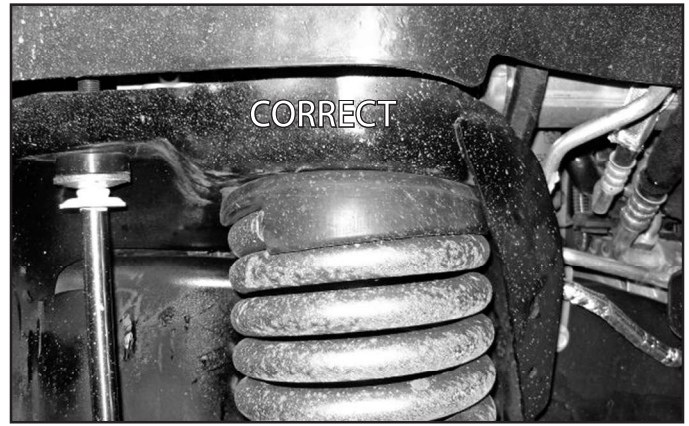

FIGURE 16C



FIGURE 16D



33. Grease and install bushings and sleeves into the shocks. Install new shocks with cup washers, bushings, and ½" nut at the top mount. Tighten the nut until the bushings begin to swell.
34. Attach the lower shock with factory hardware. Tighten hardware to 65 ft-lbs.
35. Disassemble the drag link. Trim the tab from the tie rod end flush with the end of the threads. (Fig. 17A, 17B). Trim the end of the tab on the drag link to 1-1/4" long (Fig. 17c).

FIGURE 17A

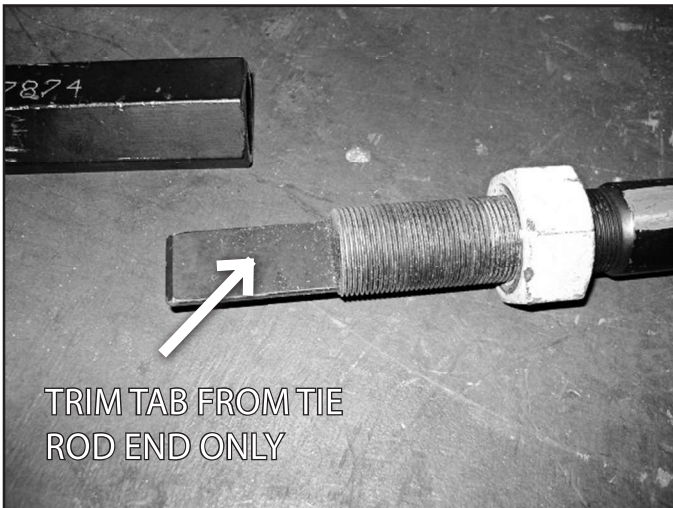
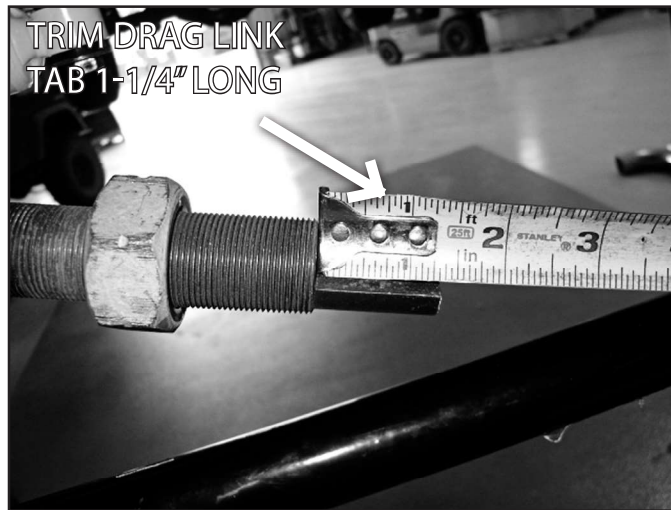

FIGURE 17B



FIGURE 17C



36. Reassemble the drag link, adjust so that there is approximately $\frac{3}{4}$ "~ $\frac{7}{8}$ " of thread exposed past the jam nuts and that the tie rod end faces up. (Fig. 18A)

FIGURE 18A



37. Install new pitman arm, use alignment mark made earlier. The included pitman arm can be installed in 2 different positions. Ensure that the pitman arm is installed in the most counter clockwise position (towards the driver side) as shown in (Fig. 18B). Loctite factory nut and install with lock washer tighten nut to 225 ft-lbs.

FIGURE 18B

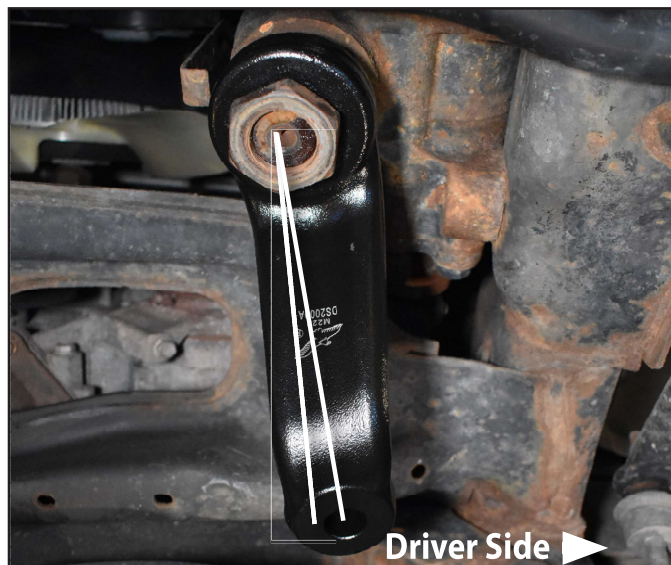

38. Attach drag link to pitman arm with factory nut. Tighten to 65 ft-lbs. (Fig. 19)

FIGURE 19

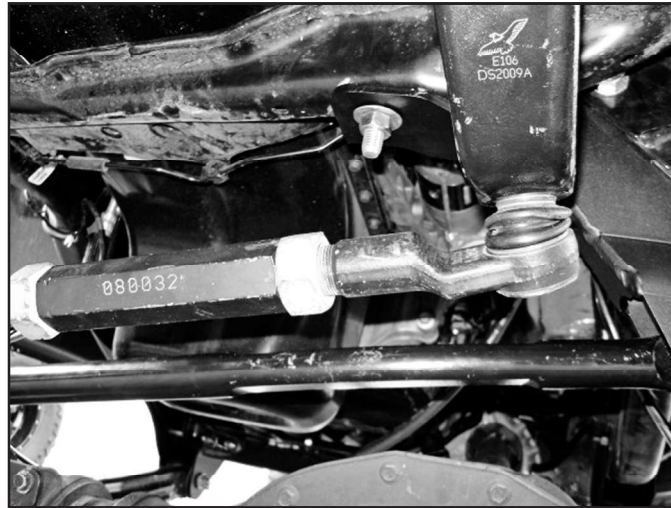

39. Attach brake line relocation brackets to the top side of the axle with the factory bolt and 5/16" self threading bolt into the original locating tab hole. The brake lines will need to have the fittings loosened so they can be rotated and pointed up. Attach the brake line to the bracket with retaining clip. The brackets will need to be offset in towards the 'inside' of the vehicle to give more clearance to the larger body of the shock. It will be necessary to slightly reform the hard line. (Fig. 20)

FIGURE 20

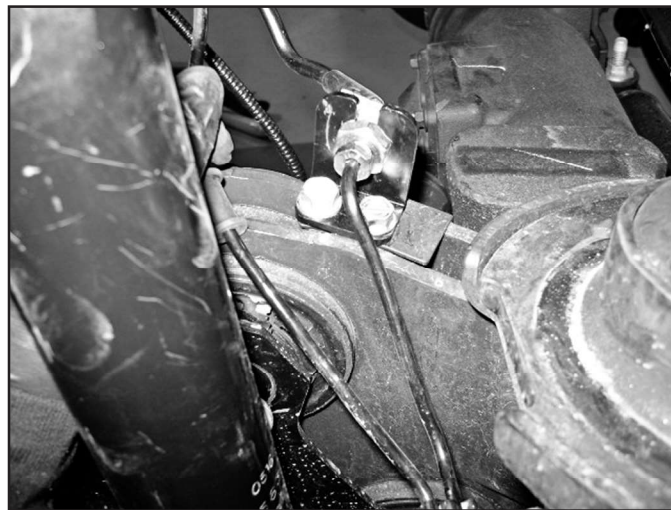

40. Install wheels and tighten lug nuts to factory specifications. Lower the vehicle to the ground.
41. Tighten radius arm hardware to 133 ft-lbs Plus 90 deg.
42. Turn the steering wheel to get the trackbar to align with the bracket. Install new 18mm bolt and tighten to 150 ft-lbs (#792).

REAR INSTALLATION - 3500 MODELS

NOTE: For Ram 2500 rear lift installation, refer to the instructions supplied in the 2500 rear box kit

43. Raise the rear of the vehicle, block the front wheels for safety. Support the frame rails with jackstands.
44. Disconnect e-brake cable and reroute the line to give adequate slack in the cable at full droop, reattach once routed for extra slack. (Fig. 21A, 21B)

FIGURE 21A



FIGURE 21B



45. Remove the factory shocks, retain all mounting hardware.
46. Support the rear axle with a hydraulic jack. Remove the u-bolts and plates from one side of the vehicle only. Loosen the u-bolts, but do not remove the opposite side.
47. Lower the axle and install new 2" lift block, with the small end of the block towards the front of the vehicle. Install new u-bolts and install the nuts, but do not tighten at this time.
48. Repeat block and u-bolt installation on opposite side of the vehicle.
49. Tighten u-bolts snugly at this time, do not torque until the vehicle is on the ground.
50. Grease bushings and sleeves, install them into both ends of the shocks. Install new shocks with factory hardware. Tighten to 65 ft-lbs. If installing optional Fox shocks, the body will be located at the frame mount.
51. 4" kits: Reattach the factory rear brakeline bracket to the top of the axle with factory hardware. Tighten to 20 ft-lbs.
52. 6" kits: Install 'L' shaped bracket to the top of the axle with factory hardware. Carefully reform the factory hard lines for adequate routing. Attach brake line bracket to 'L' bracket with 1/4" x 3/4" hardware (#768) (Fig 22a, 22b)

FIGURE 22A



FIGURE 22B

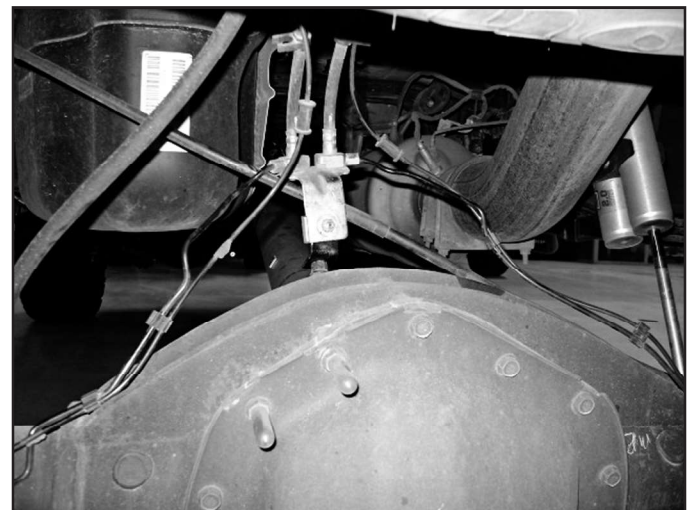

53. Reinstall wheels, torque to specification. Lower vehicle to the ground and torque u-bolts to 120 ft-lbs.

POST-INSTALLATION

1. Adjust the steering wheel to center with the collar on the drag link. Securely lock off the jam nuts once the wheel is straight. Do not drive the vehicle with the steering wheel off-center or adverse traction control problems may arise.
2. Recheck all hardware, check again at 500 miles, and again at regularly scheduled maintenance intervals. Check brake lines and ABS wires for proper clearance through steering sweep, use zip ties on the ABS wires if necessary. An alignment must now be performed.

RIVET NUT INSTALLATION INSTRUCTIONS

RIVET NUT SIZING

1. Verify the correct size rivet nut for the application based on the thickness of material where the rivet nut is to be installed using the following chart.

Part Number	Thread Size	Body Length (in)	Material Thickness (in)		Drill Size (in)
			Min.	Max.	
95105A159	3/8-16	.690	.027	.150	17/32
95105A168	3/8-16	.805	.150	.312	17/32
95105A169	1/2-13	1.150	.063	.200	11/16
95105A170	1/2-13	1.300	.200	.350	11/16

HOLE PREPARATION

2. Drill hole to appropriate size for rivet nut installation. 1/2" Rivnuts require an 11/16" hole and 3/8" Rivnuts require a 17/32" drill. It is critical that this hole is drilled to the correct size. Remove any burrs that could keep the rivet nut from seating flat against either side of the hole surface.



Tip

If the correct drill size is not available, it is possible to drill the hole to an available smaller size and slowly grind it out to until the rivet nut fits tight.

RIVET NUT INSTALLATION TOOL ASSEMBLY

3. For a 3/8" rivet nut, place the provided 3/8" SAE flat washer on the 3/8" x 1-1/2" bolt, followed by 7/16" hex nut and then a 3/8" serrated washer. (Fig. 1) Thread this tool assembly into the rivet nut.
4. For a 1/2" rivet nut, place the provided 1/2" SAE washer on a 1/2" x 2" bolt followed by a 9/16" high nut and 1/2" serrated edge lock washer. Thread this tool assembly into the rivet nut as shown. (Fig. 1)

FIGURE 1- 1/2" RIVET NUT SHOWN

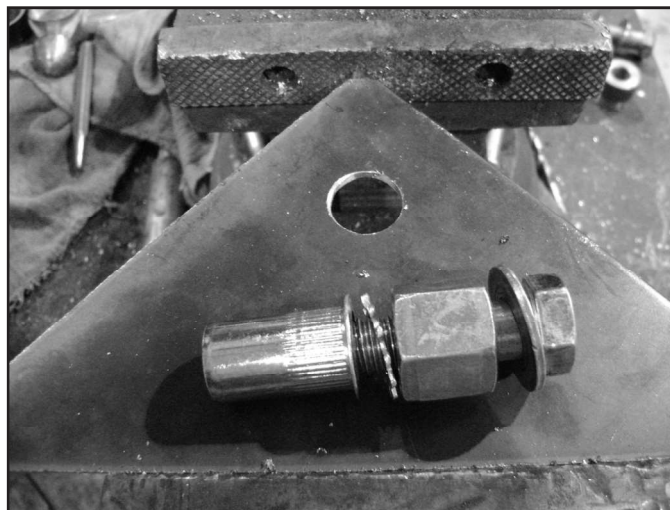

RIVET NUT INSTALLATION

5. Place the installation tool with the rivet nut threaded on the end into the appropriately sized hole.
6. For a 3/8" rivet nut, hold the nut closest to the rivet nut still with an 5/8" wrench and tighten the 3/8" bolt with a 9/16 wrench to set the rivet

nut. Be sure to hold the rivet nut flush to the surface and square to the hole as it is tightened. (Fig. 2)

 **Tip** *If available, an impact gun is recommended for tightening the bolt to ensure the rivet nut remains square to the hole and to ease holding the nut from spinning.*

7. For a 1/2" rivet nut, hold the nut closest to the rivet nut still with an 7/8" wrench and tighten the 1/2" bolt with a 3/4" wrench to set the rivet nut. Be sure to hold the rivet nut flush to the surface and square to the hole as it is tightened. (Fig. 2)

FIGURE 2 - 1/2" RIVET NUT SHOWN



TORQUE SPECIFICATIONS

8. 3/8" rivet nuts will approach 40 ft. lbs for maximum grip strength. Do not exceed 45 ft-lbs when setting the rivet nut.
9. 1/2" rivet nuts will approach 90 ft lbs for maximum grip strength. Do not exceed 100 ft-lbs when setting the rivet nut.

 **Tip** *Note: If using the recommended impact gun, use caution to not exceed the recommended torque specifications.*

RIVET NUT TOOL REMOVAL

10. Once the center bolt is tightened, remain holding the nut from spinning with the wrench and loosen the center bolt to remove the installation tool.

 **Caution** *It is very important to hold the nut as the bolt is loosened because the grip of the star washer will try to spin the rivet nut and ruin the installation.*

11. Verify proper installation by checking for consistent rivet nut deformation to see the threads are square and centered to the rivet nut. (Fig. 3)

FIGURE 3





WE WANT TO SEE YOUR RIDE!

Grab photos of your BDS-equipped truck in action and send them in for a chance to be featured. Send it in to our Bad Ass Rides customer gallery at bds-suspension.com/bar and post them on the BDS Fan Page on Facebook at facebook.com/BDSSuspensions. Don't forget about your BDS swag! BDS offers t-shirts, hoodies, decals and more available on the BDS website or through your local BDS distributor.

TIME TO HAVE SOME FUN

Thank you for choosing BDS Suspension.

For questions, technical support and warranty issues relating to this BDS Suspension product, please contact your distributor/installer before contacting BDS Suspension directly.

