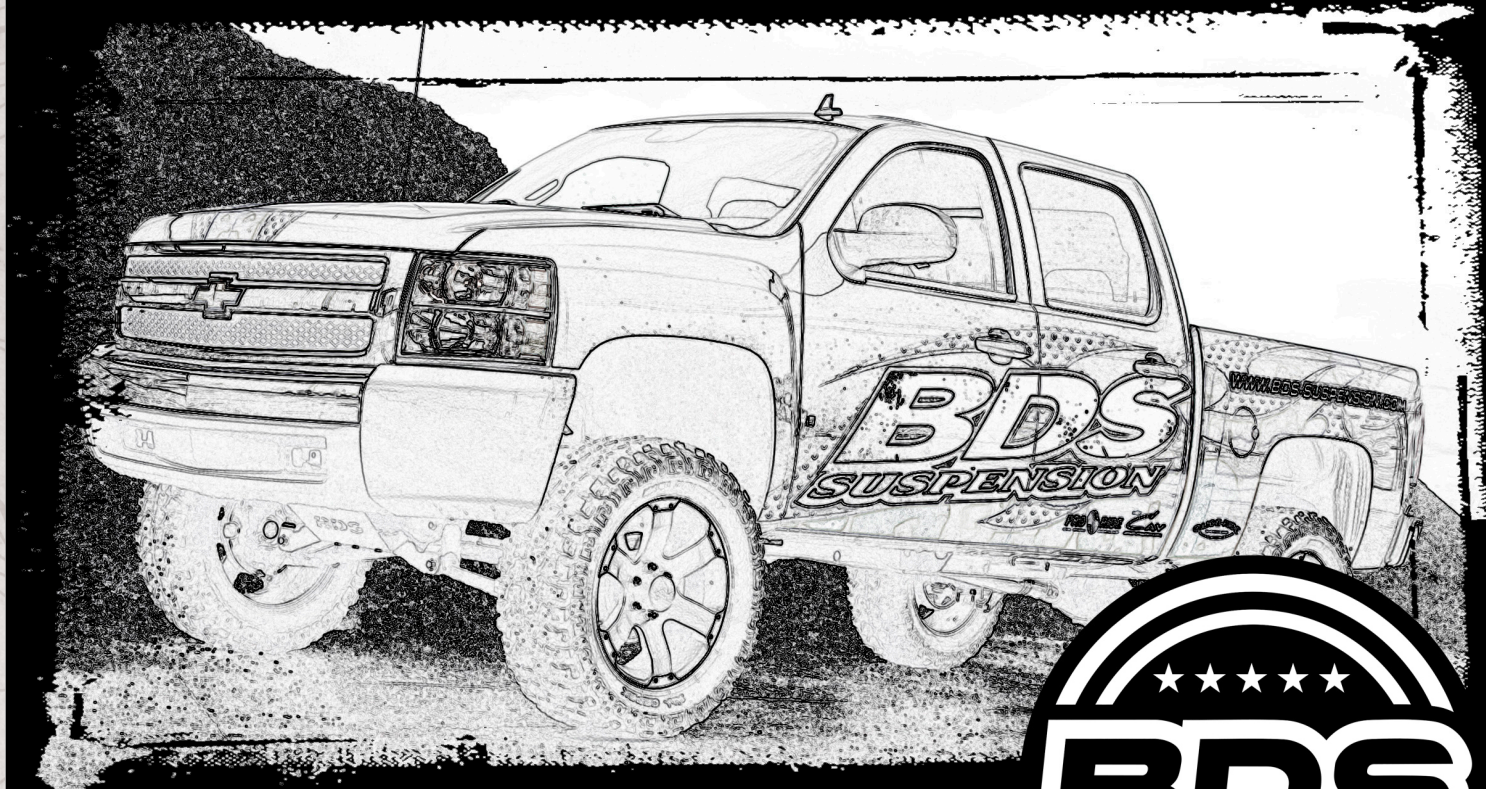


# INSTALLATION GUIDE



Part#: 021644



**HARDCORE LIMITED LIFETIME WARRANTY**

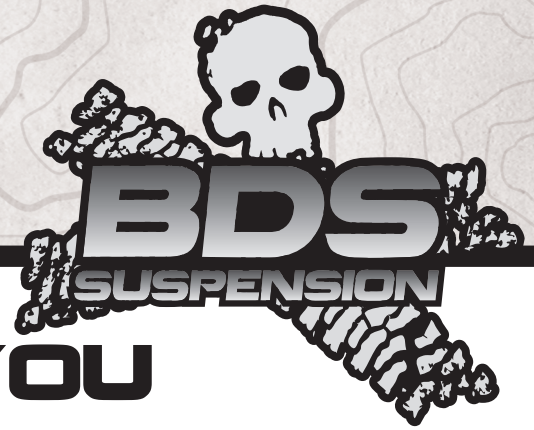
## 4" & 6" Suspension System

**Chevrolet/GMC K1500 4WD | 2007-2013**

Rev. 061317

491 W. Garfield Ave., Coldwater, MI 49036 • Phone: 517-279-2135  
E-mail: [tech-bds@ridefox.com](mailto:tech-bds@ridefox.com)

# Read And Understand All Instructions And Warnings Prior To Installation Of System And Operation Of Vehicle.



## THANK YOU

Your truck is about to be fitted with the best suspension system on the market today. That means you will be driving the baddest looking truck in the neighborhood, and you'll have the warranty to ensure that it stays that way for years to come. Thank you for choosing BDS Suspension!

### BEFORE YOU START

BDS Suspension Co. recommends this system be installed by a professional technician. In addition to these instructions, professional knowledge of disassembly/ reassembly procedures and post installation checks must be known.

### FOR YOUR SAFETY

Certain BDS Suspension products are intended to improve off-road performance. Modifying your vehicle for off-road use may result in the vehicle handling differently than a factory equipped vehicle. Extreme care must be used to prevent loss of control or vehicle rollover. Failure to drive your modified vehicle safely may result in serious injury or death. BDS Suspension Co. does not recommend the combined use of suspension lifts, body lifts, or other lifting devices. You should never operate your modified vehicle under the influence of alcohol or drugs. Always drive your modified vehicle at reduced speeds to ensure your ability to control your vehicle under all driving conditions. Always wear your seat belt.

### BEFORE INSTALLATION

Special literature required: OE Service Manual for model/year of vehicle. Refer to manual for proper disassembly/reassembly procedures of OE and related components.

Adhere to recommendations when replacement fasteners, retainers and keepers are called out in the OE manual.

Larger rim and tire combinations may increase leverage on suspension, steering, and related components. When selecting combinations larger than OE, consider the additional stress you could be inducing on the OE and related components.

Post suspension system vehicles may experience drive line vibrations. Angles may require tuning, slider on shaft may require replacement, shafts may need to be lengthened or trued, and U-joints may need to be replaced.

Secure and properly block vehicle prior to installation of BDS Suspension components. Always wear safety glasses when using power tools.

If installation is to be performed without a hoist, BDS Suspension Co. recommends rear alterations first.

Due to payload options and initial ride height variances, the amount of lift is a base figure. Final ride height dimensions may vary in accordance to original vehicle attitude. Always measure the attitude prior to beginning installation.

### BEFORE YOU DRIVE

Check all fasteners for proper torque. Check to ensure for adequate clearance between all rotating, mobile, fixed, and heated members. Verify clearance between exhaust and brake lines, fuel lines, fuel tank, floor boards and wiring harness. Check steering gear for clearance. Test and inspect brake system.

Perform steering sweep to ensure front brake hoses have adequate slack and do not contact any rotating, mobile or heated members. Inspect rear brake hoses at full extension for adequate slack. Failure to perform hose check/ replacement may result in component failure. Longer replacement hoses, if needed can be purchased from a local parts supplier.

Perform head light check and adjustment.

Re-torque all fasteners after 500 miles. Always inspect fasteners and components during routine servicing.

## TIRES AND WHEELS

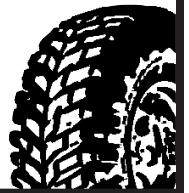
### FITMENT GUIDE

#### 6" Lift:

33x12.50 on 17x8 with 4-1/2" backspacing  
35x12.50 on 17x9 or 18x9 with 5" backspacing  
35x12.50 on 20x9 with 5.75" backspacing

#### 4" Lift:

32x11.50 on 17x8 with 4-1/2" backspacing  
33x12.50 on 17x9 or 18x9 with 5" backspacing  
33x12.50 on 20x9 with 5.75" backspacing



Visit [560plus.com](http://560plus.com) for more information.

# CONTENTS OF YOUR KIT



**TAHOE, YUKON, AVALANCHE, SUBURBAN SYSTEM**



**PICKUP SYSTEM**

## 021644 Box Kit

Part #	Qty	Description
02160	1	Steering Knuckle (drv)
02161	1	Steering Knuckle (pass)
02176	1	Front Crossmember
02177	1	Rear Crossmember
02325	1	Differential Drop Bracket (drv)
02165	1	Differential Drop Bracket (pass)
02166	2	Sway Bar Drop Bracket
98161	1	Front Strut Kit (6" Kit)
98141	1	Front Strut Kit (4" Kit)
02175	1	Differential Skid Plate
02186	1	Splash Guard
01499	2	Splash Guard Spacer
02169	1	Weld-In Plate
01165	2	CV Spacer
02115	1	Brake Line Extension (drv)
02116	1	Brake Line Extension (pass)
B56.75G2	2	5/16"-18 x 3/4" bolt
N56SS	2	5/16"-18 hex nut
LW56	2	5/16" lock washer
W56SAE	2	5/16" SAE flat washer
3396	2	Bump Stop Extension
SBLA	1	Brake Line Extension
342701	1	thread locker
099000	7	Zip Ties

## 011457 Rear Kit - Block

Part #	Qty	Description
BB088	2	5" Block
UBT4145	4	9/16" x 2-1/2" x 12-1/2" U-bolt Kit

## 021644 Box Kit

621	1	Bolt Pack (x-member hardware)
	2	5/8"-11 x 4-1/2" bolt grade 8 yellow zinc
	2	5/8"-11 x 5-1/2" bolt grade 8 yellow zinc
	4	5/8"-11 prevailing torque nut yellow zinc
	8	5/8" SAE flat washer thru-hardened yellow zinc
607	1	Bolt Pack (front main)
	4	1/2"-13 x 1-1/4" bolt grade 8 yellow zinc
	4	1/2"-13 x 1-3/4" bolt grade 8 yellow zinc
	3	1/2"-13 x 3" bolt grade 8 yellow zinc
	9	1/2"-13 prevailing torque nut yellow zinc
	18	1/2" SAE washer thru-hardened yellow zinc
	2	1-3/8"OD x 1/2"ID x 3/16" thk flat washer clear zinc
	4	10mm-1.50 x 130mm bolt class 10.9 clear zinc
	12	10mm-1.5 x 70mm bolt grade 10.9 clear zinc
	16	10mm flat washer clear zinc
	4	Wire Clip (Fastenal #0708762)
	2	1/4"-20 x 3/4" bolt grade 5 clear zinc
	2	1/4" split lock washer clear zinc
	2	1/4" SAE washer clear zinc
628	1	Bolt Pack (rear kit)
	1	5/16" x 1 bolt grade 5 clear zinc
	1	5/16"-18 prevailing torque nut clear zinc
	2	5/16" SAE flat washer clear zinc
	2	10mm-1.50 x 110mm Allen head bolt black oxide

## 011559 Rear Block and Add-A-Leaf

Part #	Qty	Description
111209R	2	Add-A-Leaf
069409	2	4" Block
228003	1	3/8" Center Pin Kit
UBT4045	4	9/16" x 2-1/2" x 11-3/8" U-bolt Kit

### 011458 - Rear Kit - Replacement Spring

Part #	Qty	Description
001559	2	Rear Spring
UBT4036	4	9/16" x 2-1/2" x 8-3/4" U-bolt Kit
071007	2	Spring Bushing Kit

### 011558 Rear Kit Replacement Spring

Part #	Qty	Description
001559	2	Rear Spring
UBT4037	4	9/16" x 2-1/2" x 10" U-bolt Kit
071007	2	Spring Bushing Kit

## TROUBLESHOOTING INFORMATION FOR YOUR VEHICLE

1. Will not fit 2007 classic models.
2. Requires frame bracket modification and minor welding.
3. 20" wheels with 5-3/4" backspacing recommended to reduce trimming.
4. AWD models may require front driveline modification.
5. Will not fit two mode hybrid models with electronic power steering.
6. Will not work with auto-ride equipped vehicles.

**TECH  
TIPS**

## INSTALLATION INSTRUCTIONS

### FRONT INSTALLATION

1. Park the vehicle on a clean, flat surface and block the rear wheels for safety.
2. Disconnect the positive and negative battery cables from the battery.
3. Raise the front of the vehicle with a hydraulic jack and support the frame with jack stands just behind the rear lower control arm pocket.
4. Remove the wheels.
5. Disconnect the ABS line from the connector on the frame (Fig 1). Remove the ABS line from the retaining clips at the frame, upper control arm and knuckle.
6. Disconnect the brake line bracket from the upper control arm (Fig 1). Retain bolt.

### SPECIAL TOOLS

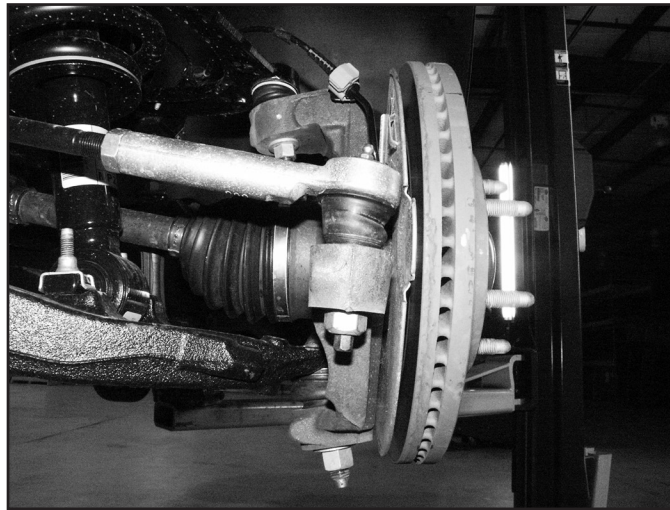
High Quality Strut Compressor  
Welder

**FIGURE 1**



7. Disconnect the steering from the knuckle (Fig 2). Remove the tie rod end nut. Strike the knuckle near the tie rod end with a hammer to dislodge it. Retain the mounting nut.

**FIGURE 2**



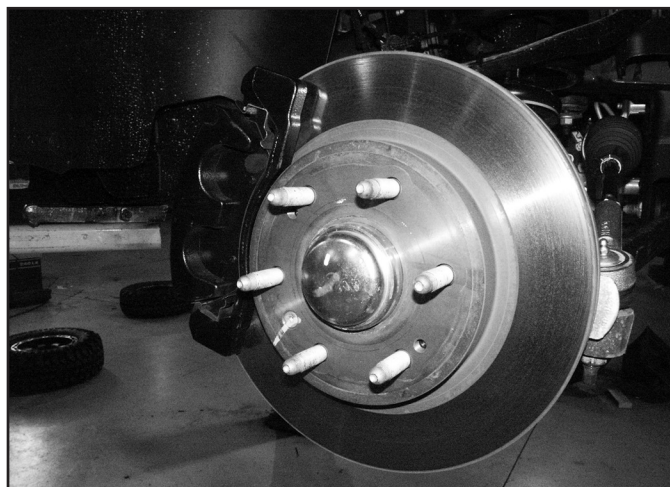
8. Remove the two brake caliper mount bolts and remove the caliper assembly from the knuckle (Fig 3). Hang the caliper securely out of the way. DO NOT hang the caliper by the brake hose.

**FIGURE 3**



9. Remove the hub dust cap (Fig 4). Remove the axle shaft nut. Retain nut and cap. Remove brake rotor.

**FIGURE 4**



10. Remove the sway bar links from the sway bar and the lower control arm (Fig 5). Retain the links, bushings and hardware.

**FIGURE 5**



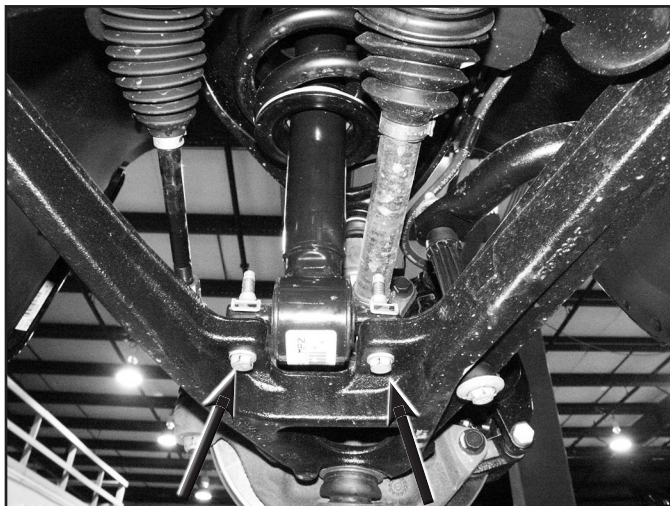
11. Remove the sway bar from the frame by removing the four bushing cap mounting bolts (Fig 6). Retain all sway bar components.

**FIGURE 6**



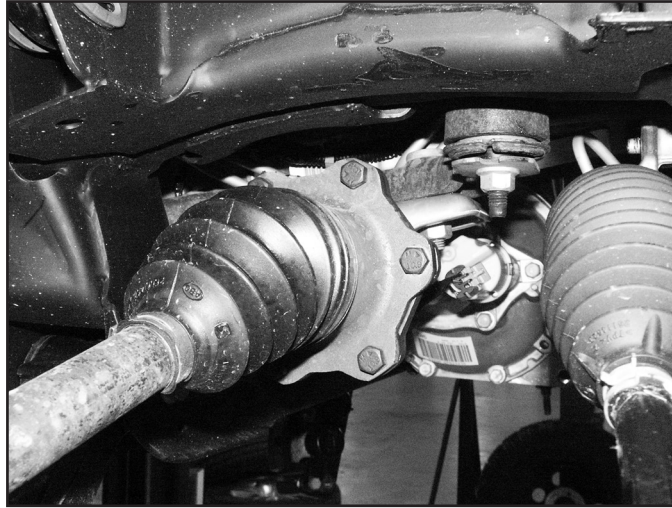
12. Mark each of the front strut bodies to indicate driver's versus passenger's side. Make the marks on the side of the strut that is facing out.
13. Support the lower control arm with a jack. Remove the lower strut mount bolts (Fig 7). Retain bolts.

**FIGURE 7**



14. Remove the CV shaft mounting flange nuts (Fig 8). Mark the shaft to indicate driver's or passenger's side. Discard bolts.

**FIGURE 8**



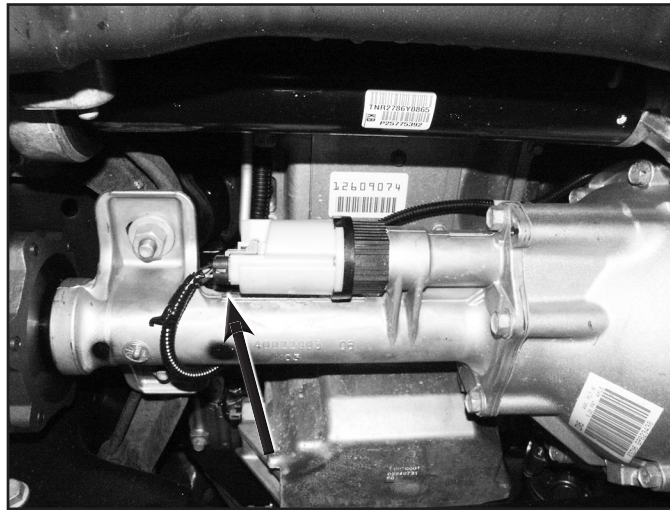
15. Remove the upper and lower ball joint nuts and thread back on by hand a couple of turns. Strike the knuckle near the upper and lower ball joints to dislodge them from the knuckle. Remove the upper ball joint nut and lower the lower control arm down. Remove the CV shaft from the hub and set aside. Remove the lower ball joint nut and remove the knuckle assembly from the lower control arm.
16. Remove the front and rear lower control arm mounting bolts and remove the lower control arm from the vehicle. Retain mounting hardware.
17. Remove the three upper strut mounting nuts (Fig 9) and remove the strut from the vehicle. DO NOT remove the center strut rod nut, it is under extreme pressure. Retain nuts.

**FIGURE 9**



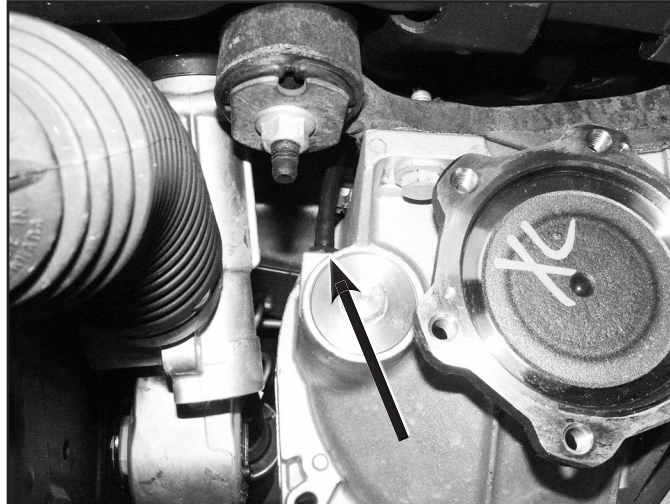
18. Disconnect the differential actuator wire connector from the actuator (Fig 10). Remove the three wire harness clips holding the actuator harness to the differential housing.

**FIGURE 10**



19. Disconnect the differential breather hose (Fig 11).

**FIGURE 11**



20. Make an alignment mark to show the relationship between the front driveshaft and the differential input flange. Remove the four drive-shaft bolts and disconnect the driveshaft from the differential. Retain bolts.
21. Remove the four bolts and the OE rear control arm pocket crossmember from the vehicle (Fig 12). Retain bolts.

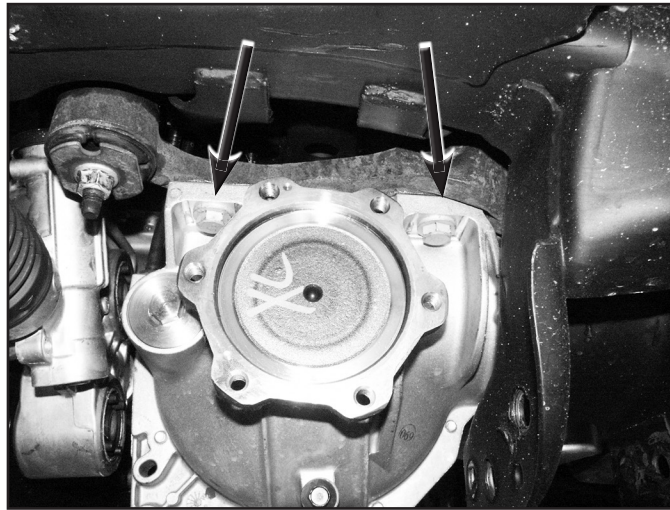
**FIGURE 12**





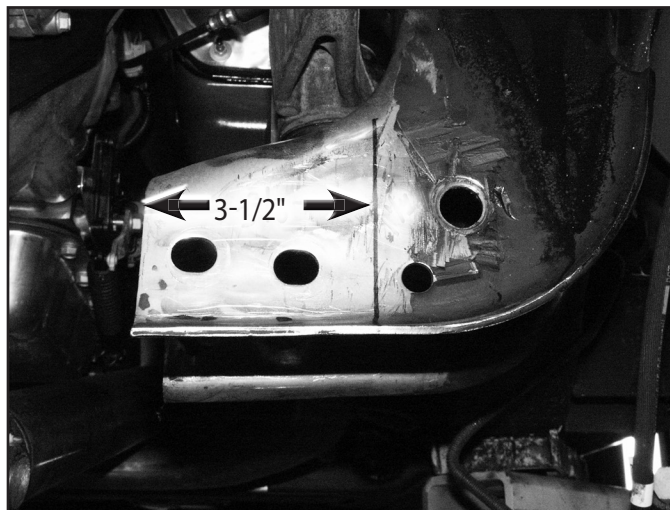
22. Support the front differential with an appropriate jack. Remove the two driver's side differential mounting nuts (Fig 13) and the passenger's side mounting bolts. Carefully lower the differential to the ground. Retain mounting hardware.

**FIGURE 13**



23. The driver's side rear lower control arm pocket must be cut to provide clearance for the front differential in the relocated position. The entire area needs to be cleaned of any oil, grease and/or undercoating. These coatings are flammable.
24. Measure from the inside of the driver's side control arm pocket out 3-1/2" and mark. Repeat this measurement on the opposite side of the pocket. Make vertical cut lines at the 3-1/2" mark up both front and back faces of the pocket. (Fig 14).

**FIGURE 14**



25. Make a vertical cut along each of the cut lines on the front and back faces of the control arm pocket with a reciprocating saw (recommended), cut-off wheel or plasma cutter. Be careful, the undercoating on the frame is flammable and can melt and drip off the frame. Keep an appropriate fire extinguisher near by.
26. With the vertical cuts complete, cut the top portion of the pocket by connecting the two cuts (Fig 15).

**FIGURE 15**



27. Place the provided weld-in plate (02169) up against the cut edge of the control arm pocket. The plate should be flush with the bottom edge of the pocket and overhang the front and back outside surfaces an equal amount (Fig 16). Tack weld the plate in place.



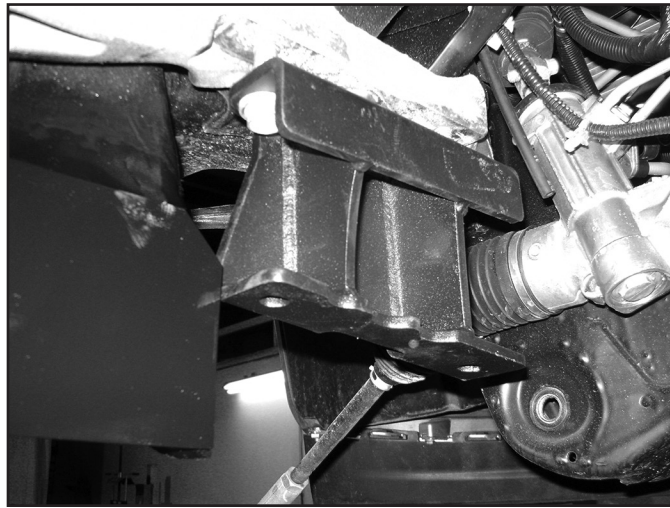
**Tip** *Welding should be performed by a certified welder.*

**FIGURE 16**



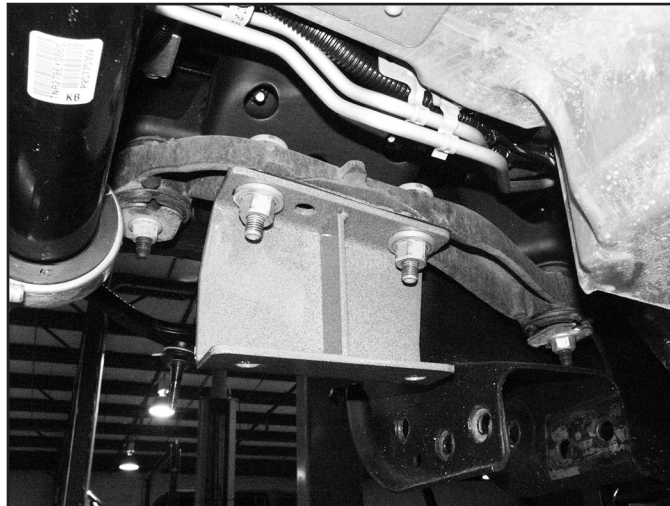
28. With the plate tacked, go back and weld the plate in place. Weld along the OUTSIDE of the pocket on the vertical surfaces. Welding on the inside will result in crossmember interference. Weld all the top edge of the plate on the inside of the pocket. Once the area has cooled, paint all exposed metal to prevent corrosion.
29. Install the new driver's side differential bracket (02325) to the OE mount with the factory bolts (Fig 17). The bracket surface with 3 holes in it goes to the OE mount and the open face points toward the inside of the vehicle. Torque bolts to 65 ft-lbs.

**FIGURE 17**



30. Install the new passenger's side differential bracket (02165) to the OE mounting studs with the factory nuts (Fig 18). The bracket mounting surface with 3 holes in it goes to the frame and the open face toward the inside of the vehicle. Torque nuts to 65 ft-lbs.

**FIGURE 18**

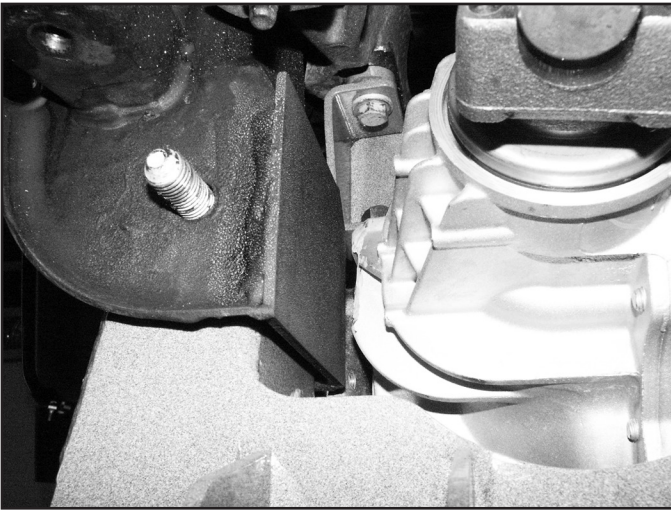


31. Using an appropriate jack, install the differential in the vehicle by attaching it to the new driver's and passenger's differential brackets. Fasten the differential to the brackets with  $\frac{1}{2}$ " x 1-3/4" bolts, nuts and washers (BP 607). Use two  $\frac{1}{2}$ " SAE washers on each bolt for the driver's side. Use one  $\frac{1}{2}$ " SAE washer and one extra large  $\frac{1}{2}$ " washer on the passenger's side. The extra large washer will go against the differential housing flange with the large slots. Torque the  $\frac{1}{2}$ " hardware to 65 ft-lbs. Pull the differential forward as the passenger's side bolts are tightened.

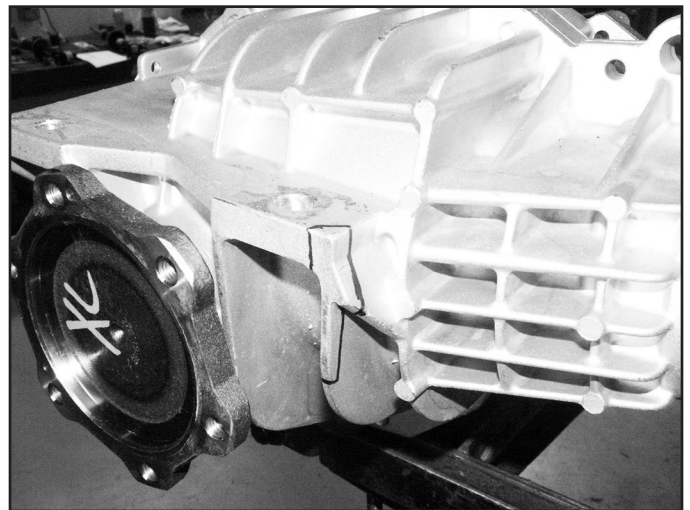


**Tip** *If the differential is hitting the weld-in plate when installed as a result of plate placement (Fig 19), remove the differential and grind the corner of the differential housing for clearance. Only about 3/8" of material needs to be removed (Fig 20).*

**FIGURE 19**

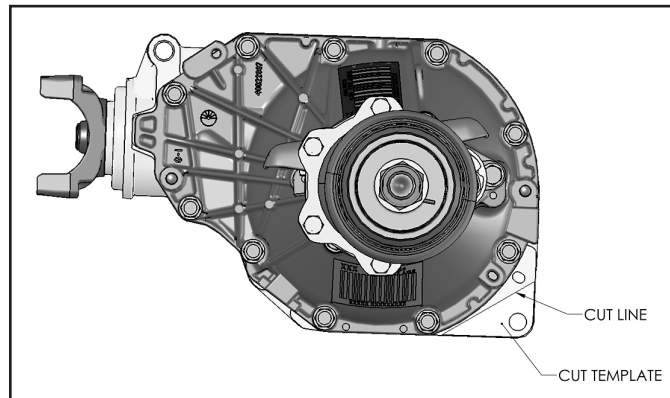


**FIGURE 20**



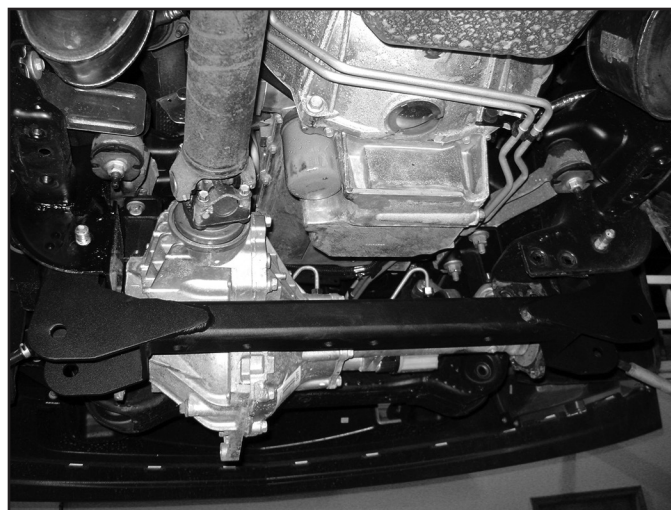
32. Reconnect the differential actuator wiring. Reattach the wire to the differential housing with the provided wire ties.
33. Reconnect the differential breather line. The line will need to be removed from retaining clips above to gain slack.
34. Reconnect the front drive shaft to the differential with the original hardware. Torque bolts to 19 ft-lbs.
35. The front lower tab protruding from the differential must be trimmed off to allow for clearance of the differential skid plate to be installed later (Fig 21). Cut out the provided tab cut template at the end of the instruction sheet. Use the template to mark a cut line on the differential. Cut the tab from the differential using a reciprocating saw or hand hacksaw.

**FIGURE 21**



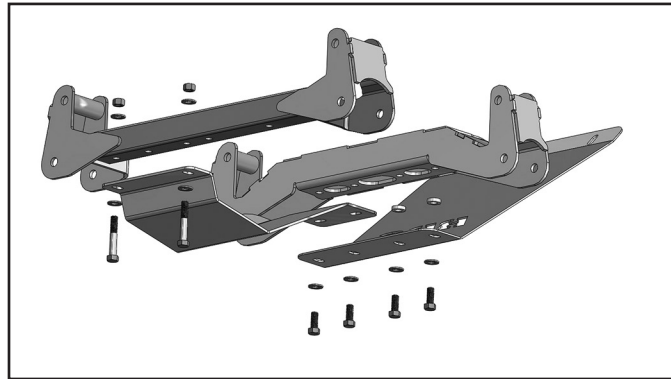
36. Install the new rear crossmember (02177) with the OE lower control arm bolts, nuts and washers. Leave hardware loose. (Fig. 22)

**FIGURE 22**



37. Remove the factory front plastic splash guard. Retain the hardware and discard the splash guard.
38. Install the front crossmember (02176) in the control arm pockets with the OE lower control arm bolts, nuts and washers. Also fasten the center of the crossmember to the frame using the two original front splash guard mounting holes and bolts. Leave hardware loose.
39. Attach the new differential skid plate (02175) to the bottom of the rear crossmember with 1/2" x 3" bolts, nuts and 1/2" SAE washers (BP 607). Run the bolts from the bottom up through the crossmember. Snug hardware enough to pull the skid plate flush with the crossmember but loose enough to adjust the position.
40. Install the new BDS front splash guard to the factory front upper frame crossmember tube. Loosely fasten the splash guard with the original splash guard bolts.
41. Swing the bottom end of the splash guard up to the new front crossmember. The splash guard will "sandwich" the differential skid plate between itself and the front crossmember (Fig 23). Place the provided 1/4" thick spacer washers (01499) between the splash guard and the front crossmember in the two remaining holes on the passenger's side of the crossmember. Fasten everything together with 1/2" x 1-1/4" bolts, nuts and 1/2" SAE washers (BP 607). The two center holes have welded nuts in the crossmember which will not require a nut and second washer. Leave hardware loose.

**FIGURE 23**



42. Install the OE lower control arms in the new crossmembers and fasten with 5/8" x 4-1/2" and 5/8" x 5-1/2" bolts, nuts and 5/8" SAE washers (BP 621). Leave hardware loose.
43. With the crossmembers, control arms, skid plate and splash guard installed, go back and torque the crossmember mounting bolts to 125 ft-lbs. and OE splash guard bolts to 20 ft-lbs. (for splash guard and front crossmember). Torque the 1/2" skid plate hardware to 65 ft-lbs.
44. Fox Coilover: See end of instruction sheet for specific installation details.
45. Place indexing marks on the strut body, strut cap and upper coil seat for reference when the new strut is reassembled.

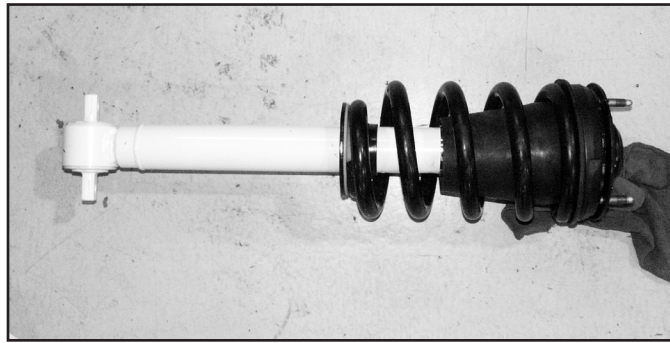
**! Caution** *Coil spring is under extreme pressure. Improper removal/installation of coil spring could result in serious injury or death. Use only a high-quality spring compressor and carefully read and follow the manufacturer's instructions.*

46. Using an appropriate strut compressor, compress the coil spring and remove the upper strut nut. Remove the strut from the coil spring.
47. Remove the factory bump stop for the OE strut rod and install it on the new provided strut. Apply grease to the ID of the bump stop to ease installation.
48. Install the new strut, orienting it the same as the OE one, in the coil spring. Fasten the strut with the new provided nut. Pay close attention to the lower mounting bar pin as it is not angled perpendicular to the strut body. This bar pin must be oriented correctly to mate to the lower control arm properly (Fig 24). Torque the strut nut to 22 ft-lbs. Do not overtighten the strut stem.



**Tip** *The struts are shipped collapsed. Rotate the strut rod counter-clockwise to allow it to extend.*

**FIGURE 24**



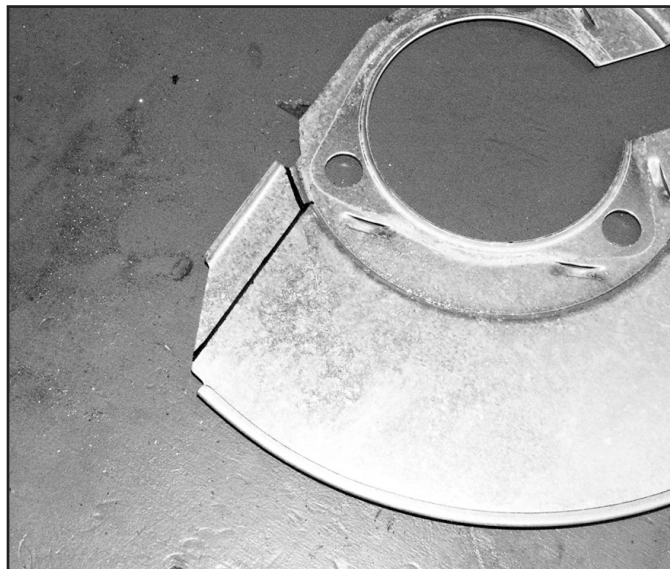
49. Locate the two captive nuts on the OE strut bar pin. Carefully remove these nuts and transfer them to the new strut.
50. Install the new strut assembly to the appropriate frame mount with the original nuts. Torque the nuts to 40 ft-lbs.



**Tip** *Be sure that the strut is oriented properly in the vehicle.*

51. Swing the lower control arm up to the strut and fasten it with the original mounting bolts. Torque bolts to 40 ft-lbs.
52. Remove the hub bearing/rotor assembly and brake dust shield from the OE steering knuckles. Be sure to note which hub goes on which side of the vehicle. Retain mounting bolts.
53. The brake dust shield needs to be trimmed. Measure in from the lower vertical edge (opposite the ABS sensor location)  $\frac{3}{4}$ " and make a vertical cut line along the entire flat section (Fig 25). Cut the mark section off of the brake dust shield.

**FIGURE 25**



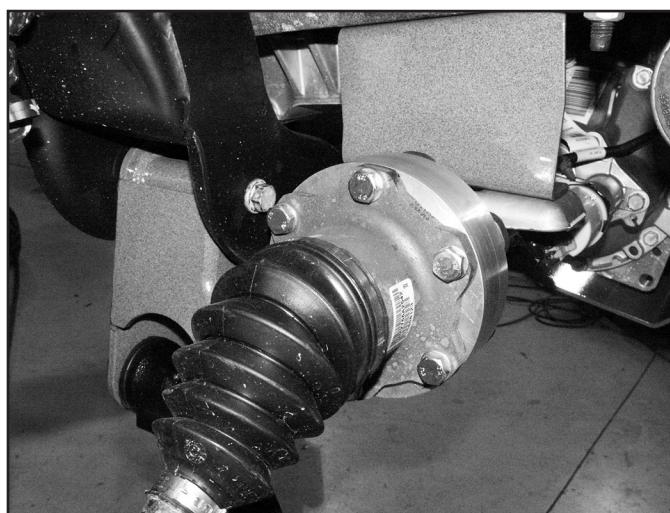
54. Install the modified dust shield and hub/rotor in the corresponding new knuckles. Fasten the hub/shield with the OE bolts. Apply thread locker to the bolt threads and torque to 133 ft-lbs.
55. Install the assembled knuckle on the lower control arm with the original lower control arm nut. Install the CV shaft in the hub and then attach the knuckle to the upper control arm with the original upper ball joint nut. Torque the upper ball joint nut to 37 ft-lbs and the lower ball joint nut to 74 ft-lbs (Fig 26).

**FIGURE 26**



56. Position the provided CV spacer (01165) between the CV shaft and the differential mounting flange (Fig 27). Fasten the CV and spacer to the differential flange with 10mm x 70mm bolts and 10mm washers (BP 607). Use thread locker on the bolt threads and torque to 45 ft-lbs using a crossing pattern.

**FIGURE 27**

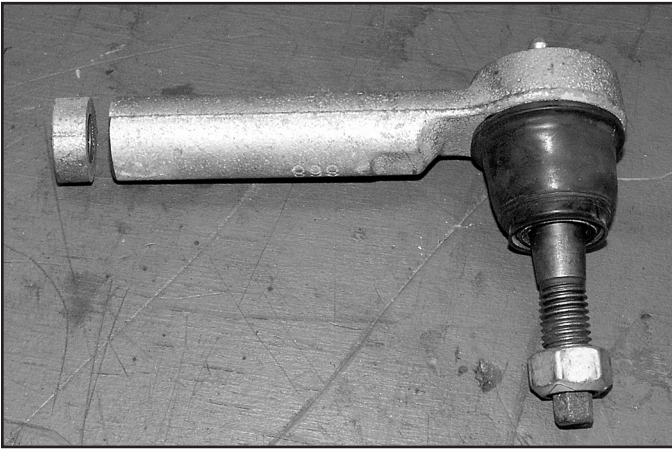


57. Reinstall the original CV axle nut and torque to 155 ft-lbs.
58. Working on one side at a time, remove the tie rod end from the steering link (Fig 28). Trim 1/2~9/16" off of both the tie rod end and the steering link. (Fig 29A,29B) This will allow for proper alignment adjustment once the kit is complete. Once the two pieces are trimmed, clean the ends of the threads and reinstall the tie rod end on the steering link. Repeat on other side of the vehicle.

**FIGURE 28**



**FIGURE 29A**



**FIGURE 29B**



59. Disconnect the OE rubber brake line from the hard line at the frame. Remove the retaining clip and remove the brake line from the bracket. Disconnect the bracket from the frame. Retain hardware.
60. Attach the caliper to the new steering knuckle with the original mounting hardware. Torque bolts to 125 ft-lbs.
61. Carefully remove the metal retainer bracket from the OE rubber brake line.

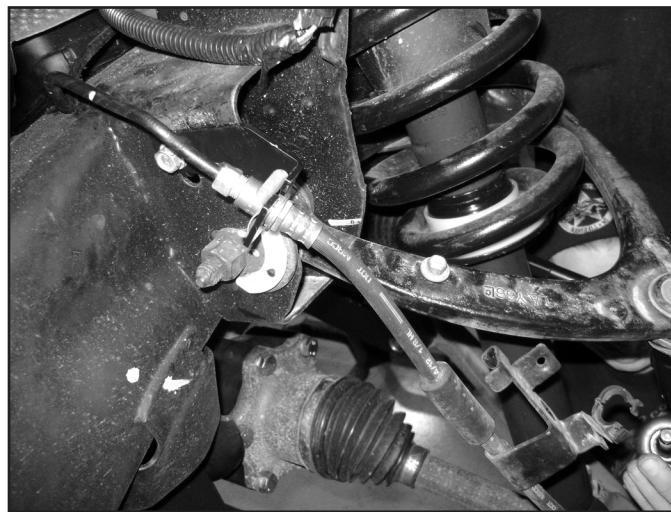


**Tip**

*It may be easier to remove the brake line from the bracket by removing it from the vehicle completely and holding the bracket in a bench vise.*

62. Align the tab in the provided brake line bracket to the upper control arm mount and attach the bracket using the original mounting hole and OE bolt (Fig. 30) Torque the brake line bracket to 20 ft-lbs.

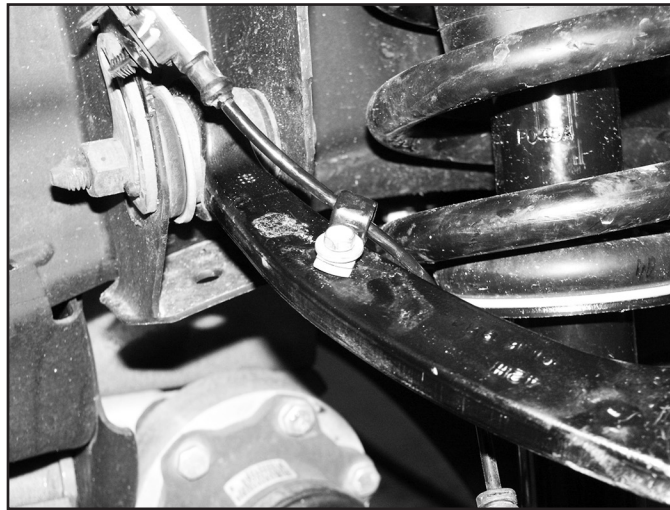
**FIGURE 30**



63. Carefully reform the brake hard line down near the new bracket. Run the end of the rubber brake hose through the bracket and attach it to the hard line. Tighten the fitting securely. Retain the brake line to the bracket with the original clip.
64. Attach the ABS line to the upper control arm (Fig 31) with the original brake line mounting bolt and provided wire clamp (BP 607).



**FIGURE 31**



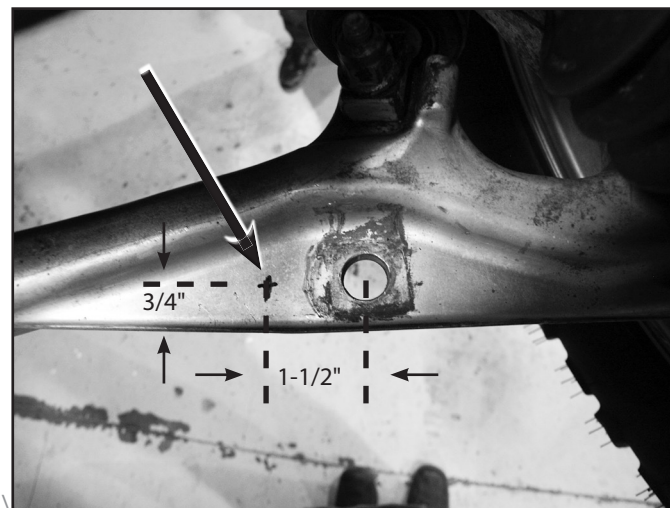
65. Reconnect ABS line at the frame. Attach the ABS line to the steering knuckle with the provided wire clamps and  $\frac{1}{4}$ " x  $\frac{3}{4}$ " bolt, flat washer and lock washer (BP 641). Torque bolt to 15 ft-lbs. Use zip ties to retain the remaining section of the ABS line as needed to keep it away from rotating objects (Fig 32).

**FIGURE 32**



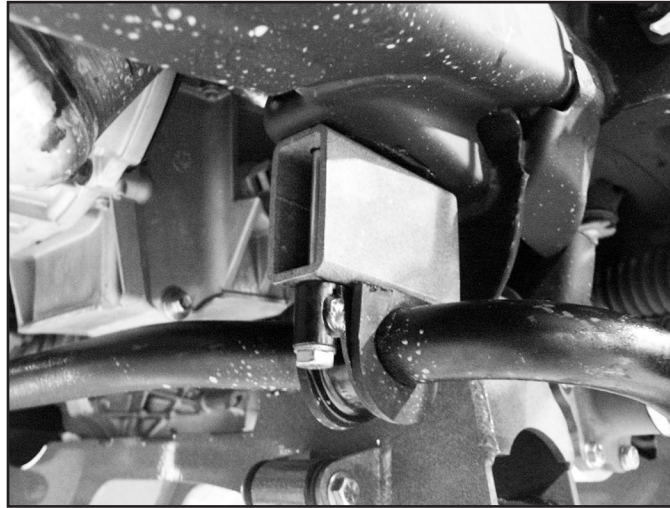
66. Locate the original sway bar link mounting hole on the lower control arm. Measure inward from the center on the hole  $1\frac{1}{2}$ " (toward the frame mount) and mark. Measure in from the back edge of the control near the first mark  $\frac{3}{4}$ " and mark. Where the two marks cross drill a  $\frac{5}{8}$ " hole (Fig 33).

**FIGURE 33**



67. Attach the OE front sway bar to the original mounts in conjunction with the provided drop brackets (02166) and 10mm x 130mm bolts/washers (BP 641). Use thread locker on the bolt threads and torque to 45 ft-lbs (Fig 34).

**FIGURE 34**



68. Attach the original sway bar links and hardware to the sway bar end and new hole in the lower control arm (Fig 35). Tighten the sway bar link until the bushings begin to swell.

**FIGURE 35**

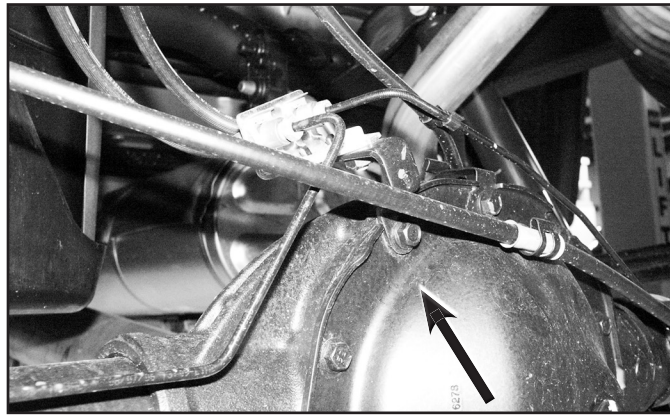


69. Install the wheels/tires and lower the front of the vehicle to the ground.  
70. Bounce the front of the vehicle to settle the suspension. Torque the lower control arm mounting bolts to 150 ft-lbs.  
71. Check all hardware for proper torque.  
72. Bleed the entire brake system. See service manual for proper brake system bleeding procedures.  
73. Reconnect the battery cables to the battery.

## **REAR INSTALLATION**

1. Safely raise the rear of the vehicle and support with jack stands just ahead of the front leaf spring frame mount.
2. Remove the tires and wheels.
3. Support the rear axle with a floor jack.
4. Remove the OE shock absorbers. Retain hardware.
5. Disconnect the rear brake line bracket from the top of the differential (Fig 36). Retain hardware.

**FIGURE 36**



6. Remove the ABS lines from the retaining clip on the bottom of each frame rail. Also disconnect the ABS line connector from the top of the frame rail (Fig 37).
7. Remove the driver's side parking brake cable from the rear-most retaining bracket on the driver's side frame rail (Fig 38).

**FIGURE 37**



**FIGURE 38**



## ADD-A-LEAF/BLOCK INSTALLATION

Complete the following steps one side at a time. If installing a 4" rear kit (#011457) disregard the add-a-leaf installation (steps 9 thru 14).

8. With the rear axle well supported, remove the leaf spring U-bolts. Discard the u-bolts, nuts and washers.
9. Use C-clamps to hold the spring assembly securely together about 6" away from the center pin (two clamps).
10. Remove the leaf spring center pin and slowly remove the C-clamps.
11. Place the add-a-leaf (111209) between the second and third leaves.
12. Slide the provided 3/8" pin up through the leaf pack and start the nut to hold the pack together.
13. Do not use the center pin to draw the leaf pack together. Use a C-clamp on each side of the center pin to draw the pack together while ensuring that the leaves are in line. After the pack is drawn together, Torque the center pin to 30 ft-lbs.
14. Remove the C-clamps. Cut off any excess center pin.
15. Remove the OE block (if equipped). Position the new block (6" Kit: 4KB-W96, 4" Kit: BB088) between the spring pack and the spring perch. 6" Kit Only - Make sure that the thick side of the block is toward the rear of the vehicle (tapers down toward the front of the vehicle).
16. Slowly raise the floor jack under the axle while aligning the pin in the leaf pack with the hole in the block. Align the pin in the block with the OE spring pad.
17. Install two new U-bolts over the OE spring plate, spring pack, block, and axle tube. From the under side of the axle tube, place the OE lower U-bolt plate over the U-bolts and hold the assembly together with the 9/16" high nuts and washers. Snug u-bolts. Final u-bolt torque is done with the weight of the vehicle on the springs.
18. Repeat add-a-leaf/block installation for other side of vehicle.

## REAR LEAF SPRING INSTALLATION

Complete the following steps one side at a time.

19. With the rear axle well supported, remove the leaf spring U-bolts. Discard the u-bolts, nuts and washers.
20. Lower the axle from the leaf spring. For 6" kits, leave the OE block on the axle, it will be reused with the new spring. For 4" kits, remove the OE block, it will not be reused.
21. Remove the rear spring shackle to frame bolt as well as the front spring hanger to spring bolt. Remove the leaf spring assembly from the vehicle.



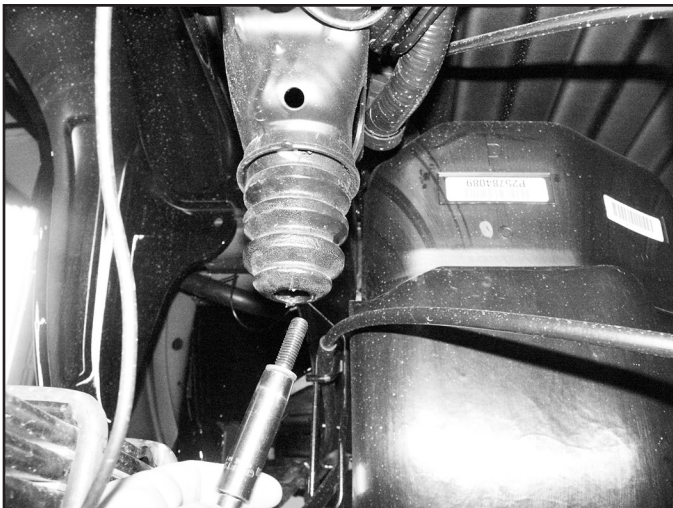
**Tip** *On the driver's side it may be necessary to loosen the fuel tank retaining straps and push the tank inward to access the front spring hanger bolt. Retain hardware.*

22. Lightly grease and install the provided bushings (3521RB) and sleeves (30) in the leaf spring eyes.
23. Remove the shackle from the OE spring and transfer it to the new spring (001559) with the factory hardware. The shackle will go on the end opposite of where the "001559" is painted. Leave shackle hardware loose.
24. Install the new spring assembly in the vehicle with the OE hardware. Be sure that the shim on the bottom of the leaf pack tapers down as it goes toward the front of the vehicle. Leave hardware loose.
25. Raise the rear axle while aligning the center pin in the leaf spring with the center pin hole in the OE block. Install two new U-bolts over the OE spring plate, spring pack, block, and axle tube. From the under side of the axle tube, place the OE lower U-bolt plate over the U-bolts and hold the assembly together with the 9/16" high nuts and washers. Snug u-bolts. Final u-bolt torque is done with the weight of the vehicle on the springs.
26. Repeat the leaf spring installation on the other side of the vehicle.

## BOTH KIT OPTIONS

27. Remove the rear rubber bump stops from the frame (Fig 39). Access the bolt head up through the center of bump stop. Install the spacer (3396) between the bump stop and the frame mount with a 10mm x 110mm Allen head bolt (thread locker threads). Center the spacer on the lip of the OE bump stop cup and torque bolt to 35 ft-lbs (Fig 40).

**FIGURE 39**

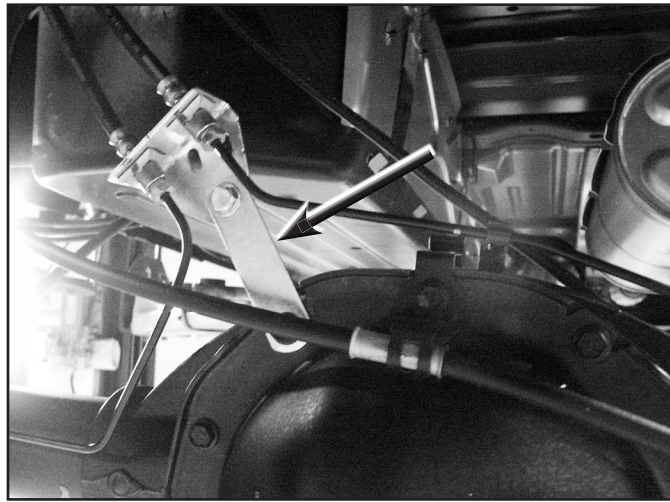


**FIGURE 40**



28. Install BDS shocks with stock hardware and torque upper and lower bolts to 65 ft-lbs. The axle mounting tabs may need to be bent open slightly to allow for clearance of the larger diameter shocks. Also, check the clearance between the shock body and the brake line bolt (drv's side), this bolt may need to be trimmed. Use the provided washers to properly preload the shock bushings.
29. Install the provided brake line bracket (SBLA) to the top of the differential using OE mounting hole and hardware. Attach the OE brake line bracket to the relocation bracket with a 5/16" x 1" bolt, nut and washers (BP 628). Torque the OE and 5/16" bolt to 20 ft-lbs (Fig 41).

**FIGURE 41**



30. Reconnect the ABS lines to the plastic retaining clip at the bottom of each frame rail. The connector will not be reattached to the top of the frame. Reroute the lines as necessary to gain proper slack.
31. Install wheels and tires. Torque lug nuts to manufacturer's specifications. Lower vehicle.
32. Bounce the rear of the vehicle to settle the suspension. Torque leaf spring u-bolts to 100-120 ft-lbs. If new springs were installed, torque the shackle and hanger bolts to 70 ft-lbs.

## **FOX COIL-OVER INSTALLATION ADDENDUM**

1. The coil-overs are installed with the reservoir hose at the rear of the vehicle. Determine the appropriate coil-over for each side.
2. Loosely attach the coil-over to the upper mount using the two inner most upper mounting bolts with washers.
3. Locate the reservoir mount and position it on top of the strut tower so it faces out and the mounting hole lines up with the 3rd coil-over mounting hole. Install the 3rd coil-over mounting bolt and attach the reservoir mount to the frame. Tighten the upper mounting bolts to 40 ft-lbs.
4. Install the reservoir to the bracket with the provided clamps with the reservoir centered in the bracket. (Fig. 45a / 45b) Slide the reservoir all the way 'forward' on the vehicle for reservoir hose to upper control arm clearance. Cycle upper arm to ensure clearance.

**FIGURE 42A**



**FIGURE 42B**



5. Swing the lower control arm up to the lower coil-over mount, apply thread locker, and fasten with the provided bolts. Torque lower hardware to 40 ft-lbs.
6. Continue with the installation where you left off in the main instructions.

## POST INSTALLATION

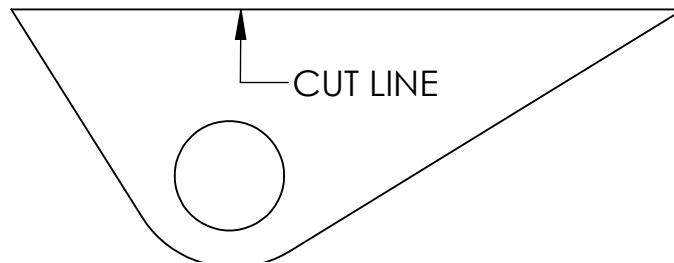
1. Double check all fasteners for proper torque.
2. Check all moving parts for clearance.
3. Complete a full radius turning check to ensure that no interference occurs.
4. Align headlights
5. Double check the brake lines for adequate slack at full wheel travel.
6. Complete a vehicle alignment.
7. Check all fasteners after 500 miles.



**Tip**

*Installation of larger tires may require speedometer adjustment.*

## FRONT DIFFERENTIAL TAB CUT TEMPLATE



### **WE WANT TO SEE YOUR RIDE!**

Grab photos of your BDS-equipped truck in action and send them in for a chance to be featured. Send it in to our Bad Ass Rides customer gallery at [bds-suspension.com/bar](http://bds-suspension.com/bar) and post them on the BDS Fan Page on Facebook at [facebook.com/BDSSuspensions](https://facebook.com/BDSSuspensions). Don't forget about your BDS swag! BDS offers t-shirts, hoodies, decals and more available on the BDS website or through your local BDS distributor.

---

## **TIME TO HAVE SOME FUN**

**Thank you for choosing BDS Suspension.**

For questions, technical support and warranty issues relating to this BDS Suspension product, please contact your distributor/installer before contacting BDS Suspension directly.