

INSTALLATION GUIDE

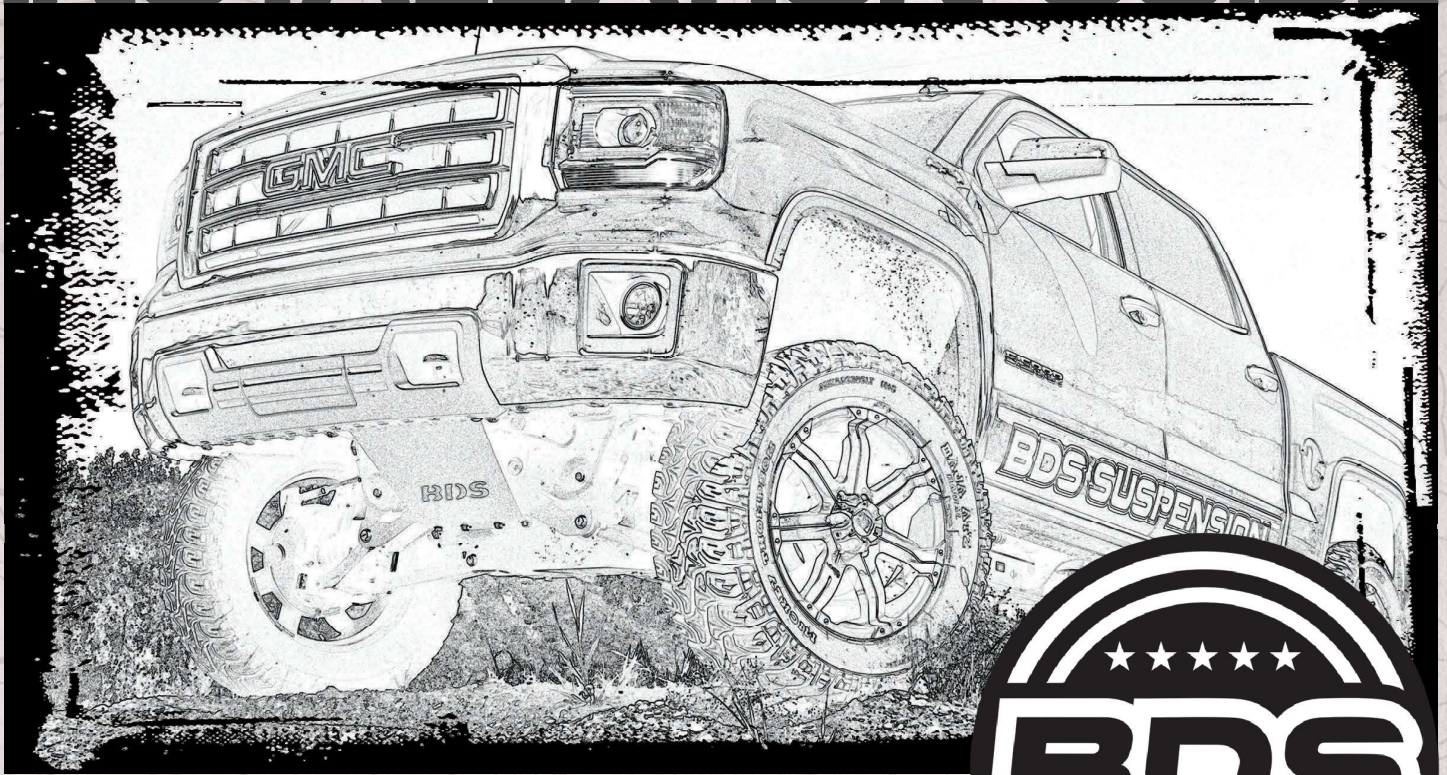

Part#: 021803



HARDCORE LIMITED LIFETIME WARRANTY

8" Suspension Systems

Chevy/GMC 1500 4WD Pickup | 2014-2018

Rev. 122920

491 W. Garfield Ave., Coldwater, MI 49036 • Phone: 517-279-2135
E-mail: tech-bds@ridefox.com

Read And Understand All Instructions And Warnings Prior To Installation Of System And Operation Of Vehicle.

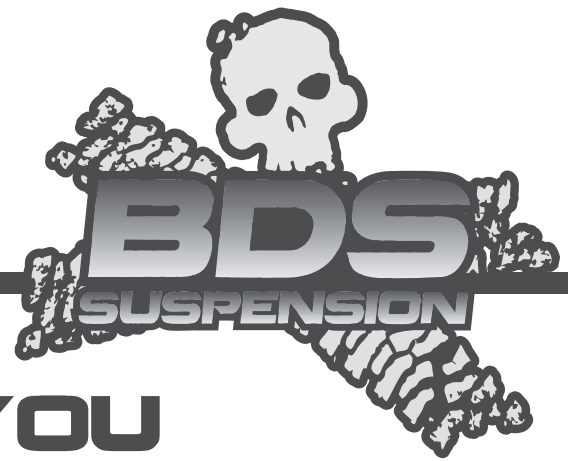

THANK YOU

Your truck is about to be fitted with the best suspension system on the market today. That means you will be driving the baddest looking truck in the neighborhood, and you'll have the warranty to ensure that it stays that way for years to come. Thank you for choosing BDS Suspension!

BEFORE YOU START

BDS Suspension Co. recommends this system be installed by a professional technician. In addition to these instructions, professional knowledge of disassembly/ reassembly procedures and post installation checks must be known.

FOR YOUR SAFETY

Certain BDS Suspension products are intended to improve off-road performance. Modifying your vehicle for off-road use may result in the vehicle handling differently than a factory equipped vehicle. Extreme care must be used to prevent loss of control or vehicle rollover. Failure to drive your modified vehicle safely may result in serious injury or death. BDS Suspension Co. does not recommend the combined use of suspension lifts, body lifts, or other lifting devices. You should never operate your modified vehicle under the influence of alcohol or drugs. Always drive your modified vehicle at reduced speeds to ensure your ability to control your vehicle under all driving conditions. Always wear your seat belt.

BEFORE INSTALLATION

Special literature required: OE Service Manual for model/year of vehicle. Refer to manual for proper disassembly/reassembly procedures of OE and related components.

Adhere to recommendations when replacement fasteners, retainers and keepers are called out in the OE manual.

Larger rim and tire combinations may increase leverage on suspension, steering, and related components. When selecting combinations larger than OE, consider the additional stress you could be inducing on the OE and related components.

Post suspension system vehicles may experience drive line vibrations. Angles may require tuning, slider on shaft may require replacement, shafts may need to be lengthened or trued, and U-joints may need to be replaced.

Secure and properly block vehicle prior to installation of BDS Suspension components. Always wear safety glasses when using power tools.

If installation is to be performed without a hoist, BDS Suspension Co. recommends rear alterations first.

Due to payload options and initial ride height variances, the amount of lift is a base figure. Final ride height dimensions may vary in accordance to original vehicle attitude. Always measure the attitude prior to beginning installation.

BEFORE YOU DRIVE

Check all fasteners for proper torque. Check to ensure for adequate clearance between all rotating, mobile, fixed, and heated members. Verify clearance between exhaust and brake lines, fuel lines, fuel tank, floor boards and wiring harness. Check steering gear for clearance. Test and inspect brake system.



Visit 560plus.com for more information.

TRACTION CONTROL

In an effort to reduce the risk of rollover crashes the National Highway Traffic Safety Administration (NHTSA) established the Federal Motor Vehicle Safety Standard (FMVSS) No. 126 requiring all new passenger vehicles under 10,000 lbs GVWR include an electronic stability control (ESC) system as standard equipment. Effective August 2012 this law requires aftermarket products to be compliant with these same standards.



TIRES AND WHEELS

FITMENT GUIDE

35 x 12.50 on 20x9 or 20x10 w/ 5" Max Backspacing
35 x 12.50 on 18x9 or 20x10 w/ 5" Max Backspacing

*See additional tire fitment information under troubleshooting notes.



Perform steering sweep to ensure front brake hoses have adequate slack and do not contact any rotating, mobile or heated members. Inspect rear brake hoses at full extension for adequate slack. Failure to perform hose check/ replacement may result in component failure. Longer replacement hoses, if needed can be purchased from a local parts supplier.

Perform head light check and adjustment.

Re-torque all fasteners after 500 miles. Always inspect fasteners and components during routine servicing.

CONTENTS OF YOUR KIT

021800/021801 - Aluminum/ Stamped Steel Control Arms 021810/021811 - Cast Steel Control Arms

Part #	Qty	Description
03436	1	Steering Knuckle - Drv
03437	1	Steering Knuckle - Pass
03521	1	Steering Knuckle - Drv (Cast Steel)
03522	1	Steering Knuckle - Pass (Cast Steel)
401-2038	2	Tie Rod Ends
02487	2	Lower Balljoint Spacer
01499	2	Upper Balljoint Spacer

021802 Front Box Kit (1 of 2)

Part #	Qty	Description
03439	1	Front Crossmember
03440	1	Rear Crossmember
03441	1	Diff Drop Brkt - Driver
03442	1	Diff Drop Brkt - Pass
A304	1	Center Diff Support - Assmebly
03443	1	Center Diff Support Brkt
MB08B708550	2	Bushing
200-05196	4	Differential Mount Spacer
467	1	Bolt Pack - Differential Brackets
	2	1/2"-13 x 1-3/4" bolt
	2	1/2"-13 prevailing torque nut
	4	1/2" SAE washer
	2	5/8"-11 x 1-3/4" bolt
	2	5/8" SAE Thru hardened extra thick washer
	2	5/8" SAE washer
	2	5/8"-11 prevailing torque nut
	2	9/16"-12 x 4" bolt
	4	9/16" SAE washer
	2	9/16"-12 prevailing torque nut
	4	10mm-1.50 x 40mm bolt
	4	10mm flat washer

021803 Front Box Kit (2 of 2)

Part #	Qty	Description
02318B	1	Skid Plate - PASS
02175B	1	Skid Plate - DRV
03449	1	Skid Plate - Front
02166B	2	Sway Bar Spacer
02437	1	Driveshaft Boot Ext.
9262K821	1	O-Ring 42mm ID
9452K208	1	O-Ring Dash Number 322
B1240	1	Bag Kit - Front Components
03444	2	CV Spacer Washer
6865833	1	Drive Shaft Boot Clamp
01499	1	1/4" Spacer Washer - Skid Plate
02169	1	Weld-in Plate
03445	1	Front Brake Line Bracket - Drv
03446	1	Front Brake Line Bracket - Pass
099000	7	Cable Tie
342701	1	Loctite
B1042	1	Bag Kit - Sway Bar Links
21	2	.625 x .083 x 5.0 Sleeve
4805G	8	Small Stem Bushing
S10024	8	Stem Washer
B389G5	2	3/8-16 x 9" Bolt
468	1	Bolt Pack - ABS/Skid Plate
	4	Wire Clip
	2	1/4"-20 x 3/4" type 23 self tapping bolt - hex washer head
	1	5/16"-18 x 1" bolt
	1	5/16"-18 prevailing torque nut
	2	5/16" SAE washer
	7	1/2"-13 x 1-1/4" bolt
	7	1/2" SAE washer
449	1	Bolt Pack - Sway Bar Drop
	4	10mm-1.50 x 120mm socket head cap screw
	4	10mm flat washer
629	1	Bolt Pack - Strut Spacer
	6	10mm-1.50 prevailing torque nut
	6	38" USS washer
621	1	Bolt Pack - LCA Bolts
	2	5/8"-11 x 4-1/2" bolt
	2	5/8"-11 x 5-1/2" bolt
	4	5/8"-11 lock nut
	8	5/8" SAE washer

021804 Strut Spacer Box Kit		
Part #	Qty	Description
03438	2	Strut Spacer
992	1	Bolt Pack - Strut Spacer
	4	1/4"-20 x 1" Hex Drive Socket Head Screw
	4	1/4" Stainless Steel Washer
	4	1/4"-20 Stainless Steel Nylock Nut
03481	2	Strut Name Plate
01572	2	BDS Logo Badge
888	1	Rivet Bolt Pack

021607 Rear Box Kit		
Part #	Qty	Description
03447	2	6" Lift Block
111209R	2	GM Rear Add-a-Leaf
96212400QB	4	9/16" x 2-9/16" x 14" square u-bolt
03578	2	U-Bolt Plate
B1239	1	Rear Bag Kit
380412FCP	4	3/8" x 4.5" Pin & Nut
HKK250	4	2.5" Spring Clamp
03448	1	Brake Line Bracket
N96FH-B	8	9/16 Fine High Nut- Black
W96S-B	8	9/16 SAE Flat Washer-Black

TROUBLESHOOTING INFORMATION FOR YOUR VEHICLE

- Requires frame bracket and differential modification.
- 18" wheels 5" maximum backspacing; 20" wheels 5-1/2" maximum backspacing (clearance to the upper control arm may be close with certain wheel / tire combinations at 5-1/2" backspacing). No 17" aftermarket wheels will work. Factory 17", 18", and 20" wheels cannot be reinstalled due to tie rod end or upper balljoint interference
- Trucks with stock aluminum steering knuckles will require 021800/021801 box kit instead of 021810/021811**
- Will not fit MagneRide magnetic ride control equipped models

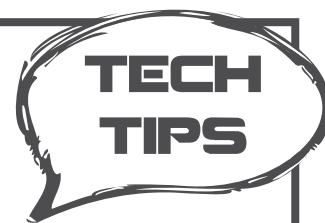

INSTALLATION INSTRUCTIONS

MEASURE FIRST

Measure from the center of the wheel up to the bottom edge of the wheel opening:

LF _____ RF _____

LR _____ RR _____

SPECIAL TOOLS

36mm Socket - Hub Nut
 Welder
 Reciprocating Saw
 Grinder/ Sanding Disc
 Large C-Clamps
 CV Boot Clamp Pliers
 Rivet Gun

DO YOU KNOW IF YOUR TRUCK HAS CAST STEEL OR ALUMINUM/STAMPED STEEL CONTROL ARMS?

Verify whether the truck has cast steel or aluminum/stamped steel control arms. This kit is specific for each type of steering knuckles due to differences in balljoint taper.

Vehicles equipped with aluminum or stamped steel control arms use box kit **021800/021801**.

Vehicles equipped with cast steel control arms use box kit **021810/021811**.

RECALL NOTICE

GM issued a safety recall (#42190) for some 2016-17 vehicles built before 4/8/16 that were equipped with stamped steel upper control arms due to poor weld quality. BDS strongly recommends checking if your vehicle is included in the recall and having the fix performed before installing this suspension system.

WELDING IS REQUIRED

The installation of this kit requires minor welding of a reinforcement plate. We recommend this procedure be performed by an experienced welder. If necessary, this kit can be completely installed and then driven to a shop to have the plate welded. This method will make reaching the weld locations slightly more difficult but it can be done if necessary.

FRONT DISASSEMBLY

1. Park the vehicle on a clean, flat surface and block the rear wheels for safety.
2. Disconnect the positive and negative battery cables from the battery.
3. Raise the front of the vehicle with a hydraulic jack and support the frame with jack stands. Remove the wheels.
4. Disconnect the ABS line from the connector on the frame (Fig. 1). Remove the ABS line from the retaining clips at the frame, upper control arm and knuckle. Disconnect the brake line bracket from the upper control arm (Fig. 1). Save bolt.

FIGURE 1



5. Remove the splash guard from the vehicle. (Fig 2)

FIGURE 2



6. Disconnect the tie rod from the knuckle (Fig. 3). Remove the tie rod end nut. Steel Knuckle: Strike the knuckle near the tie rod end with a hammer to unseat the taper. Aluminum Knuckle: Avoid striking the knuckle, typically the taper unseats more easily and gently hitting the end of the tie rod end will unseat the taper. A pickle fork can also be used.

FIGURE 3

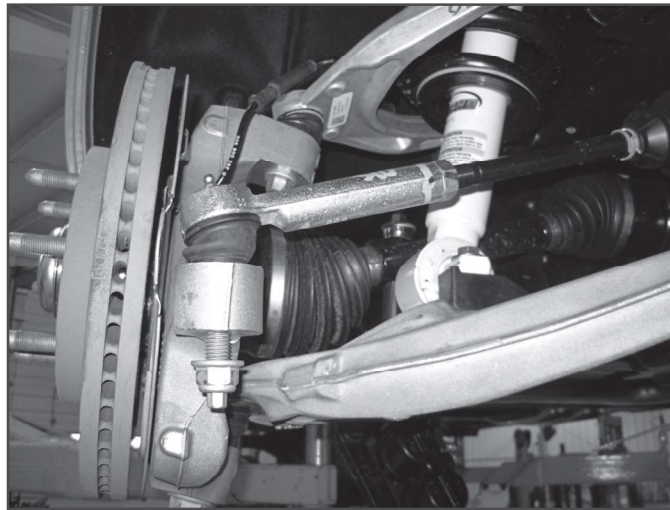

7. Remove the two brake caliper mounting bolts and remove the caliper from the knuckle (Fig. 4). Hang the caliper securely out of the way DO NOT hang the caliper by the brake hose. Save caliper bolts.

FIGURE 4

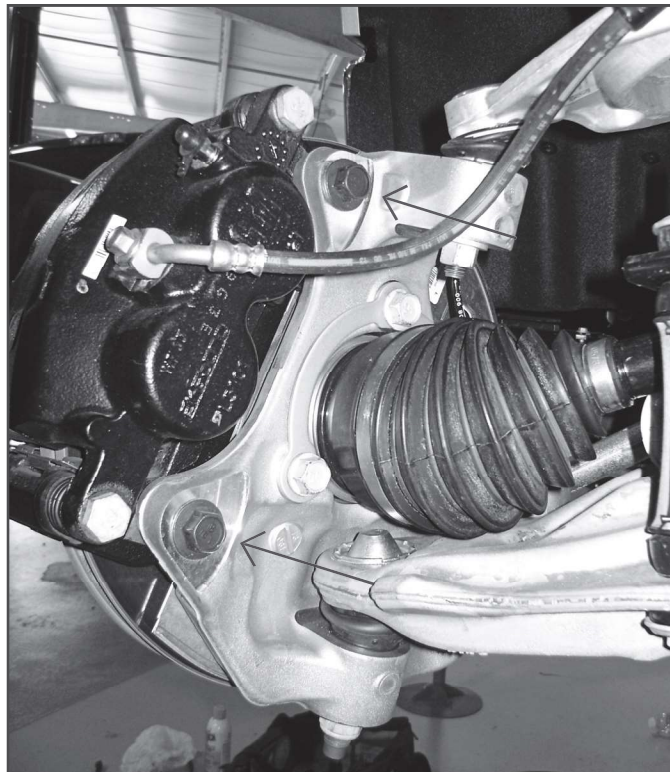

8. Remove the brake rotor retaining bolt and remove the rotor from the vehicle.
9. Remove the hub dust cap (Fig. 5). Remove the axle shaft nut. Retain nut and cap.



Tip Use a small chisel and hammer to carefully separate the edge of the cap from the hub. Work around the circumference of the cap. The axle nut will require a 36mm socket.

FIGURE 5

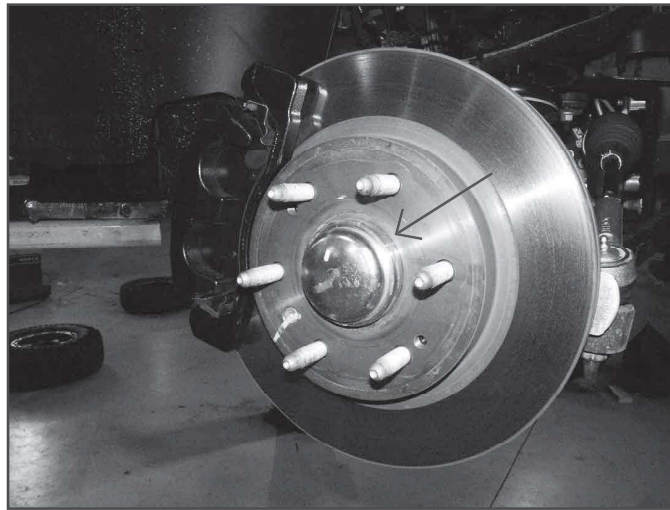

10. Remove the sway bar links from the sway bar and the lower control arm (Fig. 6).

FIGURE 6

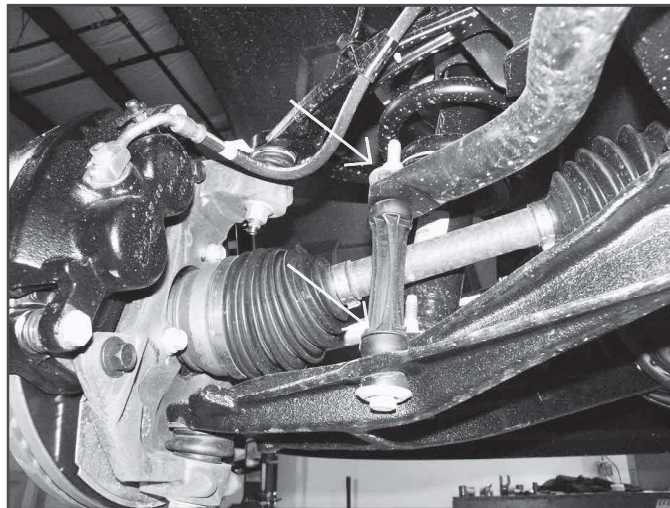

11. Mark the orientation of the sway bar and remove it from the frame by removing the four bushing cap mounting bolts (Fig. 7). Save all sway bar components.

FIGURE 7

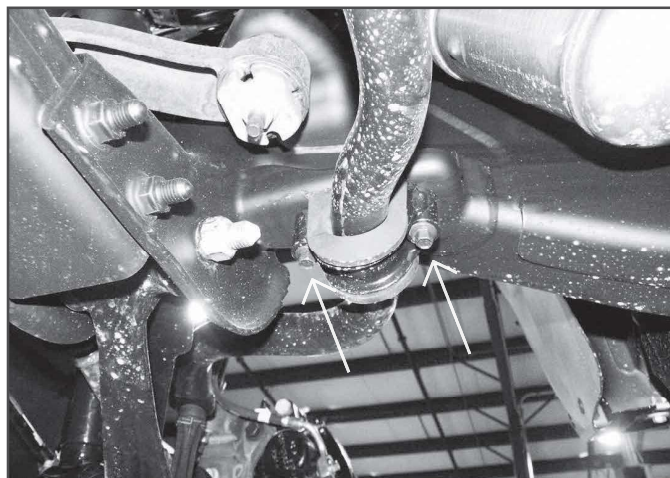

12. Mark each of the front strut bodies to indicate driver's versus passenger's side.

- Support the lower control arm with a jack. Remove the lower strut mount bolts (Fig. 8). Save bolts.

FIGURE 8

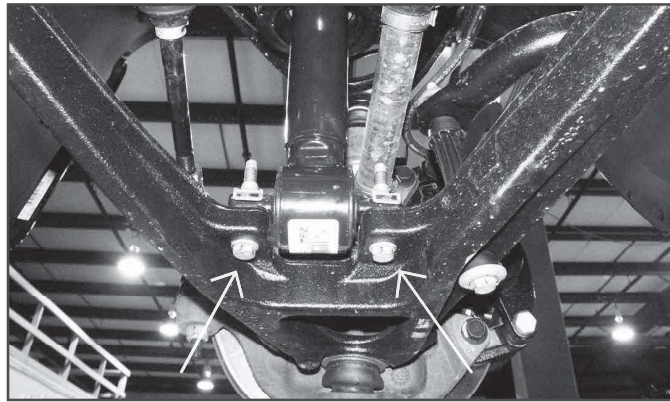

- Remove the CV shaft mounting flange bolts (6 per side) (Fig. 9). Mark the shaft to indicate driver's or passenger's side. Save hardware the bolts will be reused.

FIGURE 9

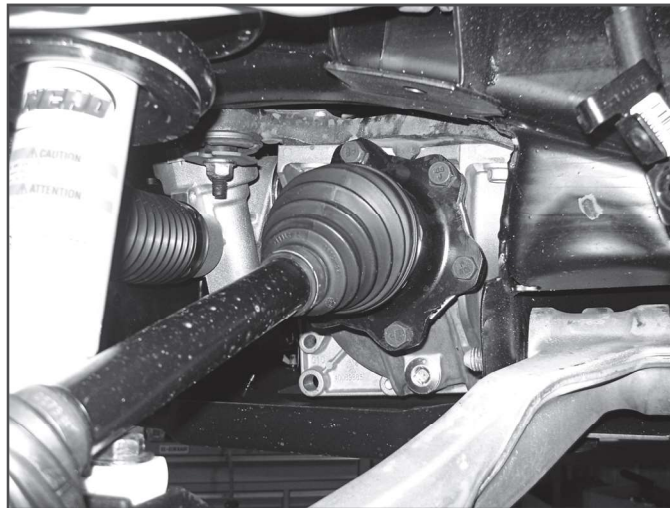

- Remove the upper and lower ball joint nuts and thread back on by hand a couple of turns. **Steel Knuckle:** Strike the knuckle near the upper and lower ball joints to dislodge the tapered seat. **Aluminum Knuckle:** Avoid striking the knuckle to release the taper, a pickle fork or pry bar can be used to apply a splitting force. Gently hit the end of the ball joint to get it to release. If you do resort to hitting the knuckle avoid re-use and discard.
- Remove the upper ball joint nut and lower the lower control arm down. Remove the CV shaft from the hub and set aside. Remove the lower ball joint nut and remove the knuckle assembly from the lower control arm. Save ball joint nuts.
- Remove the three upper strut mounting nuts (Fig. 10) and remove the strut from the vehicle. **DO NOT** remove the center strut rod nut, it is under extreme pressure. Save nuts.

FIGURE 10

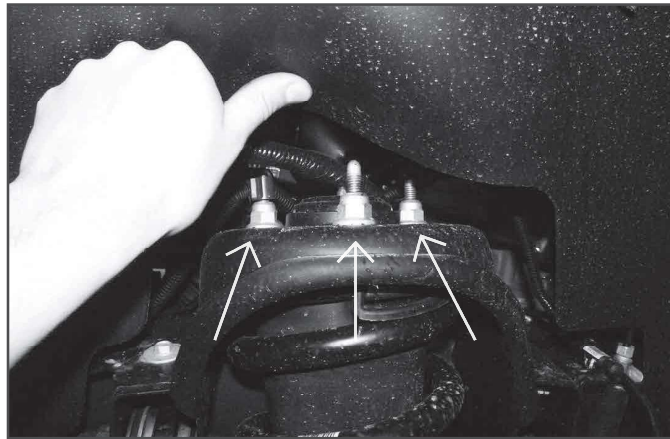

18. Remove the front and rear lower control arm mounting bolts and remove the lower control arm from the vehicle. Save mounting hardware and control arms.
19. Remove the crossmember struts. (Fig 11)

FIGURE 11

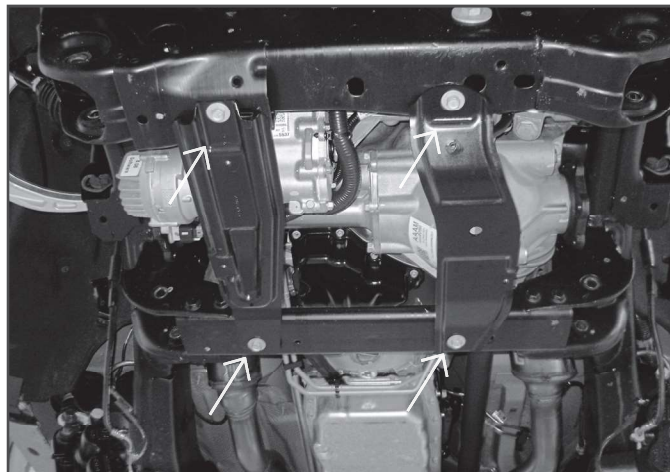

20. Remove the factory rear crossmember from the vehicle by removing the 4 bolts. (Fig 12) Crossmember and hardware will not be reused.

FIGURE 12

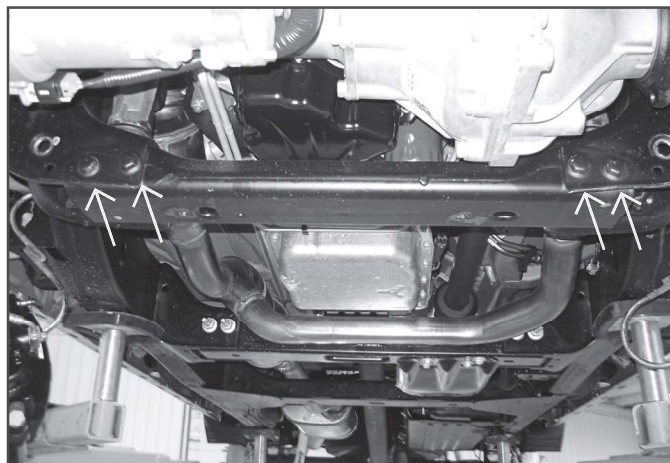

21. Make an alignment mark to show the relationship between the front driveshaft and the differential yoke. Remove the four driveshaft bolts and disconnect the driveshaft from the differential. Save bolts. (Fig. 13)

FIGURE 13



22. Remove the front drive shaft from the transfer case. The boot will need to stay connected to the transfer case, but be removed from the driveshaft end.

Note: Do not remove the boot from the transfer case side, only from the driveshaft side.

23. The driver's side rear lower control arm pocket must be cut to provide clearance for the front differential in the relocated position. This also aids in the removal of the differential. This area needs to be cleaned of any oil, grease and/or undercoating. These coatings are flammable.



Tip A putty knife and parts cleaning solvent work well to remove undercoating.

24. Measure from the inside of the driver's side control arm pocket out 3-1/2" and mark. Repeat this measurement on the opposite side of the pocket. Make vertical cut lines at the 3-1/2" mark up both front and back faces of the pocket (Fig. 14).

FIGURE 14 - SHOWN WITH DIFFERENTIAL REMOVED FOR CLARITY

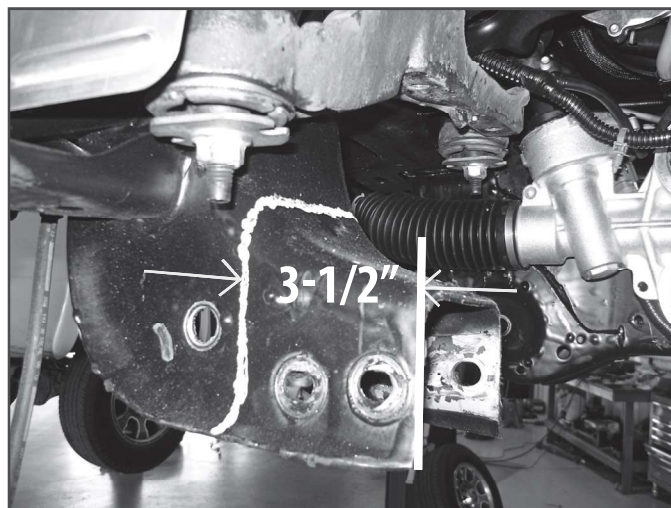

25. Make a vertical cut along each of the cut lines on the front and back faces of the control arm pocket with a reciprocating saw (recommended), cut-off wheel or plasma cutter. Be careful, the undercoating on the frame is flammable and can melt and drip off the frame. Keep a fire extinguisher near by.
26. With the vertical cuts complete, cut the top portion of the pocket by connecting the two cuts.

27. Disconnect the differential actuator wire connector from the actuator (Fig. 15). Remove the three wire harness clips holding the actuator harness to the differential housing.



Tip *If you are having difficulty accessing the plug, wait until the differential is being lowered to disconnect it.*

FIGURE 15

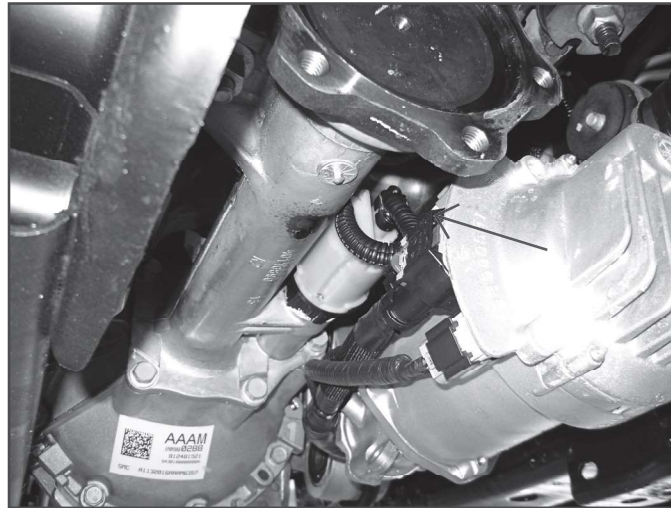

28. Disconnect the differential breather hose (Fig. 16).

FIGURE 16

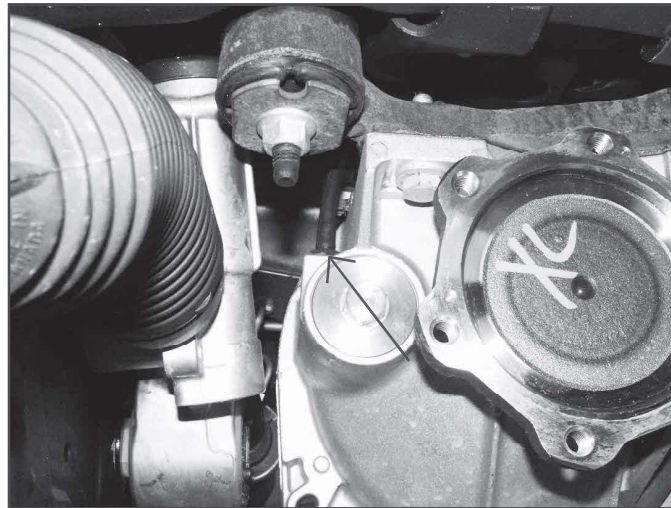

29. Support the front differential with an appropriate jack. Remove the two driver's side differential mounting bolts (Fig. 17) and the two passenger's side mounting nuts. Carefully lower the differential to the ground. Save mounting hardware.



Tip *We highly recommend having an assistant to help with removal of the front differential.*

FIGURE 17

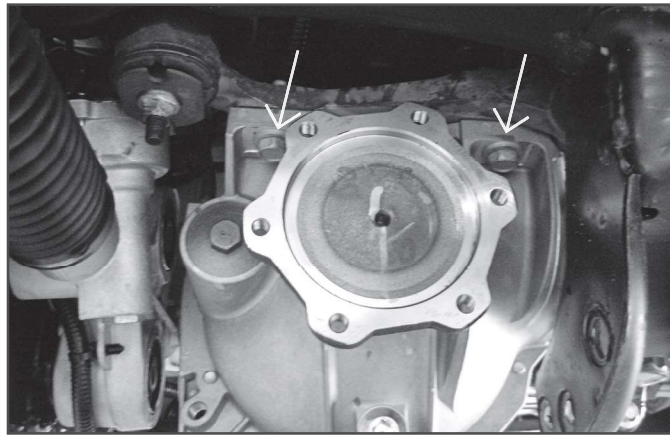

DIFFERENTIAL MODIFICATION

30. The lower tab of the differential will need to be trimmed to clear the high clearance skid plates as shown in Figures 18 A & B.

Note: Figure 18B is shown with the skid plate installed to show clearance.

FIGURE 18A

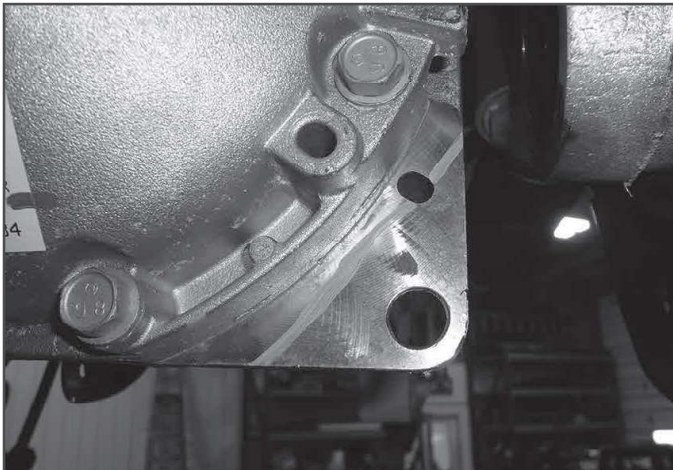

FIGURE 18B



31. The fin on the driver side behind the CV shaft mount will need to be trimmed to provide clearance to the rear crossmember as shown in Figure 19A.

32. The rear side of the passenger mount needs to be trimmed for clearance to the factory control arm pocket. Measure 1 inch from the center of the slot and mark a cut line. Figure 19B. Using a reciprocating saw, cut at the line.

FIGURE 19A

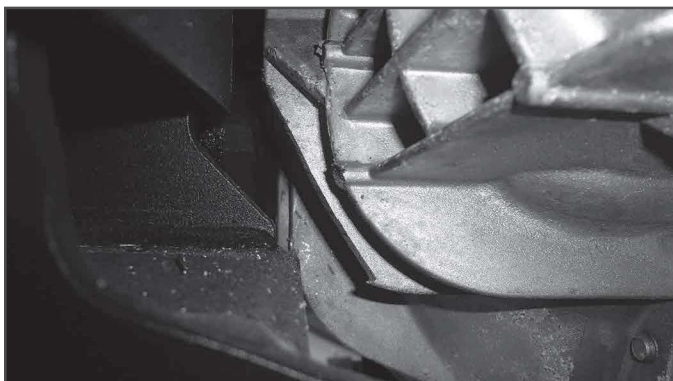
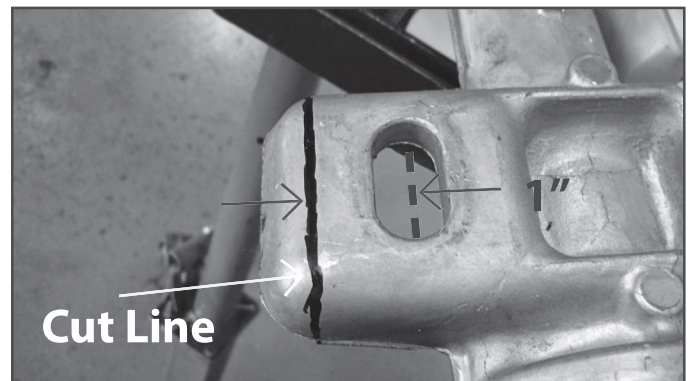
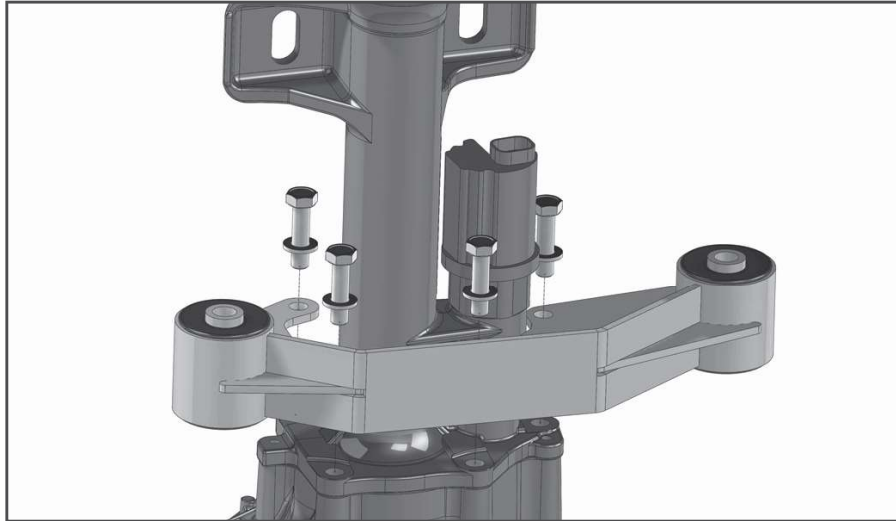

FIGURE 19B



33. Locate the center differential bracket (A304) and 10mm x 40mm bolts and washers from Bolt Pack 467. Remove the 4 housing bolts and install the differential bracket with the provided hardware using some Loctite. Torque bolts to 33 ft-lbs. Take care not to break the gasket seal. (Fig. 20)

FIGURE 20



DIFFERENTIAL INSTALLATION

34. Place the provided weld-in plate (02169) up against the cut edge of the control arm pocket. The plate should be flush with the bottom edge of the pocket and overhang the front and back outside surfaces an equal amount. The chamfered corner of the plate should be in the top-front position (Fig. 21). Tack weld the plate in place.



Tip *Welding should be performed by an experienced welder. See pre-installation notes at the beginning of these instructions.*

FIGURE 21

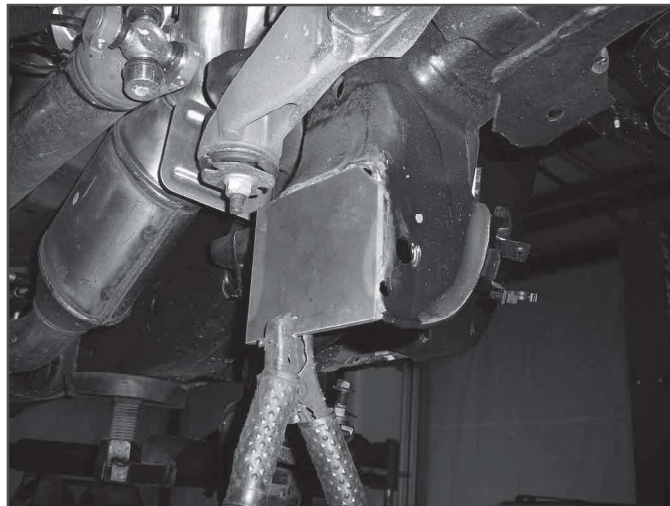

35. With the plate tacked, go back and weld the plate in place. Weld along the OUTSIDE of the pocket on the vertical surfaces. Welding on the inside will result in crossmember interference. Weld along the top edge of the plate on the inside of the pocket. Once the area has cooled, paint all exposed metal to prevent corrosion.
36. Install the new driver's side differential bracket (03441) to the original mount with the factory bolts (Fig. 22). The side with the formed end mounts to the OE mount and the open face points toward the inside of the vehicle. Torque bolts to 65 ft-lbs.

FIGURE 22



37. Install the new passenger's side differential bracket (03442) to the original mounting studs with the factory nuts (Fig. 23). Install a 5/8" bolt and washer from Bolt Pack 467 top down into the front hole on the passenger's side differential bracket before the bracket is installed. The bracket is cleared for the electronic steering rack and mounts with the open face toward the inside of the vehicle. Torque nuts to 65 ft-lbs.

FIGURE 23 - SHOWN WITH DIFFERENTIAL ALREADY INSTALLED



38. Install the differential to the new driver's and passenger's differential brackets. Fasten the differential to the driver side bracket with 1/2" x 1-3/4" bolts, nuts and washers from Bolt Pack 467. Use the 5/8" bolts, 5/8" SAE washers and extra thick 5/8" washers on the passenger's side. The extra large washer will go against the differential housing flange with the large slots. Leave hardware loose.

Note: GM used different style electric motors for the rack and pinion steering for different year trucks. Check clearance between the differential bracket and electric motor. Once the differential is installed, the slots in the differential will allow the differential drop bracket to be pulled slightly away from the electric motor.

39. Reconnect the differential actuator wiring. Reattach the wire to the differential housing with the factory clips.
40. Reconnect the differential breather line. The line will need to be removed from retaining clips above to gain slack.



Tip

The breather line may need to be accessed through the engine compartment to be rerouted for more slack.

DRIVESHAFT INSTALLATION

41. Locate the driveshaft boot extension (02437) and o-rings (9262K821 & 9452K208). Install the o-rings into the appropriately sized grooves in the extension. Apply grease to the o-rings and slide the extension over the driveshaft with the large diameter first until o-ring snaps over the factory boot lip (Fig 24A & B). Re-install the boot on the extension with the factory clamp.

Note: The extension is a tight fit over the spines, use adequate lube and push the extension on squarely to prevent tearing the o-ring.

FIGURE 24A



FIGURE 24B

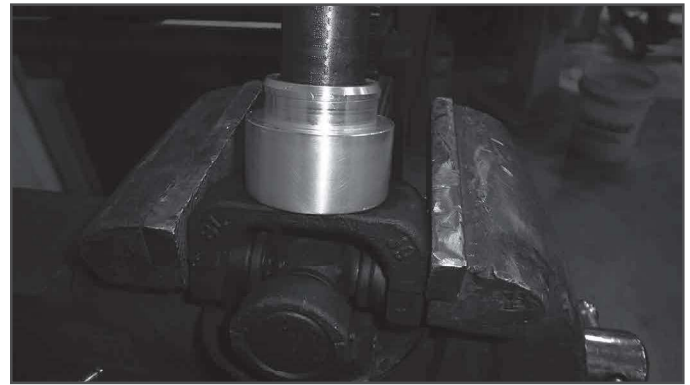

42. Slide the driveshaft into the transfer case and reattach it to the differential as it was removed with the original hardware. Torque bolts to 19 ft-lbs.
43. Attach the boot to the drive shaft boot extension. Attach the boot to the boot extension with the provided boot clamp (6865833) using CV boot clamp pliers (Fig. 25).

FIGURE 25



CROSSMEMBER INSTALLATION

44. Install the new rear crossmember (03440) with the factory lower control arm bolts, nuts and washers. The tabs on the crossmember should align with the center diff bracket. Run the bolts from front to rear. Leave hardware loose.
45. Install the front crossmember (03439) in the control arm pockets with the factory lower control arm bolts, nuts and washers. Run bolts from front to rear. Leave hardware loose.
46. Install the 9/16" x 4" bolt and hardware from Bolt Pack 467 in the center differential bracket at the front and rear crossmembers. Torque all differential mount hardware: 1/2" hardware to 65 ft-lbs, 9/16" hardware to 90 ft-lbs and the 5/8" hardware to 120 ft-lbs.
47. Loosely attach the differential skid plates (02318B and 02175B) to the rear crossmember with three 1/2" x 1-1/4" bolts and 1/2" SAE washers from Bolt Pack 468 in the threaded holes in the crossmembers. Install the front skid plate (03449) to the frame with the factory hardware. The differential skid plates will sandwich between the front skid plate and front crossmember also using 1/2" x 1-1/4" bolts. Use Loctite on all skid plate bolts. Leave hardware loose. (Fig. 26A & B) Use the provided 1/4" spacer washer (01499) on the 4th bolt hole in the front crossmember. The spacer washer location is pointed out in Figure 26B.

FIGURE 26A



FIGURE 26B

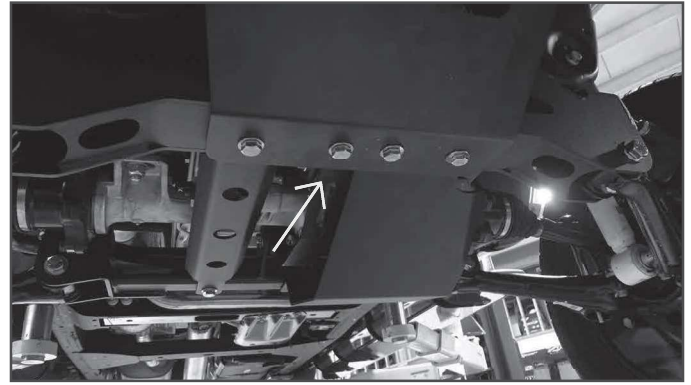

48. Install the OE lower control arms in the new crossmembers and fasten with 5/8" x 4-1/2" (front) and 5/8" x 5-1/2" (rear) bolts, nuts and 5/8" SAE washers from Bolt 621. Run the bolts from front to rear. Leave hardware loose.
49. With the crossmembers, control arms, skid plate and support strut installed, go back and torque the crossmember mounting bolts to 125 ft-lbs and the skid plate hardware to 65 ft-lbs.

STRUT ASSEMBLY

50. Install the provided strut spacers on the struts with provided 10mm nuts and washers from Bolt Pack 629. The spacers will only install one way. Torque the hardware to 30 ft-lbs (Fig. 27).

FIGURE 27



51. Install the provided strut name plate assembly with the provided 1/4" stainless steel hardware from Bolt Pack 992 to the strut spacer (Fig. 28). The badge can now be riveted on to the name plate assembly using the provided 1/8" rivets. Any residue on the badge can be cleaned up using alcohol or brake cleaner before install. With the badge not installed it can be painted to what ever color you desire, or left raw as a stainless steel badge.

FIGURE 28

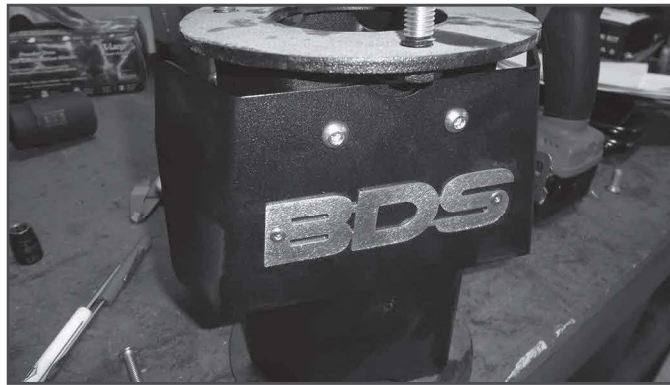

FRONT ASSEMBLY

52. Install the new strut assembly to the appropriate frame mount with the factory flange nuts. Leave hardware loose.
53. Swing the lower control arm up to the strut and fasten it with the original mounting bolts. Torque lower and upper strut hardware to 40 ft-lbs. strut is oriented properly in the vehicle.
54. Remove the hub bearing/rotor assembly and brake dust shield from the factory steering knuckles. Be sure to note which hub goes on which side of the vehicle. Save mounting bolts.
55. The brake dust shield needs to be trimmed. Measure in from the lower vertical edge (opposite the ABS sensor location) 1/2" and make a straight line to the edge shown in Figure 29. Cut the section off of the brake dust shield.

FIGURE 29

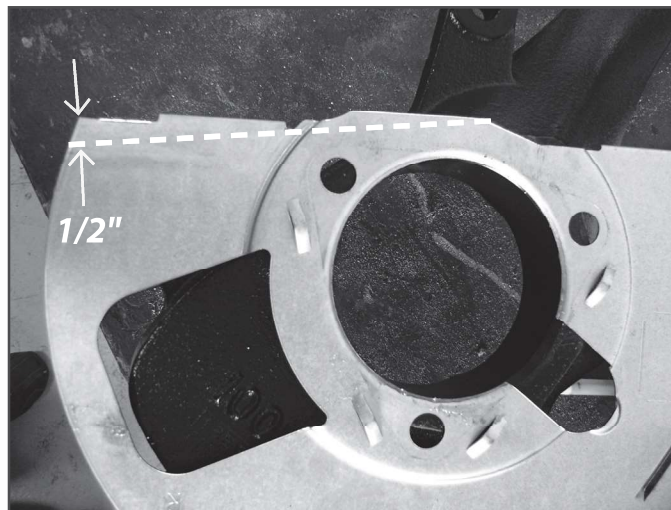

56. Install the modified dust shield and hub/rotor in the corresponding new knuckles. Fasten the hub/shield with the OE bolts. Apply Loctite to the bolt threads and torque to 133 ft-lbs. Be sure that the ABS line is run properly through the dust shield and out above the steering arm on the knuckle.
57. Install the assembled knuckle on the lower control arm. For aluminum and stamped steel applications, use the provided aluminum spacer washer between the knuckle and the nut.
58. Attach the knuckle to the upper control arm with the original upper ball joint nut using the provided spacer washer between the nut and the knuckle.



Tip To make connecting the upper ball joint easier, loosen the upper control arm cam bolts at the frame and rotate the cams to shift the control arm outward. You can also lightly pry down on the arm off of the coil spring.

59. Install the factory CV axle shaft into the hub, with the provided spacer washer (03444), and fasten with the original nut/washer and torque to 155 ft-lbs. Install dust cap. The spacer washer should be installed with the chamfer towards the center of the vehicle (Fig. 30).

FIGURE 30

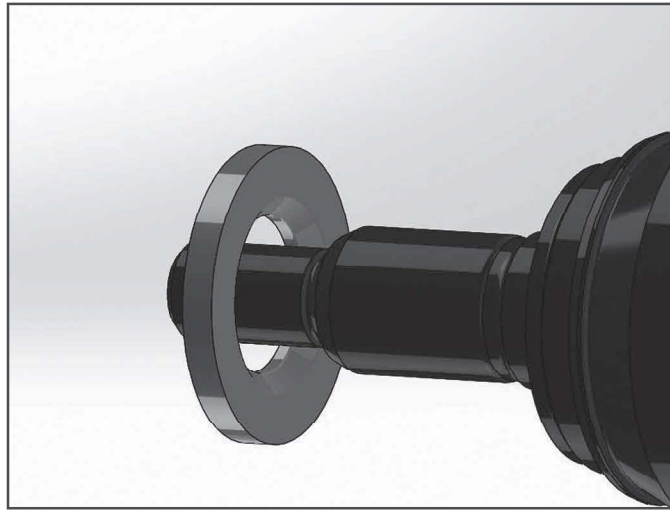

60. Torque the upper ball joint nut to 37 ft-lbs and the lower ball joint nut to 74 ft-lbs.
61. Fasten the CV to the differential flange with the factory hardware. Use Loctite on the bolt threads and torque to 45 ft-lbs using a crossing pattern (Fig. 31).

FIGURE 31



62. Remove the factory tie rod ends and install the new provided tie rod ends. Leave approximately 1/8" of threads showing on the steering link.
63. Remove the front brake line retaining clips and slide the brake line through the bracket. To avoid having to bleed the brakes, cut an opening in the factory brake line bracket so the bracket can be removed from the line. Take care not to nick the brake line. Disconnect the bracket from the frame. Save hardware.



Tip *If you are not comfortable with cutting the bracket, disconnect the rubber line from the hard line. The brake system will have to be bled upon completion.*

64. Attach the caliper to the new steering knuckle with the original mounting hardware. Torque bolts to 125 ft-lbs.
65. Carefully remove the metal retainer bracket from the factory rubber brake line. This can be done with two vice grips, pliers, or crescent wrenches.



Tip *It may be easier to remove the brake line from the bracket by removing it from the vehicle completely and holding the bracket in a bench vise. If the brake line is removed, the system will need to be bled.*

66. Align the tab in the provided brake line brackets (03445 & 03446) to the upper control arm mount and attach the bracket using the original mounting hole and OE bolt (Fig. 32) Torque the brake line bracket to 20 ft-lbs.

FIGURE 32

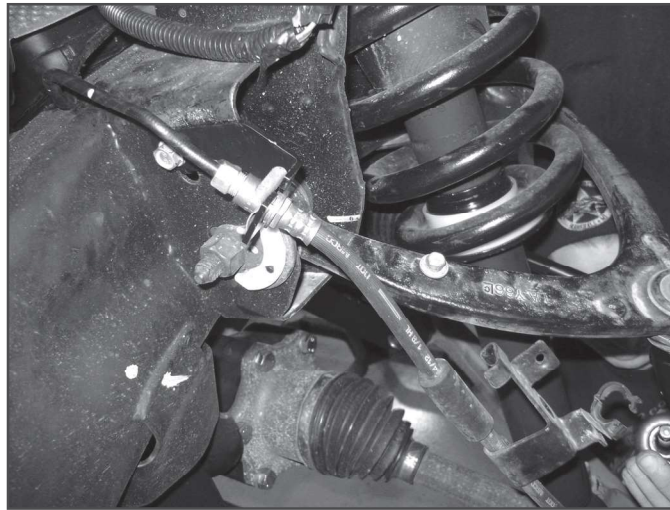

67. Carefully reform the brake hard line down so it meets the new bracket. Run the end of the rubber brake hose through the bracket and retain the brake line to the bracket with the original clip.
68. Attach the ABS line to the upper control arm with the original brake line mounting bolt and provided wire clamp. (Fig. 33)

FIGURE 33

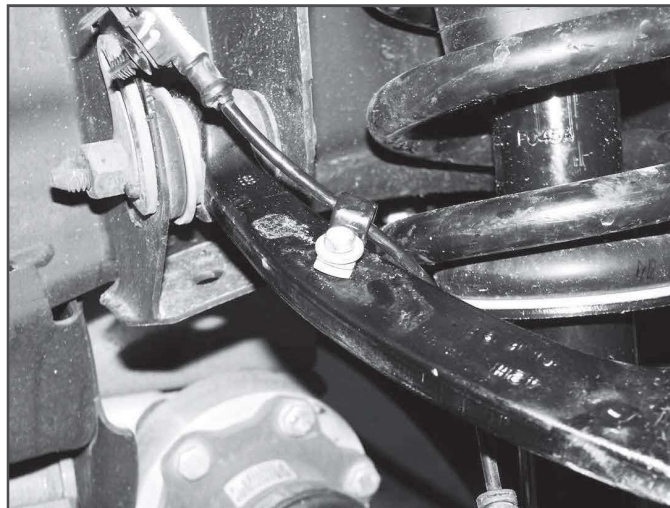

69. Reconnect ABS line at the frame. Attach the ABS line to the steering knuckle with the provided wire clamps and 1/4" x 3/4" self tapping bolt and flat washer from Bolt Pack 468. Torque bolt to 15 ft-lbs. Use zip ties to retain the remaining section of the ABS line as needed to keep it away from rotating objects. (Fig. 34)

FIGURE 34



70. Attach the front sway bar to the original mounts in the stock orientation in conjunction with the provided drop brackets (02166B) and 10mm bolts/washers from Bolt Pack 449. Use Loctite on the bolt threads and torque to 45 ft-lbs. (Fig. 35)

FIGURE 35

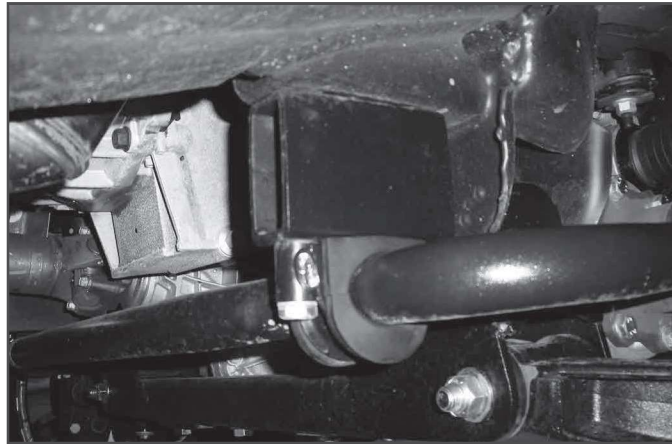

71. The new sway bar links will be built from a 5" sleeve, 3/8" x 9" bolt, bushings and cup washers. Attach these to the sway bar followed by the control arm with the bolt going from the top down. (Fig. 36) Tighten the sway bar link until the bushings begin to form to the control arm surface.

FIGURE 36

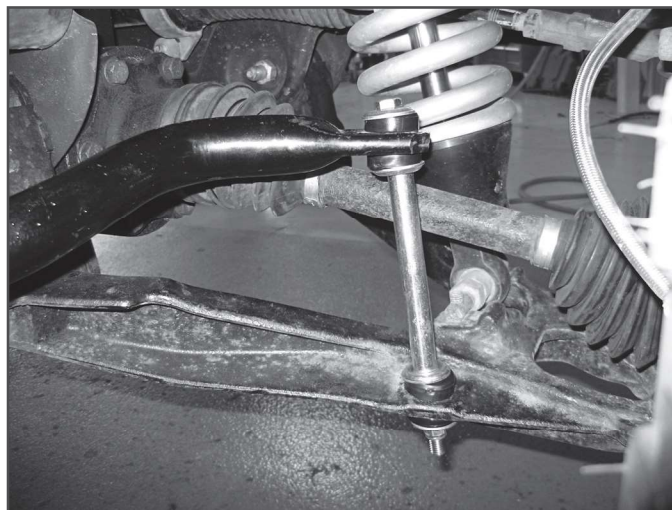

72. Connect the steering tie rod ends to the knuckles with the short provided nylock nuts. Ensure the nut has full thread engagement. Torque to 44 ft-lbs. Tighten the tie rod end jam nuts securely. They will be adjusted during alignment.
73. Install the wheels/tires and lower the front of the vehicle to the ground. Torque lug nuts to 140 ft-lbs.
74. Bounce the front of the vehicle to settle the suspension. Torque the lower control arm mounting bolts to 150 ft-lbs. If the upper control arm cam bolts were loosened during the installation, center the cams and torque the bolts to 125 ft-lbs.
75. Check differential and CV shafts for clearance in all areas including those cut for clearance.
76. Check all hardware for proper torque.
77. If necessary, bleed the entire brake system. See service manual for proper brake system bleeding procedures.
78. Reconnect the battery cables to the battery.

REAR INSTALLATION

1. Block the front wheels. Safely raise the rear of the vehicle and support with jack stands just ahead of the front leaf spring frame mount.
2. Remove the wheels.
3. Support the rear axle with a floor jack.

4. Disconnect the rear brake line bracket from the top of the differential (Fig. 37). Save hardware.

FIGURE 37

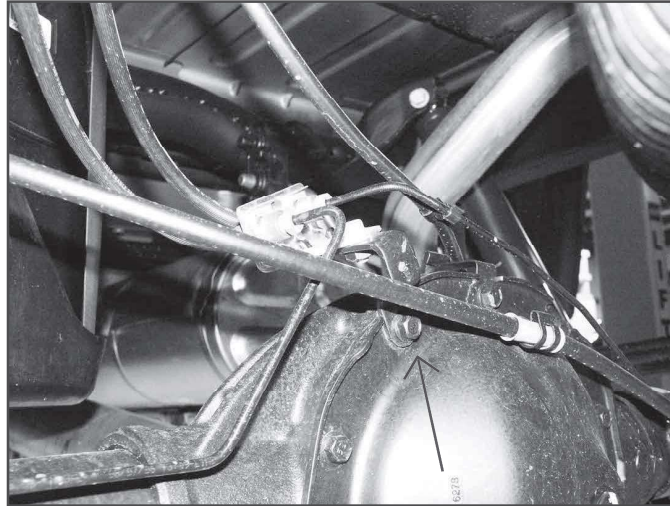

5. Remove the ABS lines from the retaining clip on the bottom of each frame rail. Also disconnect the ABS line connector from the top of the frame rail. (Fig. 38).

FIGURE 38

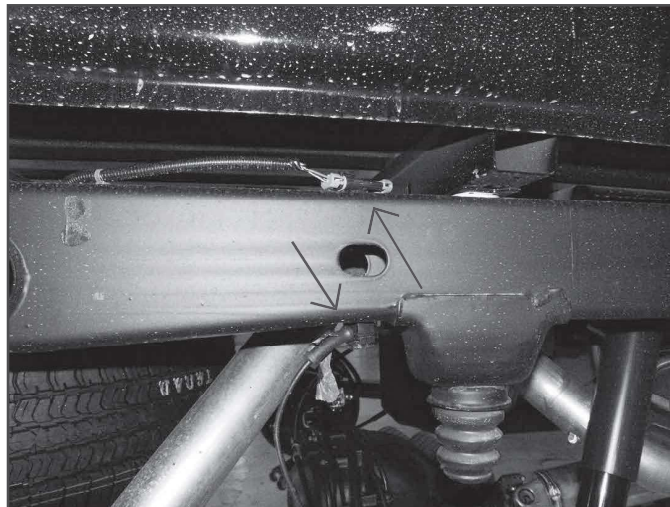

6. Remove the ABS line connector from the axle end underneath the leaf springs.
7. Remove the driver's side parking brake cable brackets from the driver's side frame rail. (Fig. 39)

FIGURE 39

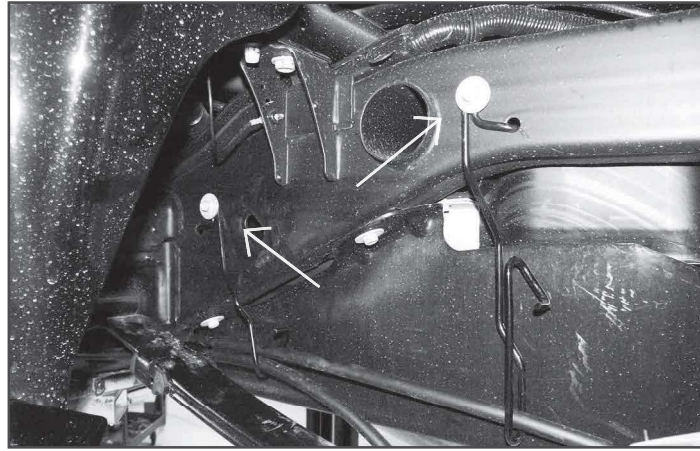

8. Support the center of the axle with a hydraulic jack. Remove the factory shocks from the axle and frame. Save hardware and discard shocks.

ADD-A-LEAF AND REAR LIFT BLOCK INSTALLATION

COMPLETE THE FOLLOWING STEPS ON ONE SIDE AT A TIME, STARTING WITH THE PASSENGER'S SIDE

9. With the axle still well supported, remove the passenger's side u-bolts. Set the hardware and factory u-bolt plate off to the side.
10. Lower the axle away from the spring and remove the factory lift block.
11. Fasten a C-clamp on each side of the leaf spring center pin. With the clamps in place, remove the center pin and discard.
12. Slowly release the C-clamps and allow the spring to come apart. Be sure to keep the spring leaves in order and oriented correctly.
13. Remove and discard the dowel pin in the lower flat overload leaf. (Fig. 40)

FIGURE 40



14. Place the new provided add-a-leaf between the factory lower flat overload leaf and middle leaf. Slide the new center pin up through the lower flat overload leaf, add-a-leaf and top two factory leaves. Remove the factory upper u-bolt plate and install the new u-bolt plate. Install the plate such that the long distance from the hole to the bend is towards the front of the vehicle (Fig. 41). Start the nut on the center pin to hold the pack together but do not use the center pin to pull the leaves together.

FIGURE 41

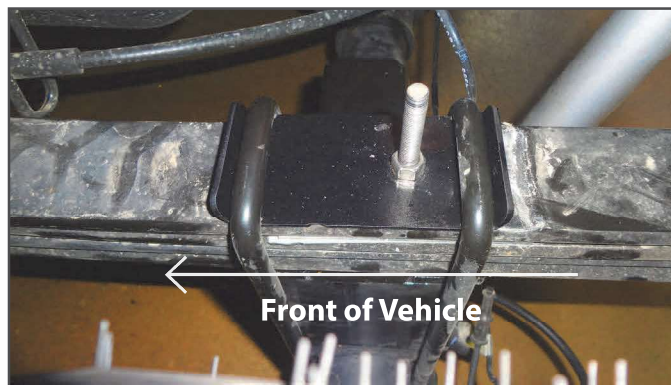

15. Place the C-clamps back on the leaf pack on each side of the center pin. Slowly pull the leaf pack together with C-clamps, make sure the leafs and U-bolt plate stay in line and the center pin is square. When the pack is completely together, torque the center pin to 30 ft-lbs. Remove the C-clamps.
16. Lower the axle just enough to install the new provided lift block between the axle and the spring. Position the block so the bump stop wing faces towards the inboard side of the vehicle. Align the pin in the block with the hole in the axle and the rear most hole in the block with the leaf spring pin. This will offset the rear axle forward. It may be necessary to loosen the driver's side u-bolts slightly to allow the axle to lower far enough to install the block.



Tip *The hole in the factory axle mount may need to be clearanced slightly for proper pin fitment.*

17. Using the support jack, raise the axle so that the axle, spring and block are all touching. Install the new provided u-bolts, nuts and washers allow with the factory u-bolt plate. (Fig. 42) Snug u-bolts but do not tighten.

FIGURE 42



18. Repeat the installation on the driver's side of the vehicle. Pay special attention to all of the brake lines and wires. Do not allow them to get over-extended.
19. Locate the new rear shocks. Install the provided bushings and steel sleeves into the eyes of the shocks. Lubricating the bushings and sleeves with some grease will make installation easier.
20. Install the new shocks with stock hardware and torque upper and lower bolts to 65 ft-lbs. The axle mounting tabs may need to be bent open slightly to allow for clearance of the larger diameter shocks.
21. Install the provided straight brake line bracket (03448) to the top of the differential using factory mounting hole and bolt which must be removed from the factory brake line bracket. Attach the factory brake line bracket to the relocation bracket with a 5/16" x 1" bolt, nut and washers from Bolt Pack 468. Torque the factory and 5/16" bolt to 20 ft-lbs. (Fig. 43)

Note: Be sure the ABS wire will not contact the exhaust.

FIGURE 43

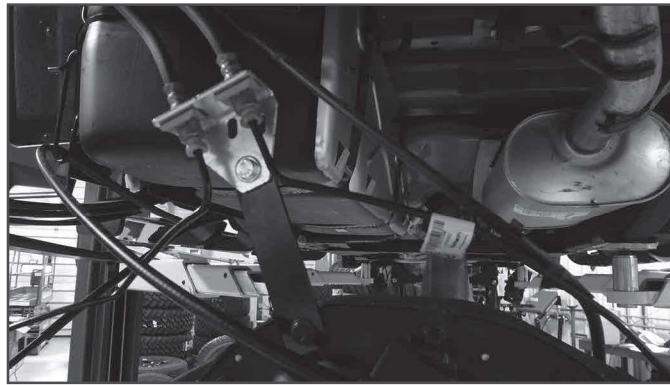

22. Reconnect the ABS lines to the plastic retaining clip at the bottom of each frame rail. The connector will not be reattached to the top of the frame. Reroute the lines as necessary to gain proper slack.
23. Reconnect the parking brake cable brackets to the driver's side frame rail with the original hardware. The driver's side cable will have to be removed from both rear brackets to gain appropriate slack. Torque bolts to 20 ft-lbs. Use the provided zip ties to attach the driver's side parking brake cable to the passenger's side where needed.
24. Install wheels and tires. Torque lug nuts to 140 ft-lbs. Lower vehicle.
25. Bounce the rear of the vehicle to settle the suspension. Torque leaf spring u-bolts to 100-120 ft-lbs. If new springs were installed, torque the spring-to-shackle and shackle-to-frame bolts to 70 ft-lbs. Torque the front spring hanger bolts to 125 ft-lbs.

POST INSTALLATION

26. Double check all fasteners for proper torque.
27. Check all moving parts for clearance.
28. Complete a full radius turning check to ensure that no interference occurs.
29. Align headlights
30. Double check the brake lines for adequate slack at full wheel travel.
31. Complete a vehicle alignment.
32. Check all fasteners after 500 miles.



WE WANT TO SEE YOUR RIDE!

Grab photos of your BDS-equipped truck in action and send them in for a chance to be featured. Send it in to our Bad Ass Rides customer gallery at bds-suspension.com/bar and post them on the BDS Fan Page on Facebook at facebook.com/BDSSuspensions. Don't forget about your BDS swag! BDS offers t-shirts, hoodies, decals and more available on the BDS website or through your local BDS distributor.

TIME TO HAVE SOME FUN

Thank you for choosing BDS Suspension.

For questions, technical support and warranty issues relating to this BDS Suspension product, please contact your distributor/installer before contacting BDS Suspension directly.