

INSTALLATION GUIDE

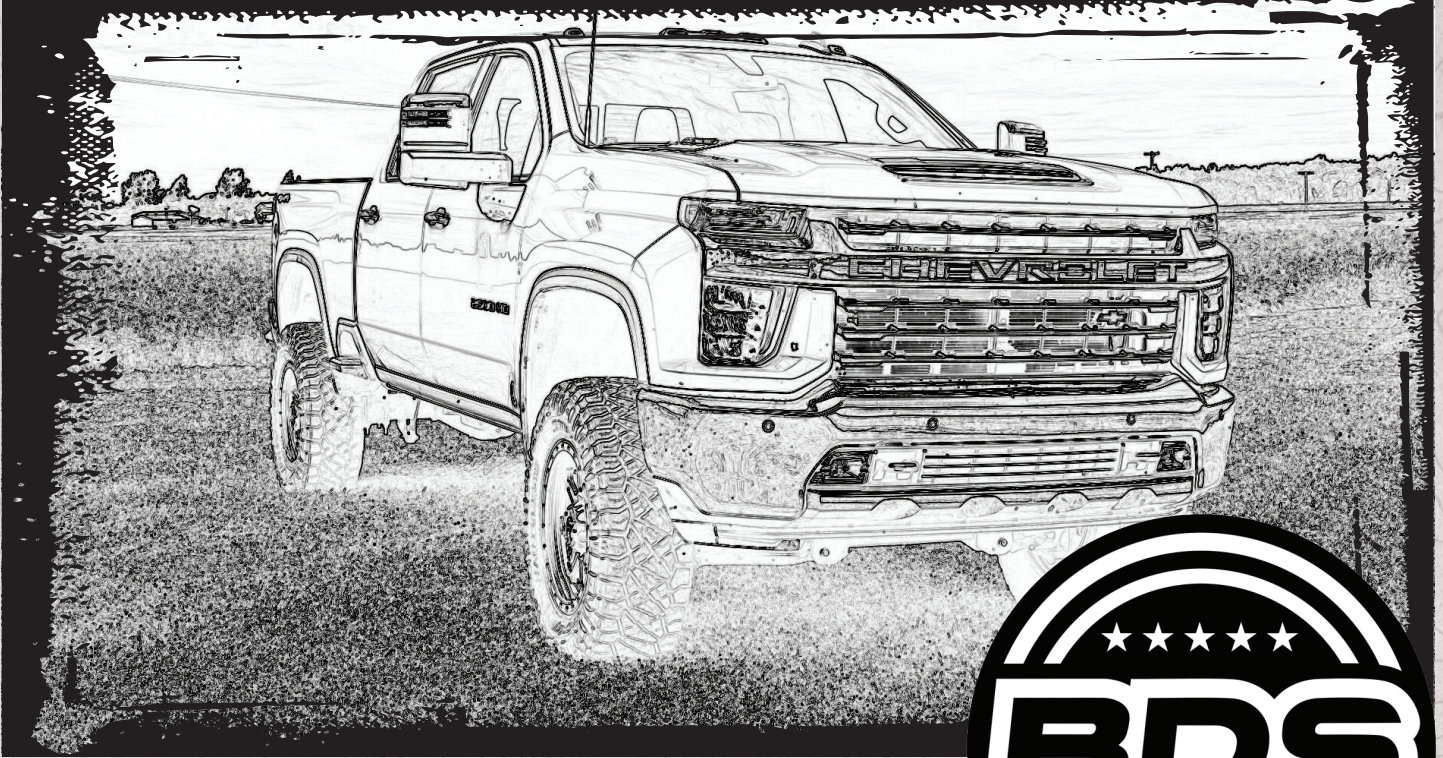

Part#: 011310

HARDCORE LIMITED LIFETIME WARRANTY

3" Suspension System

Chevy/GM 2500/3500 HD Pickup 2WD/4WD | 2020-2022

Rev. 051923

491 W. Garfield Ave., Coldwater, MI 49036 • Phone: 517-279-2135
E-mail: tech-bds@ridefox.com

Read And Understand All Instructions And Warnings Prior To Installation Of System And Operation Of Vehicle.



THANK YOU

Your truck is about to be fitted with the best suspension system on the market today. That means you will be driving the baddest looking truck in the neighborhood, and you'll have the warranty to ensure that it stays that way for years to come. Thank you for choosing BDS Suspension!

BEFORE YOU START

BDS Suspension Co. recommends this system be installed by a professional technician. In addition to these instructions, professional knowledge of disassembly/ reassembly procedures and post installation checks must be known.

FOR YOUR SAFETY

Certain BDS Suspension products are intended to improve off-road performance. Modifying your vehicle for off-road use may result in the vehicle handling differently than a factory equipped vehicle. Extreme care must be used to prevent loss of control or vehicle rollover. Failure to drive your modified vehicle safely may result in serious injury or death. BDS Suspension Co. does not recommend the combined use of suspension lifts, body lifts, or other lifting devices. You should never operate your modified vehicle under the influence of alcohol or drugs. Always drive your modified vehicle at reduced speeds to ensure your ability to control your vehicle under all driving conditions. Always wear your seat belt.

BEFORE INSTALLATION

- Special literature required: OE Service Manual for model/year of vehicle. Refer to manual for proper disassembly/reassembly procedures of OE and related components.
- Adhere to recommendations when replacement fasteners, retainers and keepers are called out in the OE manual.
- Larger rim and tire combinations may increase leverage on suspension, steering, and related components. When selecting combinations larger than OE, consider the additional stress you could be inducing on the OE and related components.
- Post suspension system vehicles may experience drive line vibrations. Angles may require tuning, slider on shaft may require replacement, shafts may need to be lengthened or trued, and U-joints may need to be replaced.
- Secure and properly block vehicle prior to installation of BDS Suspension components. Always wear safety glasses when using power tools.
- If installation is to be performed without a hoist, BDS Suspension Co. recommends rear alterations first.
- Due to payload options and initial ride height variances, the amount of lift is a base figure. Final ride height dimensions may vary in accordance to original vehicle attitude. Always measure the attitude prior to beginning installation.



Visit 560plus.com for more information.

TIRES AND WHEELS

3" Kit:

- 35x12.50 on 17, 18, 20x9 5.5-5.75"BS
- 295/60 on 20x9 5-5.75" BS
- 285/65 on 20x9 5-6.18" BS
- 285/70 on 18x9 5-6.18" BS
- 285/75 on 17x9 5-6.18" BS

Stock wheels and stock tires can be installed, but are tight to the ball joint cup

BEFORE YOU DRIVE

Check all fasteners for proper torque. Check to ensure for adequate clearance between all rotating, mobile, fixed, and heated members. Verify clearance between exhaust and brake lines, fuel lines, fuel tank, floor boards and wiring harness. Check steering gear for clearance. Test and inspect brake system.

Perform steering sweep to ensure front brake hoses have adequate slack and do not contact any rotating, mobile or heated members. Inspect rear brake hoses at full extension for adequate slack. Failure to perform hose check/ replacement may result in component failure. Longer replacement hoses, if needed can be purchased from a local parts supplier.

Perform head light check and adjustment.

Re-torque all fasteners after 500 miles. Always inspect fasteners and components during routine servicing.

CONTENTS OF YOUR KIT

011310 - Front Box Kit

Part #	Qty	Description
A365	1	2020+ GM 2500 / 3500 HD Control Arm - DRV
A366	1	2020+ GM 2500 / 3500 HD Control Arm - PASS
02911	2	Ball Joint Cap
9452K145	2	O Ring
01499	8	1/4in Spacer
353	2	Bolt Pack - Shock Spacer
	2	1/2"-13 x 1-3/4" Bolt, Grade 5, Clear Zinc
	2	1/2"-13 NyLock Nut, Clear Zinc
	2	1/2" SAE Washer, Clear Zinc
03468	2	Torsion Bar Bolt Keepers
75	4	1.25 x 5/16 x .50 DOM Sleeve
73	2	1.25 x 5/16 x .875 DOM Sleeve
679	1	Bolt Pack - Differential Drop
	2	9/16"-12 x 5" Bolt, Grade 8, Yellow Zinc
	2	9/16"-12 x 5-1/2" Bolt, Grade 8, Yellow Zinc
	8	9/16" SAE Washer, Yellow Zinc
	4	9/16"-12 Prevailing Torque Nut, Yellow Zinc
882	1	Bolt Pack - 2020 HD 3In Kit
	10	10mm-1.50 x 30mm Bolt, Class 10.9, Clear Zinc
	6	3/8" USS Washer, Clear Zinc
	4	3/8"-16 x 1-1/4" Bolt, Grade 8, Yellow Zinc
	4	3/8" SAE Washer, Yellow Zinc
	4	3/8"-16 Prevailing Torque Nut, Yellow Zinc
342701	1	Thread Locker
03917	2	2020+ GM HD Torsion Key
03953	2	2020+ GM HD Sway Bar Relocation Bracket

011218 - Rear Box Kit (Non-Overload)

Part #	Qty	Description
2FB18	2	2in Flat Block - M18 Pin
343251350QB	4	3/4 x 3-1/4 x 13-1/2 Square U-bolt
N34FLG-B	8	3/4"-10 Serrated Flange Nut
099000	2	11.5in Nylon Cable Tie - Black

011217 - Rear Box Kit (With Overload)

Part #	Qty	Description
2FB18	2	2in Flat Block - M18 Pin
343251550QB	4	3/4 x 3-1/4 x 15-1/2 Square U-bolt
N34FLG-B	8	3/4"-10 Serrated Flange Nut
099000	2	11.5in Nylon Cable Tie - Black

1. Disassembly/assembly of the factory torsion bar system requires the use of a special unloading tool. The GM specified tool # is CH48809.
2. Compatible with gas or diesel models as well as standard or AT4 models.
3. Some minor trim will be required with certain wheel/tire combination. This is normal with most aftermarket tire/wheel fitment on Chevy/GM trucks. Trimming will normally included the bottom edge of the inner fender shrouds and/or lower corner of front bumper valance. As a rule of thumb, deeper backspacing and shorter/narrower tires will reduce/eliminate trimming required. Further trimming tips are included at the end of this instruction sheet.
4. For replacement ball joints use service kit BDS081203. Ball joint is directional and must be installed with the 'dot' facing either inward or outward on the vehicle, otherwise damage may occur.



**TECH
TIPS**

INSTALLATION INSTRUCTIONS

FRONT INSTALLATION

SPECIAL TOOLS

Torsion Bar Unloading tool (see Pre-Installation Note #1)

1. Park the vehicle on a flat, clean surface and block the rear wheels for safety.
2. Raise the front of the vehicle and support with jack stands under the frame rails.
3. Remove the wheels.
4. Measure and record the length of the exposed thread on the torsion bar adjuster bolts (Fig. 1). Record the lengths here for use later during the installation

DRV Side: _____ PASS Side: _____

FIGURE 1



5. Unload the torsion bars but do not remove. Remove and save adjuster bolt/retainer block.



Tip Torsion bars are under extreme pressure. A proper torsion bar tool is necessary to unload the bars. A tool designed specifically for GM torsion bars is required see troubleshooting note #2.

6. Mark the unloaded torsion bars to indicate DRV side and PASS side. Also mark the bars to indicate front versus rear.
7. Remove the torsion bar adjuster key by pushing the torsion bar forward to allow the key to drop free. On some vehicles this will require using a hammer/punch or air hammer. Access the end of the torsion bar through the hole in the back of the torsion bar cross member and drive forward. Leave the torsion bars in the lower control arms.
8. Slide the torsion bars forward to allow the factory keys to be removed. On older vehicles, it may be necessary to use an air hammer to get the bars to break free.

FIGURE 2

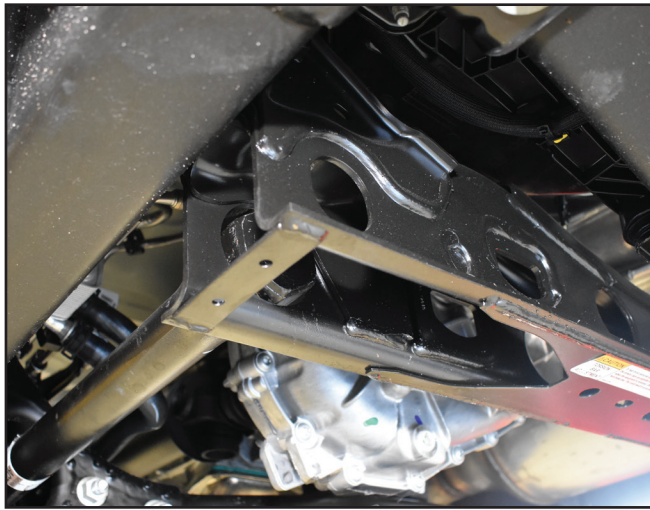

9. Remove the factory front and differential skid plates. Save the skid plates and hardware for later installation.

SHOCK AND UPPER CONTROL ARM INSTALLATION

10. Remove the upper shock nuts and lower shock bolt. Remove shocks from vehicle.
11. Remove the upper ball joint nut, reinstall a couple of turns. Hit the side of the knuckle to dislodge the upper ball joint from the steering knuckle. Remove the factory upper control arm from the vehicle. (Figure 3, 4)

FIGURE 3



FIGURE 4

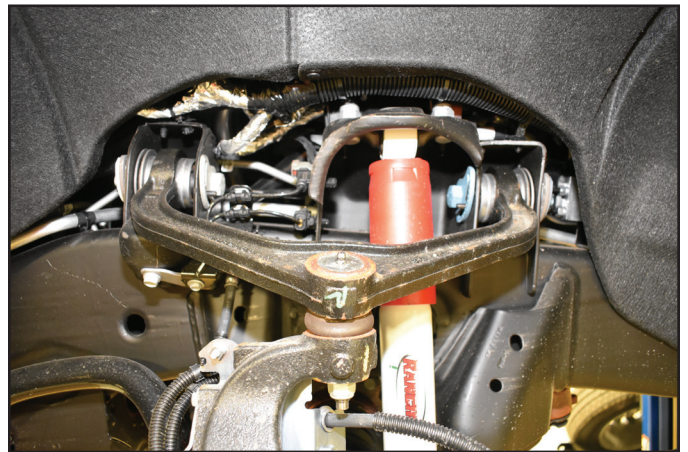

12. Install new upper control arm assembly with factory cam bolts. Arms are side specific. Snug, but do not tighten at this time. Attach the upper ball joint to the steering knuckle with provided nut, washer, and cotter pin. Tighten the upper ball joint nut to 37 ft-lbs on the first pass and a final pass of 90-110 degrees. Install the cotter pin (do not loosen the nut to line up the cotter pin hole).

Note: The new upper control arms will have additional clearance to the droop limiter on the front control arm pocket (Figure 5). Verify the correct UCA is installed on the correct side by the raised area around the droop limiter.

FIGURE 5

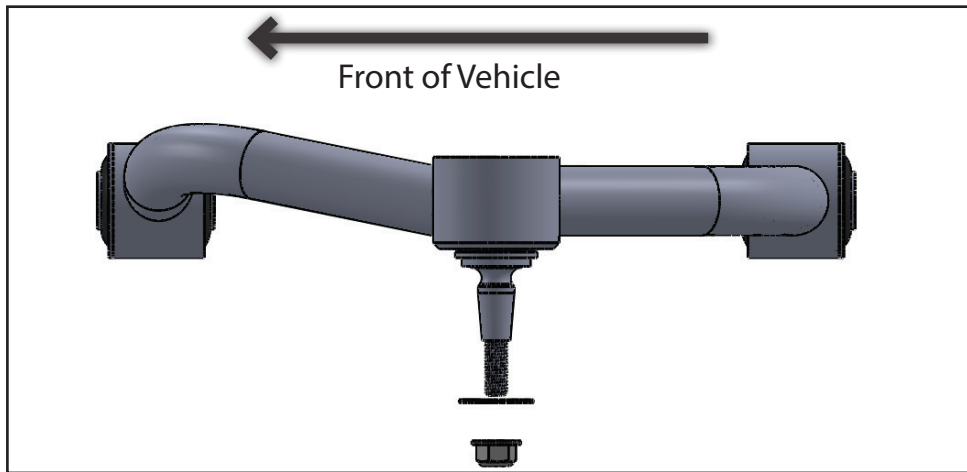

13. **Fox 2.0 Shocks Only:** Install the provided front shocks using the provided 1/4" spacer between the bar pin and frame. **Fox 2.5 Shocks do not install the 1/4" spacers.** Attach to the frame using the new provided bolt pack 353. Figure 6A shows an example of where the spacer goes.

FIGURE 6A

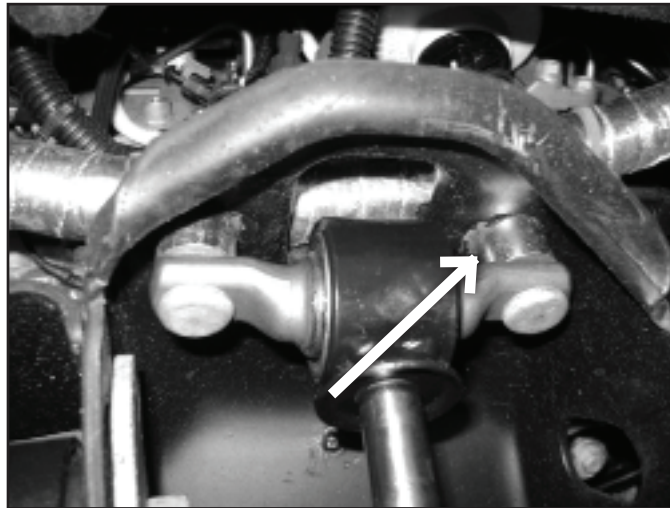
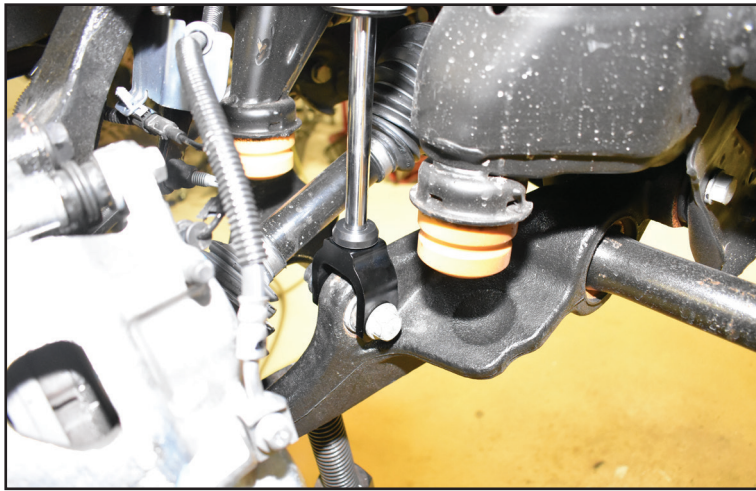

FIGURE 6B



14. Attach the lower shock mount to the lower control arm with factory bolt and nut. Leave lower shock bolt loose. This will be tightened with the weight of the vehicle.

FIGURE 7



15. Torque the upper shock hardware to 60 ft-lbs.

DIFFERENTIAL DROP INSTALLATION

16. Work on one side of the vehicle at a time. Remove the hardware that attaches the differential mounts to the frame. (Figure 7)

FIGURE 8

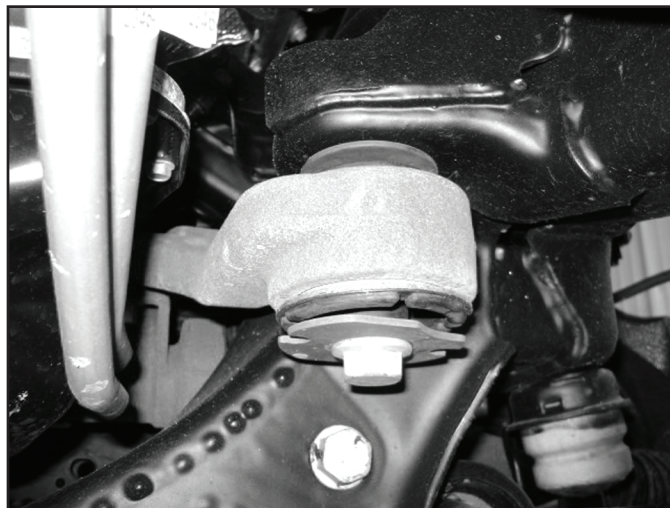

17. Lower the differential and install the spacers between the frame mounting points and the factory brackets. Use the short 1/2" tall spacer at the rear mount with 9/16" x 5" hardware from Bolt Pack 679. Use the tall 7/8" spacer at the front mount with 9/16" x 5-1/2" hardware. (Figure 9A & B). Torque the 9/16" hardware to 118 ft-lbs.

FIGURE 9A

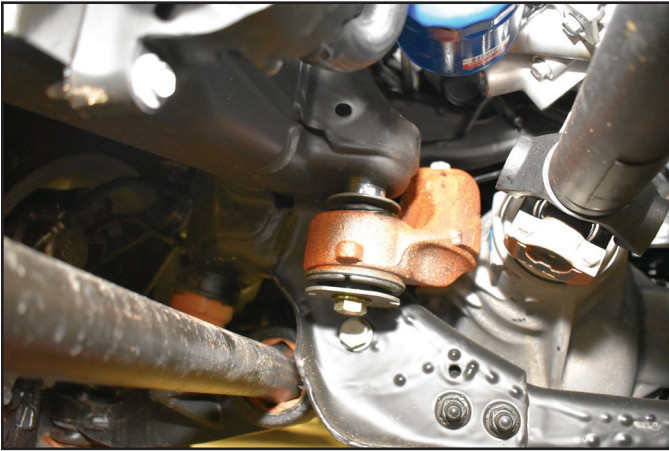
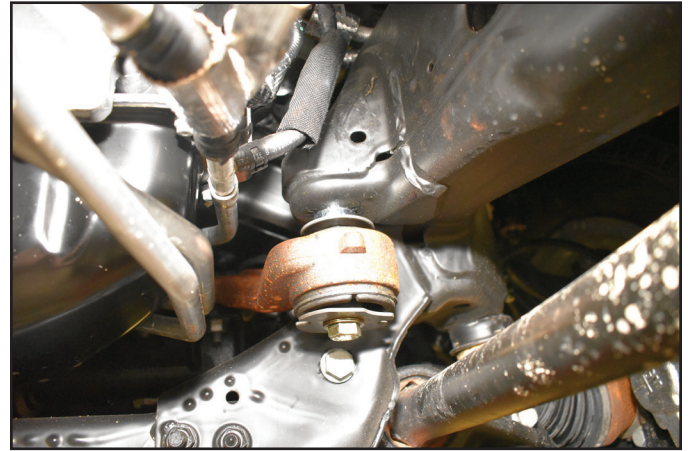

FIGURE 9B



SWAY BAR OFFSET BRACKET

18. Remove the four bolts attaching the sway bar to the frame and discard the factory hardware. Allow the sway bar to swing out of the way.
19. Install two of the 3/8" x 1-1/4" bolts from Bolt Pack 882 into a sway bar relocation bracket. The 3/8" bolts will install with no washer into the slots in the sway bar relocation bracket to lock the rotation of the bolts.
20. Attach the sway bar relocation to the frame using the provided 10mm x 30mm bolts and thread locker, do not use a washer. The relocation needs to offset the sway bar forward in the vehicle. Torque 10mm hardware to 37ft-lbs.
21. Attach the sway bar to the relocation brackets with the 3/8" nuts and 3/8" SAE washers. Torque 3/8" hardware to 37 ft-lbs.

FIGURE 10



SKID PLATE INSTALLATION

22. Install the 1/4" spacer washers between the front skid plate and frame and attach using two of the 10mm x 30mm bolts and 3/8" USS Washers from Bolt Pack 882. Torque hardware to 15 ft-lbs.

FIGURE 11

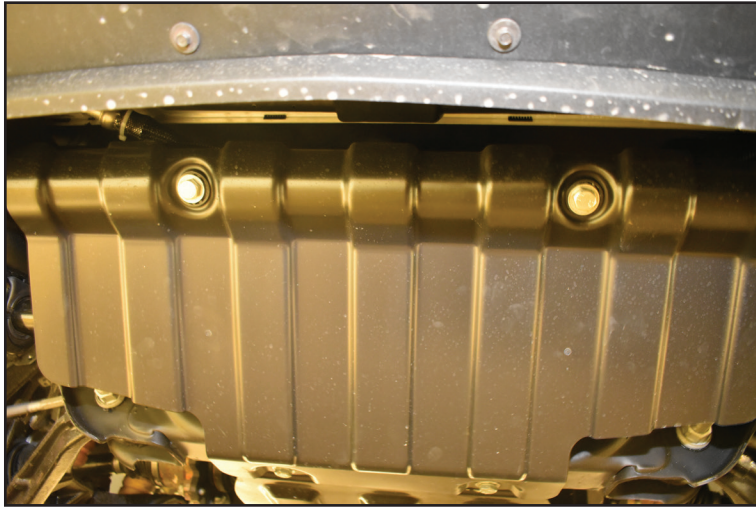

23. Install the 1/4" spacer washers between the front & differential skid plate and front frame cross member and attach using two of the 10mm x 30mm bolts and 3/8" USS Washers. Torque hardware to 15 ft-lbs.

FIGURE 12

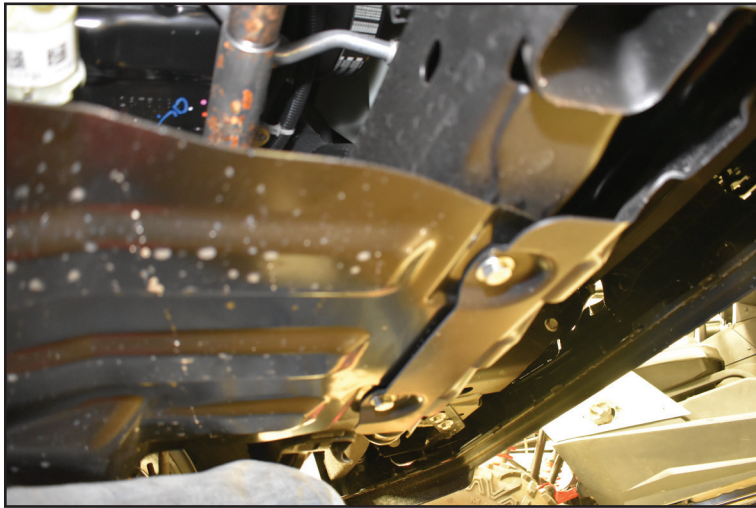

24. Install the 1/2" spacer washers between the differential skid plate and rear frame cross member and attach using (2) of the 10mm x 30mm bolts and 3/8" USS Washers. Torque hardware to 15 ft-lbs.

FIGURE 13

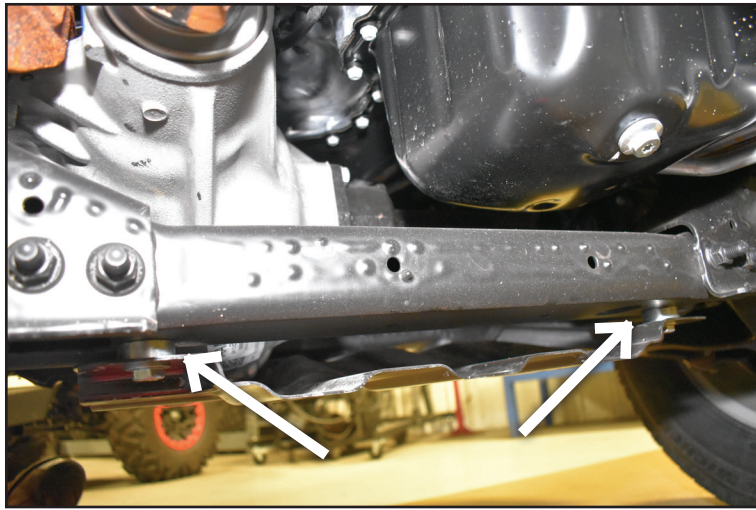

TORSION KEY INSTALLATION

25. Install the torsion bar adjusting bolt retainer onto the end of the torsion key. This will keep the bolt centered on the torsion key when loaded. (Fig 14) It may be necessary to grind the flashing on the parting line of the key casting to get the bolt retainer to stay in place or the retainer can be tapped onto the key with a hammer. The retainer should be centered on the arched area of the torsion key.

FIGURE 14



FIGURE 15

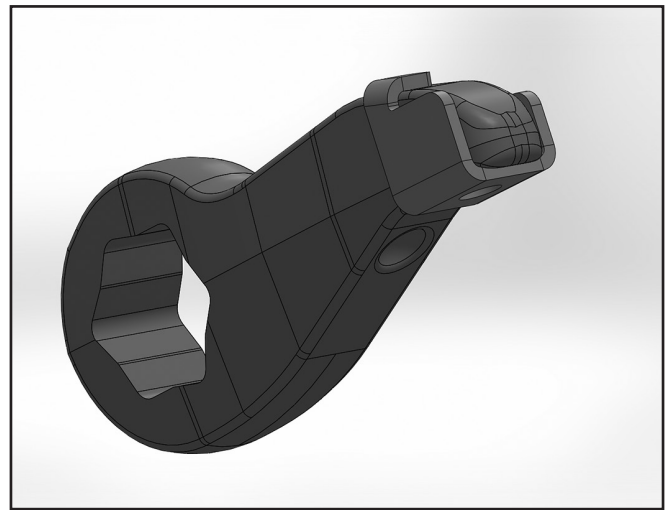

26. Apply a small amount of grease to the hex on each end of the torsion bar. Install the new torsion keys. When installed the keys should be nearly horizontal and pointing toward each other. Because of slight differences in hex shape, the factory and Zone keys will appear to have very similar indexing.
27. Install the torsion bar adjuster assembly with torsion bar tool. Make sure the bolt goes into the torsion bar bolt retainer installed previously.
28. Set the overall length of the exposed thread and bolt head to the original measurement. The minimum recommended length is 3/4". This may need to be adjusted if heavy accessories are added to the front of the vehicle.

FIGURE 16



29. Reinstall the wheels and lower the vehicle to the ground. Torque lug nuts to 140 ft-lbs in a crossing pattern
30. Roll the vehicle forward and back to settle the suspension.
31. Check the final ride height measurement. This should not be more than 27-1/2". If it is greater than this, the adjusters need to be lowered.
32. Torque the lower shock mount bolt to 89 ft-lbs.
33. Center the upper control arm cams. Tighten the cam bolts to 192 ft-lbs.
34. Check all hardware for proper torque.
35. A front end alignment must now be performed.
36. Check hardware after 500 miles. Adjust headlights.

REAR INSTALLATION

37. Block the front wheels for safety. Raise the rear of the vehicle and support with jack stands under the frame rails, just ahead of the front leaf spring hangers.
38. Remove the wheels.
39. Raise rear of vehicle and support frame with jackstands.
40. Support the rear axle with a hydraulic jack.
41. Disconnect the rear shocks from the axle and frame end. Discard the rear shocks. Save hardware.
42. With the axle well supported, remove the passenger's side u-bolts and lower u-bolt plate. Loosen, but do not remove the u-bolt hardware on the driver's side. This will allow the axle to move more easily and aid in installation. Check slack on any brake lines or ABS lines.

2" LIFT BLOCK INSTALLATION

43. Install the new blocks between the axle and the leaf spring. Align the pins/holes and raise the axle to seat the assembly. Install the new provided u-bolts with the factory u-bolt plate. (Figure 17) Fasten with the provided locking flange nuts. Snug hardware. Final torque will be down with the vehicle on the ground.

FIGURE 17

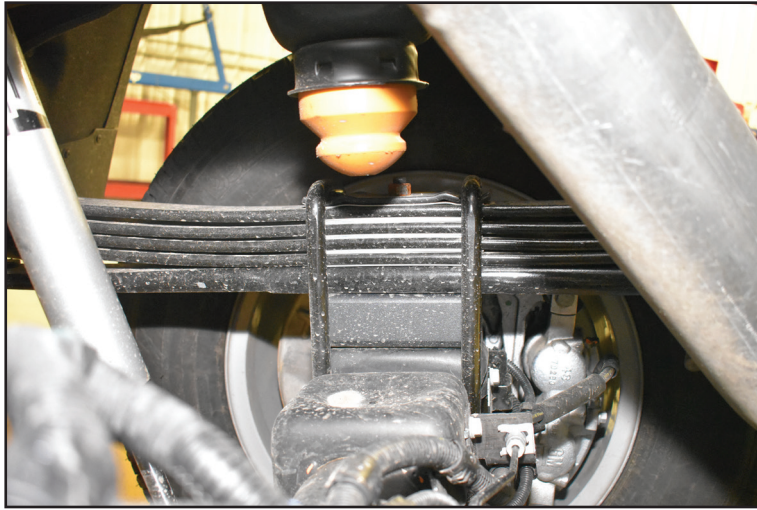

44. Repeat block installation of the driver's side.
45. Check all cables for adequate slack at full droop, make adjustments if necessary.

FIGURE 18

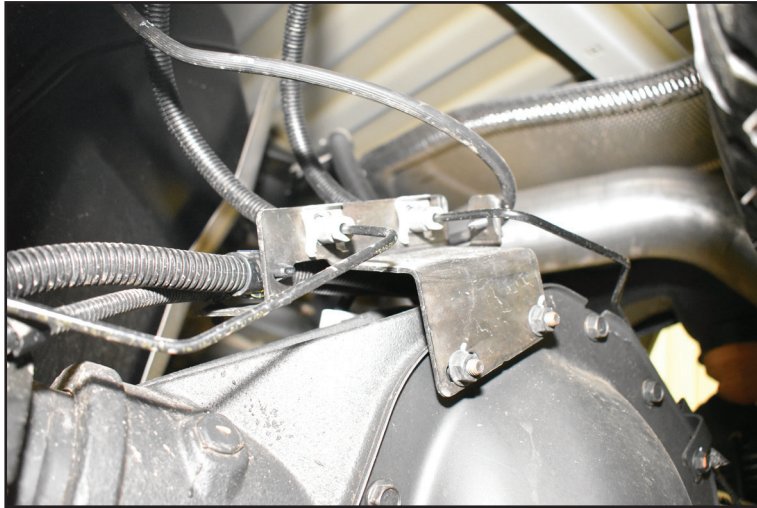

46. Attach the new shocks to the axle and frame with factory hardware. Torque hardware to 85 ft-lbs.

FIGURE 19



47. If installed remove clips on wheels (Figure 20). Reinstall wheels and lower vehicle to the ground.

FIGURE 20

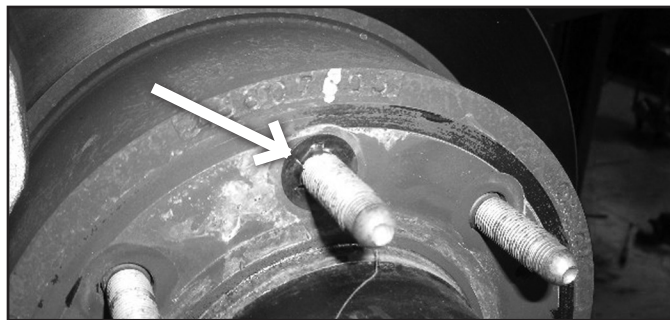

48. Reinstall the wheels and lower the vehicle to the ground. Torque lug nuts to 140 ft-lbs in a crossing pattern
49. Roll the vehicle forward and back to settle the suspension.
50. Torque u-bolts to 150 ft-lbs.

POST-INSTALLATION

51. Check all hardware for proper torque.
52. Reconnect the positive and negative battery cables.
53. The vehicle will need a complete front end alignment.
54. Check all hardware after 500 miles.
55. Adjust headlights.



WE WANT TO SEE YOUR RIDE!

Grab photos of your BDS-equipped truck in action and send them in for a chance to be featured. Send it in to our Bad Ass Rides customer gallery at bds-suspension.com/bar and post them on the BDS Fan Page on Facebook at facebook.com/BDSSuspensions. Don't forget about your BDS swag! BDS offers t-shirts, hoodies, decals and more available on the BDS website or through your local BDS distributor.

TIME TO HAVE SOME FUN

Thank you for choosing BDS Suspension.

For questions, technical support and warranty issues relating to this BDS Suspension product, please contact your distributor/installer before contacting BDS Suspension directly.